



**CONTINUAL ASSESSMENT 1
PRIMARY 5**

SCIENCE

BOOKLET A

THURSDAY

5 MARCH 2015

1 HOUR

Name : _____ . ()

Class : P5 _____

INSTRUCTIONS TO PUPILS

DO NOT TURN OVER THE PAGES UNTIL YOU ARE TOLD TO DO SO

Follow all instructions carefully.

There are 15 questions in this booklet.

Answer **ALL** questions.

INFORMATION FOR PUPILS

The total marks for this booklet is 30.

The total time for Booklets A and B is 1 hour.

This question paper consists of 9 printed pages (inclusive of cover page).

Booklet A (30 marks)

For each question from 1 to 15, four options are given. One of them is the correct answer. Make your choice (1, 2, 3 or 4). Shade your answer on the Optical Answer Sheet. (15 x 2 marks)

1. The classification chart shows some things classified according to certain characteristics.

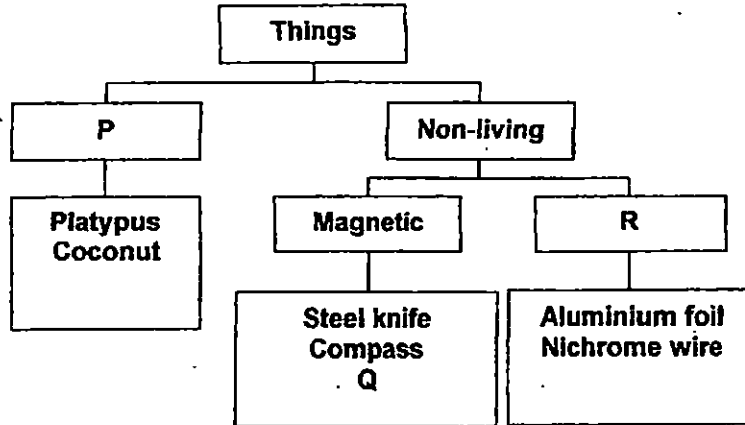

Which of the following correctly represents letters P, Q and R?

	P	Q	R
(1)	Living	Plastic spoon	Non-magnetic
(2)	Non-magnetic	Steel paper clip	Living
(3)	Non-magnetic	Ceramic mug	Living
(4)	Living	Iron nail	Non-magnetic

2. The diagram shows a plant cell. Which of the following parts of the plant cell will enable the plant to make food?

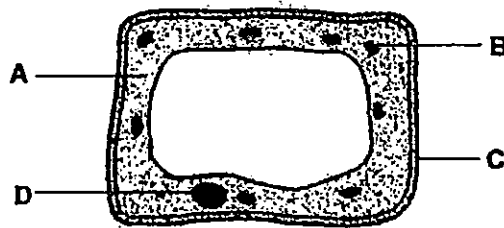

- (1) A
(2) B
(3) C
(4) D

3. Dr Wu took 3 samples of partially digested food from different parts of the digestive system.

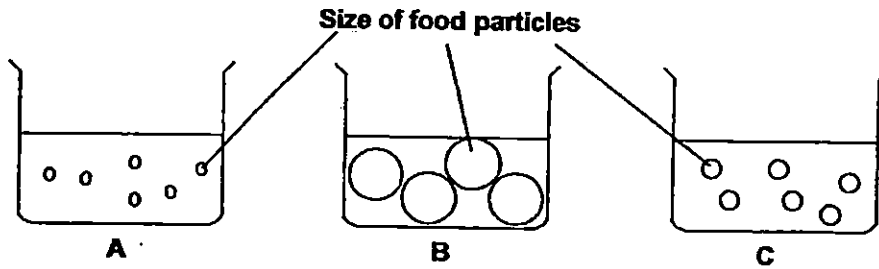

From which parts of the digestive system could A, B and C most likely be taken from?

	A	B	C
(1)	small intestine	mouth	stomach
(2)	small intestine	stomach	mouth
(3)	mouth	stomach	small intestine
(4)	stomach	mouth	small intestine

4. Rachel studied the life cycles of two animals and recorded her observations in the table below.

	Animal A	Animal B
Is there a nymph stage in its life cycle?	Yes	No
Does its young look like its adult?	Yes	No
Can the adult fly?	Yes	Yes
Does it spend part of its life cycle in water?	No	No

Which of the following is correct?

	Animal A	Animal B
(1)	Grasshopper	Butterfly
(2)	Mosquito	Dragonfly
(3)	Cockroach	Grasshopper
(4)	Dragonfly	Mosquito

5. The table below shows the state of four different substances, W, X, Y and Z, at different temperatures.

Substance	State of substance at 20°C	State of substance at 50°C	State of substance at 90°C
W	Liquid	Gaseous	Gaseous
X	Solid	Solid	Liquid
Y	Solid	Liquid	Gaseous
Z	Liquid	Liquid	Liquid

Which substance has the lowest boiling point?

- (1) W
 - (2) X
 - (3) Y
 - (4) Z
6. Which of the following statement(s) is/are true of all plants?

- X Only food-carrying tubes can be found in the stem.
- Y Excess food is stored in the fruits of the plant only.
- Z Water-carrying tubes are found in the different parts of the plant.

- (1) X only
- (2) Z only
- (3) X and Y only
- (4) Y and Z only

7. Which of the following statement(s) about exhaled air is/are correct?

- D It is usually warmer than the inhaled air.
- E It contains more carbon dioxide than oxygen.
- F It contains more water vapour than inhaled air.

- (1) E only
- (2) D and F only
- (3) E and F only
- (4) D, E and F

8. The diagram shows an experiment that Keith conducted in the laboratory.

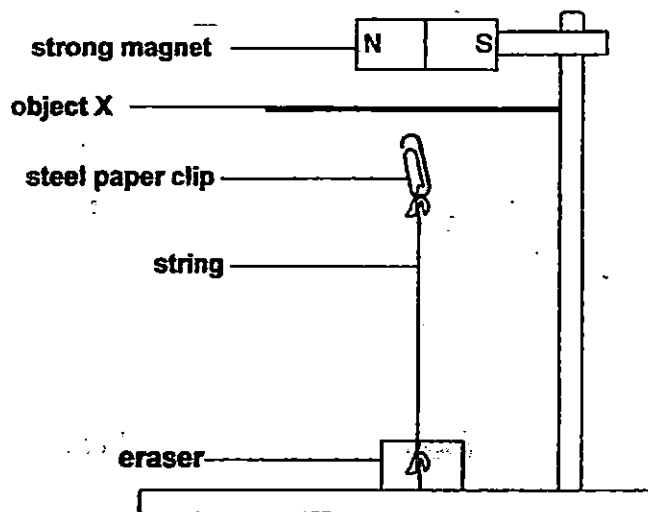

The steel paper clip is able to stay afloat when object X that is 1 mm thick was placed between the magnet and the steel paper clip.

What could Object X be?

- P A nickel sheet
- Q A cobalt sheet
- R A plastic sheet
- S A wooden sheet

- (1) P and Q only
- (2) R and S only
- (3) P and R only
- (4) Q and S only

9. Derek conducted an experiment in a dark room as shown below. He put three different liquids, clear water, cooking oil and murky water, in each beaker. The amount of liquid was the same. The amount of light from the three identical torchlights was also the same.

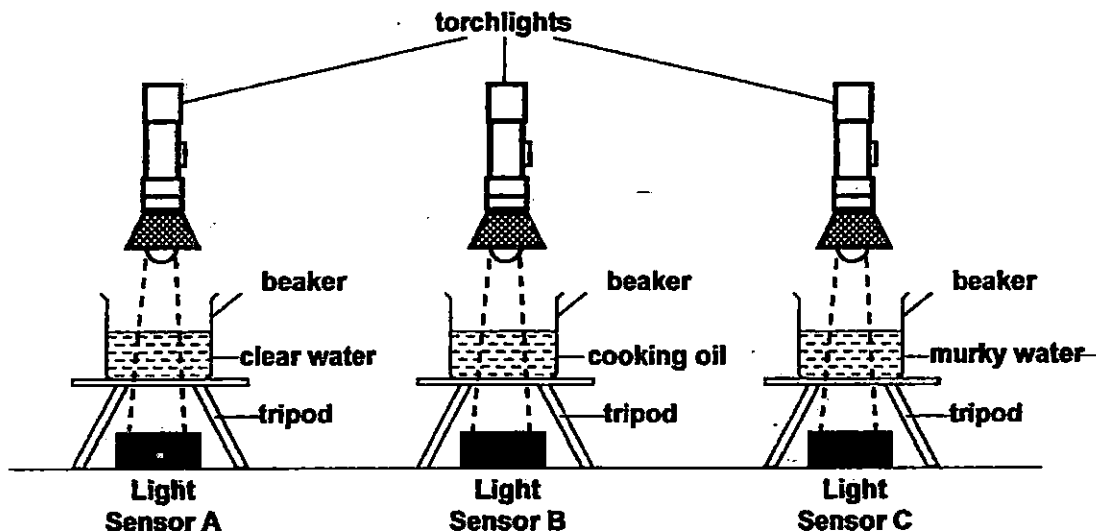

Derek used light sensors to measure the amount of light that passed through each of the three liquids. The unit of light received by the light sensor will be higher when more light reaches the light sensor.

What would be the correct readings from the light sensors?

	Units of light		
	A	B	C
(1)	100	50	70
(2)	100	70	50
(3)	70	50	100
(4)	50	100	70

10. Which of the following statements about the heart are true?

- A The heart pumps blood to all parts of the body.
- B The heart is made of muscles that contract only.
- C The heart receives blood poor in carbon dioxide from the lungs.
- D The heart beats faster when we run as compared to when we sleep.

- (1) B and C only
- (2) B and D only
- (3) A, C and D only
- (4) A, B, C and D

11. Kathy filled 3 similar conical flasks completely with coloured water of the same temperature. She covered each of them with a stopper and a glass tube and placed them into 3 identical beakers. Each beaker contained water of different temperatures. After 20 minutes, she observed that the water level in each glass tube was different as shown below.

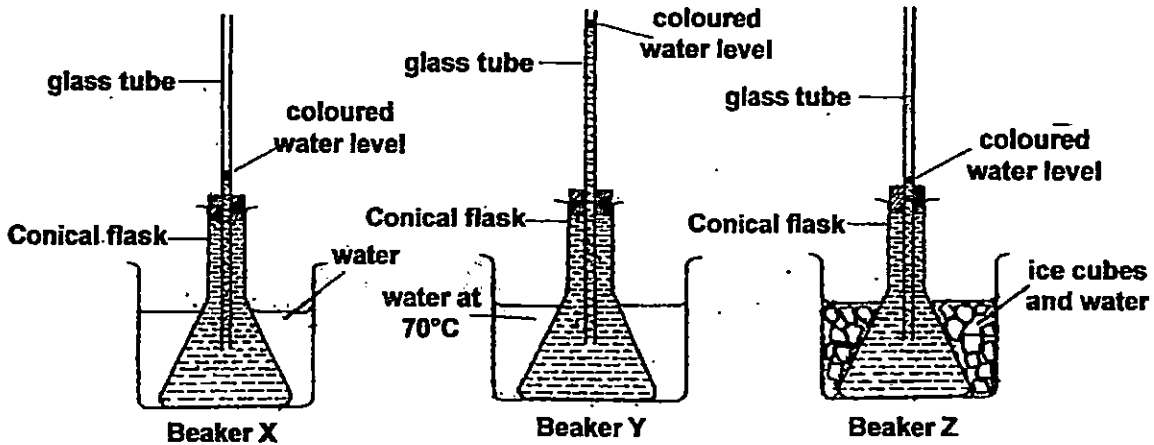

What was the most likely temperature of the water in beaker X?

- (1) 0 °C
 - (2) 12 °C
 - (3) 70 °C
 - (4) 76 °C
12. Sam and his classmates carried out an activity to find out the difference in their chest size during inhalation and exhalation (breathing in and breathing out). The results of the activity are recorded below.

Name	Chest measurement (cm)	
	During inhalation	During exhalation
Sam	82	79
Helen	84	86
Jensen	69	72
Zachary	73	70

Which of the pupils made a mistake during the activity?

- (1) Sam and Helen
- (2) Sam and Zachary
- (3) Helen and Jensen
- (4) Jensen and Zachary

13. The bar graph below shows the amount of oxygen in four blood samples taken from the different blood vessels in the circulatory system.

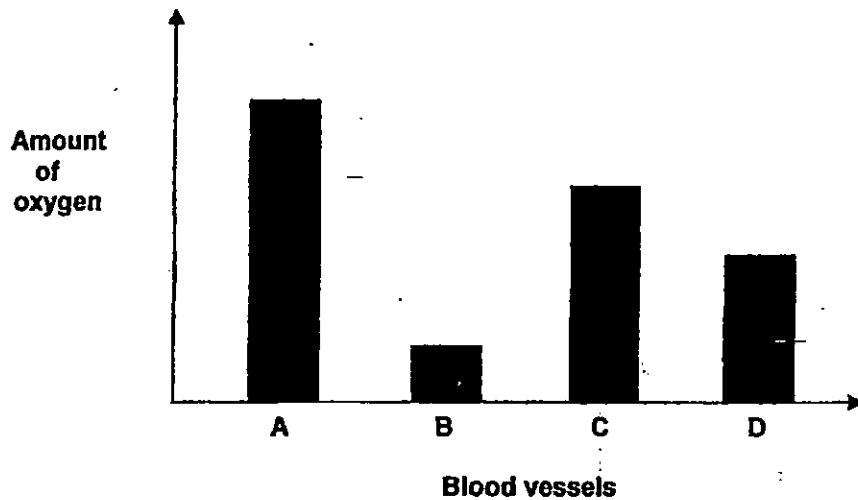

Which blood vessel is most likely to carry blood from the heart to the lungs?

- (1) A
 - (2) B
 - (3) C
 - (4) D
14. Peter removed a ring of food-carrying tubes in a balsam plant. He cut off a portion of the stem of the balsam plant as shown below. After three days, he observed that the upper part of the region that was cut off became swollen.

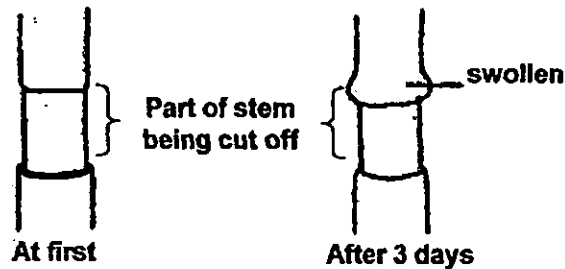

Why was the upper part of the region that was cut off swollen?

- (1) Food made in the leaves gathered at that region.
- (2) Food made in the flowers gathered at that region.
- (3) Water absorbed by the fruit gathered at that region.
- (4) Water absorbed by the roots gathered at that region.

15. Ken analysed cells taken from three different organisms. He recorded the cell parts that were present in each cell in the table below.

A tick (✓) shows the presence of the cell part.

Cell parts	Cell X	Cell Y	Cell Z
Nucleus	✓	✓	✓
Cell wall	✓	✓	
Cytoplasm	✓	✓	✓
Chloroplast		✓	

In which organisms can Cells X, Y and Z be found?

	X	Y	Z
(1)	Balsam	Housefly	Giraffe
(2)	Human	Tiger	Lalang
(3)	Mango	Celery	Elephant
(4)	Platypus	Maple	Parrot

End of Booklet A

ANGLO-CHINESE SCHOOL
(JUNIOR)



CONTINUAL ASSESSMENT 1 (2015)
PRIMARY 5

SCIENCE

BOOKLET B

THURSDAY

5 MARCH 2015

1 HOUR

Name : _____ ()

Class : P5 _____

INSTRUCTIONS TO PUPILS

DO NOT TURN OVER THE PAGES UNTIL YOU ARE TOLD TO DO SO

Follow all instructions carefully.

There are 7 questions in this booklet.

Answer **ALL** questions.

INFORMATION FOR PUPILS

The number of marks is given in brackets [] at the end of each question or part question.

The total marks for this booklet is 20.

The total time for Booklets A and B is 1 hour.

This question paper consists of 8 printed pages (inclusive of cover page).

BOOKLET A	/ 30
BOOKLET B	/ 20
TOTAL	/ 50
Parent's signature/ Date:	

For questions 16 to 22, write your answers in this booklet.

The number of marks available is shown in brackets [] at the end of each question or part question.

16. The flowchart shows the descriptions of some objects.

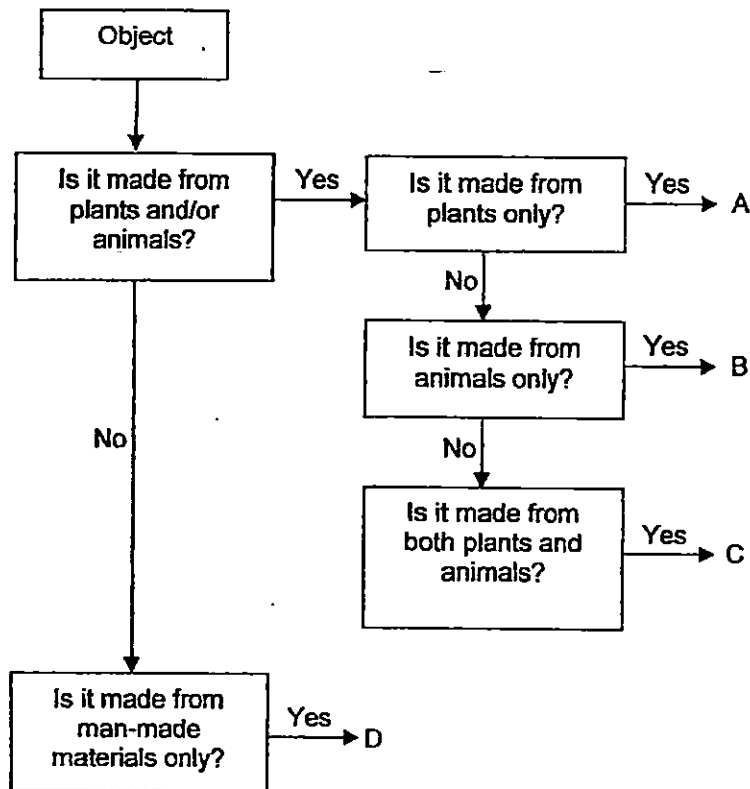

(a) Which letter (A, B, C or D) represents cotton wool and window grilles? [2]

Cotton wool: _____

Window grilles : _____

(b) What is the difference between objects B and C? [1]

(Go on to the next page)

SCORE	3
-------	---

17. Joey had added 5 grams of fertiliser to 900 ml of water in a jar. He stirred the water until all the fertiliser was dissolved. He then placed a balsam plant into the jar as shown in the diagram below.

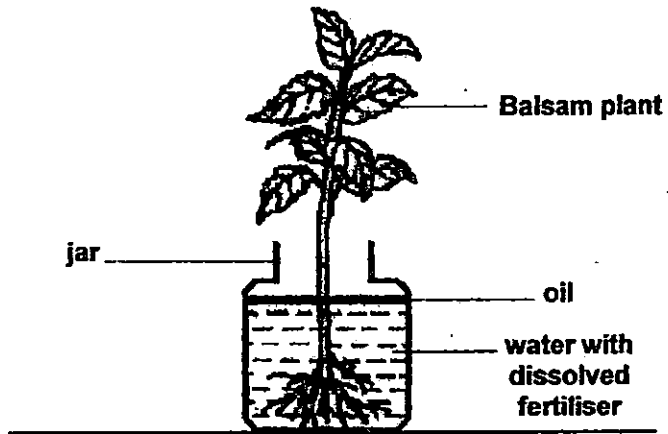

- (a) What would happen to the volume of water in the jar after a week? Put a tick (✓) in the correct box. [1]

Decrease	Increase	Remain the same

- (b) Explain your answer in (a). [1]

(Go on to the next page)

SCORE	2
-------	---

Joan planted a bean seed in a transparent pot. She then observed its growth for the next 6 weeks and drew her observations. The diagrams show her drawings:

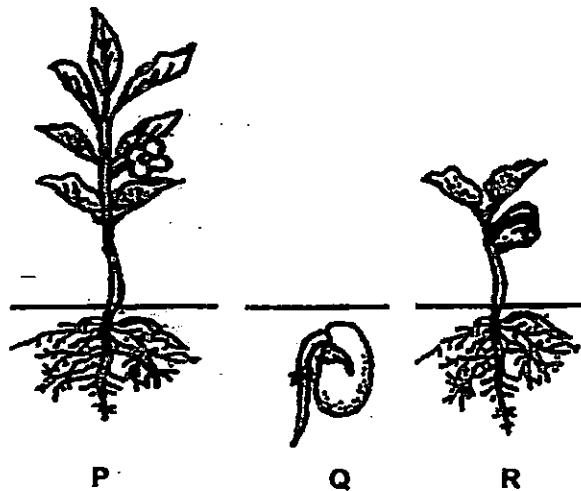

- (a) Arrange Joan's drawings of her observations (P, Q and R) in the correct order beginning with what she observed at first. [1]

- (b) State all the conditions necessary for germination to take place. [1]

- (c) Draw a line graph that shows how the mass of the seed leaves changes over time. [1]

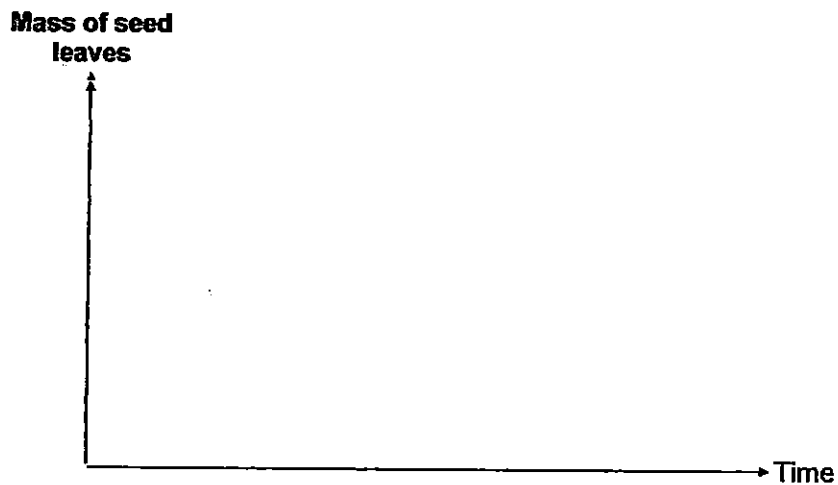

(Go on to the next page)

SCORE	3
-------	---

19. An iron bar becomes an electromagnet when it is placed in a coil of wire joined to batteries. Patrick wants to find out if the number of turns of the coil around the ~~iron~~ steel bar affects the strength of an electromagnet.

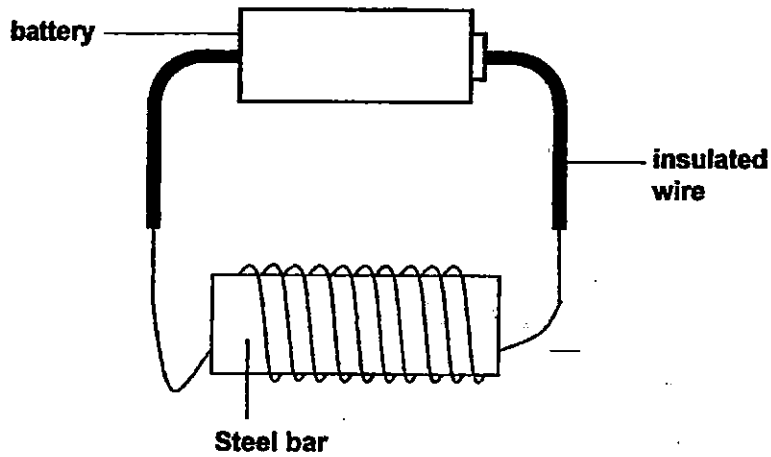

Arrangement	Number of batteries	Number of turns of coil
A	3	10
B	4	20
C	2	10
D	3	30

- (a) Which two arrangements should he set up to carry out his investigation? [1]

- (b) Patrick has placed the same number of identical steel paper clips below each electromagnet to test its strength. What should Patrick observe and record in order to determine the strength of the electromagnet in both arrangements? [1]

- (c) Patrick placed some copper nails below the electromagnet in arrangement D and noticed that the copper nails were not attracted to the electromagnet. Explain why. [1]

(Go on to the next page)

SCORE	3
-------	---

preferred to sit in the shade which is the shadow of the apple tree.

- (a) State the property of light that caused the shadow of the apple tree to be formed. [1]

- (b) Explain clearly how the shadow of the apple tree is formed. [1]

- (c) Larry also observed the shadow of a stick at different times of a day in his garden.

The diagram below shows the shadow of the stick that is formed in the early morning.



Draw the shadow formed by the same stick at 5 p.m. in the box below. [1]

(Go on to the next page)

SCORE	3
-------	---

21. Mary observed some parts of a fish as shown below.

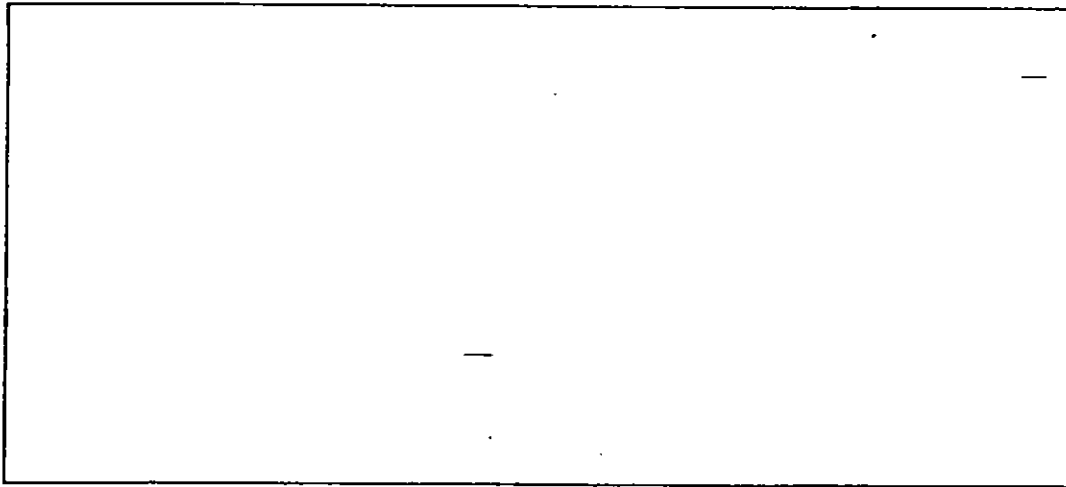

- (a) Label the part of the fish where dissolved oxygen in the water is taken in by the fish. [1]
- (b) Explain clearly how the fish obtains dissolved oxygen in water. [2]

(Go on to the next page)

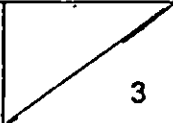
SCORE	
	3

22. The diagram below shows the cross-section of a human heart and the movement of blood.

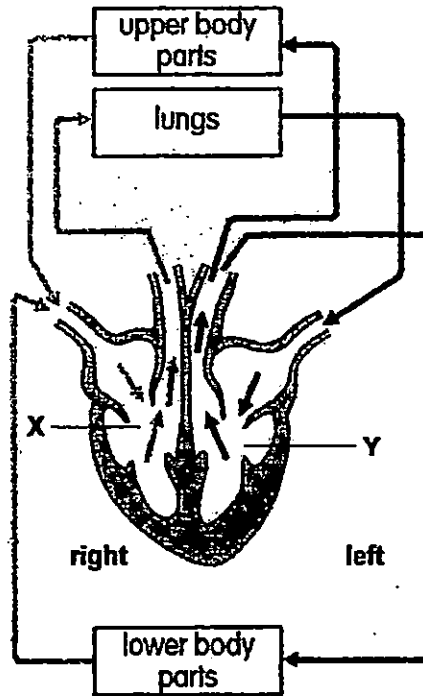

(a) Explain the difference between the blood in X and blood in Y. [1]

(b) Explain why the pulse rate increases as one's activity becomes more vigorous. [2]

End of Paper

SCORE	3
-------	---



EXAM PAPER 2015

LEVEL : PRIMARY 5

SCHOOL : ANGLO – CHINESE SCHOOL (JUNIOR)

SUBJECT : SCIENCE

TERM : CA1

Q1	Q2	Q3	Q4	Q5	Q6	Q7	Q8	Q9	Q10
4	2	1	1	1	2	4	2	2	3
Q11	Q12	Q13	Q14	Q15					
2	3	2	1	3					

Q16a

Cotton wool : (A)

Window grilles : (D)

Q16b. Object B is made from animals only but object C is made from both plants and animals.

Q17a. Decrease

Q17b. The roots of the plant absorb the water.

Q18a. Q, R, P

Q18b. Air, water and warmth

Q18c. SEE PICTURE

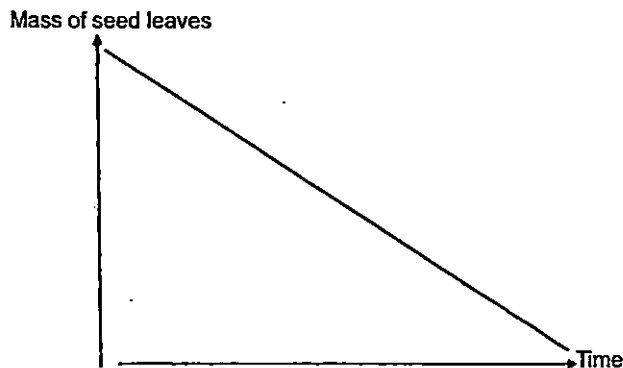

Q19a. (A and D)

Q19b. He should observe and record the number of steel paper clips that each electromagnet can attract.

Q19c. Copper nails are non – magnetic and cannot be magnetized, thus they were not attracted to the electromagnet.

Q20a. Light travels in straight lines .

Q20b. Light from the sun was blocked by the apple tree (opaque object). Thus a shadow is formed.

Q20c. SEE PICTURE

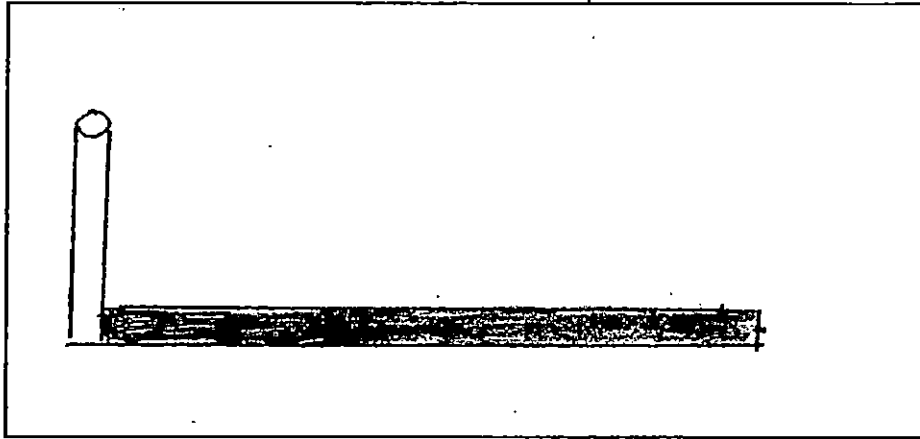

Q21a. SEE PICTURE

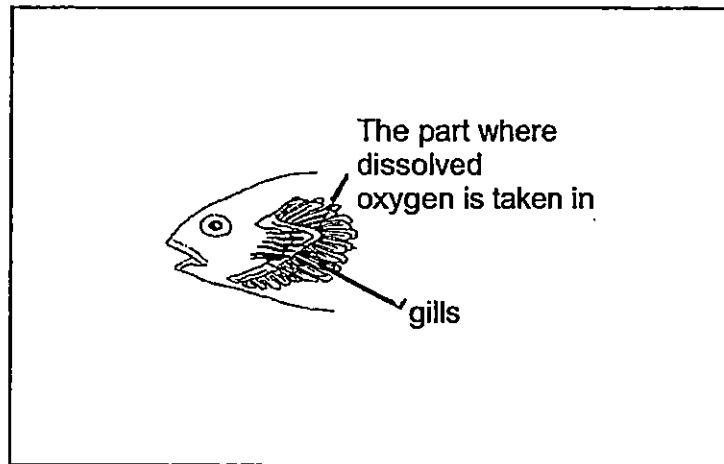

Q21b. Fish takes in water through its mouth. The water washes over / passes through the gills under the gill cover. The gill then absorb the dissolved oxygen in the water / rich supply of blood vessels to absorb dissolved oxygen.

Q22a. Blood in Y is rich in oxygen / oxygenated blood but blood in X is rich in carbon dioxide / deoxygenated blood.

Q22b. The heart has to beat faster to pump more blood / pump blood faster to other parts of the body. Therefore, more oxygen and digested food can be transported to other parts of the body.

THE END