



Maha Bodhi School  
2010 Semestral Assessment 2  
Mathematics

Name : \_\_\_\_\_ (      )

Class: Pr 1

Duration : 1 h 30 min

Date : 1 November 2010

Section A ( 80 marks )	
Section C ( 20 marks )	
Total ( 100 marks )	

Parent's Signature : \_\_\_\_\_

**Section A ( 80 marks )**

Questions 1 to 40 carry 2 marks each.

1. Count and write the number of apples in words.

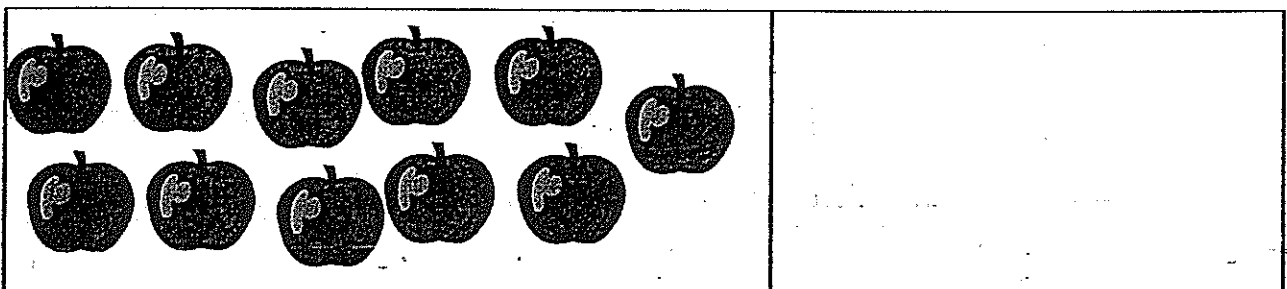

2. Fill in the blanks.

(a) 10 less than 27 is \_\_\_\_\_.

(b)  $35 - \underline{\quad} = 30$

3. Look at the pictures below and complete the addition sentence.

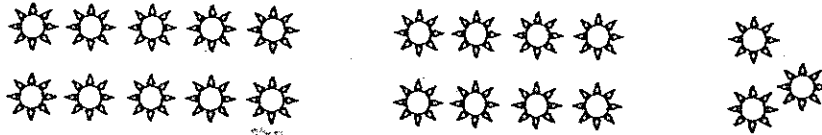

$10 + 8 + \underline{\quad} = \underline{\quad}$

4.

third

Ring the first ball.

5. Study the picture. Fill in the blank with a word.

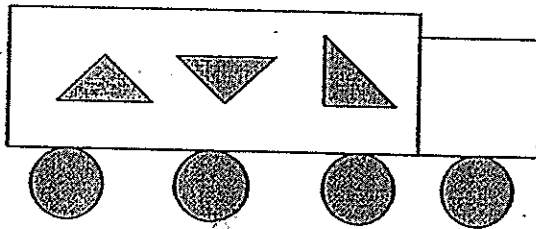

There are 3 \_\_\_\_\_

6. Cross out the numbers greater than sixty-nine.

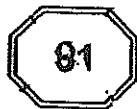
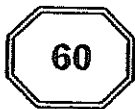

7. Arrange these numbers in order.  
Begin with the smallest.

81	59	98	75
----	----	----	----

\_\_\_\_\_

8. Fill in the blanks.

6 tens 2 ones + 1 ten 8 ones = \_\_\_\_\_

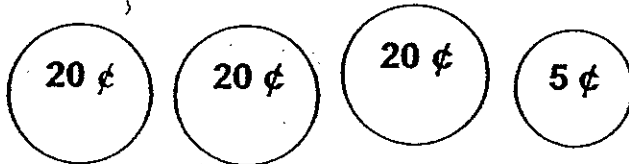

9. Raju bought an eraser with these coins.

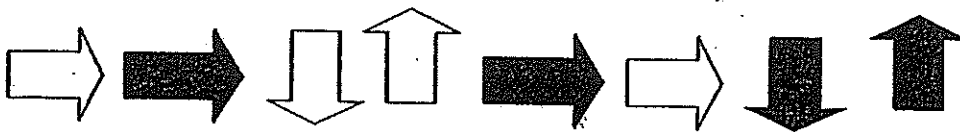

The eraser cost \_\_\_\_\_ ¢.

10. What comes next? Tick (✓) the correct box.

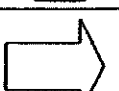

11. Fill in the missing number.

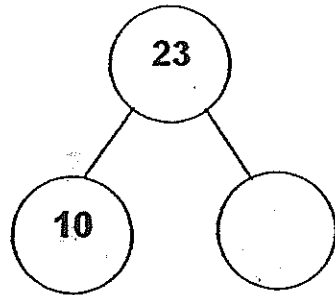

12. Study the number pattern. Then fill in the missing numbers.

                     12, 16, 20

13. Liz is standing in a line. She is fourth from the right and fifth from the left. Where is Liz? Circle the correct figure.

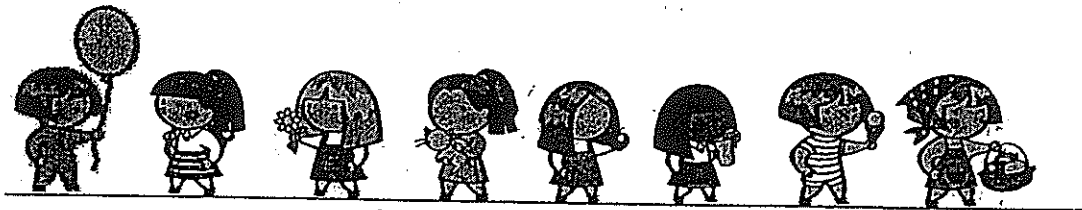

14. There are 12 pencils in Box A.

There are 40 pencils in Box B.

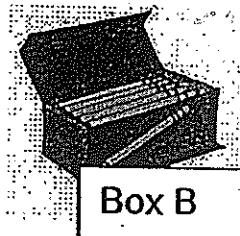
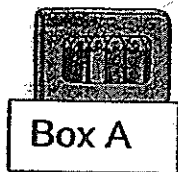

There are \_\_\_\_\_ more pencils in Box B than in Box A.

15. Fill in the blanks.

a)  $11 + 6 = \underline{\hspace{2cm}}$

b)  $25 - 4 = \underline{\hspace{2cm}}$

16. Use the numbers in the box to fill in the blanks.

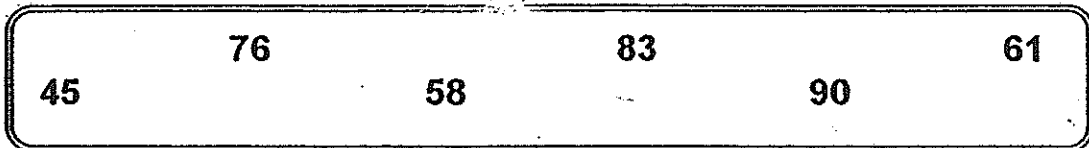

a) 58 is greater than           .

b) 61 and 83 are less than           .

17. Write '+' or '-' in the  $\bigcirc$  so that the answer is correct.

$$\begin{array}{r} 63 \\ \bigcirc 14 \\ \hline 49 \end{array}$$

18. There are 60 children in the hall.

40 of them are boys.

There are            girls in the hall.

19. Colour the notes and coins to show \$32.

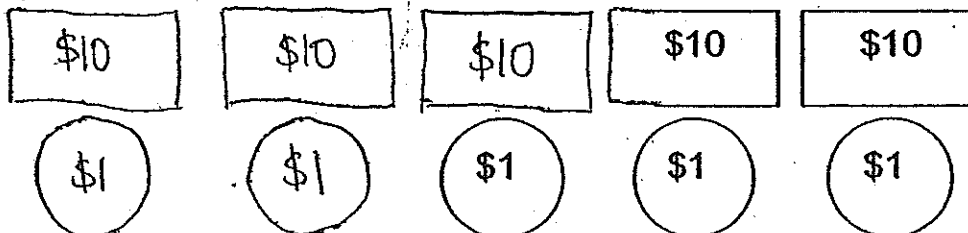

20. Complete the number sentence.

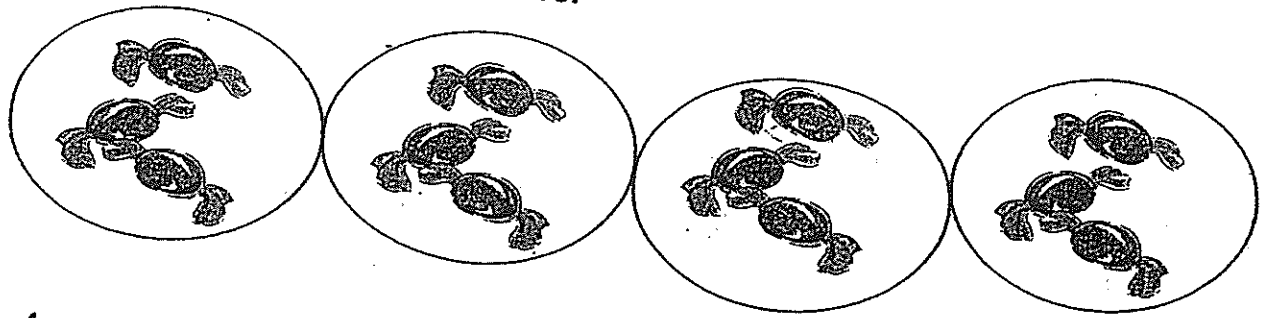

$4 \times \underline{\quad} = \underline{\quad}$

21. Cross out the 2 boxes that have the same answer.

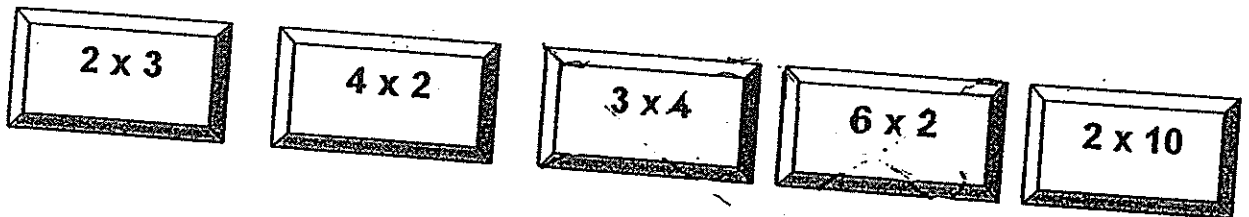

22. A starfish has 5 arms.

7 starfishes have            arms.

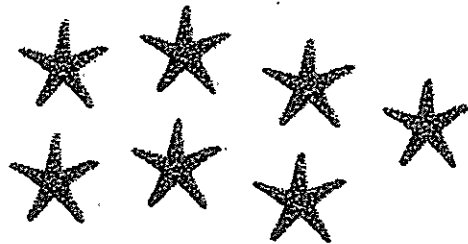

23. Circle the fish below to show 2 equal groups.

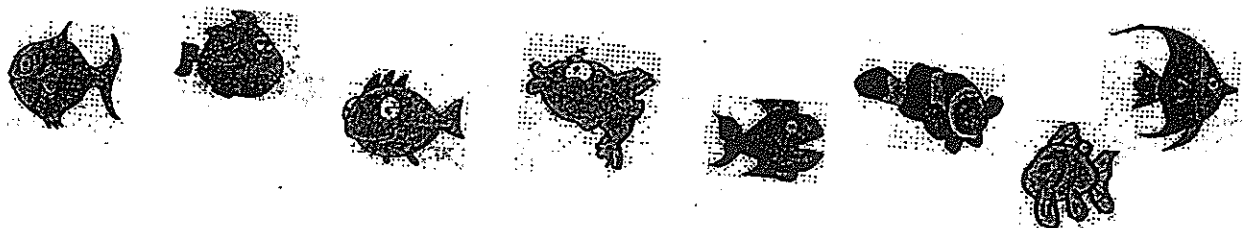

There are            fish in each group.

24. Mr Teo baked 30 cupcakes.  
He put 6 cupcakes in each box.

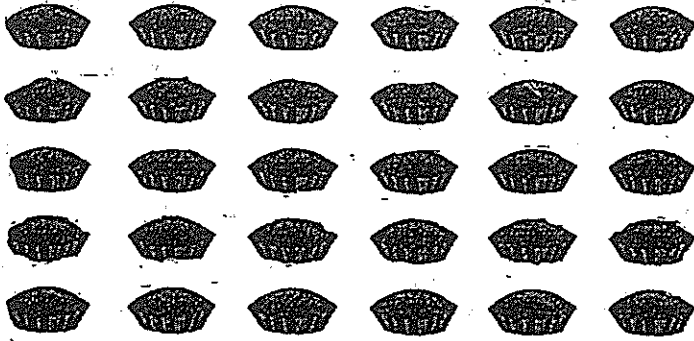

Mr Teo used \_\_\_\_\_ boxes.

25. There are 15 apples.



Draw an equal number of apples on each tray.

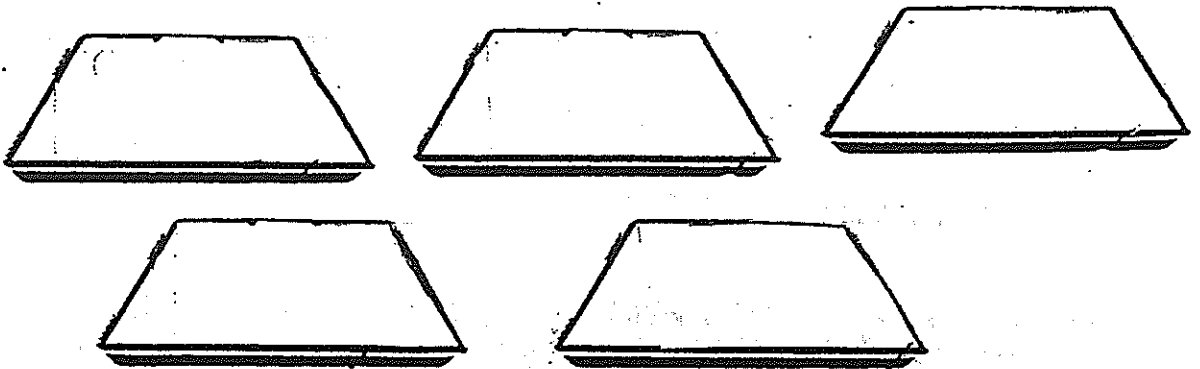

There are \_\_\_\_\_ apples on each tray.

26. My sister wakes up at \_\_\_\_\_ every morning.



27. Four children go to bed at different times every night as shown below.

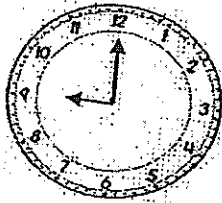

Gurmit

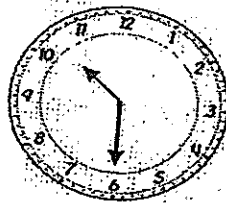

Amy

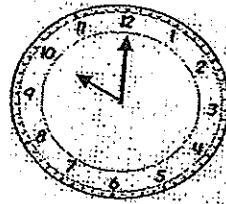

Huiling

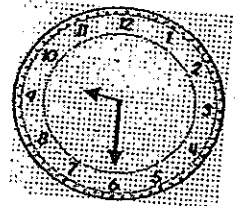

Naji

The first person to go to bed is \_\_\_\_\_ and  
 the last person to go to bed is \_\_\_\_\_.

28. Fill in the number bond with numbers on the umbrella.

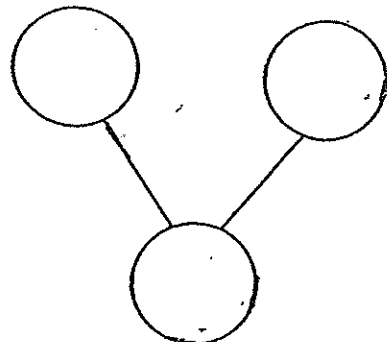
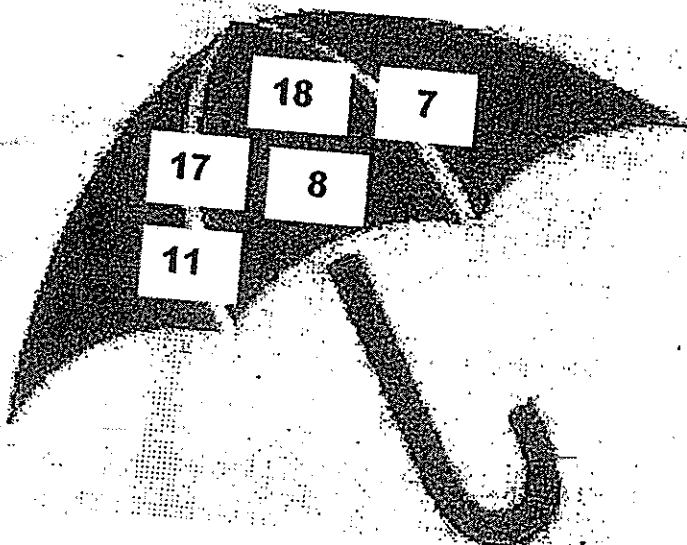



29. Study the pattern. Draw what comes next in the box.

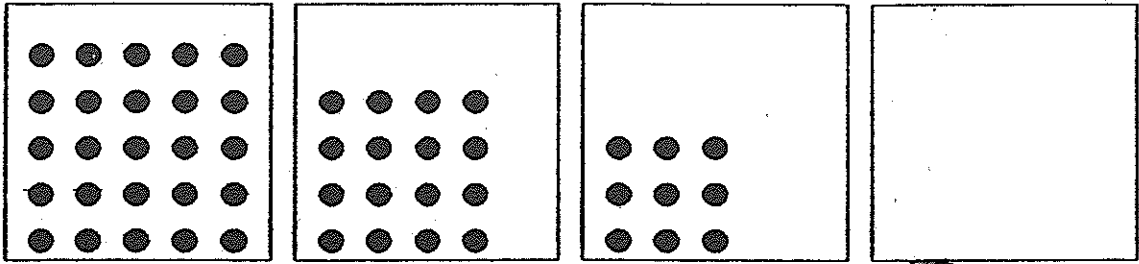

30. Some numbers are missing from the sum below.  
Write the numbers in the boxes.

$$\begin{array}{r}
 9 \quad 2 \\
 - 5 \quad \square \\
 \hline
 \square \quad 3
 \end{array}$$

31. Sarah has 20 marbles.  
Grace has 30 marbles.  
How many marbles must Grace give Sarah  
so that they have the same number of marbles?

Grace must give Sarah \_\_\_\_\_ marbles.

Study the pictures carefully. Then answer questions 32 and 33.

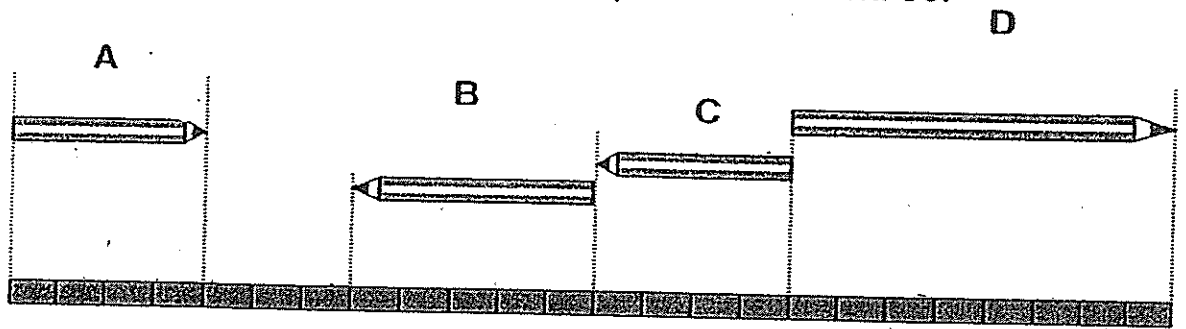

32. Pencil A is as long as Pencil \_\_\_\_\_.

33. Pencil B is \_\_\_\_\_  shorter than the Pencil D.

34. Look at the picture. Use  as 1 unit.

Then fill in the blank.

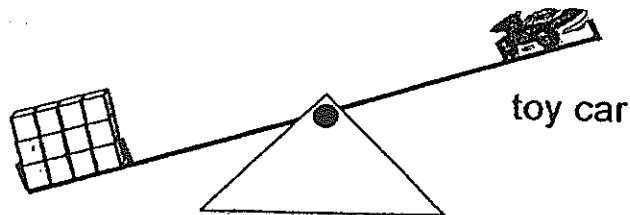

The mass of the toy car is more than 10 units.

The mass of the toy car is \_\_\_\_\_ units.

35. Look at the picture below.

Use  as 1 unit.

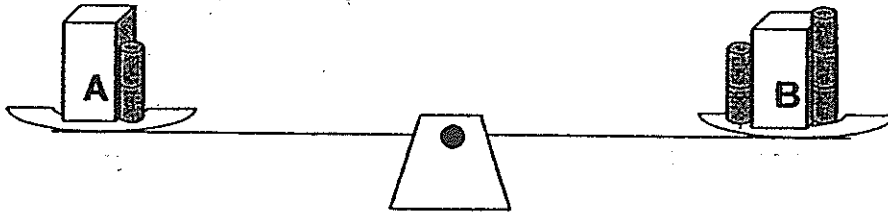

Box A is \_\_\_\_\_ units heavier than Box B.

36. Study the pictures.

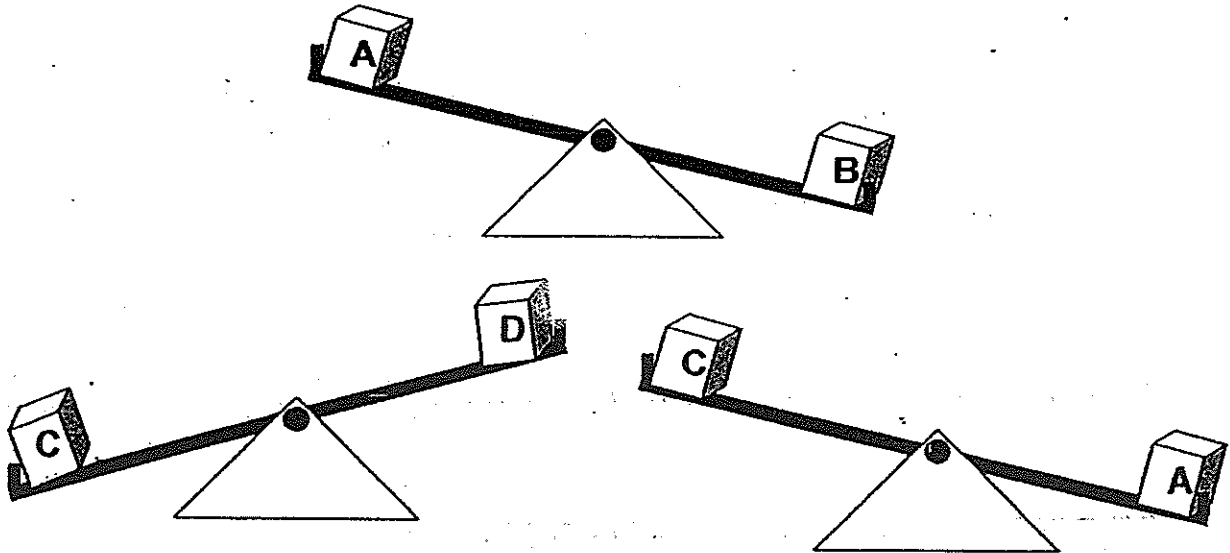

Box \_\_\_\_\_ is the heaviest.

Study the graph below and answer Questions 37 and 38.

### Animals In Furry Pet Shop

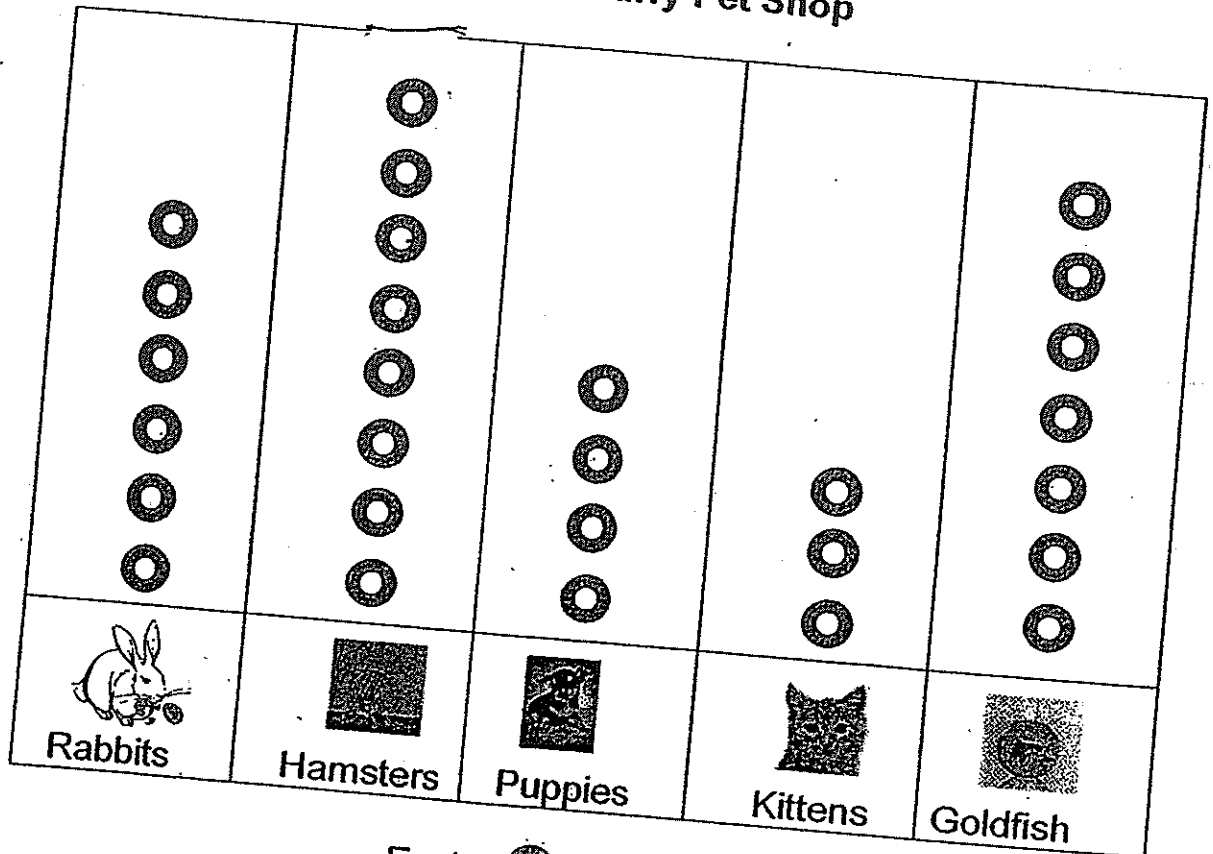

Each  stands for 1 animal.

37. There are \_\_\_\_\_ more hamsters than rabbits.
38. Alice and Mary buy 2 goldfish each from Furry Pet Shop.  
There are \_\_\_\_\_ goldfish left in the pet shop.

39. Study the pattern. The numbers 7, 8 and 9 are missing. Write the missing numbers in the circles.

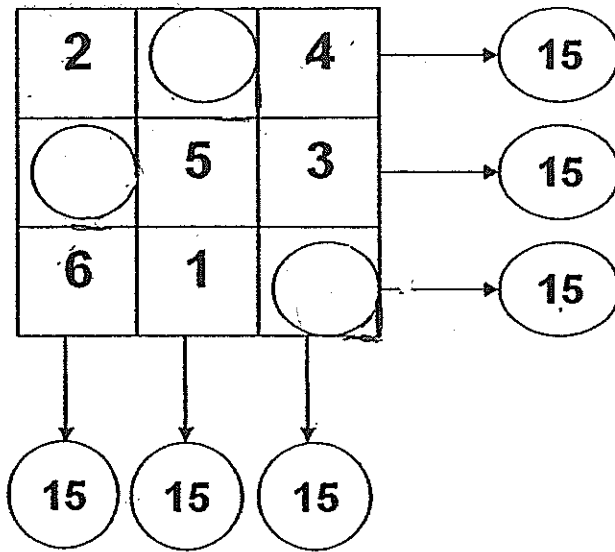

40. I think of two numbers.  
When I add them, I get 10:

$$\square + \square = 10$$

When I subtract them, I get 6.

$$\square - \square = 6$$

The two numbers are \_\_\_\_\_ and \_\_\_\_\_.

**Section B ( 20 marks )**

Questions 41 to 45 carry 4 marks each. Fill in the blanks and the statements carefully.

41. Ali folded 14 paper aeroplanes.  
He folded 5 paper aeroplanes less than Jamal.  
How many paper aeroplanes did Jamal fold?

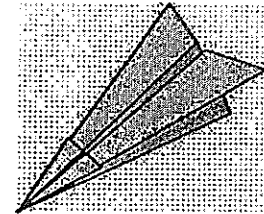

$$\square \bigcirc \square = \square$$

Jamal folded \_\_\_\_\_ paper aeroplanes.

42. Geeta and Weiming had 36 sweets altogether.  
Geeta had 24 sweets.  
How many sweets did Weiming have?



$$\square \bigcirc \square = \square$$

Weiming had \_\_\_\_\_ sweets.

43. Miss Lee gave all her erasers to 8 children.

Each child got 4 erasers.

How many erasers did Miss Lee have at first?

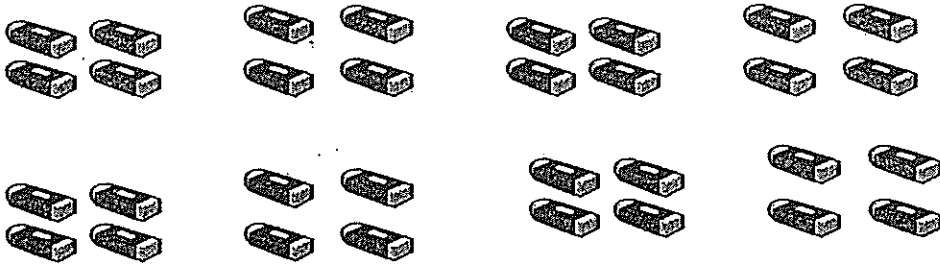

$$\square \bigcirc \square = \square$$

Miss Lee had \_\_\_\_\_ erasers at first.

44. Sumei has 21 matchsticks.

She uses 3 matchsticks to make each triangle.

She has made 2 triangles. Help Sumei to continue.

How many triangles can she make in all?

Draw the triangles in the box.

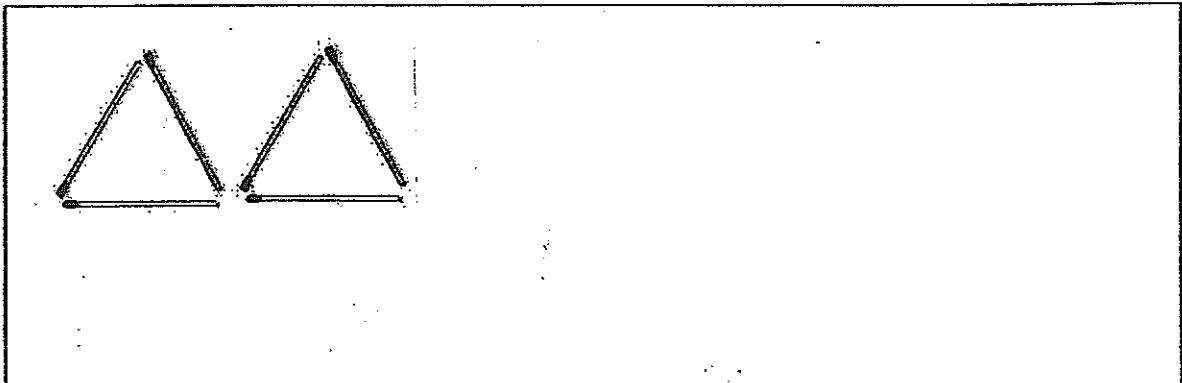

She can make \_\_\_\_\_ triangles in all.

45. Betty baked some cookies.

She sold 46 of them and packed the rest in 7 packets.

There were 4 cookies in each packet.

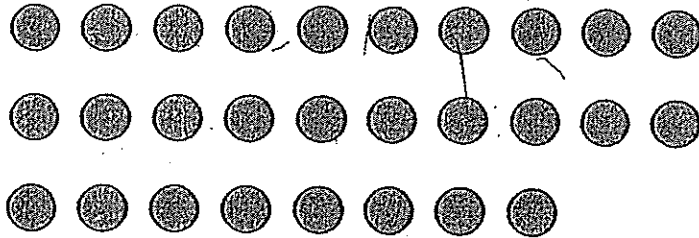

(a) How many cookies were not sold?

$$\square \circ \square = \square$$

\_\_\_\_\_ cookies were not sold.

(b) How many cookies did Betty bake in all?

$$\square \circ \square = \square$$

Betty baked \_\_\_\_\_ cookies in all.



Remember to check your work!  
Every mark counts.  
End of paper





# ANSWER SHEET

## EXAM PAPER 2010

SCHOOL : MAHA BODHI PRESBYTERIAN PRIMARY  
SUBJECT : PRIMARY 1 MATHEMATICS

TERM : SA2

1) eleven      2a) 17      2b) 5      3)  $10 + 8 + 3 = 21$

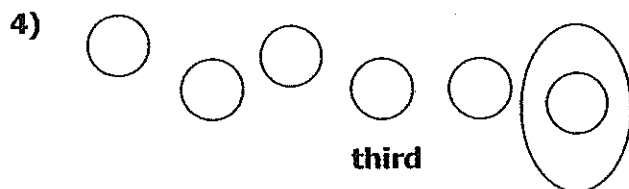

5) triangles

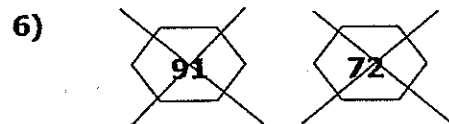

7) 59, 75, 81, 98

8) 80

9) 65

10)

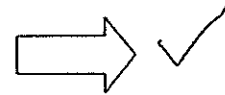

11) 13

12) 4, 8

13)

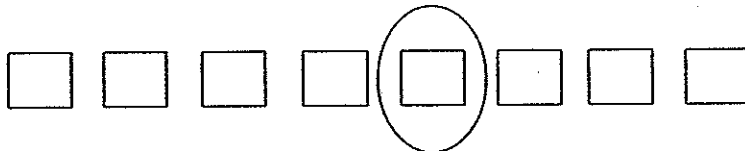

14) 28

15a) 17

15b) 21

16a) 45

16b) 90

17) -

18) 20

19) 3 \$10 notes and 2 \$1 coins

20)  $4 \times 3 = 12$

21)  $3 \times 4$  and  $6 \times 2$

22) 35

23) There are 4 fishes in each group.

24)

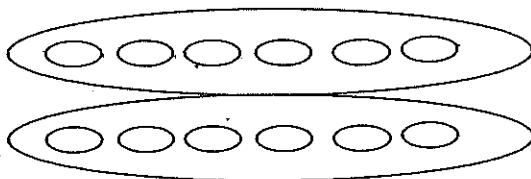

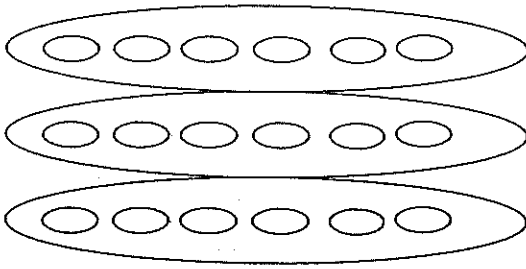

25) There are 3 apples on each tray.

26) half past 8

27) Gurmit, Amy

28) 11 and 7 → 18

29)



30)  $92 - 29 = 33$

31) 5

32) C

33) 3

34) 11

35) 3

36) B

37) 2

38) 3

39) 2, 9, 4 → 15

7, 5, 3 → 15

6, 1, 8 → 15

40)  $8 + 2 = 10$

$8 - 2 = 10$

The two numbers are 8 and 2.

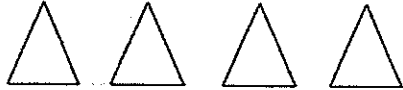
41) $14 + 5 = \underline{19}$	42) $36 - 24 = \underline{12}$
43) $4 \times 8 = 32$	44) Draw 4 more  She can make <u>7</u> triangles in all.
45a) $4 \times 7 = \underline{28}$ 45b) $28 + 46 = \underline{74}$	