

Maha Bodhi School
2004 Semestral Assessment 2
Mathematics

SA 2

Name : _____ ()

Class : Primary 3 ()

Date : 2 November 2004

Duration : 1h 45 min

Parent's

Signature _____

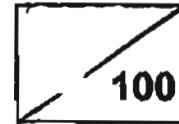

Section A – Multiple-Choice Questions (20)

For each question, four options are given. One of them is the correct answer. Make your choice (1, 2, 3 or 4) and shade the number in the corresponding oval on the OAS.

1. Which one of the following has the smallest value?

- (1) 298 ones
- (2) 75 tens
- (3) 3 hundreds
- (4) 2 thousands

2. $8329 = 8000 + 20 + \underline{\hspace{2cm}}$

- (1) 9
- (2) 300
- (3) 309
- (4) 3009

3. During recess, some boys played a game of musical chairs. At first, there were three rows A, B, and C with 8 boys in each row. Then 2 boys moved from A to B, 3 boys from B to C and 3 boys from C to A. How many boys are there in A now ?

- (1) 7
- (2) 8
- (3) 9
- (4) 10

4. What is the sum of the odd numbers between 72 and 80?

- (1) 152
- (2) 231
- (3) 304
- (4) 380

5. In 4857, the digit 8 is in the _____ place.

- (1) ones
- (2) tens
- (3) hundreds
- (4) thousands

6. In the diagram below, what would X probably be ?

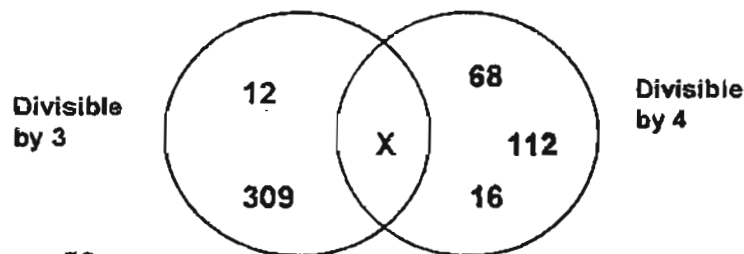

- (1) 52 ✓
- (2) 98 ✓
- (3) 105 ✓
- (4) 156

7. Write 305 cents in dollars and cents.

- (1) \$ 3.05
- (2) \$ 3.50
- (3) \$ 30.05
- (4) \$ 30.50

8. Judy has some 5-cent coins and some 10-cent coins in her pocket. She has 13 coins altogether. How much does she have?

- (1) \$ 0.65
- (2) \$ 1.10
- (3) \$ 1.30
- (4) \$ 1.35

9. $8020 \text{ m} = \underline{\hspace{1cm}} \text{ km } \underline{\hspace{1cm}} \text{ m}$

- (1) 8 km 2 m
- (2) 8 km 20 m
- (3) 80 km 20 m
- (4) 800 km 20 m

10. May bought a red streamer 3 m 70 cm long and a blue streamer 5 m 55 cm long to decorate the room for her party. What is the total length of the streamers?

- (1) 8 m 25 cm
- (2) 8 m 35 cm
- (3) 9 m 25 cm
- (4) 9 m 35 cm

11. 2 small tins of Milo weigh 780 g.
5 small tins of Milo weigh .

- (1) 1700 g
- (2) 1950 g
- (3) 2340 g
- (4) 3900 g

12. A honeydew weighs 1 kg 91 g. A watermelon weighs 3 kg 73 g. How much heavier is the watermelon?

- (1) 1 kg 62 g
- (2) 1 kg 82 g
- (3) 1 kg 962 g
- (4) 1 kg 982 g

13. Alex drinks 250 *ml* of milk daily. What is the total amount of milk he drinks in a week?

(1) 1 *l* 250 *ml*

(2) 1 *l* 500 *ml*

(3) 1 *l* 750 *ml*

(4) 1 *l* 900 *ml*

14. Yun Yun was carrying a pail which contained 2 *l* 270 *ml* of water to her classroom for the 'Use Your Hands Campaign'. She accidentally spilled 175 *ml* of water. How much water was left in the pail?

(1) 2 *l* 95 *ml*

(2) 2 *l* 195 *ml*

(3) 2 *l* 345 *ml*

(4) 2 *l* 445 *ml*

15. $\frac{3}{12}$ has the same value as _____.

(1) $\frac{1}{3}$

(2) $\frac{1}{4}$

(3) $\frac{2}{6}$

(4) $\frac{9}{24}$

16. Which one of the following figures shows $\frac{1}{3}$ of it shaded?

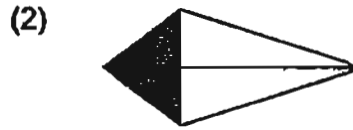

17. 28 minutes to 12 noon can be written as _____ .

- (1) 11.28 a.m.
- (2) 11.32 a.m.
- (3) 12.28 p.m.
- (4) 12.32 p.m.

18. The figure below is made up of 9 squares of sides 1 cm each. What is the area of the shaded part?

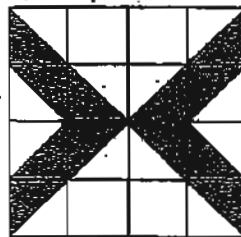

- (1) 12 cm²
- (2) 6 cm²
- (3) 3 cm²
- (4) 4 cm²

19. How many angles are there inside the figure?

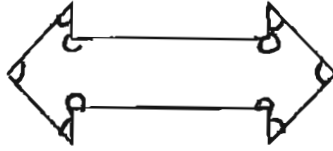

- (1) 6
- (2) 8
- (3) 10
- (4) 12

20. Arrange the following angles from the biggest to the smallest.

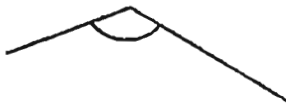

A



B



C

- (1) C, B, A
- (2) B, C, A
- (3) C, A, B
- (4) A, B, C

Section B – (20 x 2 marks)

Show your workings in the space provided. Marks will be awarded for correct method shown. Write your answers in the **BOXES** provided.

21. The number just before 7000 is _____

22. There were 1123 pupils in a school. 637 pupils were boys.
How many more boys than girls were there in the school?

23. Given below is a 3-digit number. For the number below to be divided by 7 equally, fill in the missing digit in the box .

5 8

24. \$0.75 = 2 twenty-cent coins and _____ five-cent coins.

25. Johnny paid for 3 cheeseburgers which cost \$1.40 each with a \$10 note.
How much would he get back?

26. Alex spent exactly \$5 on 3 different items in a café.
Of the items A, B, C or D, which three items did Alex buy?



\$2.40

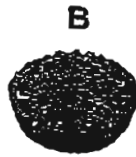

\$2.60



\$1.10



\$1.30

_____, _____ and _____

27. $5 \text{ l } 900 \text{ ml} + 2 \text{ l } 165 \text{ ml} = \text{_____ l } \text{_____ ml}$

_____ l _____ ml

28. The total cost of 3 egg tarts is the same as the total cost of 9 mini doughnuts. Instead of buying 24 egg tarts, how many mini doughnuts can I buy?

_____ mini doughnuts

The graph below shows Eric's examination results for 4 subjects.

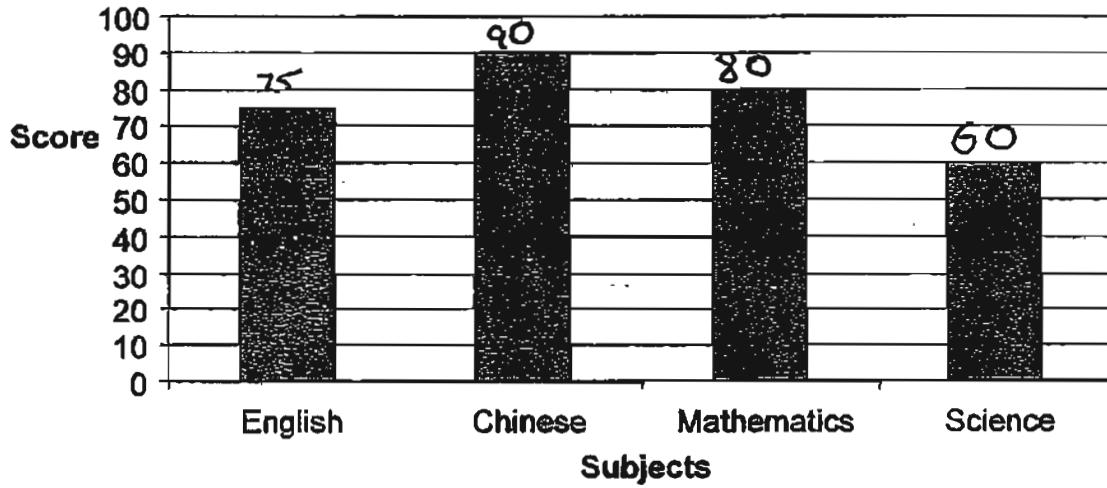

29. What was his score for Science?

marks

30. What was his total score for English and Mathematics?

marks

The graph below shows the number of cookies eaten by each child in a week.

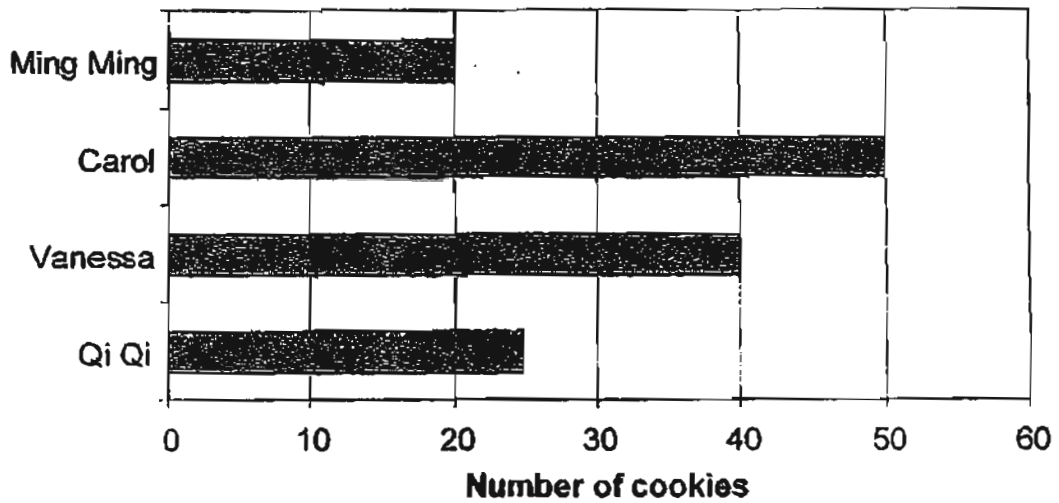

31. Who ate twice as many cookies as Qi Qi?

32. How many cookies did they eat altogether?

 cookies

33. Jason ate $\frac{3}{8}$ of a banana cake. Adrian ate $\frac{1}{8}$ of the same cake.

What fraction of the cake was eaten? (Give your answer in the simplest form.)

34. How many thirds are there in 4 wholes?

35. Arrange the fractions in order, beginning with the biggest.

$$\frac{1}{8}, \frac{5}{16}, \frac{1}{2}, \frac{1}{4}$$

36. There are _____ days in 7 weeks and 7 days.

37. A cashier works from 9.45 a.m. to 3 p.m. daily. If he works for 2 days, how many hours and minutes would that be?

38. What is the perimeter of the figure shown below?

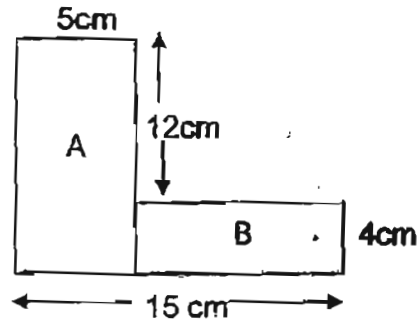

cm

39. The area of the shaded part of the square is 20 cm^2 .
What is the area of the whole square?

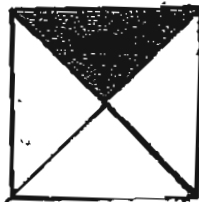

cm^2

40. The figure below is made up of squares of sides 2 cm each. What is the perimeter of the figure?

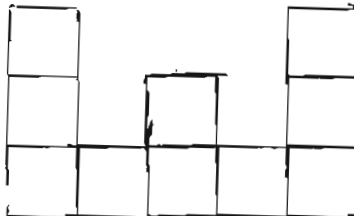

cm

Section C – (5 × 4 marks)

For questions 41 to 45, write your answers in the spaces provided.
For each question, show your working clearly in the space below each question.
Write a statement for each step.

41. Mr. Ho weighs 78 kg. His daughter weighs 52 kg less than him. His son weighs 12 kg more than his daughter. What is their total weight?

42. Mengli filled a water container with 9 litres of water. He poured out 3 glasses of water from it. Each glass held 120 *ml* of water. How much water was left in the container?

43. The area of a rectangular carpet is 40 m^2 . If the breadth of the carpet is 5 m, what is the perimeter of the carpet?

44. A teacher bought 6 tins of biscuits with 85 biscuits in each tin. She gave 8 biscuits to each of her student and had 46 biscuits left. How many students did the teacher have ?

-
45. Mrs Lee and Mrs Tan went shopping. They had a total of \$500. After each bought a \$75 handbag, Mrs Lee had 4 times as much money left as Mrs Tan. How much money had Mrs Tan left?



*Remember to check your work!
Every mark counts.*

--End of Paper --

MAHA BODHI SCHOOL
2004 SEMESTRAL ASSESSMENT 2
PRIMARY 3 MATHEMATICS

SAR

- 1) 1 28) 72
2) 3 29) 60
3) 3 30) 155
4) 3 31) Carol
5) 3 32) 135
6) 4 33) $\frac{1}{2}$
7) 1 34) 12
8) 2 35) $\frac{1}{2}$ $\frac{5}{16}$ $\frac{1}{4}$ $\frac{1}{8}$
9) 2 36) 56
10) 3 37) 10 hours 30 minutes
11) 2 38) 62
12) 4 39) 80
13) 3 40) 44
14) 1 41) 142 kg
15) 2 42) 8 litres 640 ml of water
16) 1 43) 26 m
17) 2 44) 58 students
18) 2 45) \$ 70
19) 3
20) 3
21) 6999
22) 151
23) 8
24) 7
25) ~~\$25.80~~ 5.80
26) B C D C D
27) 8 litres 65 ml

59
*END