

METHODIST GIRLS' SCHOOL

Founded in 1887



PRIMARY 4 MID-YEAR EXAMINATION 2010 MATHEMATICS BOOKLET A

Total Time: 1 h 45 minutes

INSTRUCTIONS TO CANDIDATES

Do not turn over this page until you are told to do so.
Follow all instructions carefully.
Answer all questions.

Name: _____ ()

Class: Primary 4 _____

Date: 6 May 2010

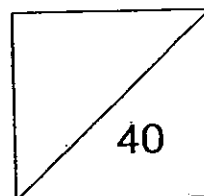

This booklet consists of 10 printed pages including this page.

Section A (40 marks)**Questions 1 to 20 carry 2 marks each.****For each of the following question, four options are given.****One of them is the correct answer.****Make your choice (1, 2, 3, 4). Shade the oval (1, 2, 3, 4) on the Optical Answer Sheet.**

1. Which of the following numbers when rounded off to the nearest ten is 24 100?
 - (1) 24 099
 - (2) 24 049
 - (3) 23 999
 - (4) 23 099

2. What is the lowest common multiple of 4 and 6?
 - (1) 10
 - (2) 2
 - (3) 12
 - (4) 24

3. What is the value of the digit 5 in 54 729?
 - (1) 5×10
 - (2) 50×10
 - (3) 500×10
 - (4) 5000×10

Go on to the next page

4. What is the difference between the greatest and the smallest factor of 50?

- (1) 25
- (2) 49
- (3) 51
- (4) 150

5. The line graph below shows the number of movie tickets sold from Thursday to Sunday.

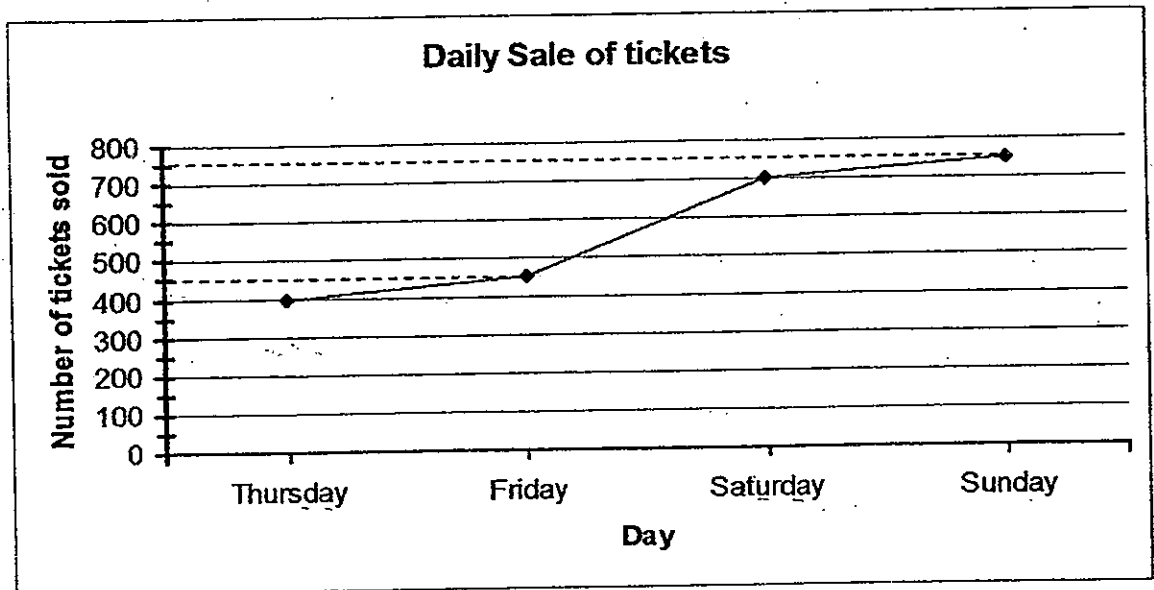

How many more tickets were sold on Saturday than on Friday?

- (1) 250
- (2) 450
- (3) 700
- (4) 1150

Go on to the next page

6. Mrs Lam baked 242 chicken wings and packed them into boxes for a party. Each box can hold a maximum of 7 chicken wings. What was the minimum number of boxes she used?
- (1) 34
 - (2) 35
 - (3) 38
 - (4) 41
7. Which one of the following gives the best estimate for 593×87 ?
- (1) 500×80
 - (2) 500×90
 - (3) 600×80
 - (4) 600×90
8. Find the product of 60 ones and 6 tens.
- (1) 120
 - (2) 360
 - (3) 606
 - (4) 3 600

The graph below shows the amount of rainfall recorded from January to June. Study the graph carefully and answer questions 9 and 10.

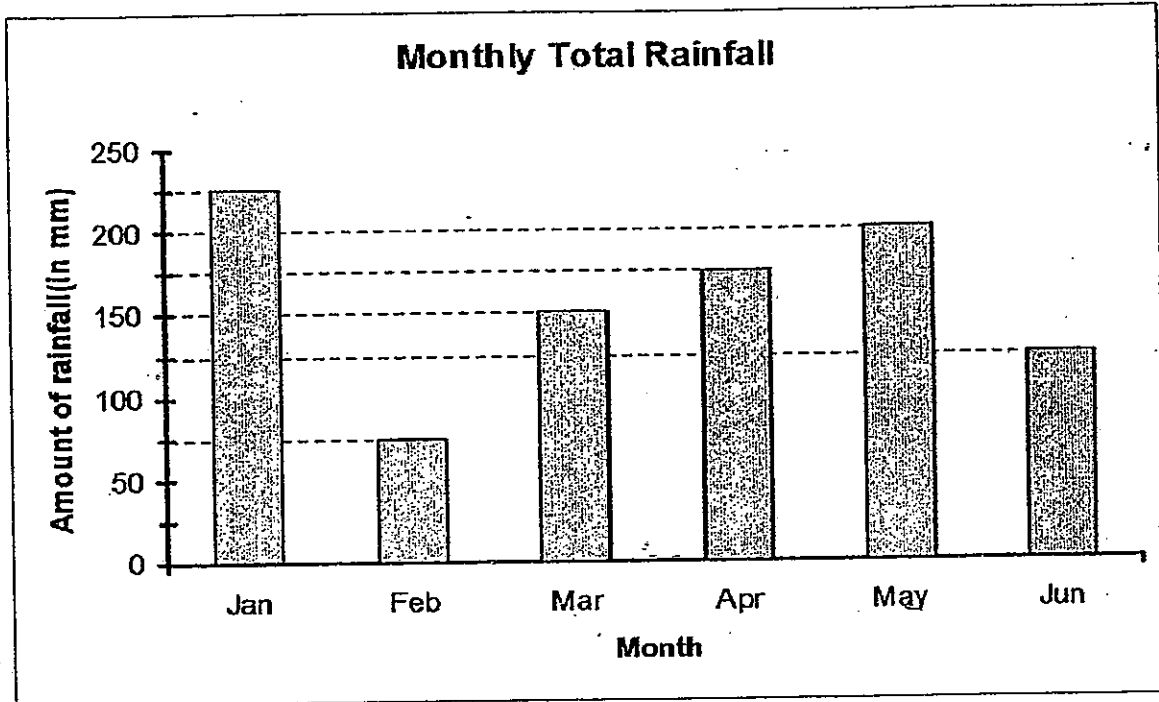

9. Which of the following shows the same increase in rainfall as from Mar to Apr?
- (1) Jan to Feb
- (2) Feb to Mar
- (3) May to Jun
- (4) Apr to May
10. What is the difference in the amount of rainfall between the month with the highest amount of rainfall and the month with the lowest amount of rainfall?
- (1) 75 mm
- (2) 150 mm
- (3) 350 mm
- (4) 375 mm

Go on to the next page

11. $\frac{5}{6} + \frac{5}{6} + \frac{5}{6} + \frac{5}{6}$ is the same as _____.

(1) $\frac{20}{24}$

(2) $3\frac{1}{2}$

(3) $3\frac{1}{3}$

(4) $4\frac{5}{6}$

12. How many sixths are there in $2\frac{2}{3}$?

(1) 12

(2) 2

(3) 16

(4) 4

13. $\frac{2}{9} + \frac{\square}{18} = \frac{2}{3}$

What is the number in the missing box?

(1) 9

(2) 2

(3) 8

(4) 4

Go on to the next page

14. There are 40 rabbits and cats altogether in a pet shop.

If $\frac{3}{5}$ of them are cats, how many rabbits are there?

- (1) 8
- (2) 16
- (3) 24
- (4) 32

15. Dave spent $\frac{2}{9}$ of his money on a canvas bag and $\frac{1}{3}$ of it on a pair of spectacles.

What fraction of his money did he save?

- (1) $\frac{1}{3}$
- (2) $\frac{2}{3}$
- (3) $\frac{4}{9}$
- (4) $\frac{5}{9}$

16. How many right angles are there in $1\frac{3}{4}$ turns?

- (1) 6
- (2) 5
- (3) 3
- (4) 7

17. The figure below is not drawn to scale.
 A piece of wire, 42 cm long, is bent to form the shape below.
 ABCD is a square and the length of AB is 6 cm.
 Find the length of DE.

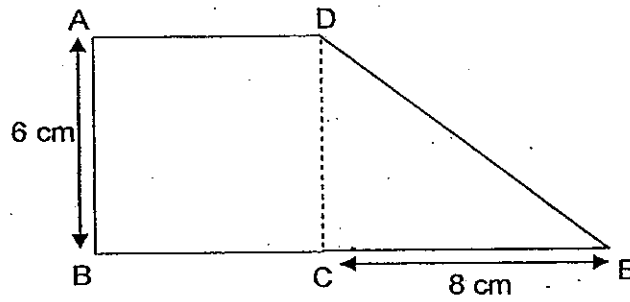

- (1) 6 cm
 (2) 8 cm
 (3) 10 cm
 (4) 16 cm
18. Which one of the following lines is parallel to XY?

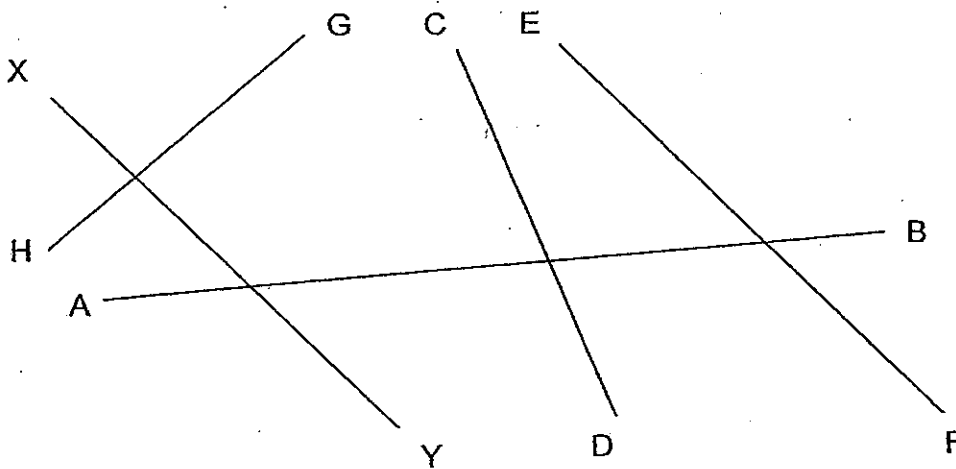

- (1) AB
 (2) CD
 (3) EF
 (4) GH

19. Kai Wen is standing on the spot marked X, facing the post office.
He makes a 135° turn in a clockwise direction and then a $\frac{1}{4}$ -turn in an anti-clockwise direction.
Where will Kai Wen be facing now?

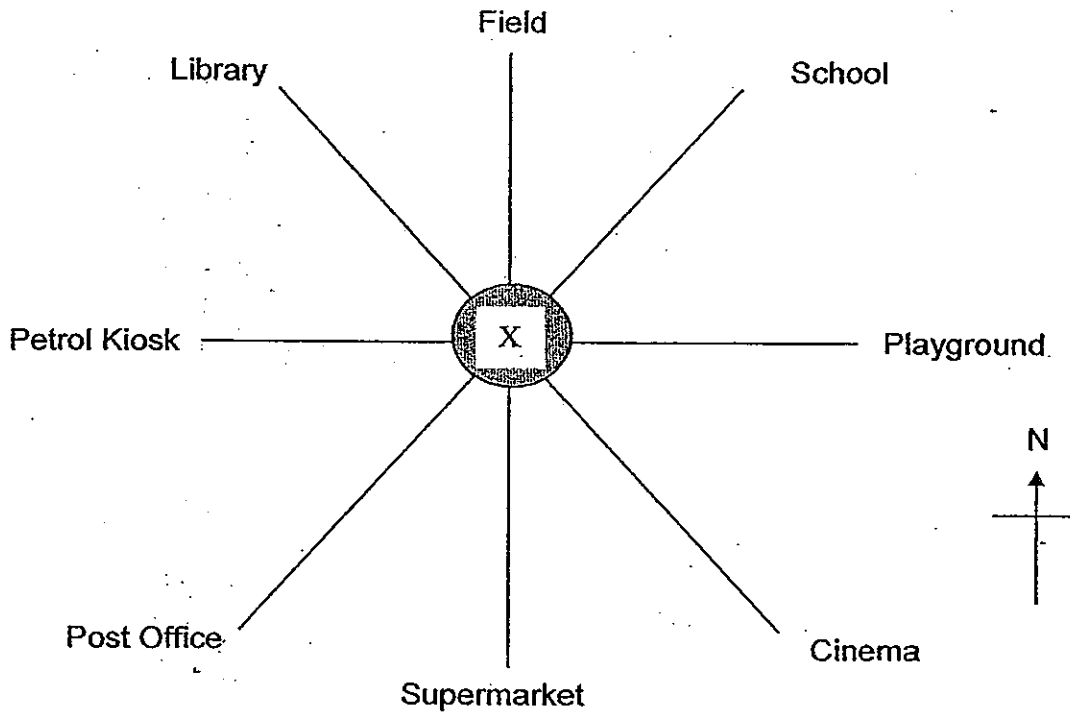

- (1) School
- (2) Library
- (3) Supermarket
- (4) Petrol Kiosk

Go on to the next page

20. I am a four-sided figure.
I have two pairs of parallel lines and I do not have right angles.
Which one of the following figures am I?

(1)

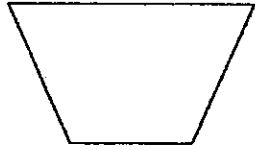

(2)



(3)

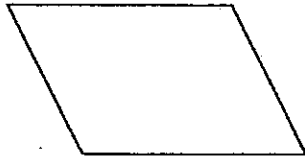

(4)

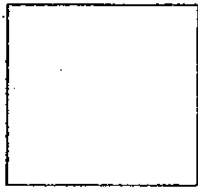

METHODIST GIRLS' SCHOOL

Founded in 1887



PRIMARY 4 MID-YEAR EXAMINATION 2010 MATHEMATICS BOOKLET B

Total Time: 1 h 45 minutes

INSTRUCTIONS TO CANDIDATES

Do not turn over this page until you are told to do so.
Follow all instructions carefully.
Answer all questions.

Name: _____ ()

Class: Primary 4. _____

Date: 6 May 2010

Booklet A	40
Booklet B	60
Total	100

14

This booklet consists of ~~13~~ printed pages including this page.

Section B (40 marks)

Questions 21 to 40 carry 2 marks each.

Write your answers in the space provided.

For questions which require units, give your answers in the units stated.

Study the table carefully and answer questions 21 and 22.

The table below shows the number of books borrowed by pupils in Primary 4B from the school library.

Number of books borrowed	Number of children
0	6
1	7
2	10
3	5
4	8

21. How many children were there altogether?

children

22. How many books did the children borrow?

books

Go on to the next page

23. What is the missing number in the number pattern below?

49, 36, _____, 16, 9, 4

24. Write 30 049 in words.

25. Using the digits 7, 0, 3, 4 and 8, form the smallest 5-digit **odd** number.

26. 'X' is a whole number between 20 and 30. It is also a multiple of 7. The sum of all its factors is 56. What is 'X'?

Go on to the next page

Study the table carefully and answer questions 27 and 28.

The table below shows the number of chicken sandwiches and hotdog buns sold in a school canteen in a week.

Day	Chicken sandwiches \$1 each	Hotdog buns \$1 each
Monday	25	30
Tuesday	30	22
Wednesday	75	100
Thursday	40	48
Friday	30	?

27. The total amount of money collected from the sale of both chicken sandwiches and hotdog buns for that week was \$500. How many hotdog buns were sold on Friday?

28. What is the difference in the total amount collected from the sale of chicken sandwiches and hotdog buns on Wednesday and the amount collected from the same two items on Thursday?

Go on to the next page

29. AB, CE and DE are straight lines.
Name two angles that are more than 90° but less than 180° .

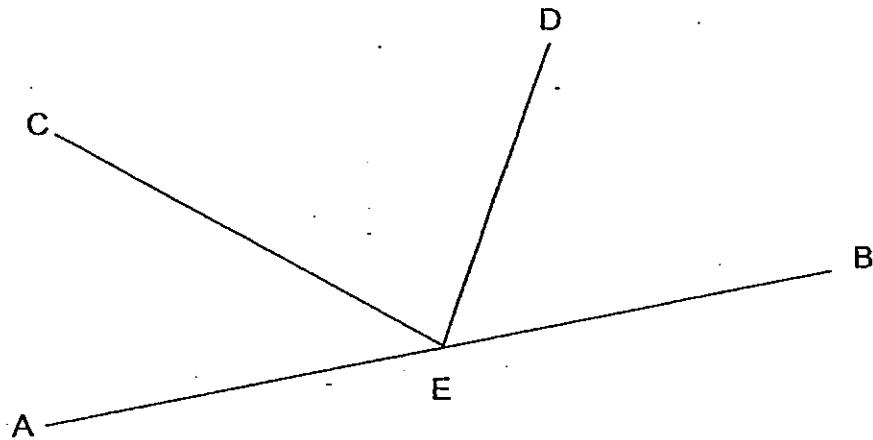

and

30. Ben and Dave have a total of 420 stickers.
Dave has $\frac{1}{6}$ as many stickers as Ben.
How many stickers does Ben have?

Go on to the next page

31. What is the value of $2\frac{1}{4} - \frac{3}{8}$?

Express your answer as an improper fraction.

32. Mrs Devi has a bale of cloth measuring 96 m.

She used $\frac{1}{3}$ of the cloth on Saturday and $\frac{1}{4}$ of the same cloth on Sunday.

How much cloth did she use on both days?

 m

33. In the number line below, what is the value of X?
Express your answer as a mixed number in its simplest form.

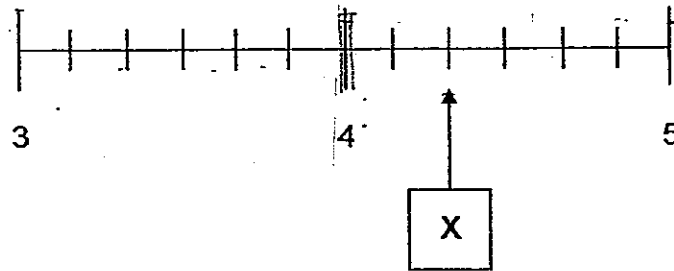

34. A fish tank can hold 12 litres of water.

$\frac{5}{6}$ of the tank is filled with water.

How much water is needed to fill the tank completely?

Go on to the next page

35. Join point Y to one of the three crosses, A, B or C, to form an angle of 65° .
Mark the angle and label it.

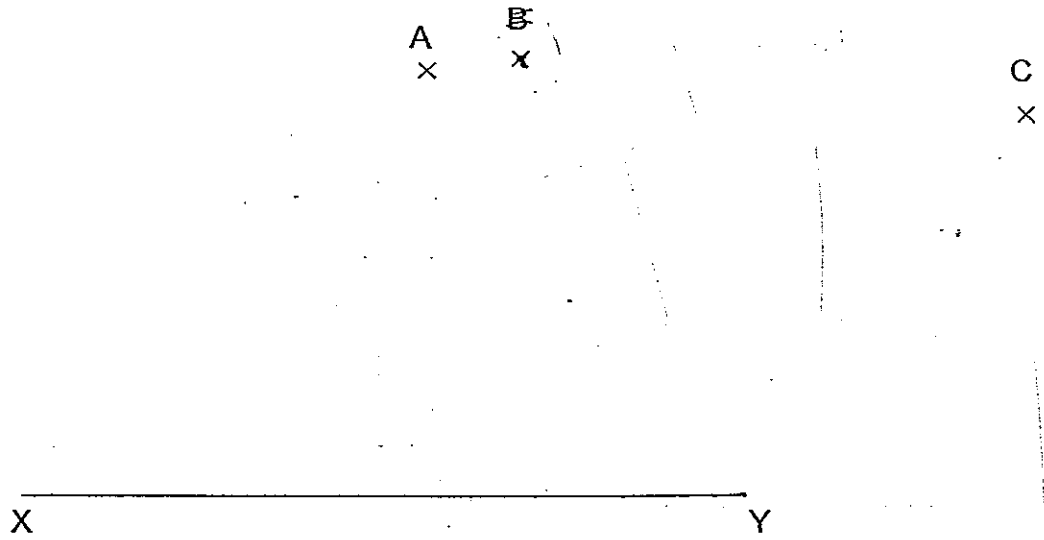

36. WXYZ is a square.
Find $\angle m$.

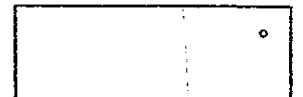
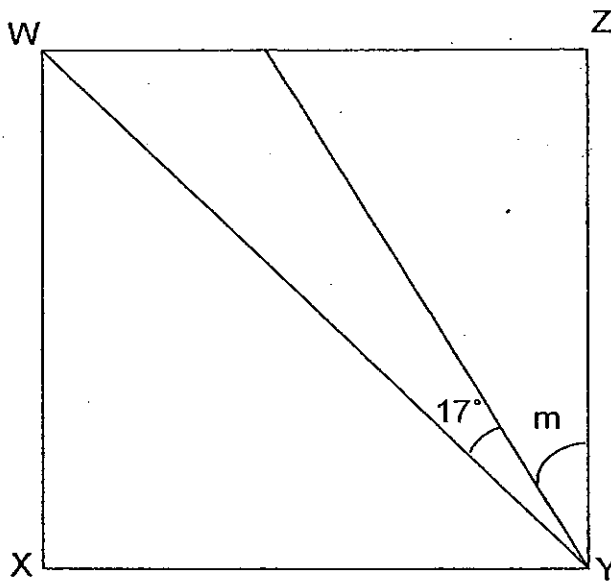

Go on to the next page

37. The figure below is not drawn to scale.
 All lines in the figure below meet at right angles.
 Find the following:
- the length of AB
 - the length of HC

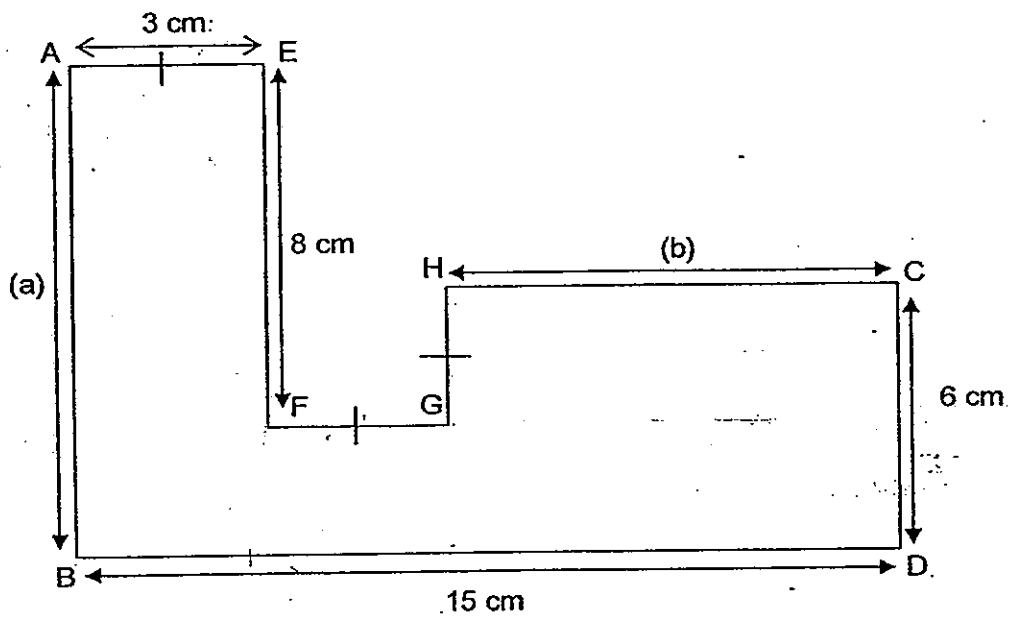

(a) $AB = \quad \text{cm}$ [2]

(b) $HC = \quad \text{cm}$ [2]

Go on to the next page

38. Using a set square and a ruler, draw a line that is perpendicular to AB, passing through point C.

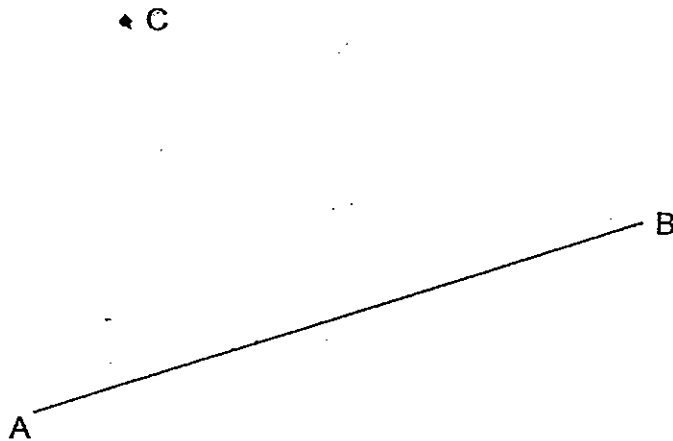

39. UVWX is a 4-sided figure.
Name and measure the marked angle in the figure.

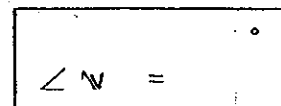
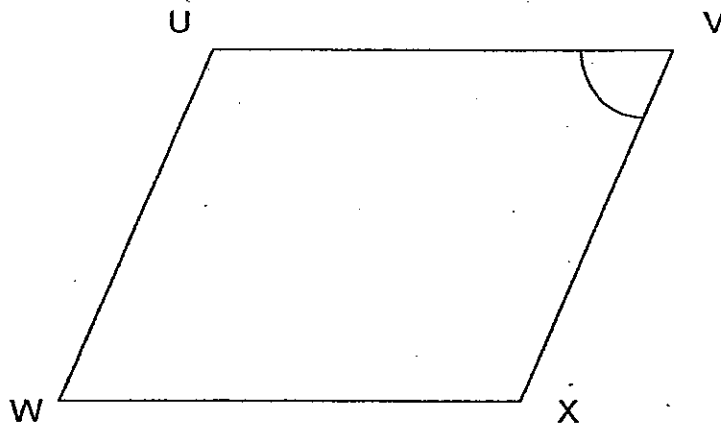

Go on to the next page

40. How many right angles are there in the letter 'Z' below?

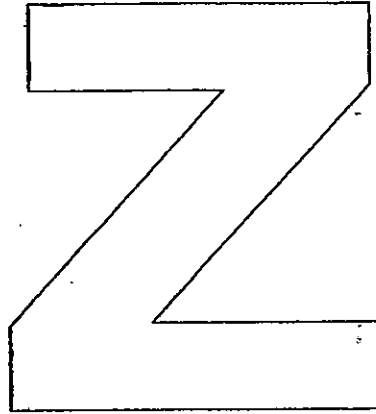

Section C (20 marks)**Questions 41 to 45 carry 4 marks each.****Show your working clearly in the space provided for each question and write your answers in the space provided.****The number of marks available is shown in brackets [] at the end of each question or part-question.**

41. Peggy had 24 packets of sweets.

There were 18 sweets in each packet.

She sold 79 sweets on Monday and 65 sweets on Tuesday.

She then packed the remaining sweets equally into 6 bags.

How many sweets are there in each bag?

Ans: _____ [4]

42. Mr Tan had a total of 315 pears and apples.

He sold half of the pears and 78 apples.

In the end, he had an equal number of pears and apples left.

How many apples did Mr Tan have at first?

Ans: _____ [4]

Go on to the next page

43. Levon had \$20 more than Brandon.

After Levon spent \$56 and Brandon spent \$72, Levon had 4 times as much money as Brandon.

How much money did Levon have at first?

Ans: _____ [4]

44. Mrs Johnson gave some money to her three children.

Jason received $\frac{1}{4}$ of the money, Joel received $\frac{1}{8}$ of the money and Jean received \$300.

How much more money did Jean receive than Joel?

Ans: _____ [4]

Go on to the next page

45. The number of girls in the playground was $\frac{5}{7}$ of the number of boys.

There were 16 more boys than girls.

After some boys had gone home, the number of girls became twice the number of boys.

- (a) How many children were in the playground at first?
- (b) How many boys went home?

Ans: (a) _____ [2]

(b) _____ [2]

END OF PAPER

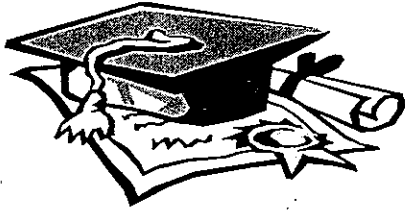

ANSWER SHEET

EXAM PAPER 2010

SCHOOL : METHODIST GIRLS' SCHOOL PRIMARY
SUBJECT : PRIMARY 4 MATHEMATICS

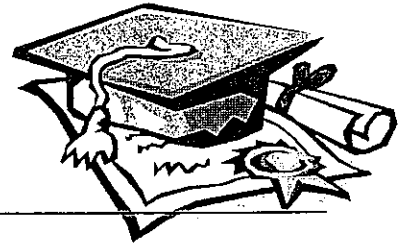

TERM : SA1

Q1	Q2	Q3	Q4	Q5	Q6	Q7	Q8	Q9	Q10	Q11	Q12	Q13	Q14	Q15	Q16	Q17
1	3	4	2	1	2	4	4	4	2	3	3	3	2	3	4	4

Q18	Q19	Q20
3	4	3

21) 36 students
forty-nine

22) 74 books

23) 25

24) thirty thousand and

25) 30487
and Angle BEC

26) X is 28

27) 100 hotdog buns

28) \$87

29) Angle CEB

30) 360 stickers

31) $15/8$

32) 56m

33) $4 \frac{1}{3}$

34) 2?

35)

36) 28°

37) a) 11cm b) 9cm

38)

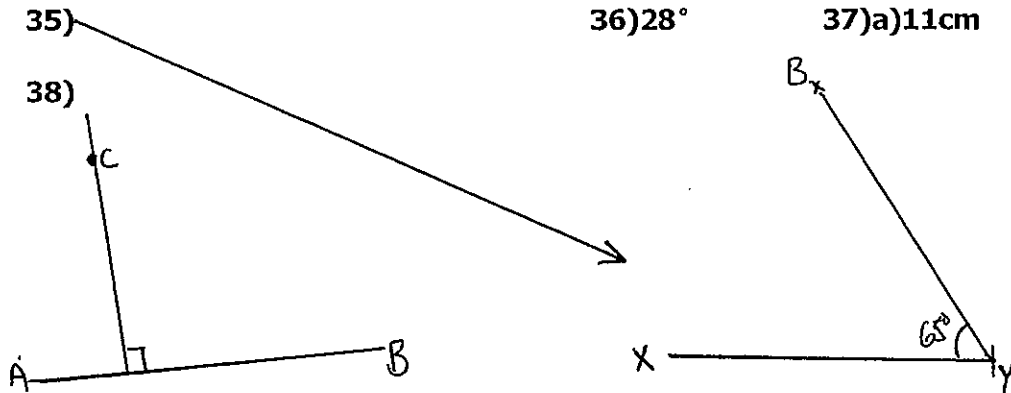

39) angle UVX = 67°

40) 6 right angles

Section C

<p>41)</p> <p>$24 \times 18 = 432$ $79 + 65 = 144$ $432 - 144 = 288$ $288 \div 6 = 48$ There are 48 sweets in each bag.</p>	<p>42)</p> <p>$315 - 78 = 237$ 3 units – 237 1 unit – 79 $79 + 78 = 157$ Mr Tan had 157 apples at first.</p>
<p>43)</p> <p>$56 - 20 = 36$ $72 - 36 = 36$ $36 \div 3 = 12$ $12 \times 4 = 48$ $48 + 56 = 104$ Levon had \$104 at first.</p>	<p>44)</p> <p>1 unit – Joël $300 \div 5 = 60$ $300 - 60 = 240$ Jean received \$240 more than Jason.</p>
<p>45a)</p> <p>2 units – 16 1 unit – $16 \div 2 = 8$ $8 \times 12 = 96$ There were 96 children at first.</p>	<p>45b)</p> <p>$8 \div 2 = 4$ $9 \times 4 = 36$ 36 boys left the playground.</p>