

15

SINGAPORE CHINESE GIRLS' SCHOOL

FIRST SEMESTRAL ASSESSMENT 2016

PRIMARY 4

MATHEMATICS

BOOKLET A

Name : _____ ()

Parent's Signature

Class : Primary 4

There are 15 questions in this booklet.
SECTION A

Total Time : 1 h 45 min (Booklet A and B)

INSTRUCTIONS TO CANDIDATES

DO NOT OPEN THIS BOOKLET UNTIL YOU ARE TOLD TO DO SO.
FOLLOW ALL INSTRUCTIONS CAREFULLY.
ANSWER ALL QUESTIONS.
CHECK THAT ALL MCQ ANSWERS ARE SHADED CORRECTLY IN THE OAS

This question paper consists of 6 printed pages. (Inclusive of cover page)

Section A: (30 marks)

Questions 1 to 15 carry 2 marks each. For each question, four options are given. One of them is the correct answer. Make your choice (1, 2, 3 or 4). Shade the correct oval (1, 2, 3 or 4) on the Optical Answer Sheet.

1. What is the value of the digit 8 in 46 891?

- (1) 8
- (2) 80
- (3) 800
- (4) 8000

2. Round off 56 499 to the nearest hundred.

- (1) 56 000
- (2) 56 400
- (3) 56 490
- (4) 56 500

3. Which of the following is **not** a common factor of 12 and 18?

- (1) 6
- (2) 2
- (3) 3
- (4) 4

4. The figure below is not drawn to scale. ABC is a straight line. Estimate the value of y .

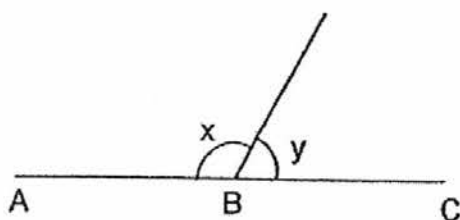

- (1) 10°
- (2) 75°
- (3) 90°
- (4) 130°

5. How many angles inside the figure shown below are greater than a right angle?

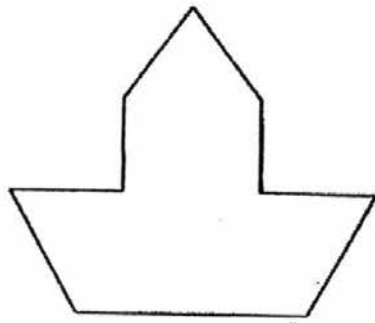

- (1) 9
- (2) 6
- (3) 3
- (4) 4

6. T H E O R Y

How many of the letter(s) above has/have both perpendicular and parallel lines?

- (1) 1
- (2) 2
- (3) 3
- (4) 4

7. Which one of the letters has no lines of symmetry?

F

(1)

O

(2)

X

(3)

Y

(4)

8. Find the common multiple of 4 and 6.

(1) 12

(2) 2

(3) 18

(4) 4

9. There are 12 adults and 16 children at a party. What fraction of the people at the party were children?

(1) $\frac{1}{4}$

(2) $\frac{3}{4}$

(3) $\frac{3}{7}$

(4) $\frac{4}{7}$

10. Mrs Lee bought 4 kg of longans. She ate $\frac{5}{8}$ kg of longans. How much longans had she left?

(1) $3\frac{3}{8}$ kg

(2) $3\frac{5}{8}$ kg

(3) $4\frac{3}{8}$ kg

(4) $4\frac{5}{8}$ kg

11. Arrange the following in decreasing order.

(1) $2, \frac{6}{5}, \frac{2}{3}, \frac{2}{5}$

(2) $2, \frac{6}{5}, \frac{2}{5}, \frac{2}{3}$

(3) $2, \frac{2}{3}, \frac{6}{5}, \frac{2}{5}$

(4) $2, \frac{2}{3}, \frac{2}{5}, \frac{6}{5}$

12. Look at the 8-point compass below.

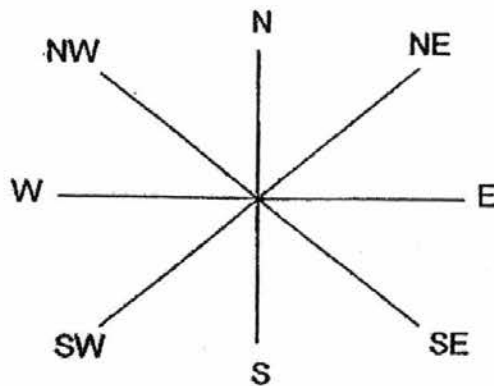

When Siti turns 135° in an anti-clockwise direction, she will face East.
Where was she facing at first?

- (1) W
- (2) S
- (3) NW
- (4) SW

13. ABCD is a rectangle and DEFG is a square. Find angle BDF.

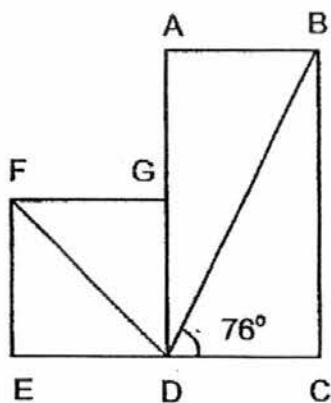

- (1) 14°
(2) 59°
(3) 90°
(4) 121°
14. The sum of 2 numbers is equal to the product of 24 and 5. If one of the numbers is 75, what is the other number?
- (1) 25
(2) 45
(3) 175
(4) 195
15. Mrs Lee poured $\frac{2}{3}$ litres of water into beaker A. She poured $\frac{1}{6}$ litres less water into beaker B. How much water was there in both beakers A and B?

- (1) $\frac{1}{2}$ litres
(2) $\frac{5}{6}$ litres
(3) $1\frac{1}{6}$ litres
(4) $1\frac{1}{2}$ litres

END OF BOOKLET A

SINGAPORE CHINESE GIRLS' SCHOOL

FIRST SEMESTRAL ASSESSMENT 2016

PRIMARY 4

MATHEMATICS

BOOKLET B

Name : _____ ()

Class : Primary 4

		Marks attained	Max Mark
Booklet A	Section A		30
Booklet B	Section B		40
	Section C		30
Total			100

Parent's Signature

There are 28 questions in this booklet,
SECTION B and C

Total Time : 1 h 45 min (Booklet A and B)

INSTRUCTIONS TO CANDIDATES

DO NOT OPEN THIS BOOKLET UNTIL YOU ARE TOLD TO DO SO.
FOLLOW ALL INSTRUCTIONS CAREFULLY.
ANSWER ALL QUESTIONS.

This question paper consists of 16 printed pages. (Inclusive of cover page)

19. Here are five number cards.

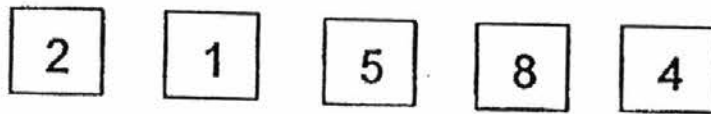

Arrange these cards to form the greatest 5-digit even number.

Ans : _____

Do not write
in this column

20. Look at the number line below. Write the fraction or mixed number in the boxes provided.

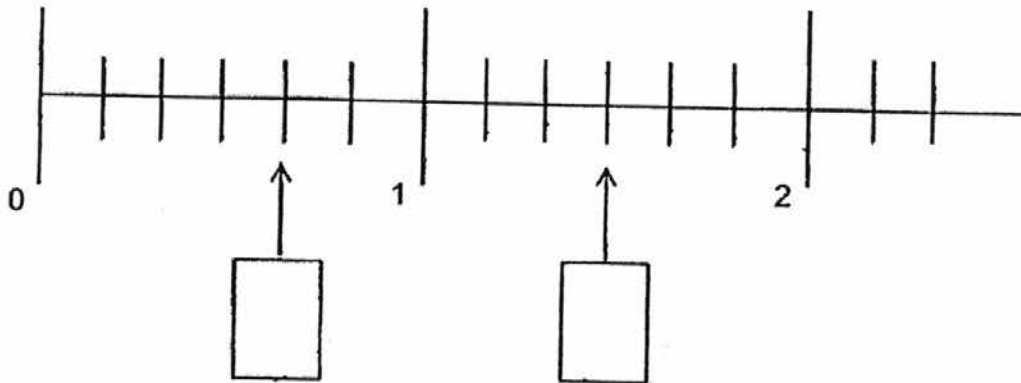

21. $37 \times 48 =$ _____

Ans : _____

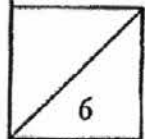

22. $\frac{1}{10} + \frac{4}{5} = \square$

Do not write
in this column

Ans : _____

23. Draw a line perpendicular to EF passing through point P.

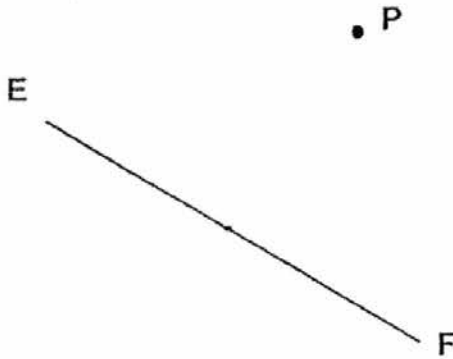

24. Construct and label an angle such that $\angle ABC$ is equal to 55° .

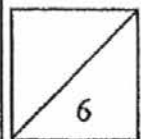

Do not write
in this column

25. Mother packed 385 cookies equally into 4 boxes. How many cookies were left over?

Ans : _____

26. $\frac{1}{4}$ of Huiling's stamps is 12. How many stamps does she have?

Ans : _____

27. Four circles are shaded below. How many more circles should be shaded so that $\frac{4}{9}$ of the set is shaded?

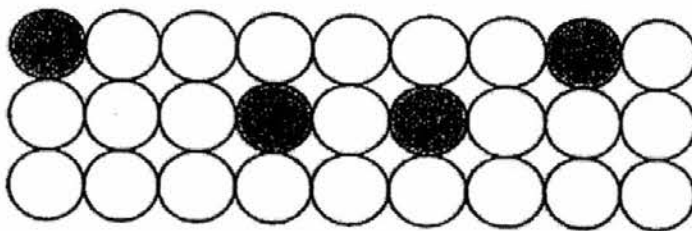

Ans : _____

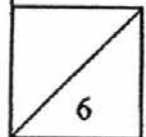

28. Devi had 100g of sugar. She used $\frac{2}{5}$ of the sugar. How much sugar was left?

Do not write
in this column

Ans : _____ g

29. In the figure below, ABC is a straight line. Find $\angle m$.

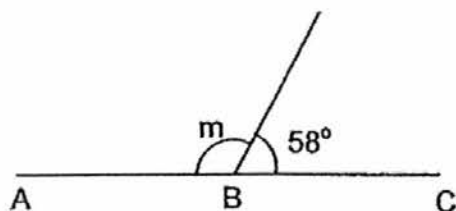

Ans : _____ $^\circ$

30. PQRS is a rectangle. Find the value of $\angle w$.

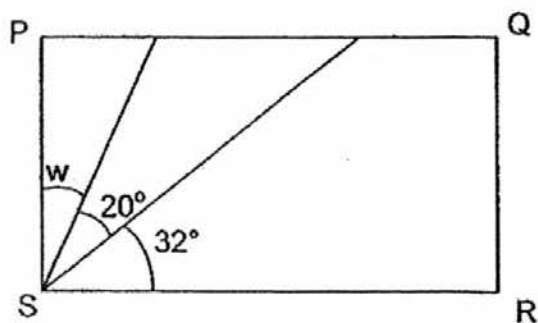

Ans : _____ $^\circ$

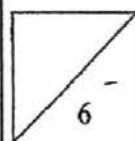

31. Shade and complete the figure using the bold line as the line of symmetry.

Do not write
in this column

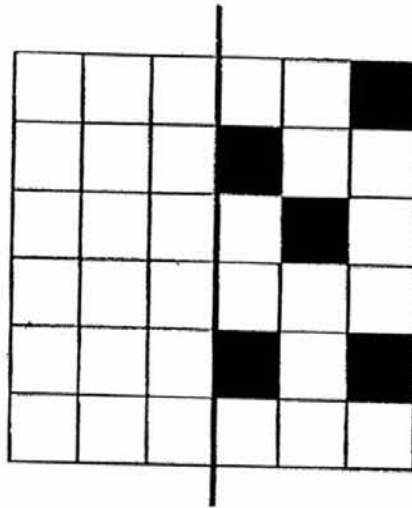

32. There are some pupils in the hall. $\frac{4}{9}$ of the pupils are boys and the rest are girls. There are 40 girls. How many pupils are there in the hall?

Ans : _____

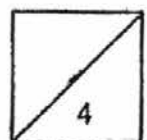

33. A string was 4m long. Christina gave $\frac{1}{4}$ of it to her sister and $\frac{3}{4}$ m to her friends. How much string had she given away?

Do not write
in this column

Ans: _____ m

-
34. A bag and a pair of shoes cost \$200. The bag cost 4 times as much as a pair of shoes. Find the cost of a pair of shoes.

Ans : \$ _____

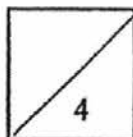

35. Fiona, Gillian and Heather had a total of 275 stickers. Fiona had thrice as many stickers as Gillian and Heather had 30 more stickers than Gillian. How many stickers did Gillian have?

Do not write
in this column

Ans : _____

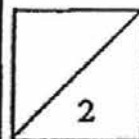

Section C: (30 marks)

For questions 36 to 43, show your working clearly in the space provided for each question and write your answer in the space provided. The number of marks available is shown in brackets [] at the end of each question or part-question.

Do not write
in this column

36. The figure below is made up of 3 identical rectangles. Find the lengths of
a) CD,
b) AF.

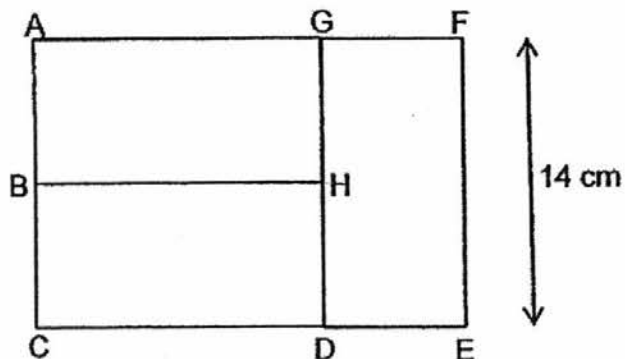

Ans: a) _____ [1]

b) _____ [2]

37. Kelly won \$888 in a lucky draw. She donated \$350 to charity and divided the rest equally among her 2 children. How much money did each child get?

Ans: _____ [3]

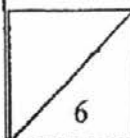

38. Sandy bought 15 boxes of erasers. There were 14 erasers in each box. She repacked the erasers into packets of 8 erasers each.
- a) How many packets would there be?
 - b) How many erasers were left over?

Do not write
in this column

Ans: a) _____ [3]

b) _____ [1]

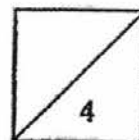

39. A bottle of milk was $\frac{1}{2}$ full. After Linda drank 120 ml of milk from the bottle, it became $\frac{5}{12}$ full. How much milk was there in the bottle when it was $\frac{1}{2}$ full?

Do not write
in this column

Ans: _____ [4]

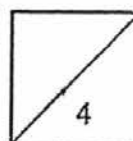

40. There were 250 more English books than Chinese books in a school library. When the librarian bought another 120 English books and 80 Chinese books, the total number of books in the library became 1500. How many English books were there at first?

Do not write
in this column

Ans: _____ [4]

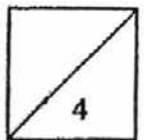

41. At a buffet, $\frac{1}{8}$ of the sticks of satay were beef, $\frac{1}{4}$ of them were mutton and the rest were chicken. Given that there were 225 sticks of chicken satay, how many sticks of satay were there at the buffet?

Do not write
in this column

Ans: _____ [4]

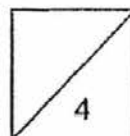

42. Emma has 180 erasers. She has 5 times as many erasers as Janice.
a) How many erasers must Emma give Janice so that they will have the same number of erasers?
b) How many erasers do they have altogether?

Do not write
in this column

Ans: a) _____ [2]

b) _____ [2]

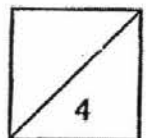

43. Ruth had 36 more sweets than Kayla at first. After Kayla had eaten 15 of her sweets, Ruth had four times as many sweets as Kayla.
How many sweets did Ruth and Kayla have in total at first?

Do not write
in this column

Ans: _____ [4]

**END OF PAPER
PLEASE CHECK YOUR WORK**

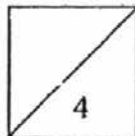

EXAM PAPER 2016 (P4)

SCHOOL : SCGS

SUBJECT : MATHEMATICS

TERM : SA1

Q1	Q2	Q3	Q4	Q5	Q6	Q7	Q8	Q9	Q10
3	4	4	2	2	2	1	1	4	1
Q11	Q12	Q13	Q14	Q15					
1	4	2	2	3					

19. Here are five number cards.

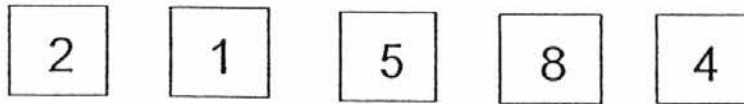

Arrange these cards to form the greatest 5-digit **even** number.

Ans: 85412

20. Look at the number line below. Write the fraction or mixed number in the boxes provided.

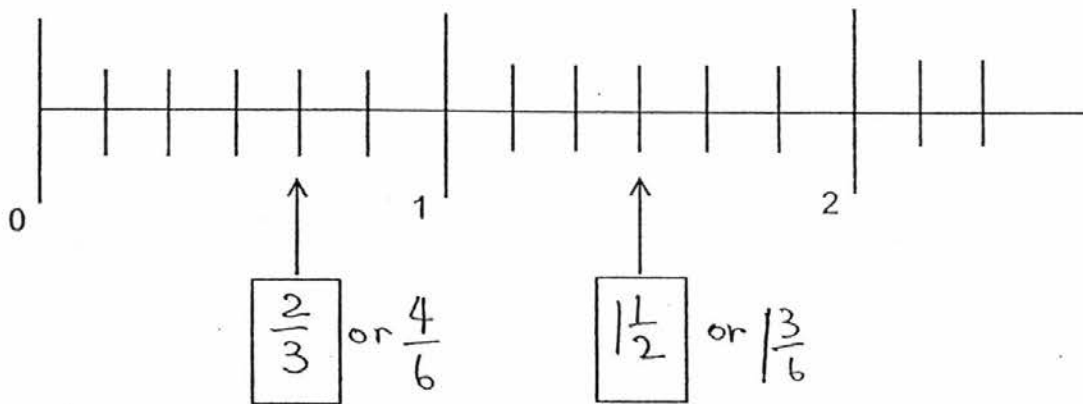

21. $37 \times 48 =$ _____

$$\begin{array}{r}
 \begin{array}{r}
 52 \\
 37 \\
 \times 48 \\
 \hline
 296 \\
 1480 \\
 \hline
 1776
 \end{array}
 \end{array}$$

Ans: 1776

Do not write
in this column

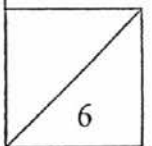

22. $\frac{1}{10} + \frac{4}{5} = \square$

$\frac{1}{10} + \frac{8}{10} = \frac{9}{10}$

Ans: $\frac{9}{10}$

Do not write
in this column

23. Draw a line perpendicular to EF passing through point P.

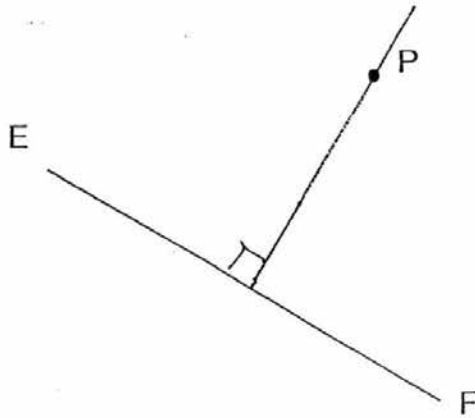

24. Construct and label an angle such that ABC is equal to 55°.

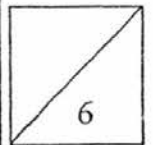
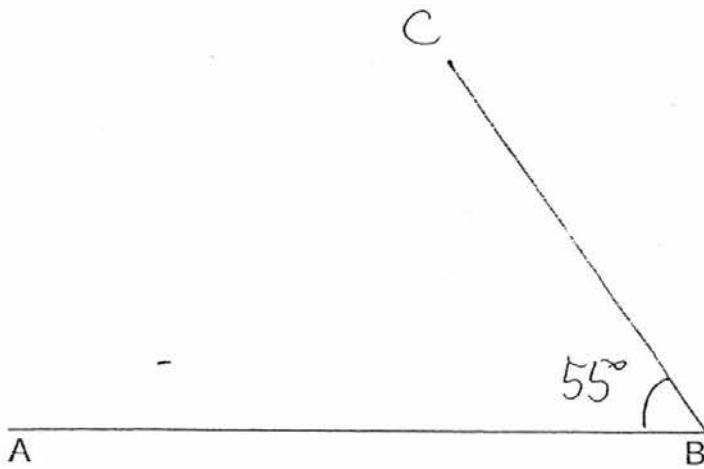

Do not write
In this column

25. Mother packed 385 cookies equally into 4 boxes. How many cookies were left over?

$$\begin{array}{r} 96 \text{ R } 1 \\ 4 \overline{) 385} \\ \underline{-36} \\ 25 \\ \underline{-24} \\ 1 \end{array}$$

Ans : 1

26. $\frac{1}{4}$ of Huiling's stamps is 12. How many stamps does she have?

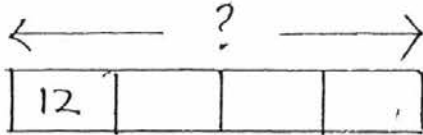

$$\begin{aligned} 1u &= 12 \\ 4u &= 12 \times 4 \\ &= 48 \end{aligned}$$

Ans : 48

27. Four circles are shaded below. How many more circles should be shaded so that $\frac{4}{9}$ of the set is shaded?

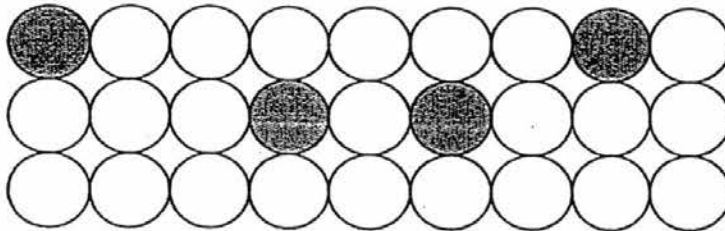

$$\begin{aligned} \text{Total} &= 9 \times 3 \\ &= 27 \end{aligned}$$

$$\begin{aligned} \frac{4}{9} \times \frac{27}{1} \\ \frac{4 \times 27}{9} \\ = 12 \end{aligned}$$

$$\begin{aligned} 12 - 4 \\ = 8 \text{ more} \end{aligned}$$

Ans : 8

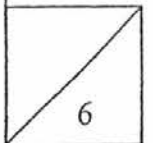

28. Devi had 100g of sugar. She used $\frac{2}{5}$ of the sugar. How much sugar was left?

Do not write
In this column

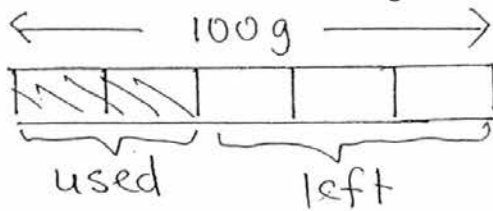

$$\begin{aligned} 5u &= 100 \\ 1u &= 100 \div 5 \\ &= 20 \end{aligned}$$

$$\begin{aligned} 3u &= 3 \times 20 \\ &= 60 \end{aligned}$$

Ans: 60 g

29. In the figure below, ABC is a straight line. Find $\angle m$.

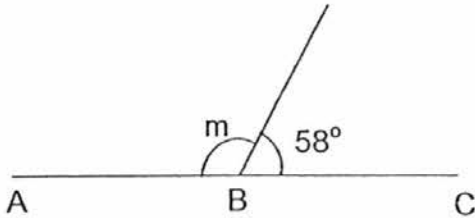

$$\begin{aligned} \angle m &= 180^\circ - 58^\circ \\ &= 122^\circ \end{aligned}$$

Ans: 122 °

30. PQRS is a rectangle. Find the value of $\angle w$.

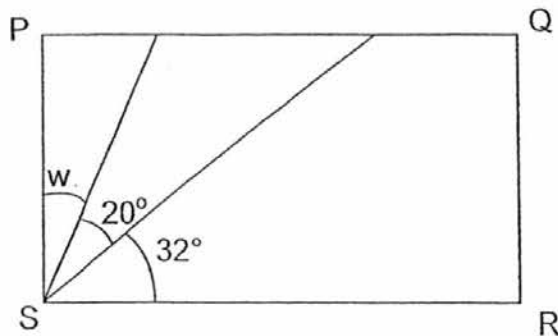

$$\begin{aligned} \angle w &= 90^\circ - 20^\circ - 32^\circ \\ &= 38^\circ \end{aligned}$$

Ans: 38 °

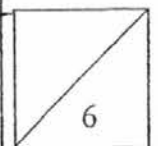

31. Shade and complete the figure using the bold line as the line of symmetry.

Do not write
In this column

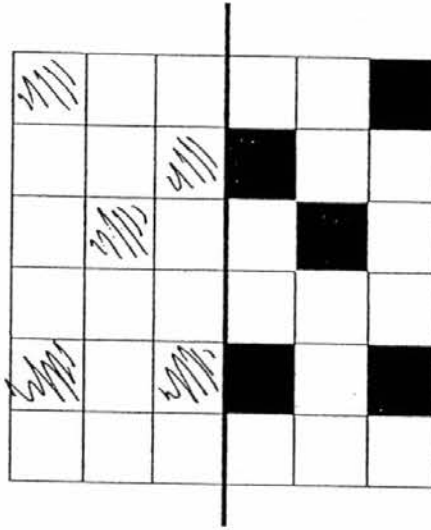

32. There are some pupils in the hall. $\frac{4}{9}$ of the pupils are boys and the rest are girls. There are 40 girls. How many pupils are there in the hall?

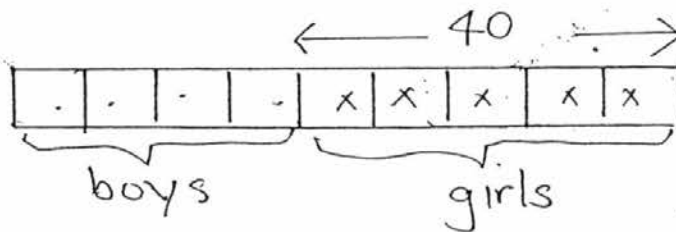

$$5u = 40$$

$$1u = 40 \div 5$$

$$= 8$$

$$9u = 9 \times 8$$

$$= 72$$

Ans: 72

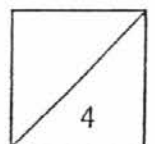

33. A string was 4m long. Christina gave $\frac{1}{4}$ of it to her sister and $\frac{3}{4}$ m to her friends. How much string had she given away?

$$\begin{aligned} \text{sister} &= \frac{1}{4} \times \frac{4}{1} \text{ m} \\ &= 1 \text{ m} \end{aligned}$$

$$\begin{aligned} \text{Length of string given away} &= 4 - 1 - \frac{3}{4} \\ &= 3 - \frac{3}{4} \\ &= \frac{24}{4} - \frac{3}{4} = \frac{21}{4} \text{ m} \end{aligned} \quad \text{Ans: } \underline{\frac{21}{4}} \text{ m}$$

34. A bag and a pair of shoes cost \$200. The bag cost 4 times as much as a pair of shoes. Find the cost of a pair of shoes.

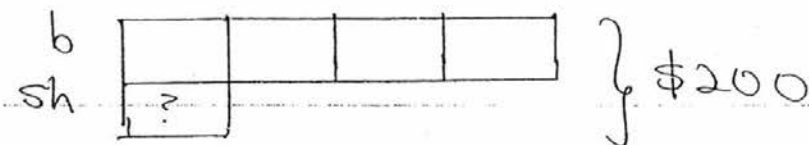

$$\begin{aligned} 5u &= 200 \\ 1u &= 200 \div 5 \\ &= 40 \end{aligned}$$

Ans: \$ 40

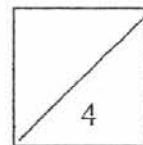

35. Fiona, Gillian and Heather had a total of 275 stickers. Fiona had thrice as many stickers as Gillian and Heather had 30 more stickers than Gillian. How many stickers did Gillian have?

Do not write
In this column

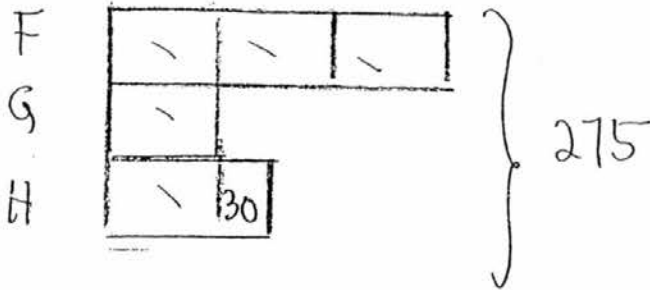

$$275 - 30 = 245$$

$$5u = 245$$

$$1u = 245 \div 5$$

$$= 49$$

Ans : 49

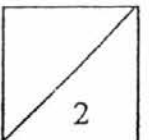

Section C: (30 marks)

For questions 36 to 43, show your working clearly in the space provided for each question and write your answer in the space provided. The number of marks available is shown in brackets [] at the end of each question or part-question.

Do not write
in this column

36. The figure below is made up of 3 identical rectangles. Find the lengths of
a) CD,
b) AF.

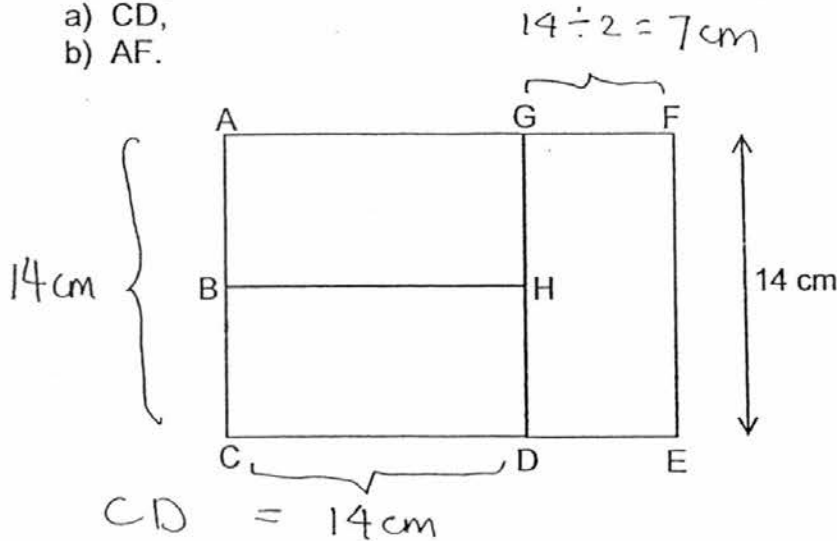

$$AF = 14 + 7 = 21$$

Ans: a) 14 cm [1]
b) 21 cm [2]

37. Kelly won \$888 in a lucky draw. She donated \$350 to charity and divided the rest equally among her 2 children. How much money did each child get?

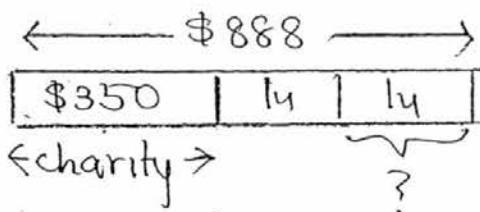

$$888 - 350 = 538$$

$$2u = 538$$

$$1u = 538 \div 2$$

$$= \$269$$

Ans: \$269 [3]

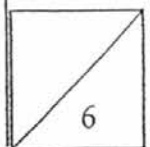

38. Sandy bought 15 boxes of erasers. There were 14 erasers in each box. She repacked the erasers into packets of 8 erasers each.
- How many packets would there be?
 - How many erasers were left over?

Do not write
in this column

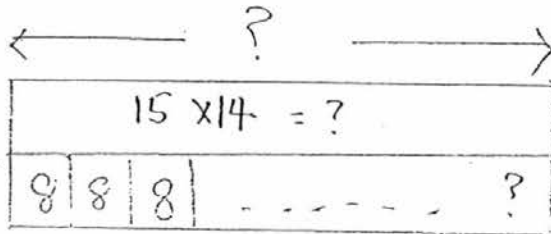

$$15 \times 14 = 210$$

$$\text{Pkts} \text{ --- } 210 \div 8 = 26 \text{ R } 2$$

www.testpaper.biz

Ans: a) 26 [3]
b) 2 [1]

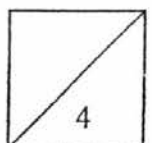

Do not write
in this column

39. A bottle of milk was $\frac{1}{2}$ full. After Linda drank 120 ml of milk from the bottle, it became $\frac{5}{12}$ full. How much milk was there in the bottle when it was $\frac{1}{2}$ full?

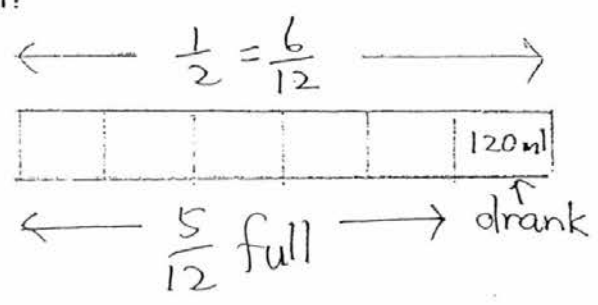

$$\frac{1}{2} = \frac{6}{12}$$

$$\begin{aligned} 1u &\text{ --- } 120 \\ 6u &\text{ --- } 120 \times 6 \\ &= 720 \text{ ml} \end{aligned}$$

Ans: 720 ml [4]

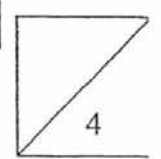

40. There were 250 more English books than Chinese books in a school library. When the librarian bought another 120 English books and 80 Chinese books, the total number of books in the library became 1500. How many English books were there at first?

Do not write
in this column

EL	✓	250	120	} 1500
CL	✓	80		

bought

$$250 + 120 + 80 = 450$$

$$2u = 1500 - 450$$

$$= 1050$$

$$1u = 1050 \div 2$$

$$= 525$$

$$EL = 525 + 250$$

$$= 775$$

Ans: 775 [4]

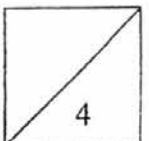

41. At a buffet, $\frac{1}{8}$ of the sticks of satay were beef, $\frac{1}{4}$ of them were mutton and the rest were chicken. Given that there were 225 sticks of chicken satay, how many sticks of satay were there at the buffet?

Do not write
in this column

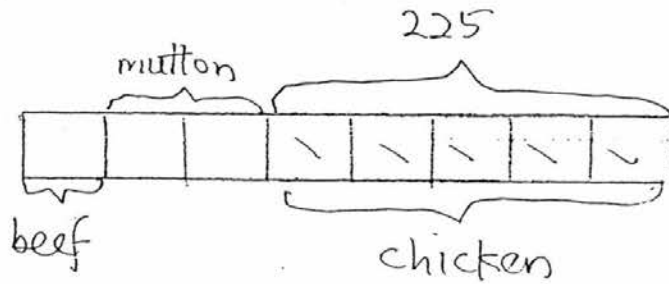

$$5u \text{ --- } 225$$

$$1u \text{ --- } 225 \div 5$$

$$= 45$$

$$8u \text{ --- } 45 \times 8$$

$$= 360$$

Ans: 360 [4]

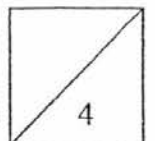

42. Emma has 180 erasers. She has 5 times as many erasers as Janice.
 a) How many erasers must Emma give Janice so that they will have the same number of erasers?
 b) How many erasers do they have altogether?

Do not write
in this column

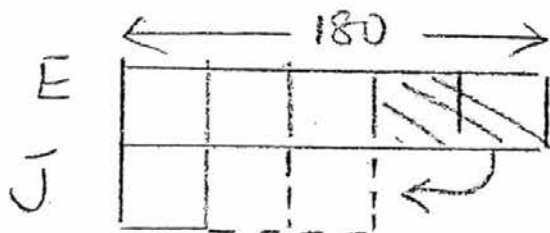

$$5u = 180$$

$$1u = 180 \div 5$$

$$= 36$$

a) $2u = 36 \times 2$

$$= 72$$

b) $6u = 36 \times 6$

$$= 216$$

Ans: a) 72 [2]

b) 216 [2]

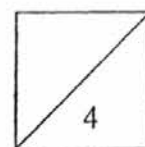

43. Ruth had 36 more sweets than Kayla at first. After Kayla had eaten 15 of her sweets, Ruth had four times as many sweets as Kayla. How many sweets did Ruth and Kayla have in total at first?

Do not write
in this column

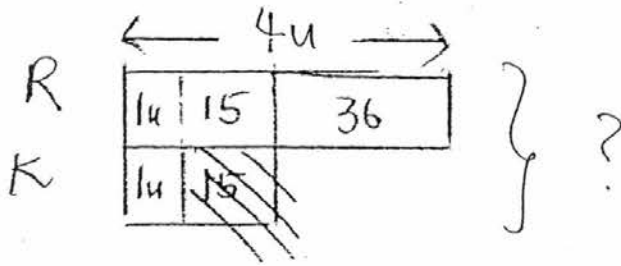

$$4u - 1u = 3u$$

$$15 + 36 = 51$$

$$3u = 51$$

$$1u = 51 \div 3$$

$$= 17$$

$$R = 17 + 15 + 36$$

$$= 68$$

$$K = 17 + 15$$

$$= 32$$

$$\text{Total} = 68 + 32$$

$$= 100$$

Ans: 100 [4]

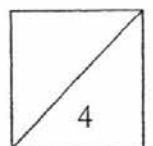

END OF PAPER
PLEASE CHECK YOUR WORK