



RAFFLES GIRLS' PRIMARY SCHOOL

**End-of-Year Examination
2020**

Section A	50
Section B	40
Your score out of 90	
Parent's signature	

Name : _____

Index No.: _____

Class: P4_____

28 October 2020

SCIENCE

Duration: 1 h 30 min

SECTION A (25 x 2 marks)

For each question from 1 to 25, four options are given. One of them is the correct answer. Make your choice (1, 2, 3 or 4). Shade the correct oval (1, 2, 3 or 4) on the Optical Answer Sheet (OAS) provided.

1. Which animal has a 3-stage life cycle?

(1)

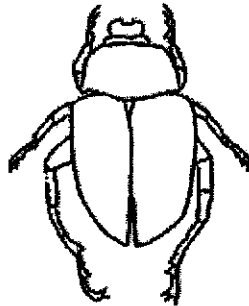

beetle

(2)



butterfly

(3)



mosquito

(4)



grasshopper

2. Which animal has a pupa as a stage in its life cycle?

- (1) frog
- (2) chicken
- (3) mosquito
- (4) cockroach

3. The diagram shows the life cycle of a plant.

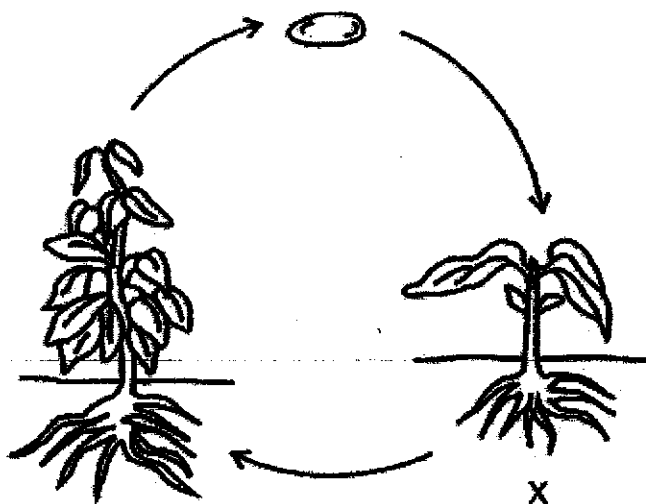

What is the stage marked X?

- (1) egg
- (2) seed
- (3) adult plant
- (4) young plant

4. In which part of the digestive system is water absorbed?

- (1) mouth
- (2) stomach
- (3) small intestine
- (4) large intestine

5. The diagram below shows a pair of spectacles.



The frame of the spectacles is made of metal because metal _____.

- (1) can reflect light
- (2) can sink in water
- (3) does not break easily
- (4) does not allow light to pass through

6. Matter is anything that has mass and occupies space.
Which one of the following is **NOT** matter?

- (1) air
- (2) flour
- (3) shadow
- (4) orange juice

7. Which one of the following is a source of light?

(1)

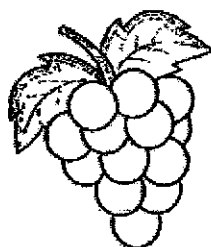

grapes

(2)



moon

(3)

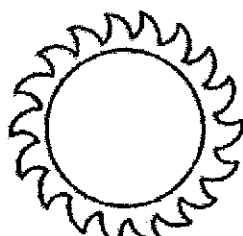

sun

(4)



cloud

8. Which one of the following is **NOT** a source of heat?

- (1) The sun
- (2) A lighted bulb
- (3) A lighted candle
- (4) A woolen jacket

9. Lucy places a metal spoon in a bowl of hot soup as shown below.

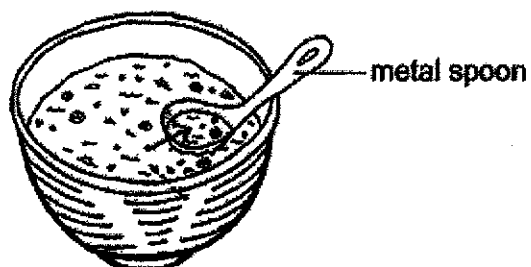

a bowl of hot soup

After a while, the spoon becomes hot.
Which one of the following explains this?

- (1) The spoon loses heat to the bowl.
- (2) The spoon loses heat to the soup.
- (3) The spoon gains heat from the soup.
- (4) The soup gains heat from the spoon.

10. In which one of the following would the two magnets push each other away?

(1)

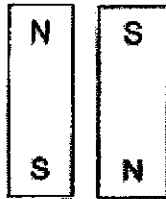

(2)



(3)

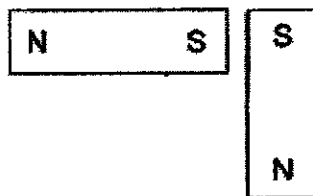

(4)

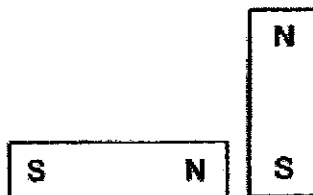

11. The diagram below shows how a plant grows from a seed over a period of time.

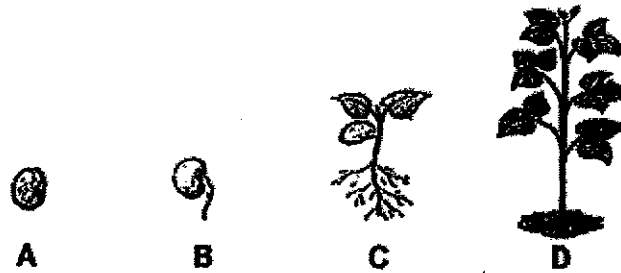

At which stage(s) of its growth, A, B, C or D, is/are the plant **NOT** able to make its own food?

- (1) B only
 - (2) A and B only
 - (3) C and D only
 - (4) A, B and C only
12. The graph below shows the number of days in each stage of the life cycle of insect Y.

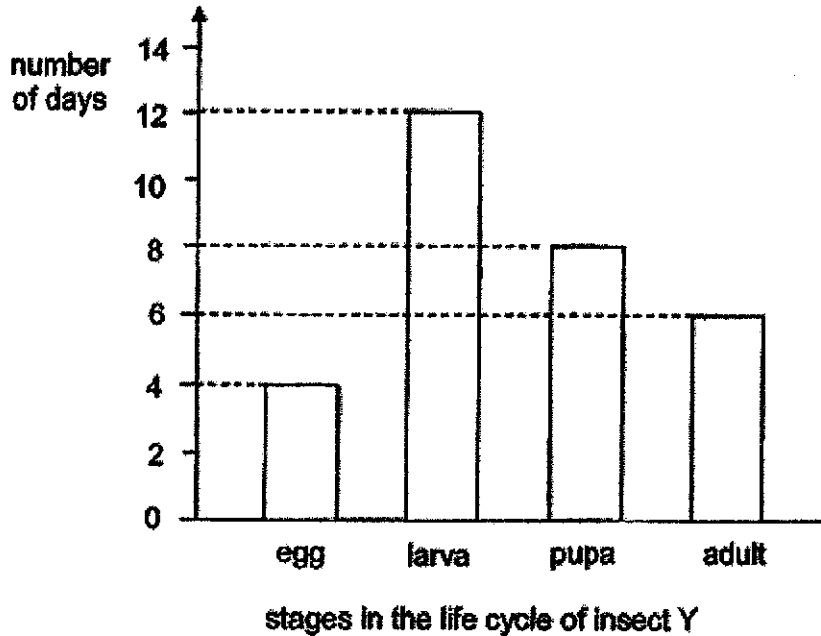

Based on the graph above, which of these statements about insect Y is **NOT** correct?

- (1) Insect Y has a 4-stage life cycle.
- (2) Insect Y hatches four days after the egg is laid
- (3) Insect Y takes thirty days to become an adult.
- (4) Insect Y spends longer time in larva stage compared to other stages.

13. The diagram below shows part of the large intestine in the digestive system. Substances P and Q are found in the large intestine.

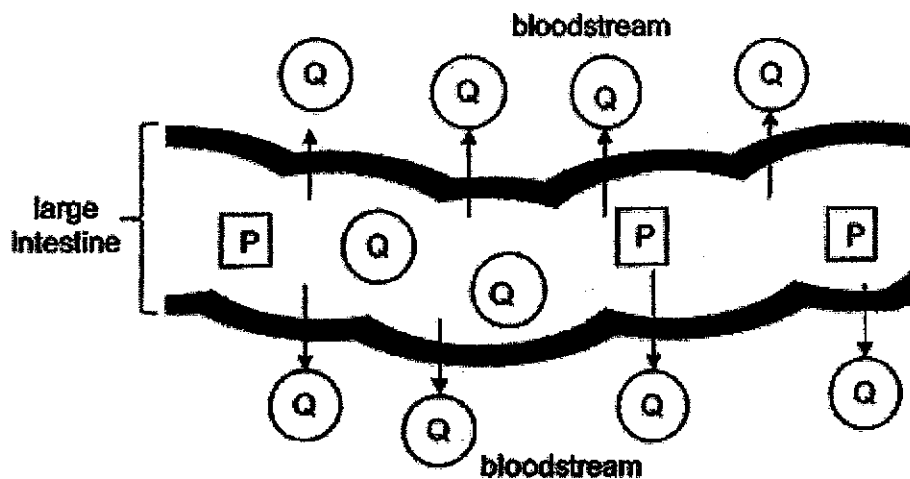

Which one of the following identifies substances P and Q correctly?

	P	Q
(1)	water	digested food
(2)	digested food	water
(3)	undigested food	water
(4)	undigested food	digested food

14. The diagram below shows a plant.

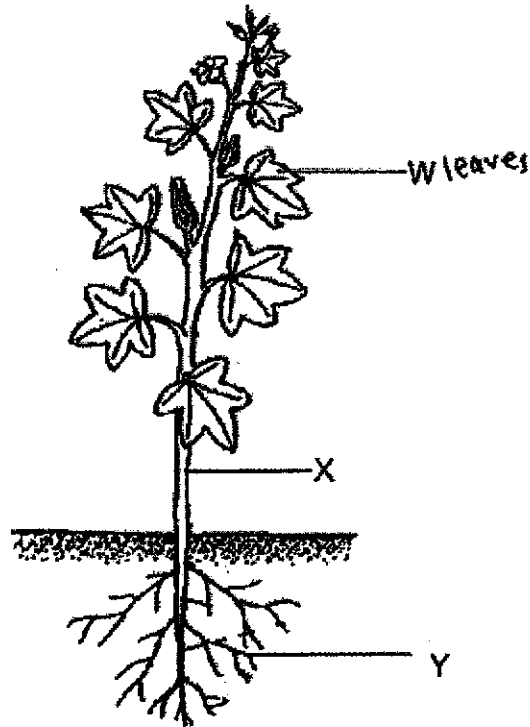

Which one of the following identifies the function of the parts W, X and Y correctly?

	Function of W	Function of X	Function of Y
(1)	makes food for the plant	transports water and food to all parts of the plant	holds the plant firmly to the ground
(2)	makes food for the plant	holds the plant firmly to the ground	transports water and food to all parts of the plant
(3)	transports water and food to all parts of the plant	makes food for the plant	holds the plant firmly to the ground
(4)	transports water and food to all parts of the plant	holds the plant firmly to the ground	makes food for the plant

(1)

15. James wanted to find out if the amount of roots affect the volume of water absorbed by a plant. He placed the two set-ups near a window as shown below.

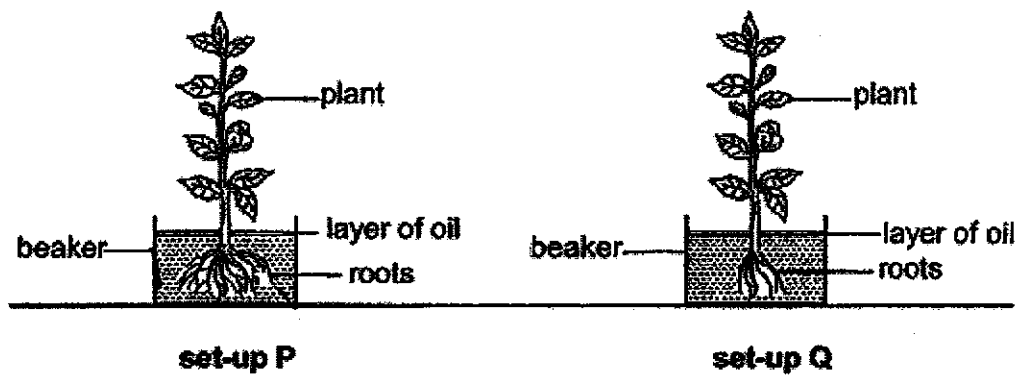

He recorded the volume of water left in the beaker for five days.

Which one of the following graphs shows his results correctly?

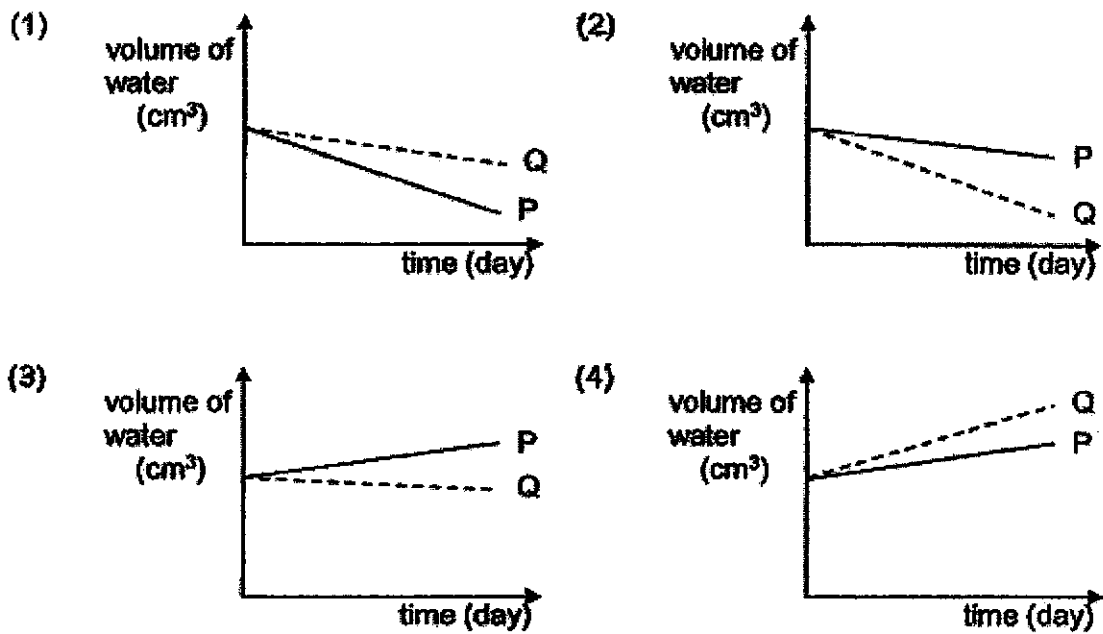

16. Joy set up an experiment as shown below to test the absorbency of four different materials, R, S, T and U. The materials are of identical length, size and thickness.

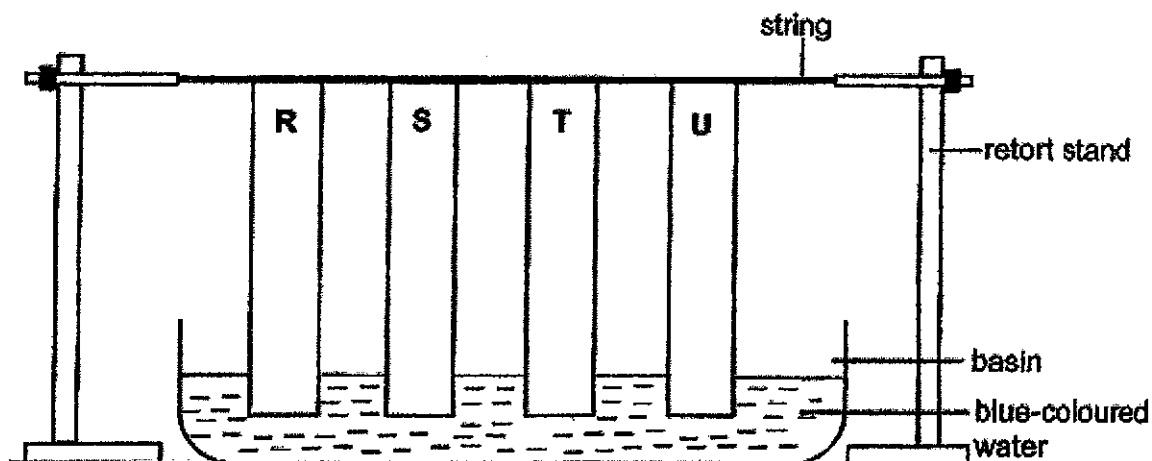

After half an hour, Joy removed the materials from the basin and string and measured the distance 'd' of each material that was stained blue. She recorded the results in the table below.

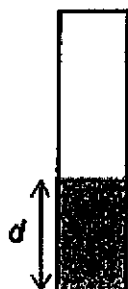

Material	R	S	T	U
Distance 'd' of material stained blue (cm)	0	8	12	10

The umbrella as shown below is used to keep Joy dry on a rainy day.



Based on the results in the above table, which material is most suitable to make part Y of the umbrella?

- (1) R
- (2) S
- (3) T
- (4) U

17. Sam used some clay to make a cylinder. Then he reshaped the same piece of clay that was used to make the cylinder into a cube as shown in diagrams below.

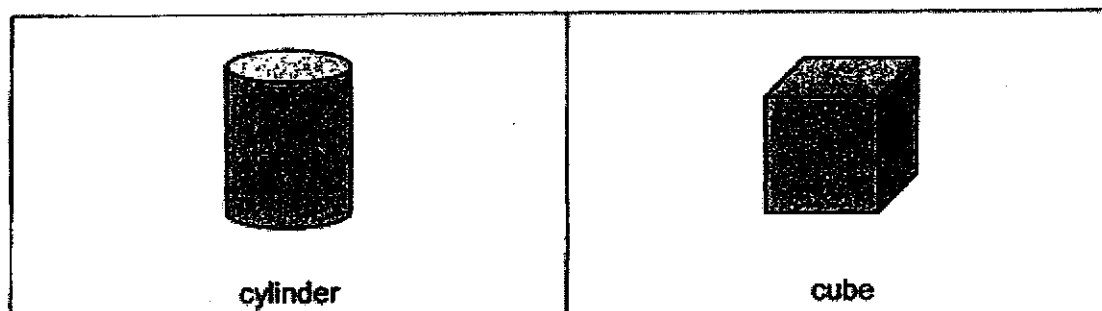

In what ways are the cylinder and cube similar to each other?

Both the cylinder and the cube have the same _____.

- A mass
- B shape
- C volume

- (1) A only
- (2) A and B only
- (3) A and C only
- (4) B and C only

18. Alex wanted to find out the mass of the lemons using the set-up shown in the diagram below. He placed five lemons and a wooden block on a balance. He repeated the experiment by replacing the wooden block with other wooden blocks of different masses.

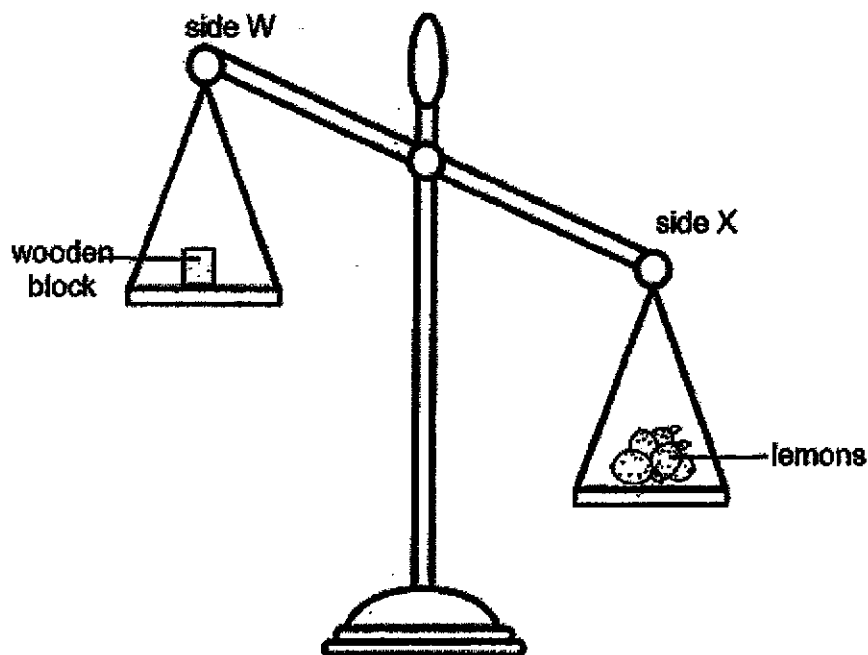

Then he recorded his observations in the table below.

Mass of wooden block (g)	Side that tilted downwards
500	X
600	X
700	W
800	W

Based on the results above, which one of the following is most likely to be the mass of five lemons?

- (1) 600 g
 - (2) 650 g
 - (3) 700 g
 - (4) 750 g
19. Which one of the following statements about light is **NOT** correct?
- (1) Light occupies space.
 - (2) Light can be reflected.
 - (3) Light is a form of energy.
 - (4) Light travels in a straight line.

20. The diagram below shows the layout of the stage for a puppet performance.

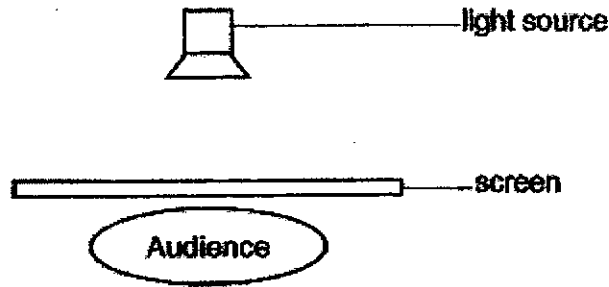

Three puppets, A, B and C, were placed between the light source and the screen. The three puppets were of the same height but different shapes. The audience saw the shadows of the puppets cast on the screen as shown below.

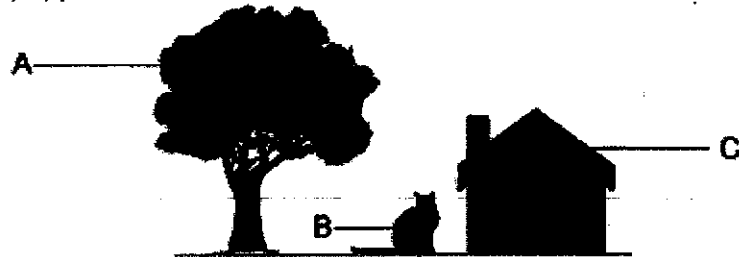

Which one of the following shows the correct position of the three puppets, A, B and C?

<p>(1)</p>	<p>(2)</p>
<p>(3)</p>	<p>(4)</p>

- 21- The diagram below shows a picture of an opened umbrella.

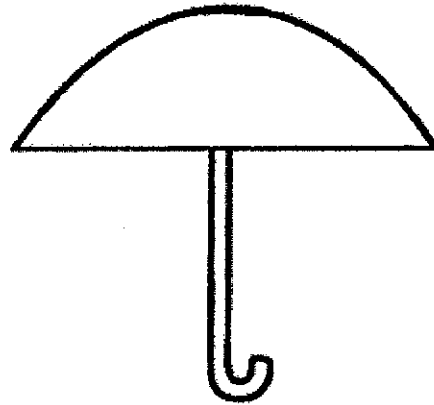

The opened umbrella was placed between a light source and a screen in different positions.

Which one of the following is **NOT** likely to be the shadow of the opened umbrella?

(1)



(2)

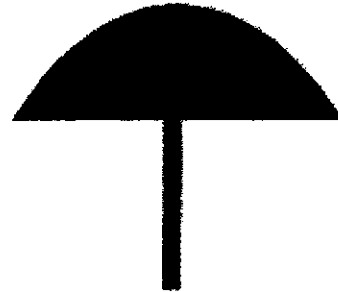

(3)

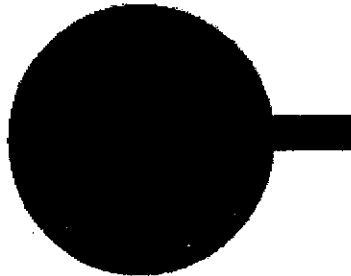

(4)

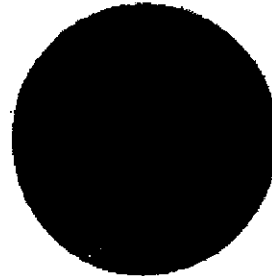

22. Kate filled three pails, X, Y and Z, with the same amount of water with different temperatures. Kate dipped her left hand into pail X and right hand into pail Y for three minutes.

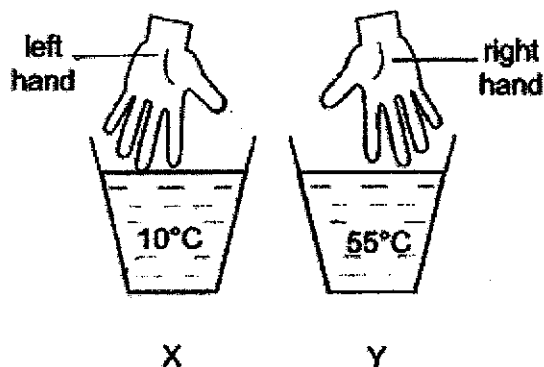

She then put both her hands into pail Z.

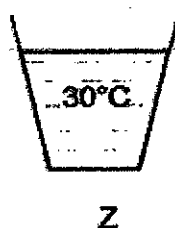

Which one of the following correctly describes how Kate's hands felt in pail Z?

	Left Hand	Right Hand
(1)	warmer	warmer
(2)	cooler	cooler
(3)	warmer	cooler
(4)	cooler	warmer

23. Peter poured the same volume of water at 25°C into two identical containers, A and B, as shown below. Both containers A and B were placed on a heater.

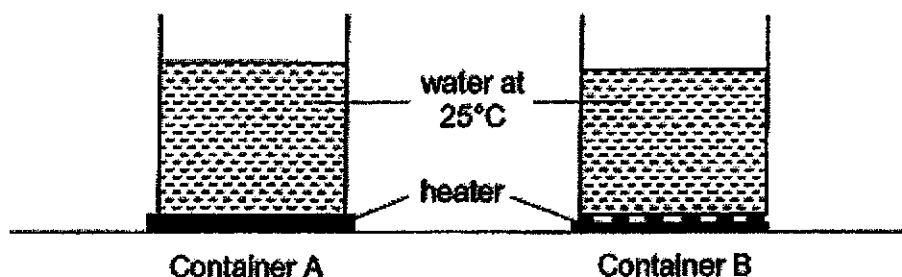

After 15 minutes, which one of the following comparisons of the amount of heat in the water in both containers and explanation is correct?

	Amount of heat in the water after 15 minutes	Explanation
(1)	Water in both containers had the same amount of heat.	Temperature of water was the same in both containers.
(2)	Water in both containers had same amount of heat.	Both containers were made of the same material.
(3)	Water in container A had more heat than the water in container B.	Container A had a larger surface area in contact with the heater and gained more heat.
(4)	Water in container B had more heat than the water in container A.	Heat was conducted more quickly to the water in container B.

24. A tray of iron pins is placed below the magnets of identical size. The diagram below shows the different number of iron pins that are attracted to the different magnets A, B, C and D.

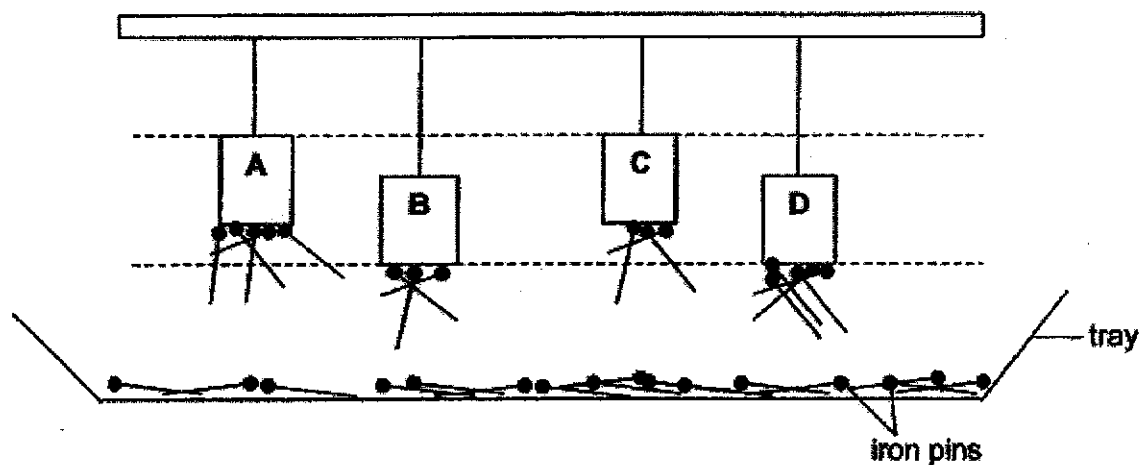

Based on the observations above, which one of the following is the strongest magnet?

- (1) A
- (2) B
- (3) C
- (4) D

25. Jane hung object X on a spring as shown in diagram 1. Then she placed object Y directly below object X. She observed that the length of the spring became shorter as shown in diagram 2.

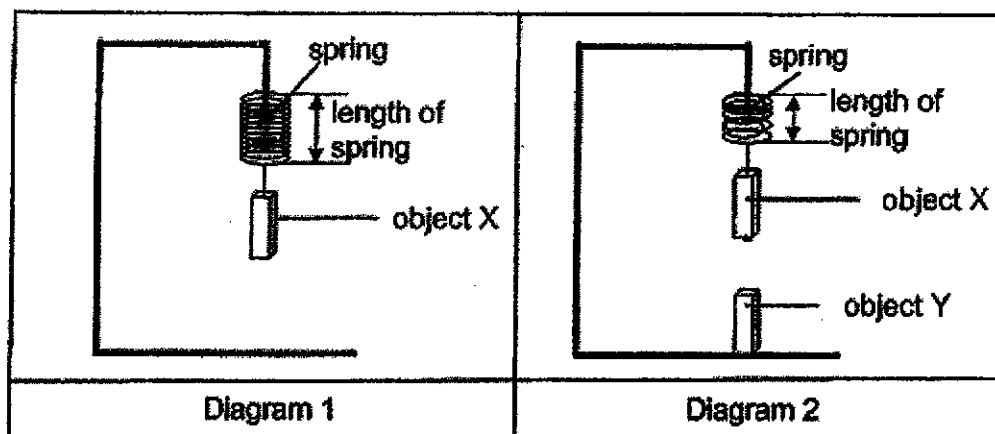

Based on her observations, which of the following statement(s) is/are correct?

- A Objects X and Y were magnets.
 - B Unlike poles of objects X and Y were facing each other.
 - C Object X was non-magnetic and object Y was a magnet.
- (1) A only
 (2) C only
 (3) A and B only
 (4) B and C only

Name : _____ Index No: _____ Class: P4 _____

**SECTION B (40 marks)**

For questions 26 to 37, write your answers clearly in the spaces provided. The number of marks available is shown in brackets [] at the end of each question or part question.

26. The diagram shows part of the human digestive system.

(a) Tick one box to show where the gullet is.

[1]

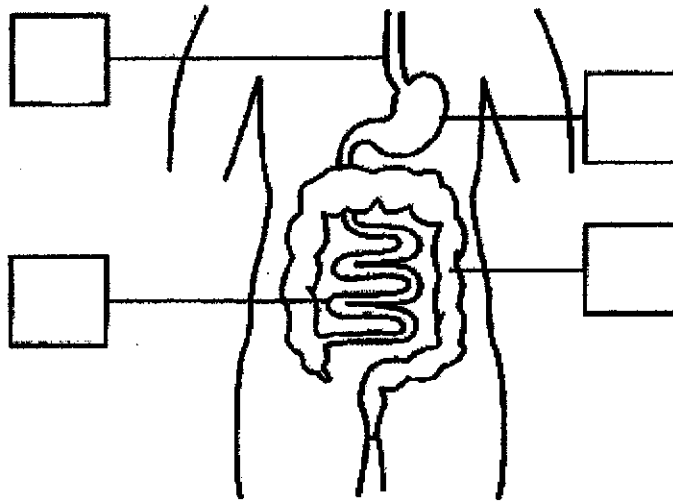

(b) Fill in the blank using the following helping words.

[1]

rectum	stomach	small intestine	mouth
--------	---------	-----------------	-------

Food from the gullet is next passed on to the _____.

20

Score	2
-------	---

2020 P4 Science EYE

27. The diagram below shows a plant.

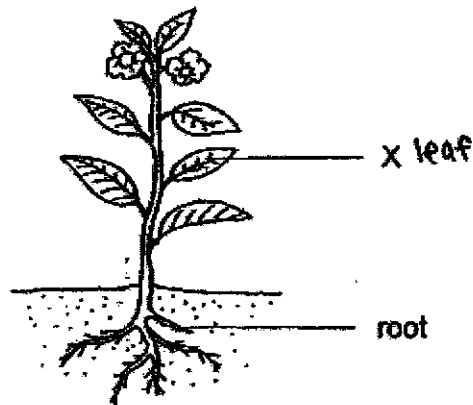

(a) Name the plant part. [1]

X: _____

(b) The roots take in _____ for the plant. [1]

(c) The diagram below shows a representation of the transport system of a flowering plant.

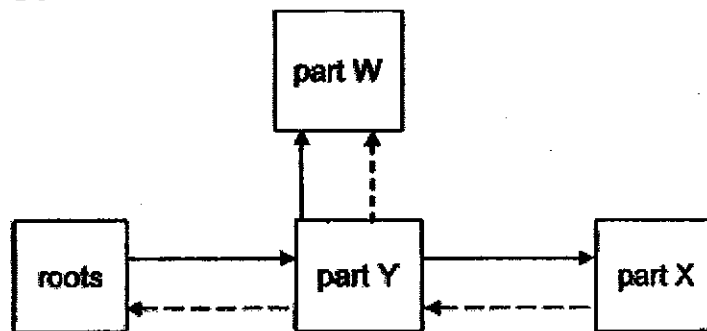

The arrows \longrightarrow and \dashrightarrow show the direction in which food and water are transported in a plant.

Write 'food' or 'water' in the correct blanks below. [2]

(i) \longrightarrow Transports _____

(ii) \dashrightarrow Transports _____

(iii) Name plant part W. [1]

W: _____

Score	5
-------	---

2020 P4 Science EYE

28. The picture below shows a cup of hot tea.

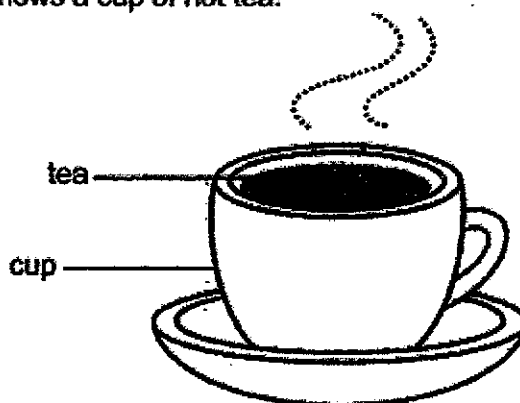

Circle the correct state for the following things.

(a) tea: solid / liquid / gas [1]

(b) cup: solid / liquid / gas [1]

29. The diagram below shows a beaker of milk.

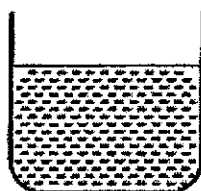

Fill in the blanks using the correct words in the box.

solid	liquid	gas
increases	remains unchanged	decreases

(a) When heat is removed from the milk, its temperature _____ [1]

(b) The beaker of milk is put in the freezer. After some time, the milk will change its state to become a _____ [1]

Score	/
	4

30. Susan placed a magnet near an aluminium rod as shown below.
The aluminium rod did not move towards the magnet.



(a) The magnet did not _____ the aluminium rod. [1]

(b) Choose the correct word from the box to answer the question below.



The aluminium rod is made of a _____ material. [1]

Score	2
-------	---

31. The diagram below shows the life cycle of a mosquito and a chicken.

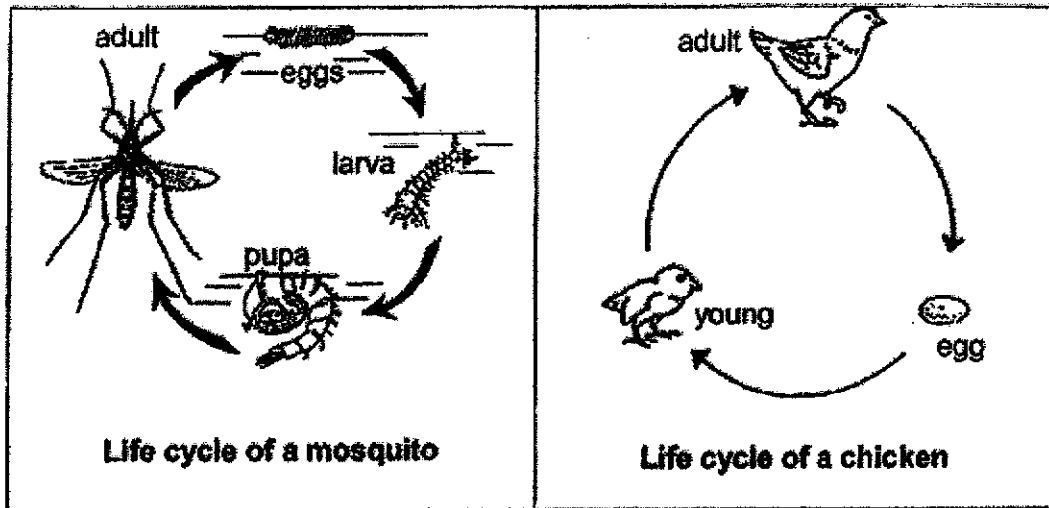

(a) Based on your observation, state one similarity and one difference between the two life cycles. [Do NOT compare size, shape, colour and body covering.] [2]

Similarity	 <hr/> <hr/>
Difference	 <hr/> <hr/>

Continue on next page

Score	2
-------	---

Continued from previous page

The diagram below shows a flowering plant at three stages, P, Q and R.

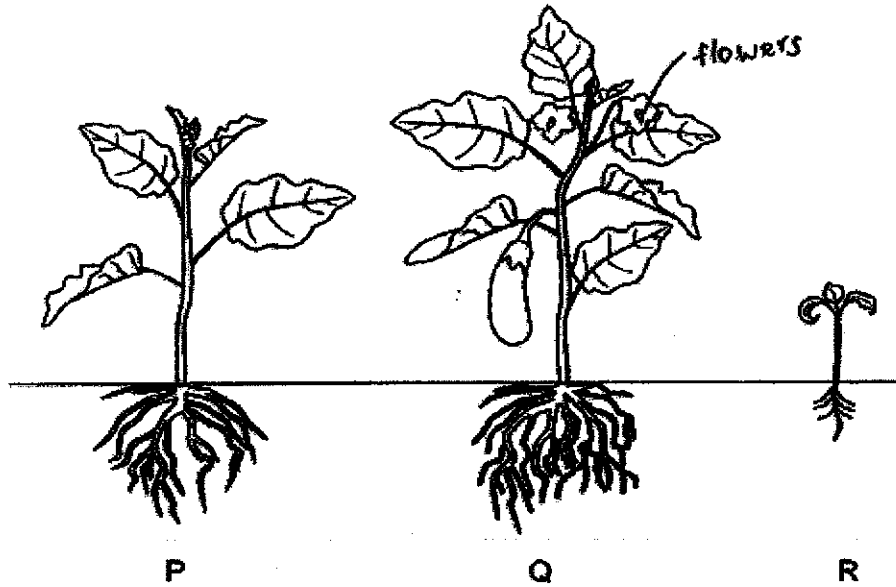

- (b) At which stage, P, Q or R, is the plant at its adult stage? [1]

- (c) Based on your observation, give a reason for your answer in (b). [1]
[Do NOT compare size and shape.]

Score	2
-------	---

32. The graph below shows the amount of digested and undigested food in the different organs in the digestive system.

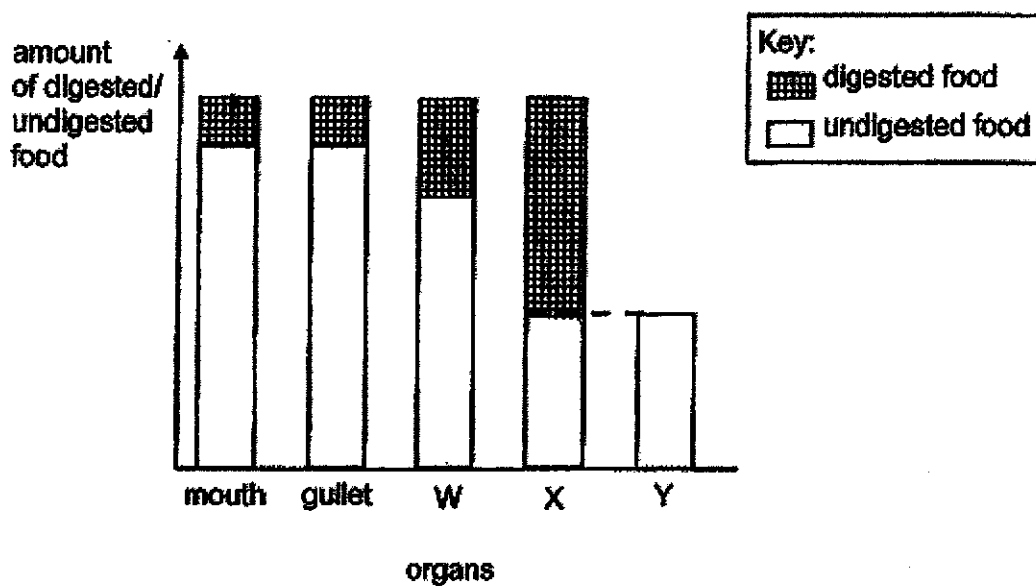

- (a) State a reason why the amount of digested food in the gullet is the same as the amount of digested food in the mouth. [1]

- (b) What organ in the digestive system could Y be? Explain your answer. [2]

Score	3
-------	---

33. The table below shows the physical properties of four materials, W, X, Y and Z. A tick (✓) shows the presence of the property.

Properties	Materials			
	W	X	Y	Z
Is it flexible?	✓			✓
Is it waterproof	✓	✓	✓	
Does it allow light to pass through?		✓		

Based on the given information, materials W, X, Y and Z have been classified into two groups as shown below.

- (a) In the classification table below, write the possible headings for the two groups in (i) and (ii). [1]
- (b) Fill in the blanks in (iii) and (iv) with the correct materials, X or Z. [1]

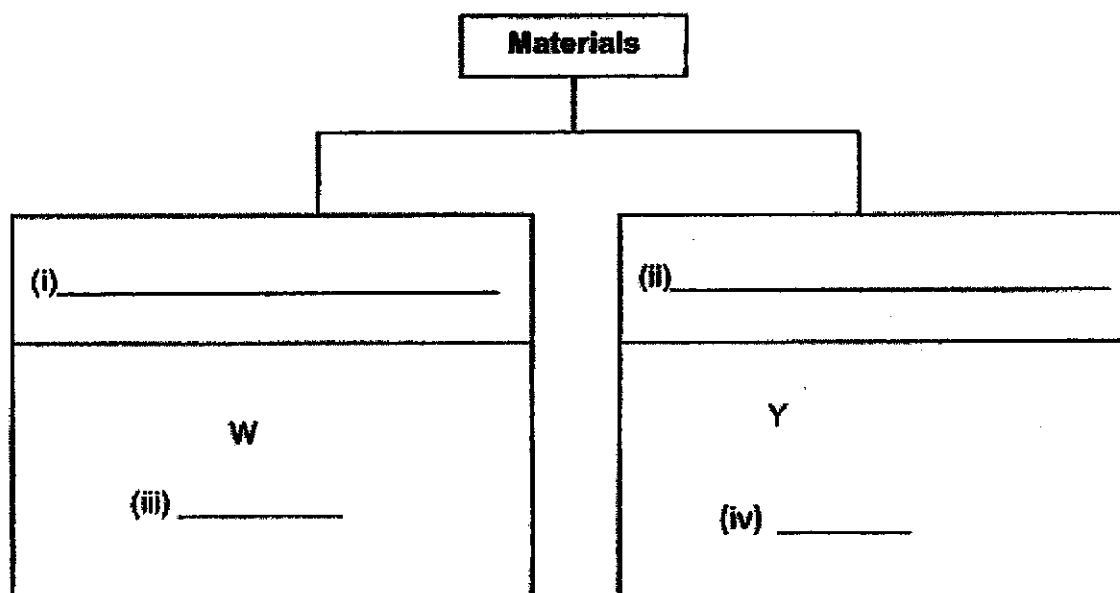

Continue on next page

Score	2
-------	---

Continued from previous page

The diagram below shows a fish tank.

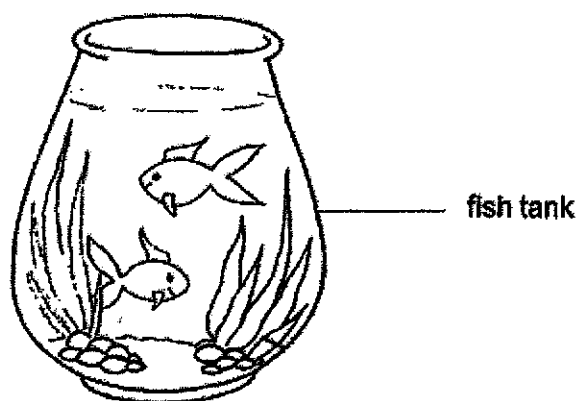

- (c) Based on the properties of the materials given in the table, which material, W, X, Y or Z, should be use for making the fish tank? Give two reasons for your answer. [2]

Material : _____

Reason 1: _____

Reason 2: _____

Score	2
-------	---

34. The diagram below shows a container with a capacity of 500 cm^3 . It was filled with 200 cm^3 of water. Two syringes, filled with 100 cm^3 of water and air respectively, were attached to the container.

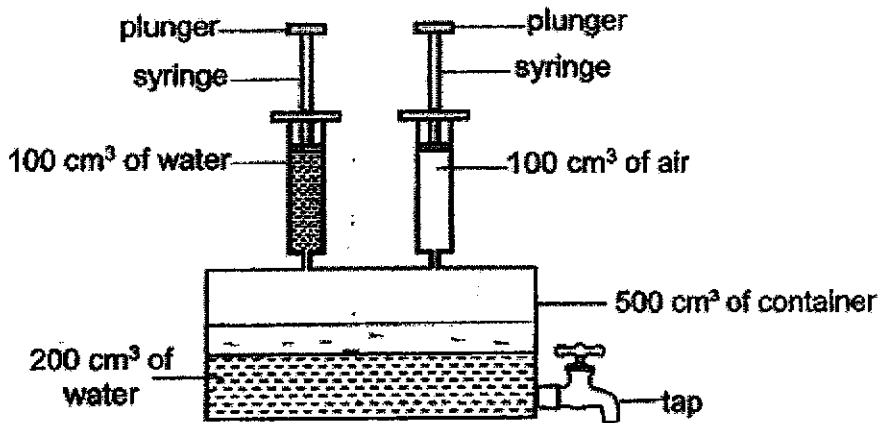

- (a) In the table below, put a tick (\checkmark) in the correct boxes that show how the volume of water and air in the container would change after the plungers of both syringes were pushed down completely. [2]

	Volume		
	Increase	Decrease	Remains the same
Water			
Air			

- (b) Without changing any of the apparatus, state one way to increase the volume of air in the container. Explain your answer. [2]

Score	4
-------	---

35. Emir conducted an experiment as shown below. In a black box, he placed four different materials, W, X, Y and Z, between a torch and a light sensor, one at a time.

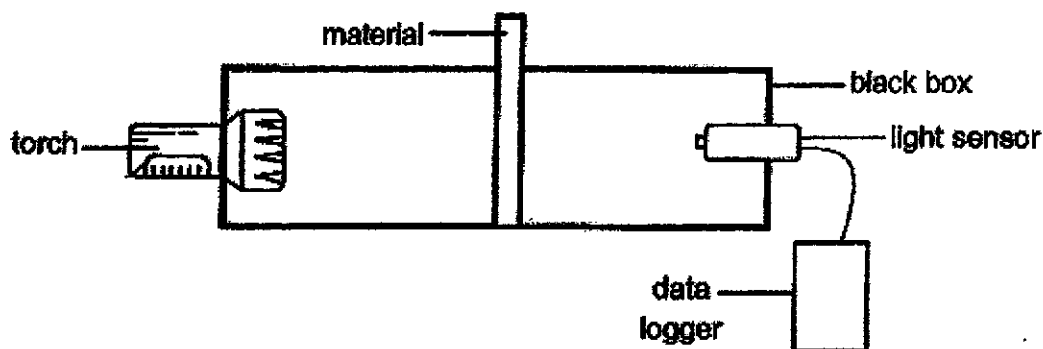

Emir turned on the torch and recorded the amount of light detected by the light sensor in the table below.

Material	Amount of light detected by light sensor (unit)
W	0
X	1450
Y	875
Z	100

- (a) Which of these variable(s) should Emir keep the same? Put a tick (✓) in the correct box(es). [1]

Variable	Keep the same (✓)
Type of material	
Thickness of material	
Amount of light detected by the light sensor	
Distance between the torch and the material	

Continue on next page

Score	1
-------	---

Continued from previous page

Emir wanted to choose two materials to make an envelope to send letters to his friends. One of the materials would be used for part P and the other material for part Q of the envelope as shown below.

Part P would hide the writing in the letter while part Q would enable him to see the address printed on the letter clearly.

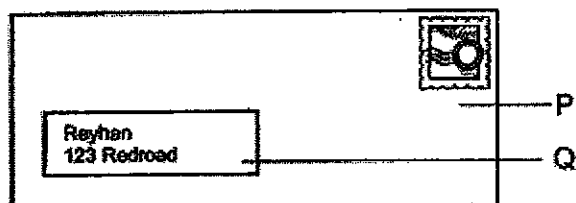

- (b) Based on the results of his experiment, which materials, W, X, Y or Z, would best be used to make parts P and Q of the envelope? [2]

(i) P: _____

(ii) Q: _____

- (c) Give a reason for answer in b (i). [1]

Score	3
-------	---

36. Sophie took a bottle of cold milk out of the fridge as shown below.

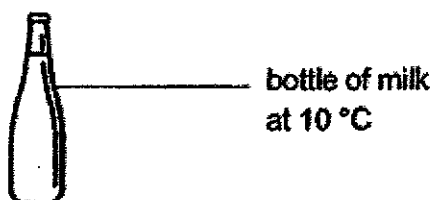

There were three identical basins, R, S and T, each containing different amount of water at a temperature of 90 °C. Sophie wanted to warm the cold milk by putting it into the basins of water.

Basin R	Basin S	Basin T
Temperature of water: 90 °C Amount of water : 30 ml	Temperature of water: 90 °C Amount of water : 60 ml	Temperature of water: 90 °C Amount of water : 90 ml

- (a) In which basin of water, R, S or T, would the bottle of milk become warm least quickly after five minutes? Explain your answer. [2]

- (b) After ten hours, what would most likely to be the temperature of water in the basin and the milk placed in a room with a temperature of 30 °C. [2]

		Temperature (°C)
(i)	water in basin	
(ii)	milk in the bottle	

Score	4
-------	---

37. Peter used the stroking method to make the nail a temporary magnet as shown in the diagram.

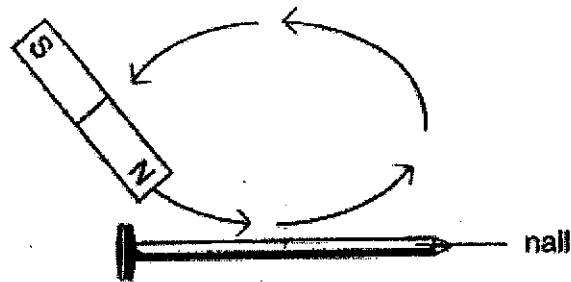

- (a) Suggest a material which the nail shown above is made of. [1]

Peter connected the nail in an electrical circuit as shown in the diagram below. He observed that the nail attracted a few paper clips.

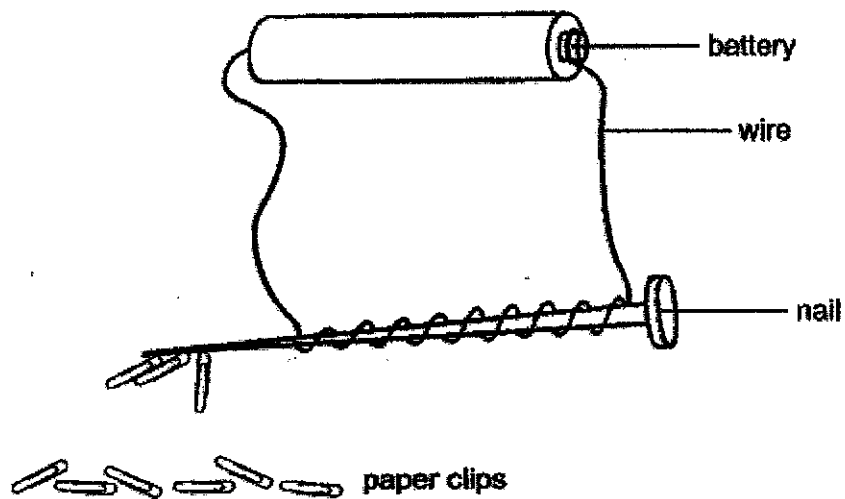

- (b) Explain why the nail was able to attract the steel paper clips. [1]

Continue on next page

Score	2
-------	---

Continued from previous page

Peter repeated the experiment by replacing the nail with an aluminium nail. He increased the number of turns of wire round the aluminium nail as shown below.

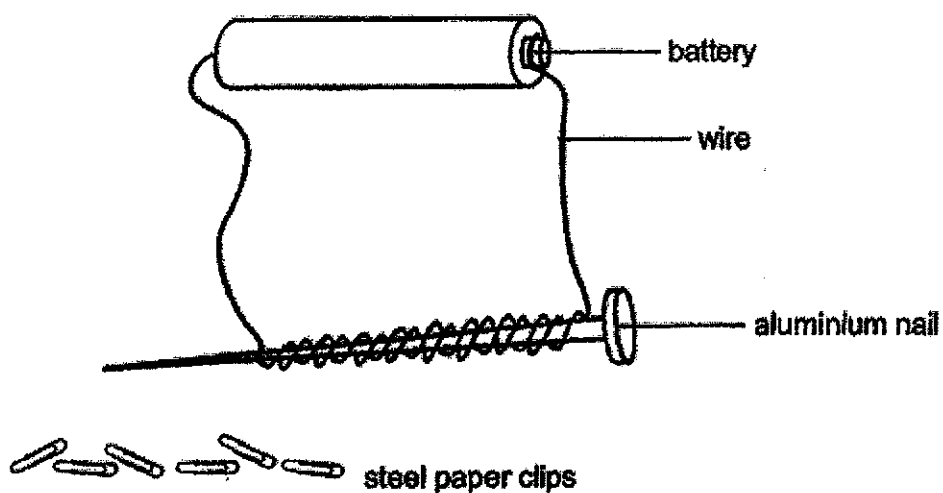

- (c) Predict the number of paper clips attracted to the aluminium nail. Explain your answer.

[2]

End of Paper
34

Score	2
-------	---

2020 P4 Science EYE

SCHOOL : RAFFLES GIRL'S PRIMARY SCHOOL
 LEVEL : PRIMARY 4
 SUBJECT : SCIENCE
 TERM : 2020 SA2

SECTION A

Q 1	Q2	Q3	Q4	Q5	Q6	Q7	Q8	Q9	Q10
4	3	4	4	3	3	3	4	3	3
Q 11	Q12	Q13	Q14	Q15	Q16	Q17	Q18	Q19	Q20
2	3	3	1	1	1	3	2	1	4
Q 21	Q22	Q23	Q24	Q25					
3	3	3	1	1					

SECTION B

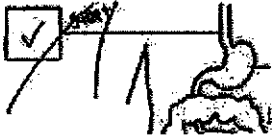
Q26)	<p>(a) Answer</p>  <p>(b) Stomach</p>
Q27)	<p>(a) X: Leaf</p> <p>(b) Water</p> <p>(c) (i) water</p> <p>(ii) food</p> <p>(iii) W: flower</p>
Q28)	<p>(a) Liquid</p> <p>(b) Solid</p>
Q29)	<p>(a) Decreases</p> <p>(b) Solid</p>

Q30)	<p>(a) Attract</p> <p>(b) Non-magnetic</p>
Q31)	<p>(a) Similarity: Both mosquito and chicken have an egg stage. Difference: Mosquito has a 4-stage life cycle while chicken has a 3-stage life cycle.</p> <p>(b) Q</p> <p>(c) The plant in stage Q is an adult plant as it has flowers/fruit.</p>
Q32)	<p>(a) There were no digestive juices in gullet so there was digestion happening in gullet. Thus, amount of digested food in gullet is same as the amount of digested food in mouth.</p> <p>(b) C: large intestine E: there is no digested food in bar Y/large intestine. R: large intestine does not produce digested juices. Digested food is absorbed by the small intestine.</p>
Q33)	<p>(a) (i) Flexible (ii) not flexible</p> <p>(b) (iii) Z (iv) X</p> <p>(c) Material: X Reason 1: Material X is waterproof so water in fish tank would not flow out. Reason 2: Material X allows light to pass through, so the fish inside fish tank can be seen. Reason 3: It is stiff/not flexible as the tank will not collapse/the tank could hold its shape.</p>
Q34)	<p>(a) Water: Increase Air: Decrease</p> <p>(b) C: Turn on the tap and remove some water from the container. R: Air does not have a definite volume and will take up all the available space in the container. Air will take up the space previously occupied by water in the container.</p>
Q35)	<p>(a) Thickness of material Distance between the torch and the material</p>

	<p>(b) (i) P: W (ii) Q: X</p> <p>(c) E: There was no light detected by the light sensor R: No light can pass through the material. It is opaque.</p>
Q36)	<p>(a) O: water in Basin R. I: Basin R had the least volume of water at 90°C. C: Basin R has the least amount of heat so the water in Basin R would warm the milk least quickly. The milk gained the least amount of heat from the water in Basin R.</p> <p>(b) (i) 30°C (ii) 30°C</p>
Q37)	<p>(a) Iron</p> <p>(b) The nail has able to attract the steel paper clips. I: The nail was mode into a temporary magnet using the electrical method. C: The nail, exerts a magnetic force on the magnetic paper clips.</p> <p>(c) O: O I: Aluminium is a non-magnetic material. C: Non-magnetic material cannot be magnetised to become a temporary magnet. Thus, the aluminium nail would not attract any paper clips.</p>

