

C42

NANYANG PRIMARY SCHOOL

PRIMARY 4 SCIENCE

SECOND CONTINUAL ASSESSMENT 2005

Name . _____ () Date : 22nd Aug 05

Class : Primary 4 (D) Duration : 1 h 45 min

Parent's signature: _____ Score :

80

Section A (25 x 2 marks = 50 marks)

For each question from 1 to 25, four options are given. One of them is the correct answer. Make your choice (1, 2, 3 or 4). Shade the correct oval (1, 2, 3 or 4) on the Optical Answer Sheet provided.

1. Which of the following are classified correctly?

	Matter	Non-matter
(1)	snow	dew
(2)	thunder	dust
(3)	clouds	shadow
(4)	laser	air

()

2. Zainal carried out the steps as shown below:

Step 1: Weigh an inflated basketball.

Step 2: Let the air out and weigh the basketball.

Step 3: Pump air into the basketball until no more air could be introduced. Then weigh the ball.

Which one of the following is the most likely set of results that he recorded?

	Mass of ball (g)		
	Step 1	Step 2	Step 3
(1)	455	465	447
(2)	455	448	437
(3)	455	426	472
(4)	455	460	472

()

3. Study the classification chart below

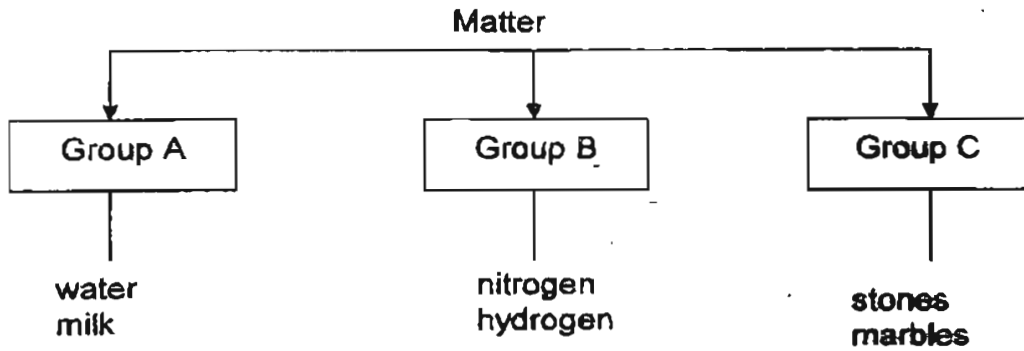

Which of the following are correctly classified under the different groups, A, B and C ?

	<u>Group A</u>	<u>Group B</u>	<u>Group C</u>
(1)	honey	plasticine	oxygen
(2)	honey	oxygen	plasticine
(3)	alcohol	helium	carbon dioxide
(4)	helium	carbon dioxide	alcohol

4. The freezing points and the boiling points of 2 substances X and Y are shown in the table below.

Substance	Freezing point (°C)	Boiling point (°C)
X	8	80
Y	2	55

At which of the following temperature are both X and Y in their liquid state?

- | | |
|----------|----------|
| (1) 3°C | (2) 6°C |
| (3) 35°C | (4) 90°C |

5. Two beakers were each filled with different amount of water and heated with similar bunsen burners for a fixed period of time. The diagrams below show what was observed at the tenth minute of the experiment.

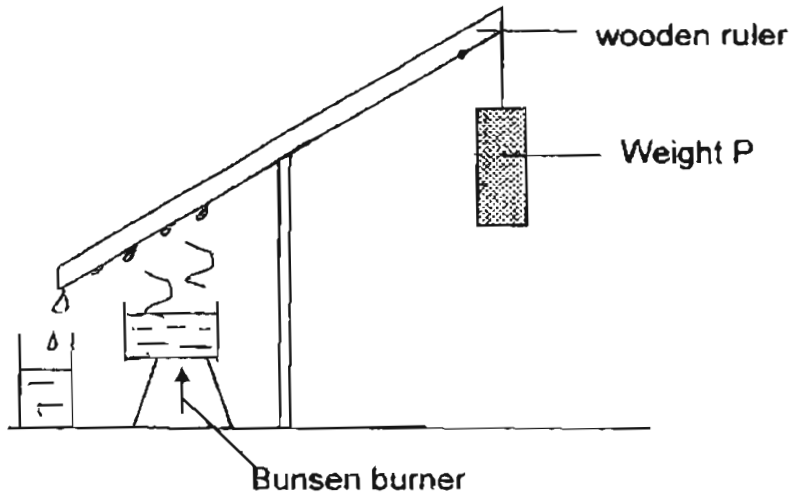

Set-up X

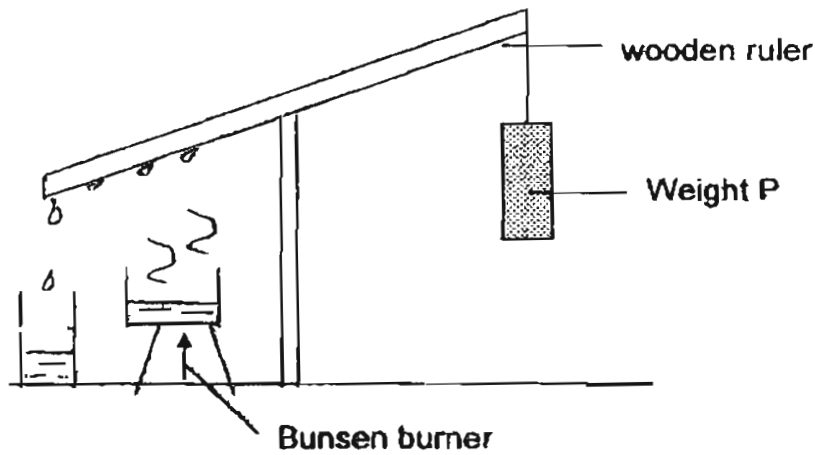

Set-up Y

Based only on the diagrams, which of the following statements is / are definitely true of the above set-ups at the tenth minute?

- A. The weight of the water droplets on the ruler in set-up X is greater than that in Y.
- B. The rate of condensation in set-up X is greater than that in set-up Y.
- C. The rate of evaporation is equal to the rate of condensation in each set-up.

- (1) A only
- (2) A and B only
- (3) B and C only
- (4) A, B and C only

()

6. Anand moulds a lump of plasticine into a big square block. He then cuts the plasticine into six equal pieces. Which one of the following is true about the total mass and volume of the six pieces of plasticine?

	Total Mass	Total Volume
(1)	increase	decrease
(2)	remain the same	increase
(3)	decrease	remain the same
(4)	remain the same	remain the same

7. Four identical beakers of tap water were heated to reach boiling point using different number of similar burners. Beakers A and B were each filled with 50 ml of water while beakers C and D were each filled with 150 ml of water.

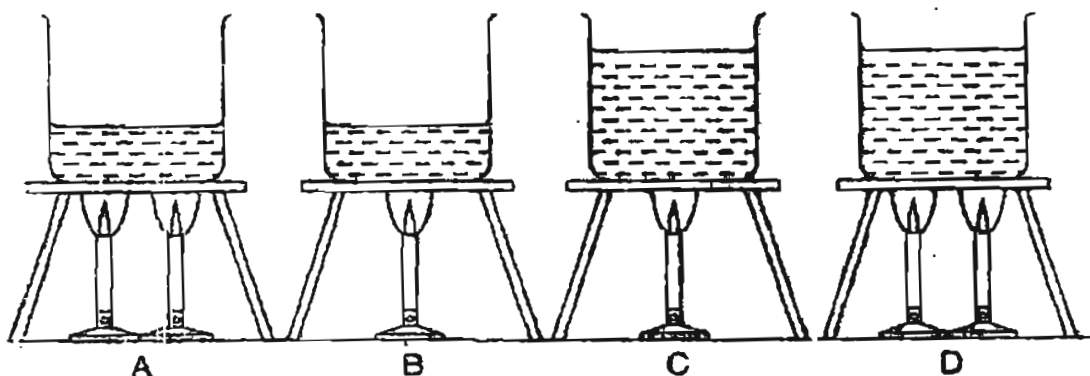

Which of the following shows the correct order for the time taken for the water in each beaker to boil, beginning with the shortest to the longest time?

- (1) A, B, C, D (2) A, B, D, C
 (3) C, D, B, A (4) D, A, B, C

8. The diagram below shows the water cycle.

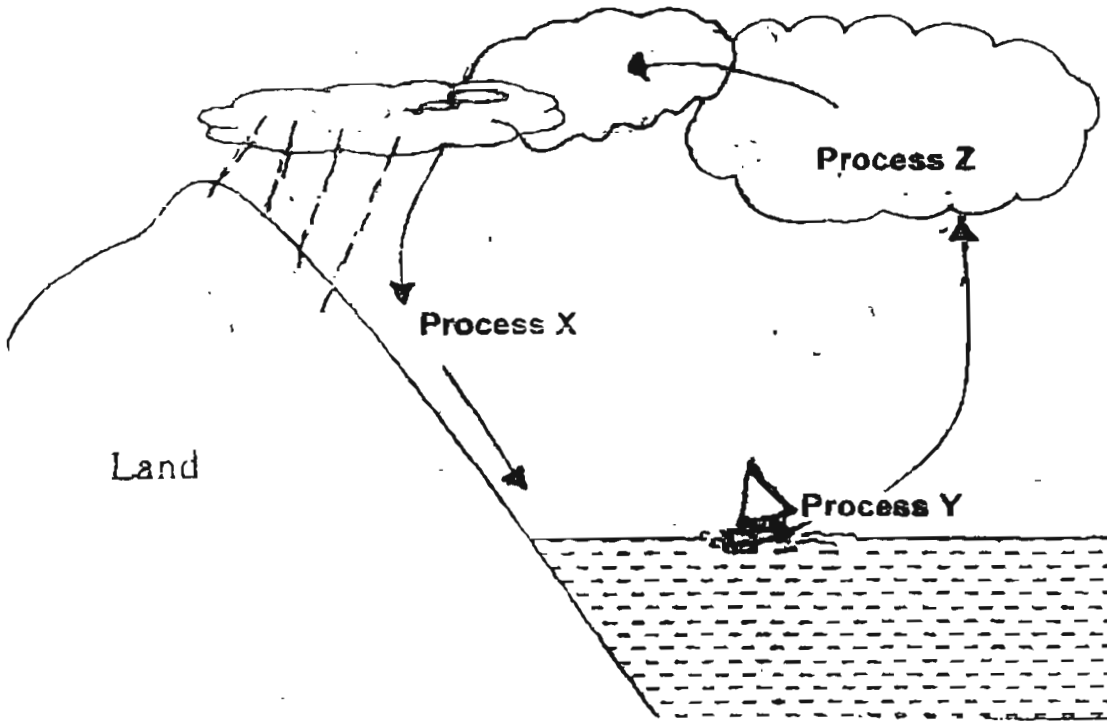

Which of the following statement(s) is/ are correct?

- A. Heat is lost during process Z only.
- B. Heat is gained during process Y only.
- C. The rate of process Z is increased with an increase in humidity.
- D. Water remains in the liquid state during process X and Y.

- (1) A only
- (3) A, B and C only

- (2) B and D only
- (4) A, B, C and D only

()

9. The picture below shows a river flowing downstream towards the sea. Situated near the river are a factory, a farm and a water treatment plant which supplies water for nearby homes.

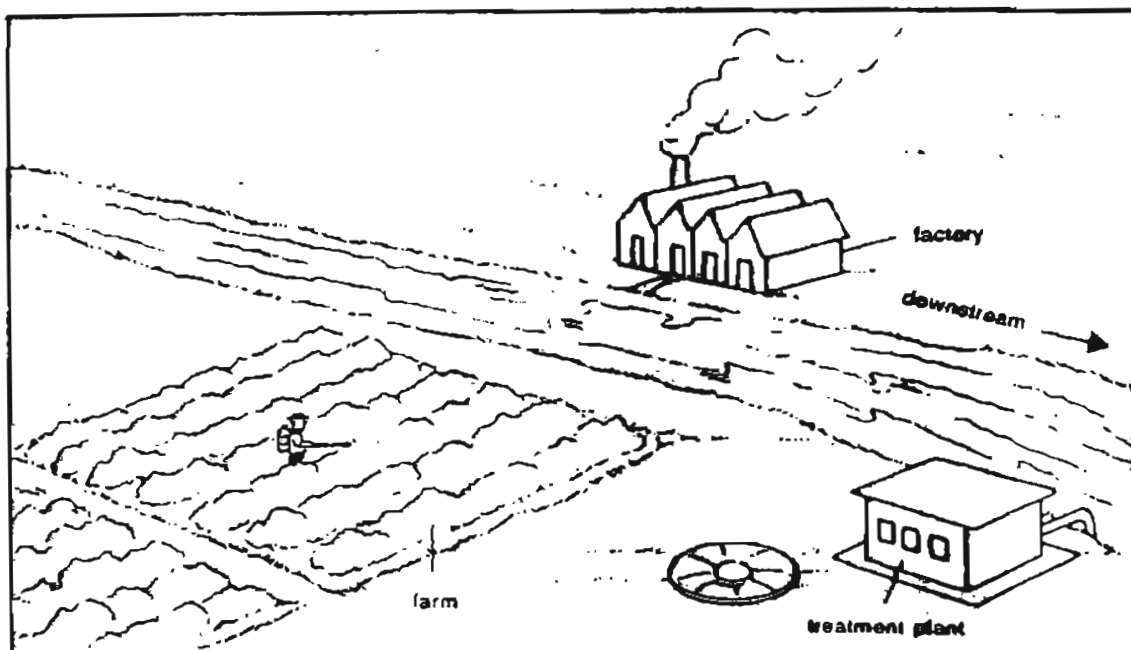

The water that is pumped to the homes was found to be contaminated. What was/were the likely source(s) of contamination?

- A. Pesticides used by the farmer.
- B. Fertilisers used by the farmer.
- C. Chemicals discharged by the factory.

- (1) A and B only
- (3) B and C only

- (2) A and C only
- (4) A, B and C only

()

10. Capillaries are tiny blood vessels that connect the _____ and _____.

- A. arteries
- B. veins
- C. heart
- D. other parts of the body

- (1) A and B only
- (3) B and C only

- (2) A and C only
- (4) C and D only

()

11. Ailing has a blood disorder called hemophilia which prevents her blood from clotting and sealing her wound when she cuts herself. This is because her blood lacks a blood clotting substance. Which one of the following is absent in Ailing's blood?

- | | |
|---------------|-----------------------|
| (1) plasma | (2) red blood cells |
| (3) platelets | (4) white blood cells |

()

12. Which of the following substances are carried in the blood?

- A. oxygen
- B. carbon dioxide
- C. digested food
- D. waste materials

- | | |
|---------------------|------------------------|
| (1) A and B only | (2) C and D only |
| (3) A, B and C only | (4) A, B, C and D only |

()

13. The following graph shows Mary's heart rate over a period of time.

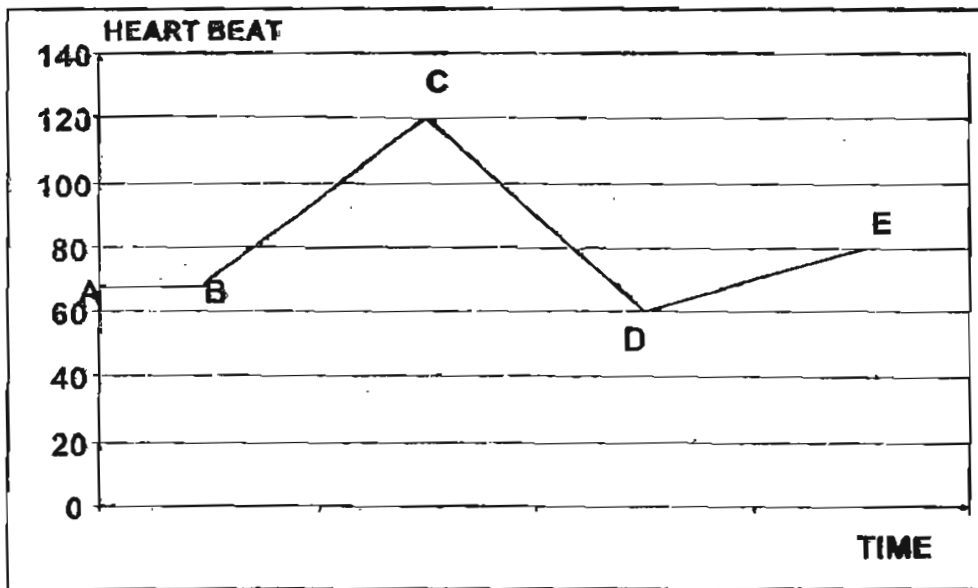

Which one of the following shows correctly Mary's activity and her heart rate?

- | | AB | BC | CD | DE |
|-----|----------|---------|----------|----------|
| (1) | sitting | running | sleeping | walking |
| (2) | sleeping | running | walking | sitting |
| (3) | sleeping | walking | running | sitting |
| (4) | walking | sitting | running | sleeping |

()

14. Which one of the diagrams correctly shows the direction in which blood flows in our body?

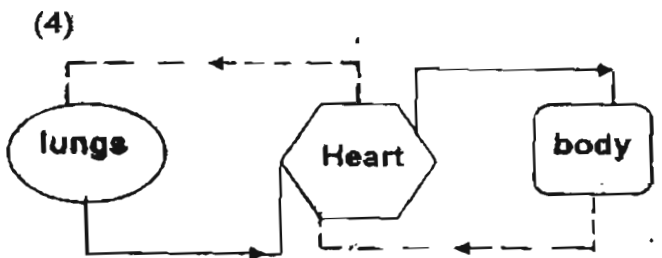
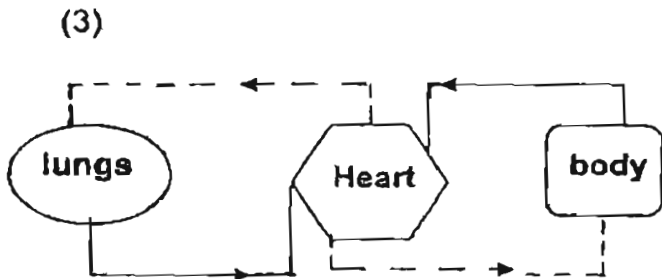
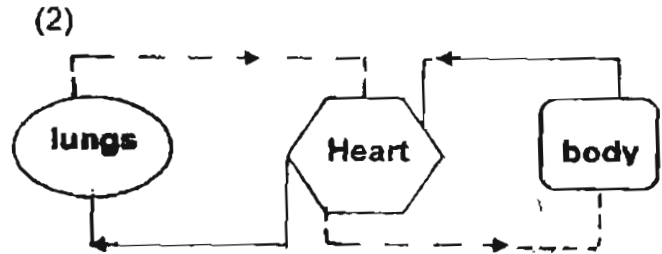
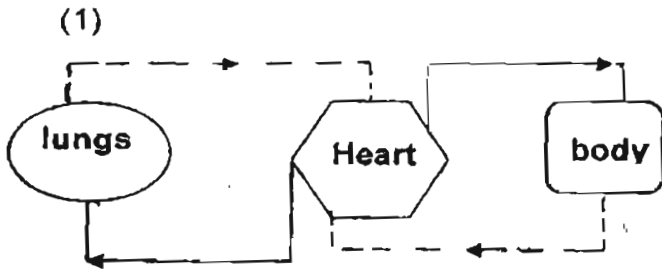
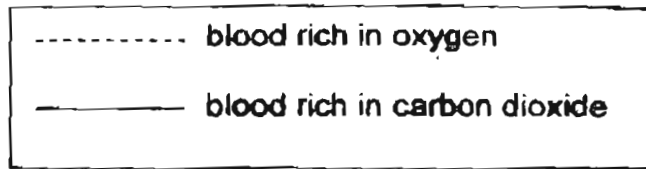

()

15. Study the diagram below.

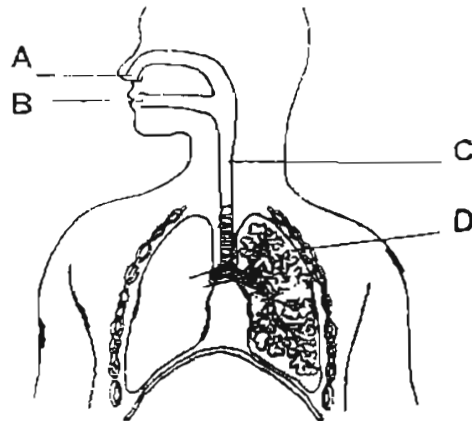

Which part A, B, C or D does gaseous exchange take place?

- (1) A
- (3) C

- (2) B
- (4) D

()

16. Sneezing is a natural body response to get rid of _____.

- (1) dust
- (3) cold air

- (2) phlegm
- (4) carbon dioxide

()

17. Which one of the following correctly describes our diaphragm and rib cage when we inhale?

Diaphragm

- (1) Becomes flatter
- (2) Becomes flatter
- (3) Becomes more domed
- (4) Becomes more domed

Rib cage

- Downwards and inwards
- Outwards and upwards
- Downwards and inwards
- Outwards and upwards

()

18. The pie chart below shows the composition of air we breathe in.

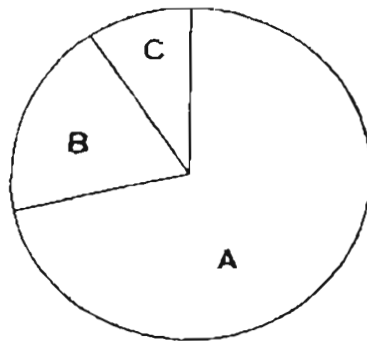

Which one of the following represents A, B and C?

	A	B	C
(1)	oxygen	nitrogen	carbon dioxide and other gases
(2)	carbon dioxide and other gases	nitrogen	oxygen
(3)	nitrogen	oxygen	carbon dioxide and other gases
(4)	nitrogen	carbon dioxide and other gases	oxygen

()

19. The diagram shows the human heart with its main blood vessels.

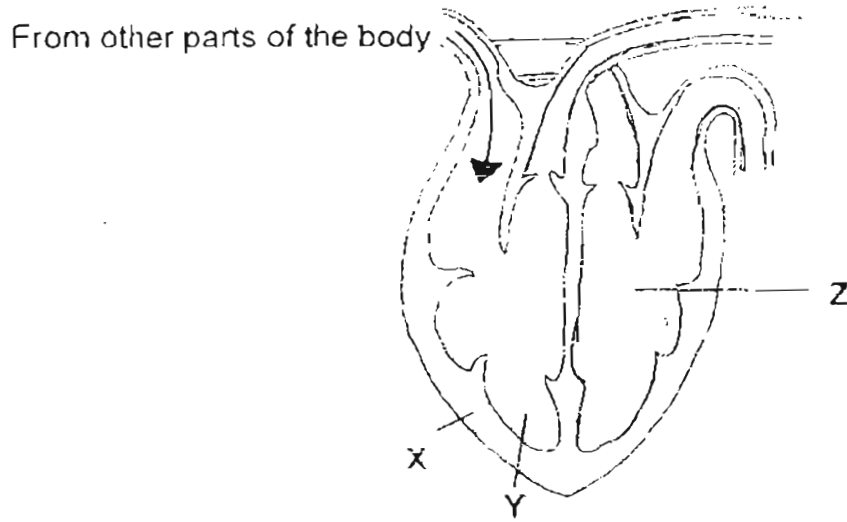

Which of the following statement(s) about the heart is / are true?

- A. Part X is made up of muscles.
- B. Part Y contains deoxygenated blood and Part Z contains oxygenated blood.
- C. Part Z contains both oxygenated blood and deoxygenated blood.

- (1) A only
- (3) A and B only

- (2) B only
- (4) A, B and C

()

20. Study the set up below.

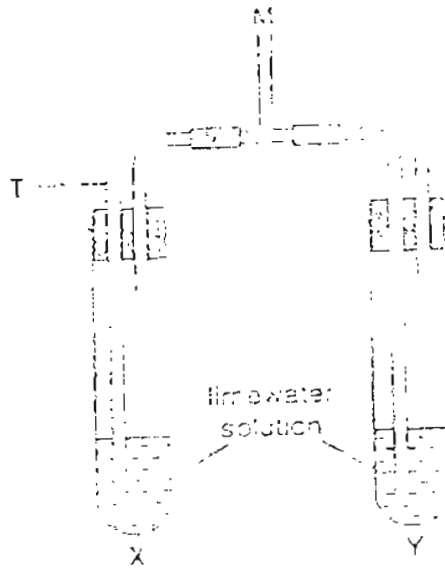

Which one of the following would be observed when Lily blew into tube M continuously for 30 seconds?

- (1) The solution in X and Y both turned cloudy.
- (2) The solution in X was forced out through the tube T
- (3) The solution in X remained clear, but that in Y turned chalky.
- (4) The solution in X turned cloudy, but that in Y remained clear.

()

21. Which one of the following best describes the path oxygen takes as it enters the body?

- (1) nose → mouth → windpipe → lungs
- (2) mouth → windpipe → lungs → air tubes
- (3) mouth → lungs → windpipe → air tubes
- (4) nose → windpipe → air tubes → lungs

()

22. Which one of the following diagrams correctly shows how iron nails are attracted to a magnet?

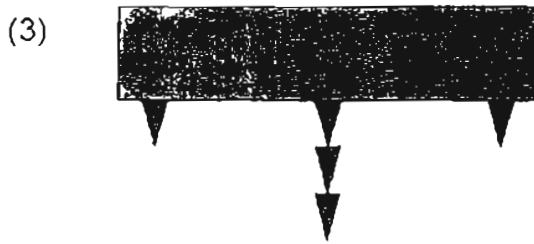

()

23. A long magnet is cut into two pieces as shown below. One of the pieces has the ends labelled as A and B and the other piece has the ends labelled as C and D. Which one of the following diagram shows the correct arrangement when you put the two magnets together?

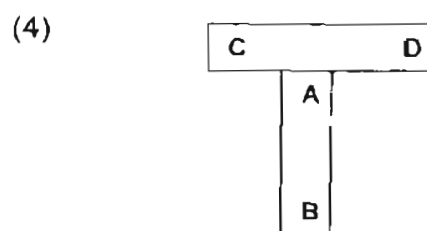
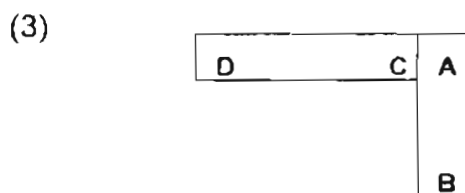
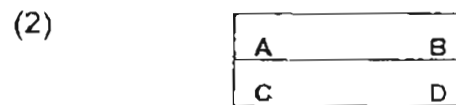
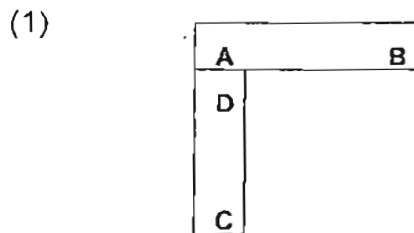
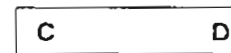

24. John had 4 iron bars A, B, C and D. He stroked them with a magnet according to the direction and its number of times shown in the following diagrams

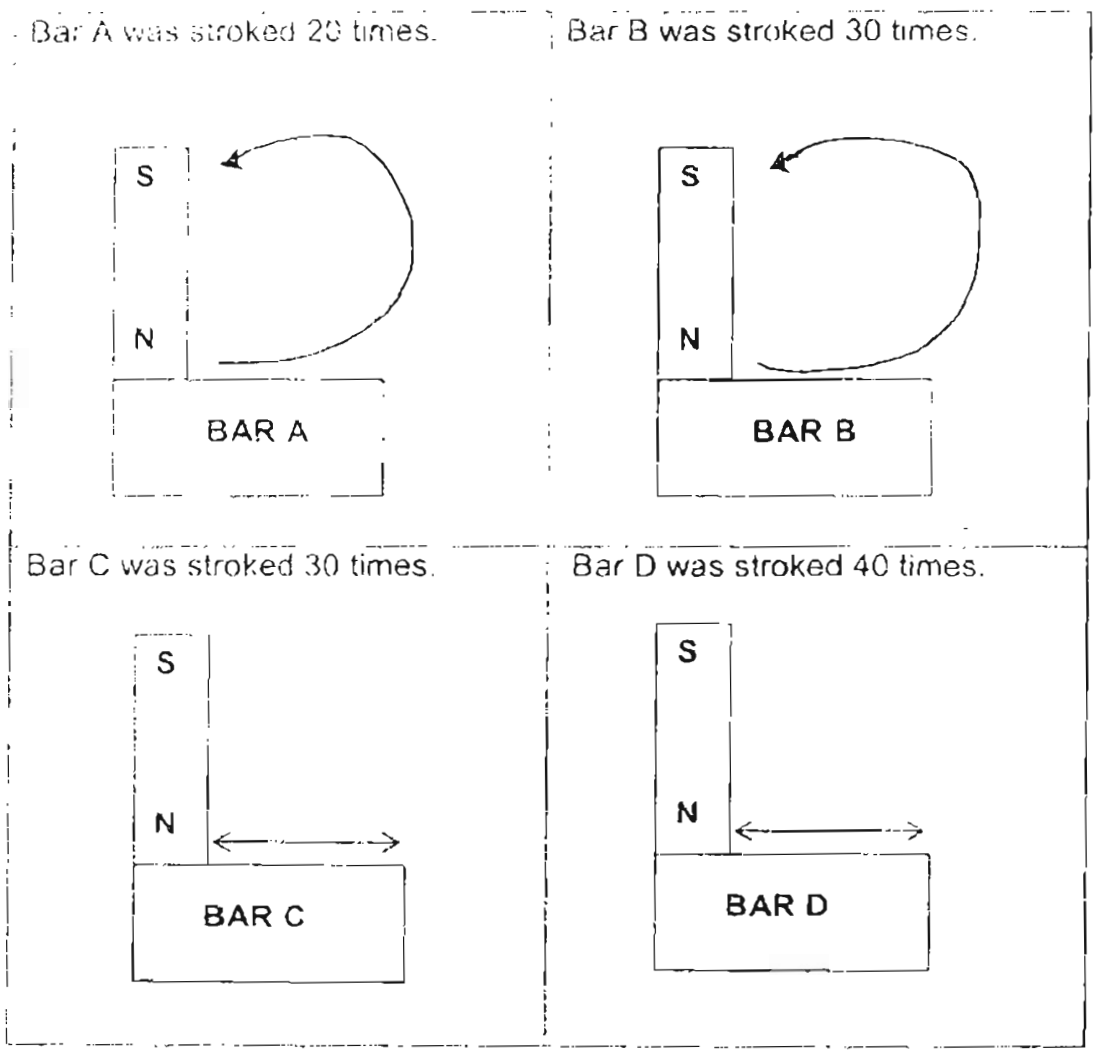

Which iron bar will become the strongest magnet?

- (1) A
- (3) C

- (2) B
- (4) D

()

25. When a freely hanging magnet is left suspended, which one of the following diagrams shows its correct position?

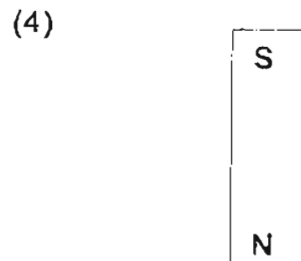
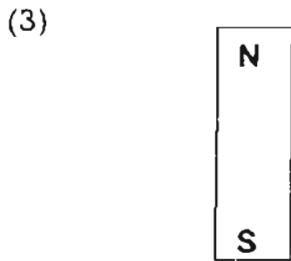
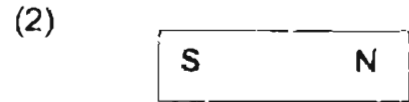
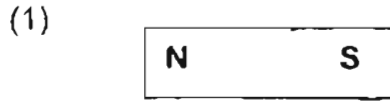

()

Name: _____

Date: 22nd Aug 05

Class: _____

Section B (30 marks)

Write your answers to questions 26 to 34 in the spaces provided.
Marks will be deducted for misspelt key words.

26. Peter put a sponge into a metal container as shown below. He then put weights on the plunger and measured the volume of the sponge when the plunger stopped moving downwards. He repeated the experiment with different weights.

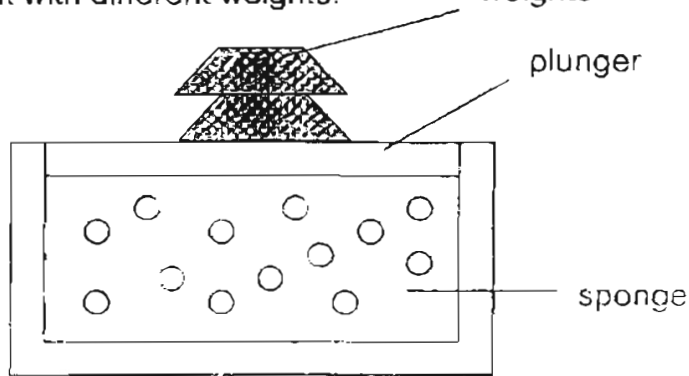

Peter recorded his results and drew a graph as shown below.

- (a) Label in the boxes below the horizontal axis and the vertical axis.

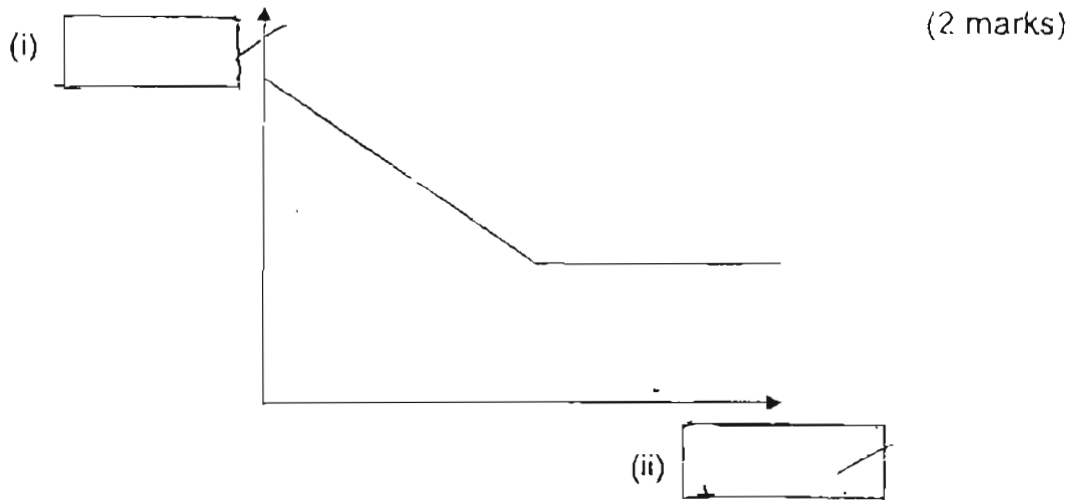

- (b) Name one property of the sponge based on the graph above
(1 mark)

27. Ziming conducted an experiment to investigate how different types of pollutants affected the growth of duckweeds. He filled 3 similar containers P, Q and R with tap water and then added 50 duckweeds into each of them. He added liquid detergent into container Q. He also added bleach into container R as shown in the table below. He then left the 3 containers near a window for 1 week.

- (a) Complete the table below with the correct amount of tap water and pollutants to be used to ensure a fair test. (2 marks)

Container	P	Q	R
Amount of tap water (ml)	100	100	100
Amount of pollutants (ml)	0	50	50

- (b) What should he measure in this experiment at the end of the week? (1 mark)

- (c) What is the purpose of having container P in the above experiment? (1 mark)

28. Tim used the apparatus below to make a model of our breathing system.

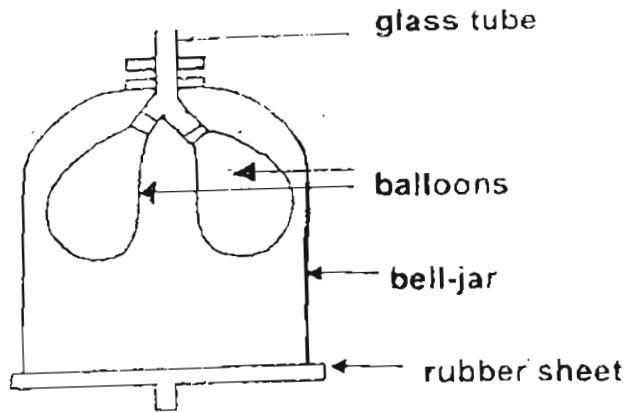

- (a) Describe what Tim should do if he wanted the balloons to inflate as much as possible. (1 mark)

- (b) The bell jar in the setup represents our rib cage whilst the rubber sheet represents our diaphragm.

- (i) How is the bell jar different from our rib cage during breathing? (1 mark)

- (ii) The rubber sheet above is different from our diaphragm when we exhale. Draw in the space below how each would look like when we exhale. (2 marks)

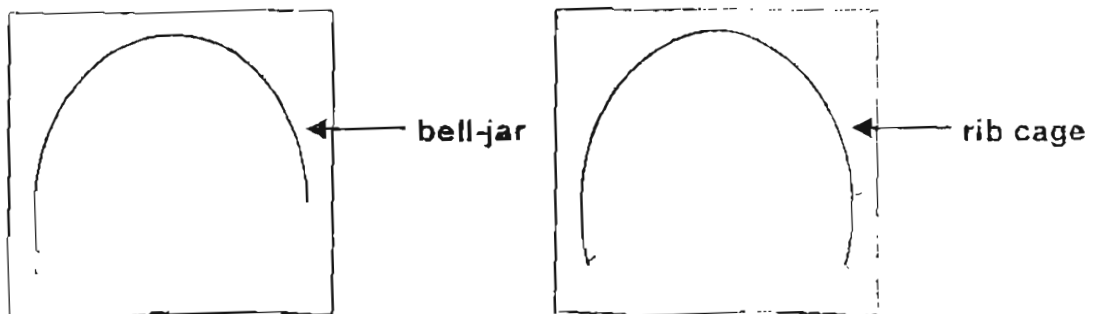

29. John carried out different activities for the same duration. These activities are represented by the letters A, B, C and D. He then measured his breathing rate and pulse rate for each activity. The results are recorded in the table shown below.

Activity	Pulse rate (no. of beats)	Breathing rate (no of times inhaled per minute)
A	65	30
B	75	35
C	110	50
D	135	65

- (a) What is the relationship between his pulse rate and his breathing rate? (1 mark)

- (b) Study activities A and D. Using the information above, compare and explain how John's heart reacted to these activities. (2 marks)

30. Harry did an experiment to compare inhaled and exhaled air. He noted down the differences in the table as shown below.

Inhaled air	Exhaled air
More oxygen	Less oxygen
Less warm	Warmer
Less carbon dioxide	More carbon dioxide
Less water vapour	More water vapour

Using the information given, indicate whether the statements below are 'True', 'False' or 'Not Possible to tell' by ticking the appropriate boxes.

(2 marks)

	Statements	True	False	Not Possible to tell
a.	The air we breathe out has no oxygen.			
b.	Exhaled air is heavier than inhaled air.			
c.	Inhaled air is not as damp as exhaled air.			
d.	The amount of air that is breathed in is the same as the amount of air breathed out.			

31. The table below shows a comparison between the human and plant circulatory systems. (2 marks)

(a) Complete the table below with suitable word(s)

	Human Circulatory System	Plant Circulatory System
Substance flowing in human circulatory and plant transport system	_____	Sap
Tubes through which substance flows	3 types (i). Arteries (ii) Capillaries (iii) Veins	2 types (i) _____ (ii) _____
Organ that pumps the substances through the tubes	Heart	None

(b) State the function of the 2 different types of tubes found in the plant circulatory system. (2 marks)

32(a)

Ali hung an iron ball from the ceiling. Next, he placed a thin glass sheet in the diagram as shown below.

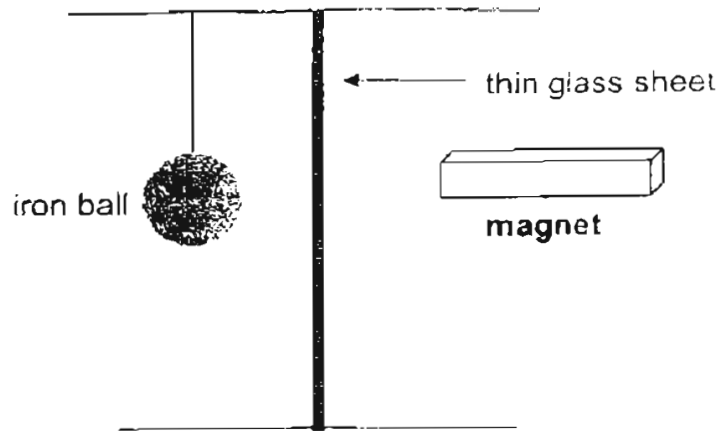

- (i) State an observation of the iron ball when a strong magnet shown in the diagram above is moved continuously to and fro without touching the glass sheet

- (ii) Explain your answer to (i). (1 mark)

(b) Ali then replaced the thin glass sheet with an iron sheet. Then he moved the magnet to and fro without touching the iron sheet.

(i) State an observation of the iron ball. (1 mark)

(ii) Based on the experiments in (a) and (b), what conclusion could he draw? (1 mark)

33. For each of the following items in the table below, write the correct property of magnets that makes each item useful. (2 marks)

Item	Use	Useful property of magnets for this use
Compass	To find direction	
Magnetic door holder	To prevent the door from closing	

34. Diagram 1 below shows two objects, labelled A and B hung on a balance.

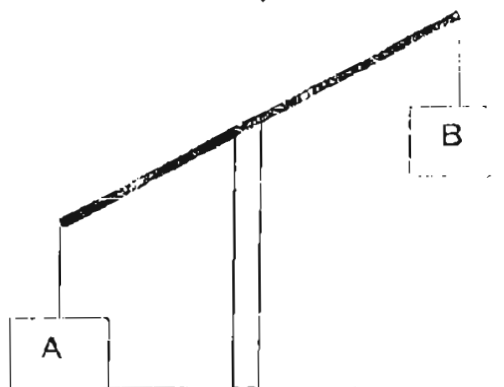

Diagram 1

Diagram 2 below shows what happens to objects A and B, after two other objects labelled C and D are placed on the table.



Diagram 2

- (a) Based on the above diagrams, put a tick in the right column for each of the following statements. (3 marks)

	True	False	Not possible to tell
(i) A is heavier than B.			
(ii) A and C are magnets.			
(iii) B is a magnet and D is a magnetic material.			



- (b) Explain your answer to (ii) (1 mark)

Nanyang Primary School
Primary 4 Science CA2 Exams (2005)

ExamSaver

Answer Sheets

Q1	Q2	Q3	Q4	Q5	Q6	Q7	Q8	Q9	Q10
3	3	2	3	2	4	2	3	4	1
Q11	Q12	Q13	Q14	Q15	Q16	Q17	Q18	Q19	Q20
3	4	1	2	4	1	2	3	3	3
Q21	Q22	Q23	Q24	Q25					
4	2	1	2	3					

- 26a. (i) Volume of sponge.
 (ii) No. of weights.
- 26b. The sponge can be compressed if there is a force.
- 27a. 50 altogether.
- 27b. He should measure how many duckweed were left.
- 27c. To confirm that the pollutants has caused the death of the duckweed.
- 28a. He pulled the rubber sheet down.
- 28b. (i) Our rib cage move outwards and upwards, but the bell jar stays stationary.
- (ii)  
- 29a. As breathing rate increases, the pulse rate will also increases.
- 29b. The heart is pumping faster in D than in A for the more vigorous activity D.
- 30a. False
- 30b. Not possible to tell
- 30c. True
- 30d. Not possible to tell.

- 31a. Blood
(i) Phloem
(ii) Xylem

31b. The xylem tube which is found on the inner side transports water from the roots to the leaves while the phloem tube which is found on the outer side transport food from the leaves to all the other parts of the plants.

- 32a. (i) The iron ball swings, oscillates moves to and fro left and right.
(ii) Magnetism can pass through the thin glass sheet and as it being moves away.

- 32b. (i) It will not move at all.
(ii) Magnetism cannot pass through glass not iron.

33a.

Useful property of magnets
Magnets come to rest in a north-south direction.
Magnets attract magnetic materials

- 34a. (i) True
(ii) True
(iii) Not possible to tell

34b. In diagram 1, A could go all the way down and touch the table. However in diagram 2, A and C were repelling as they could be like poles