



Anglo-Chinese School (Primary)

MID-YEAR EXAMINATION 2014  
SCIENCE  
PRIMARY FOUR  
BOOKLET A

Name: \_\_\_\_\_ (    )

Class: Primary 4 \_\_\_\_

Date: 8 May 2014

Duration of paper: 1 h 45 min

\_\_\_\_\_  
Parent's/Guardian's signature

**INSTRUCTION TO CANDIDATES.**

1. This question paper consist of 20 printed pages including this cover page.
2. Do not turn this page until you are told to do so.
3. Follow all instructions carefully.
4. Answer all questions.
5. Shade your answer on the Optical Answer Sheet (OAS) provided.

For each of the following questions from 1 to 30, four options are given. One of them is the correct answer. Make your choice (1, 2, 3 or 4). Shade the correct oval (1, 2, 3 or 4) on the Optical Answer Sheet. [60 marks]

---

- 1 Ethan used object P to scratch a block. A scratch mark could be seen on the block, as shown in the diagram below.

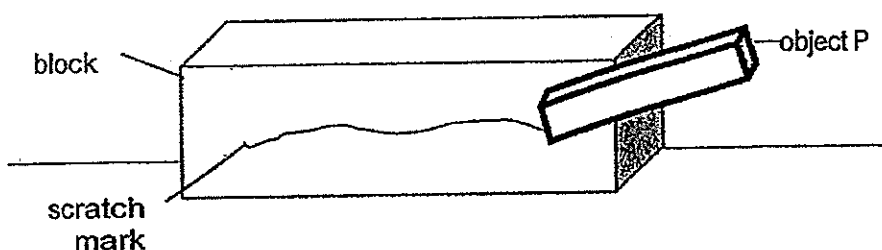

What can you conclude based on the above observation?

- (1) Object P is harder than the block
  - (2) The block is harder than object P.
  - (3) Object P is stronger than the block.
  - (4) The block is stronger than object P.
- 2 Which one of the following groups of organs forms the human respiratory system?
- (1) Nose, Mouth and Lungs
  - (2) Nose, Windpipe and Lungs
  - (3) Gullet, Windpipe and Lungs
  - (4) Mouth, Windpipe and Gullet

(Go on to the next page)

- 3 The flowchart below shows the characteristics of three materials, A, B and C.

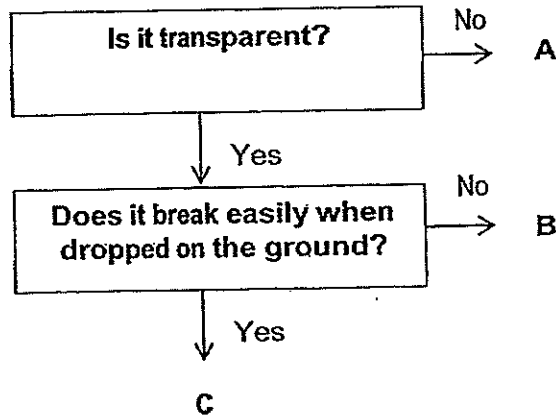

Which of the following could objects A, B and C be?

	A	B	C
(1)	Ceramic	Clear Glass	Clear Plastic
(2)	Wood	Clear Plastic	Clear Glass
(3)	Wood	Fabric	Clear Glass
(4)	Rubber	Metal	Clear Glass

- 4 Which one of the following is a characteristic of all living things?

- (1) It can make its own food.
- (2) It responds to changes.
- (3) It gives birth to live young.
- (4) It moves from place to place.

(Go on to the next page)

- 5 Kenneth wanted to test the strength of a magnet at various points, X, Y and Z, as shown in the diagram below.

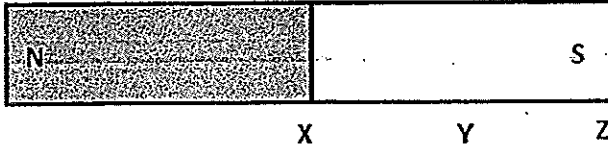

He then placed the magnet into a container full of paperclips.

Which one of the following bar graphs best represents the number of paperclips attracted to the magnet when it was taken out of the container?

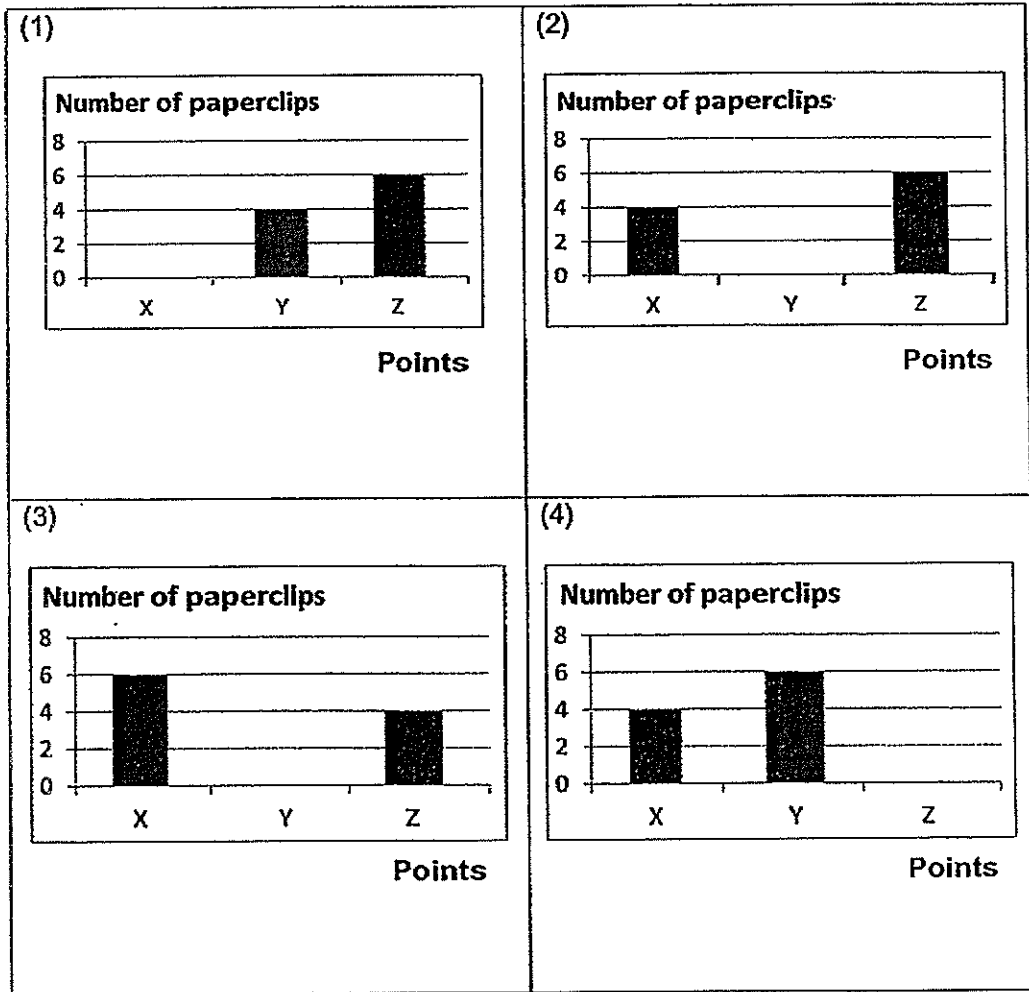

(Go on to the next page)

- 6 Joel carried out an experiment with four rods, D, E, F and G. He brought a bar magnet near to the ends of each rod and observed what happened.

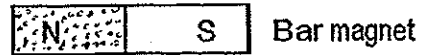
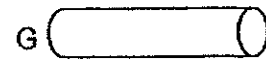
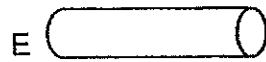

He recorded his observations in the table below.

Rod	Observations
D	Nothing happened when Rod D was brought near to the bar magnet.
E	Rod E was attracted by the S-pole of the bar magnet.
F	Rod F was repelled by the N-pole of the bar magnet.
G	Rod G was attracted by the N-pole of the bar magnet.

Which rod is definitely a magnet?

- (1) Rod D
- (2) Rod E
- (3) Rod F
- (4) Rod G

(Go on to the next page)

- 7 Study the classification chart below carefully.

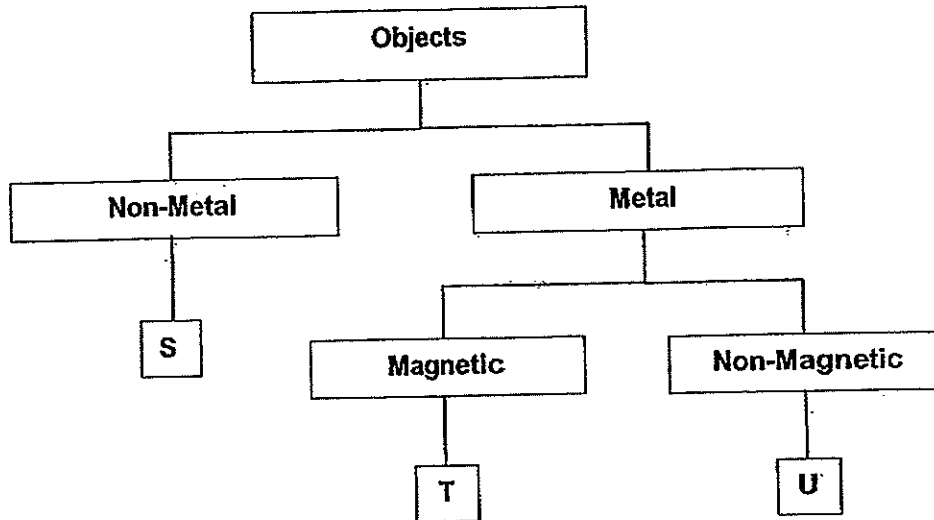

Which one of the following best represents objects S, T and U?

	S	T	U
(1)	Aluminium	Steel	Copper
(2)	Rubber	Cobalt	Copper
(3)	Plastic	Cobalt	Iron
(4)	Wood	Copper	Nickel

- 8 Which one of the following statements about the skeletal system is **not** correct?

- (1) It supports the body.
- (2) It gives the body shape.
- (3) It helps to break down food.
- (4) It protects the important organs in the body.

(Go on to the next page)

- 9 Study the flowchart below.

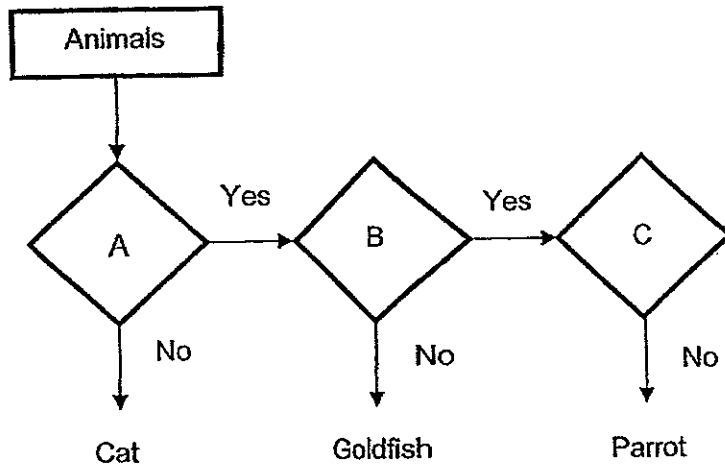

Which one of the following correctly represents A, B and C?

	A	B	C
(1)	Gives birth to live young?	Has two legs?	Has hairs?
(2)	Lays eggs?	Has two legs?	Has feathers?
(3)	Lays eggs?	Has a beak?	Has hairs?
(4)	Lays eggs?	Lives on land?	Has feathers?

- 10 An air-tight metal container was used to hold substance X. The table below shows the mass and volume of substance X in the container as more of it was added into the container.

Mass (g)	5	6	7	8	9
Volume (ml)	3000	3000	3000	3000	3000

Substance X is most likely to be \_\_\_\_\_.

- (1) sand
- (2) oxygen
- (3) plasticine
- (4) toothpaste

(Go on to the next page)

- 11 Study the diagram below carefully. The following buttons are classified into three different groups.

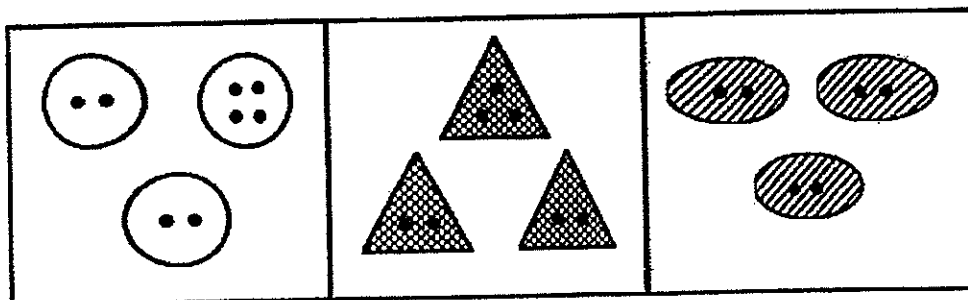

The above buttons are grouped according to their \_\_\_\_\_.

- A Shape
- B Patterns within the buttons
- C Number of holes within the buttons

- (1) A and B only
- (2) B and C only
- (3) A and C only
- (4) A, B and C

- 12 Which of the following characteristics show that a cat is a mammal?

- A It lives on land.
- B It has hairs on its body.
- C It responds to changes.
- D It feeds its young with milk.

- (1) A and B only
- (2) B and D only
- (3) C and D only
- (4) A, B and D only

(Go on to the next page)



- 13 Nigel classified the objects in his bag using the classification chart shown below.

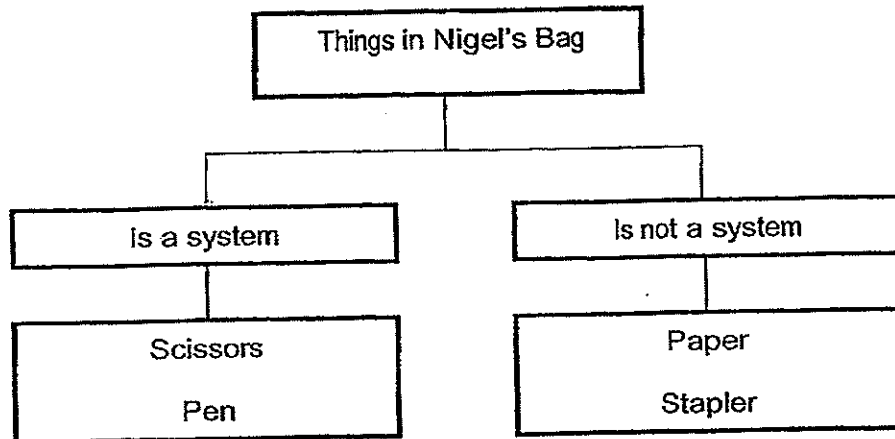

Which one of the following things has been classified wrongly?

- (1) Pen
  - (2) Paper
  - (3) Stapler
  - (4) Scissors
- 14 Robert pushed a balloon into a plastic bottle and stretched its mouthpiece over the opening of the bottle. Then he blew into the bottle but the balloon could not inflate fully as shown in the diagram below.

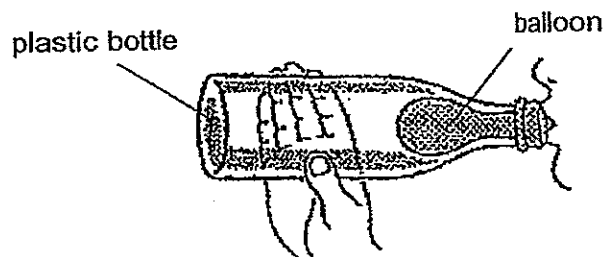

Which one of the following actions would allow the balloon to inflate more fully in the bottle?

- (1) Use a glass bottle.
- (2) Use a smaller balloon.
- (3) Make a hole in the balloon.
- (4) Make a hole in the plastic bottle.

(Go on to the next page)

- 15 The diagram below shows three cylinders of the same size but made of different materials.

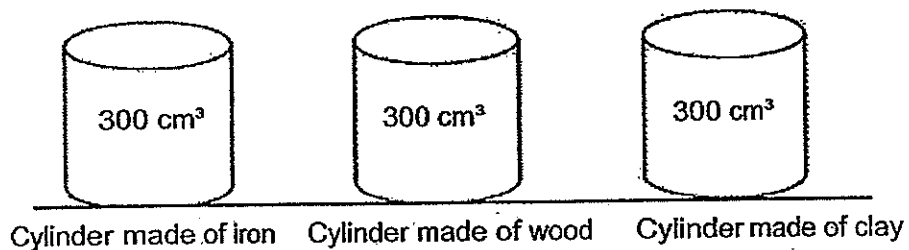

Which one of the following statements about the three cylinders is correct?

- (1) They all have equal mass.
  - (2) They all have the same volume.
  - (3) Only the clay and wooden cylinder have the same mass.
  - (4) The iron cylinder cannot be compressed but the wooden and clay cylinders can be compressed.
- 16 When a stone was lowered into the water in the displacement can as shown below, water was seen flowing into the beaker.

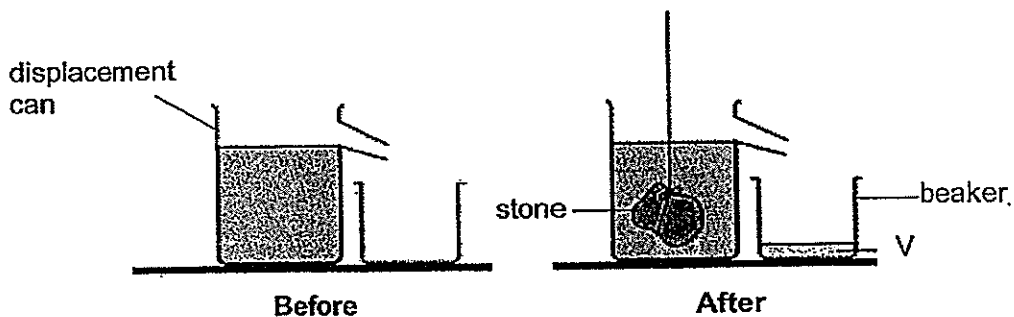

What does V represent?

- (1) Mass of the stone
- (2) Shape of the stone
- (3) Volume of the stone
- (4) The state of matter of the stone

(Go on to the next page)

- 17 The diagrams below show some apparatus used to measure the volume of liquids.

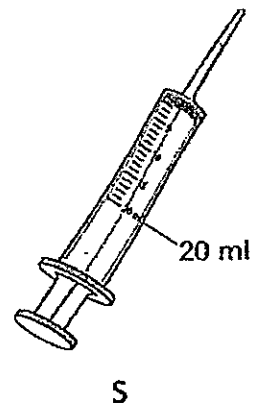
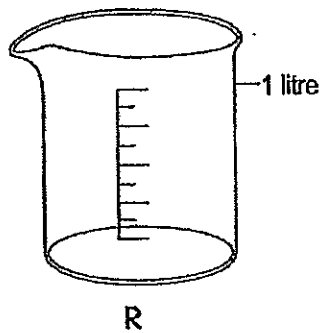
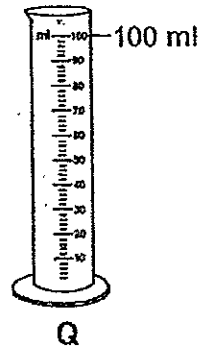
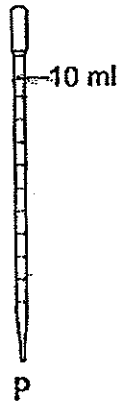

If each apparatus is to be used only once, which one of the following correctly arranges the above apparatus according to the maximum volume of liquid each apparatus can measure in **descending order**?

- (1) P, S, Q, R
- (2) R, Q, S, P
- (3) Q, P, R, S
- (4) S, R, P, Q

(Go on to the next page)

Refer to the flowchart below to answer Questions 18 to 20.

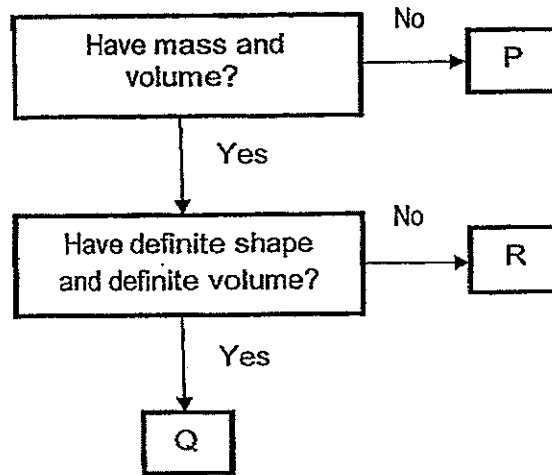

18 Which one of the following is likely to be P?

- (1) Rain
- (2) Heat
- (3) Stone
- (4) Oxygen

19 Which one of the following is likely to be Q?

- (1) Light
- (2) Alcohol
- (3) Steel rod
- (4) Carbon dioxide

(Go on to the next page)

20 Which of the following statements are true about R?

- A R is a gas.
- B R has mass.
- C R occupies space.
- D R has a definite shape.

- (1) A and B only
- (2) C and D only
- (3) A, B and C only
- (4) A, B, C and D

21 Which one of the following is **not** a source of heat energy?

- (1) The Sun
- (2) The Moon
- (3) A burning candle
- (4) A live human body

(Go on to the next page)

- 22 Study the diagram below carefully. Both containers are of the same size.

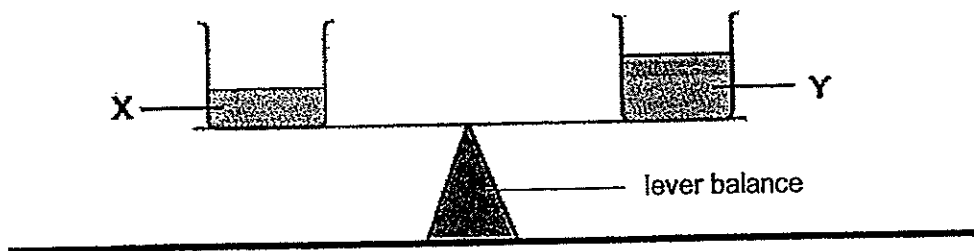

Which of the following are true about Liquid X and Liquid Y?

- A Liquid X and Liquid Y have the same mass.
  - B Liquid X has a smaller volume than Liquid Y.
  - C Liquid X occupies the same amount of space as Liquid Y.
  - D Liquid X can be compressed while Liquid Y cannot be compressed.
- (1) A and B only
- (2) B and C only
- (3) A, B and C only
- (4) A, B, C and D

(Go on to the next page)

- 23 A hole was made at the bottom of a plastic cup. The cup was then inverted and pushed vertically downwards into a basin of water as shown in the diagram below.

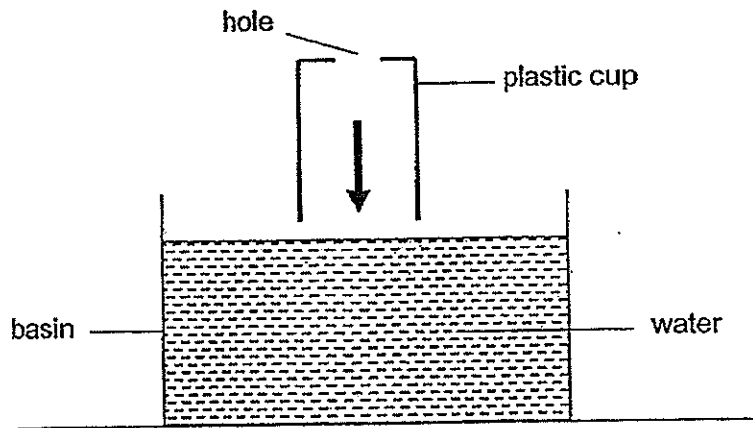

It was observed that the water level in the cup rose up and the water covered the cup entirely as shown below.

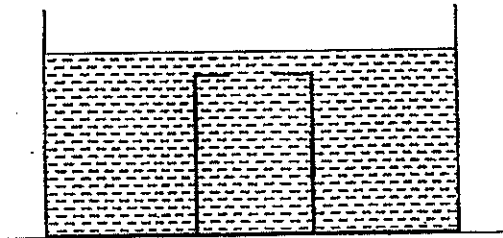

Which one of the following statements best explains the observation above?

- (1) Water has no definite shape, allowing the water to enter the cup and causing the water level to rise.
- (2) Water has a definite volume, allowing the water to enter the cup and causing the water level to rise.
- (3) The air inside the cup is compressed by the water and the cup, allowing the water to enter the cup and causing the water level to rise.
- (4) The air inside the cup escapes through the hole, allowing space for water to enter the cup and causing the water level to rise.

(Go on to the next page)

- 24 Dave wanted to launch his water rocket as shown in the diagram below.

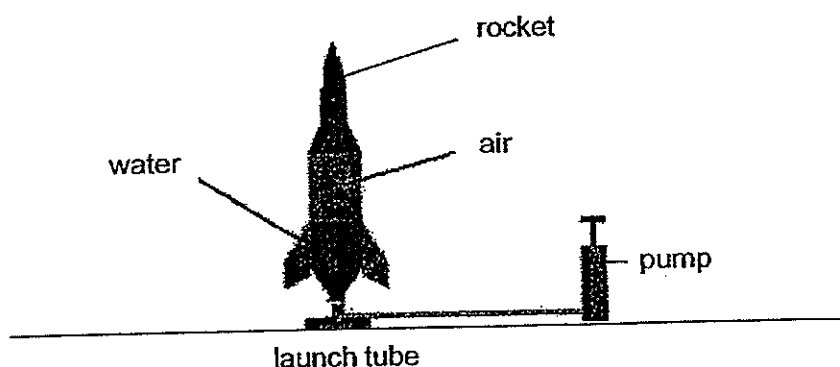

The distance a water rocket can fly depends on the amount of air pumped into the rocket. When more air is pumped in, the amount of air in the rocket increases.

Which one of the following properties of air best explains why Dave was able to pump in more air to increase the amount of air in his rocket?

- (1) Air has mass.
  - (2) Air takes up space.
  - (3) Air can be compressed.
  - (4) Air has no definite shape.
- 25 James had a cup of water. The volume of water was 100 ml and its temperature was 20°C.

Which one of the following actions would result in a loss of heat from the water?

- (1) Placing the cup of water under the sun.
- (2) Placing a hot spoon into the cup of water.
- (3) Placing the cup of water in a room at 32°C.
- (4) Placing the cup of water into the freezer compartment of a refrigerator.

(Go on to the next page)



- 26 The container of water was heated by the flame of a bunsen burner. *for 30 minutes*

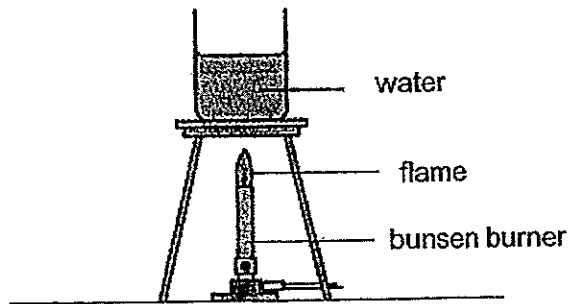

Which one of the following graphs shows the change in temperature of water over a period of 30 minutes?

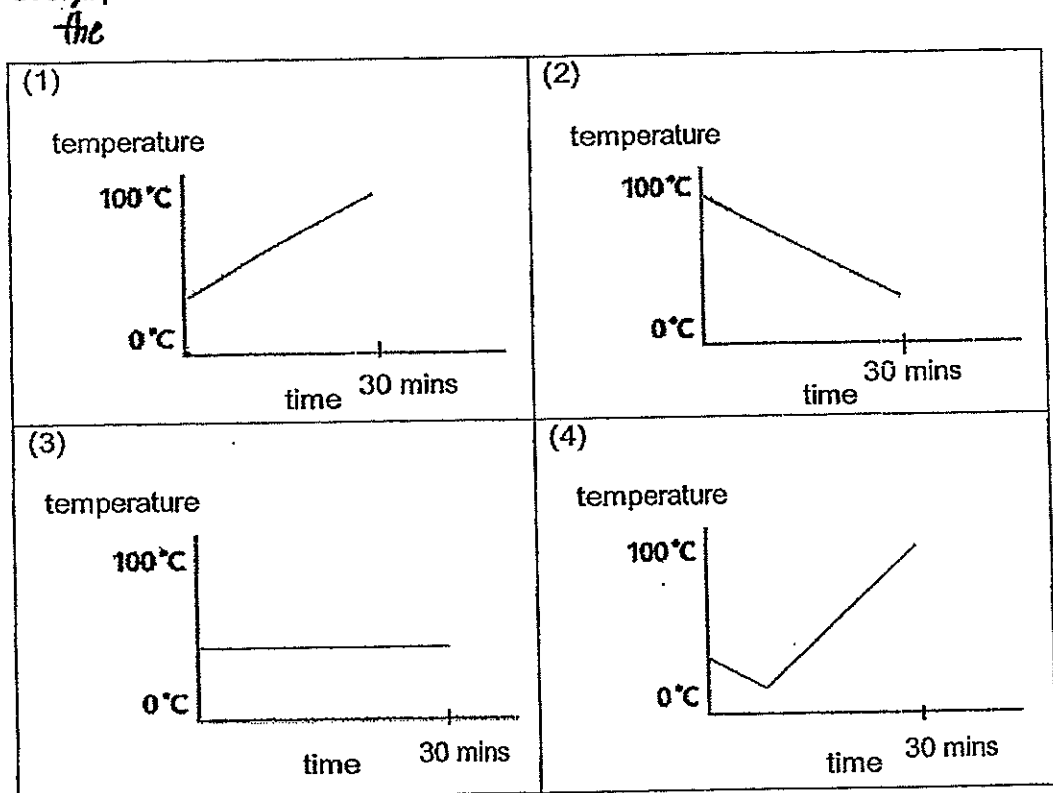

(Go on to the next page)

27 Which one of the following statements best describes temperature?

- (1) It is a form of matter.
- (2) It is a form of energy that makes things hot.
- (3) It can only be used to describe solids and liquids.
- (4) It is a measurement of the degree of hotness or coldness of an object.

28 Joe poured two identical liquids from Beakers P and Q into Beaker R, as shown in the diagram below. The volumes of both liquids were the same.

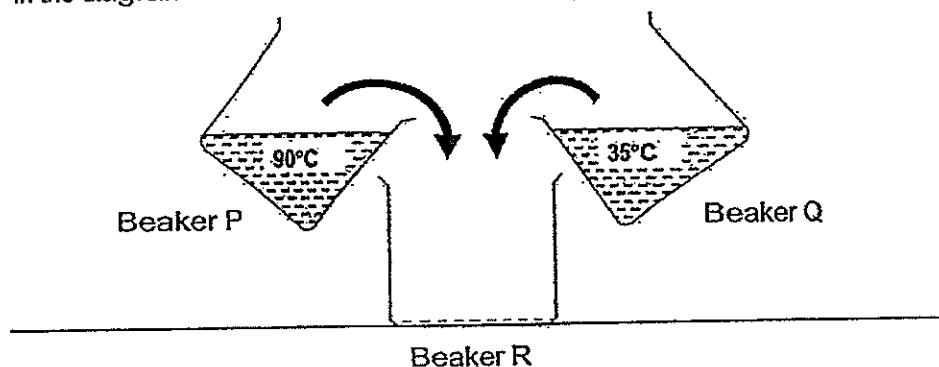

Which one of the following is most likely the temperature of the liquid in Beaker R?

- (1) 35°C
- (2) 60°C
- (3) 90°C
- (4) 125°C

(Go on to the next page)

- 29 An experiment was conducted using two identical beakers, X and Y. Beaker X was filled with marbles to the  $100\text{ cm}^3$  mark while Beaker Y was filled with water to the  $100\text{ cm}^3$  mark as shown in the diagram below.

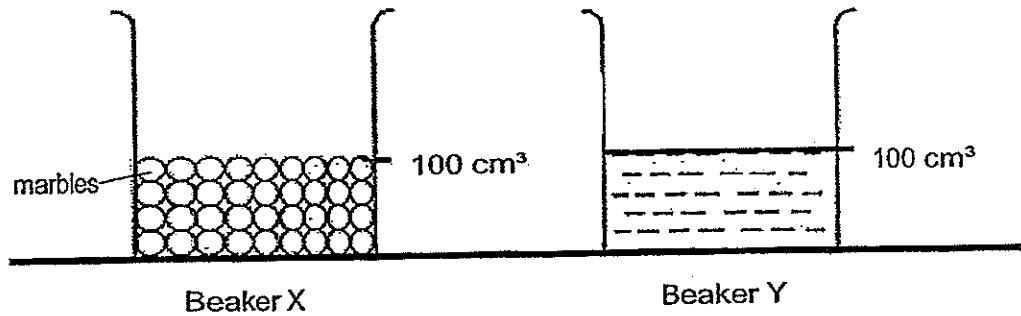

After pouring all the water from Beaker Y into Beaker X, it was observed that the new water level in Beaker X was more than  $100\text{ cm}^3$  but less than  $200\text{ cm}^3$ .

Which one of the following statements best explains the observation?

- (1) Water has a definite shape.
- (2) Water was compressed by the marbles in Beaker X.
- (3) The marbles in Beaker X absorbed some of the water.
- (4) Water filled the gaps between the marbles in Beaker X.

(Go on to the next page)

- 30 Faizal puts a metal spoon and some ice cubes into a beaker of hot water as shown in the diagram below.

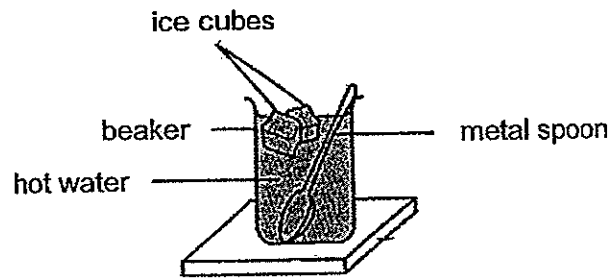

Which of the following will gain heat from the hot water?

- A beaker
  - B ice cubes
  - C metal spoon
- (1) A and B only
- (2) B and C only
- (3) C and A only
- (4) A, B and C

**END OF BOOKLET A**

Please go on to Booklet B



Anglo-Chinese School (Primary)

MID-YEAR EXAMINATION 2014  
SCIENCE  
PRIMARY FOUR  
BOOKLET B

Name: \_\_\_\_\_ ( )

Class: Primary 4 \_\_\_\_

Date: 8 May 2014

Duration of paper: 1 h 45 min

\_\_\_\_\_  
Parent's/Guardian's signature

**INSTRUCTIONS TO CANDIDATES**

1. This questions paper consists of <sup>13</sup> printed pages including this cover page.
2. Do not turn over this page until you are told to do so.
3. Follow all instructions carefully.
4. Answer all questions.
5. Write all your answers in this booklet.

Booklet	Maximum marks	Marks obtained
A	60	
B	40	
Total	100	

For questions 31 to 44, write your answers in the spaces provided in this booklet.

The number of marks available is shown in the brackets [ ] at the end of each question or part question. (40 marks)

31 The diagram below shows the human digestive system.

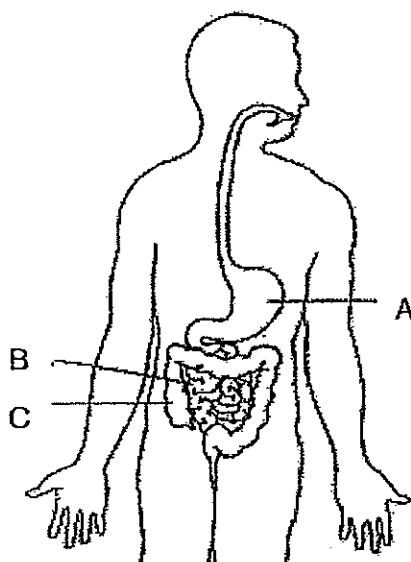

- (a) Based on the diagram above, identify the part (A, B or C) where
- (i) digestion is completed : \_\_\_\_\_ [1]
- (ii) water and dissolved mineral salts are absorbed : \_\_\_\_\_ [1]
- (b) How does chewing our food aid in the digestion of food? [1]

---



---

(Go on to the next page)

Score	3
-------	---

32 The picture below shows mushrooms growing on a piece of rotting log.

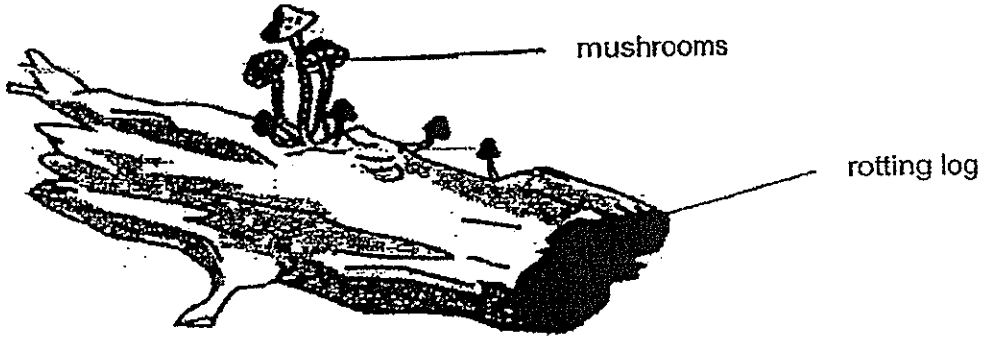

(a) Which group of organisms does mushrooms belong to? [1]

---

---

(b) How does the mushroom reproduce? [1]

---

---

(c) Why do the mushrooms grow on the piece of rotting log? [1]

---

---

(Go on to the next page)

Score	3
-------	---

33 Study the flowchart below:

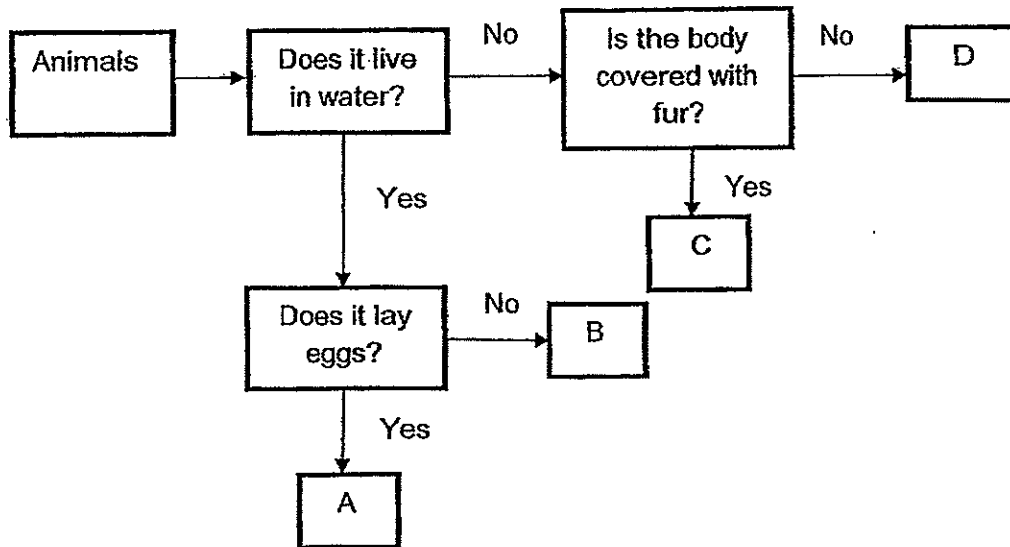

Based on the above flowchart,

(a) State one similarity between animal A and animal B. [1]

---



---

(b) State one difference between animal C and animal D. [1]

---



---

(Go on to the next page)

Score	2
-------	---



34 Study the picture shown below.

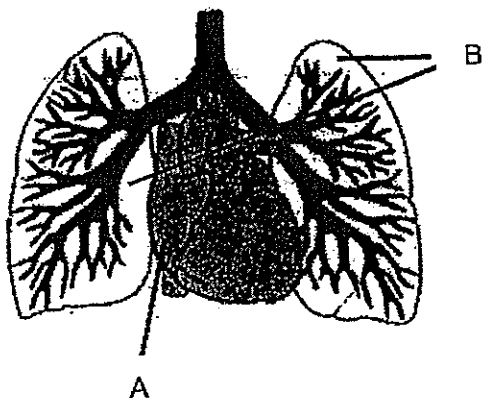

(a) Identify the organs labelled:

A: \_\_\_\_\_ [1]

B: \_\_\_\_\_ [1]

(b) State two functions of the respiratory system. [2]

\_\_\_\_\_

\_\_\_\_\_

35 Put a tick (✓) in the appropriate boxes to indicate if each statement is true or false. [2]

Statement	True	False
All matter can be seen.		
All matter can be compressed.		
An object that floats does not have mass.		
Volume is the amount of space an object occupies.		

(Go on to the next page)

Score	6
-------	---

36 The diagram shows a plant.

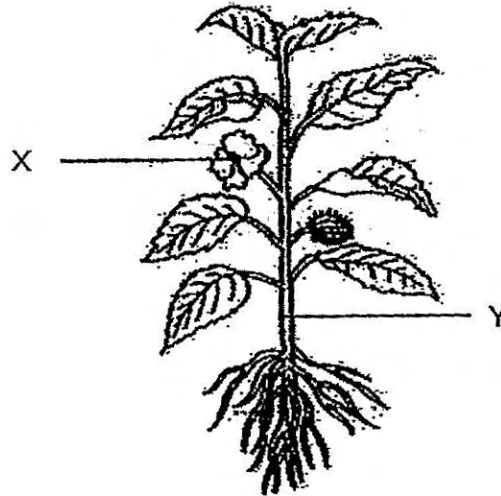

(a) Name plant part X.

[1]

---



---



(b) What would happen to the plant when part Y is damaged by strong wind as shown above? Explain your answer.

[2]

---



---

(Go on to the next page)

Score	3
-------	---

- 37 A measuring cylinder and a jug of water as show in the diagram below can be used to find the volume of a rock.

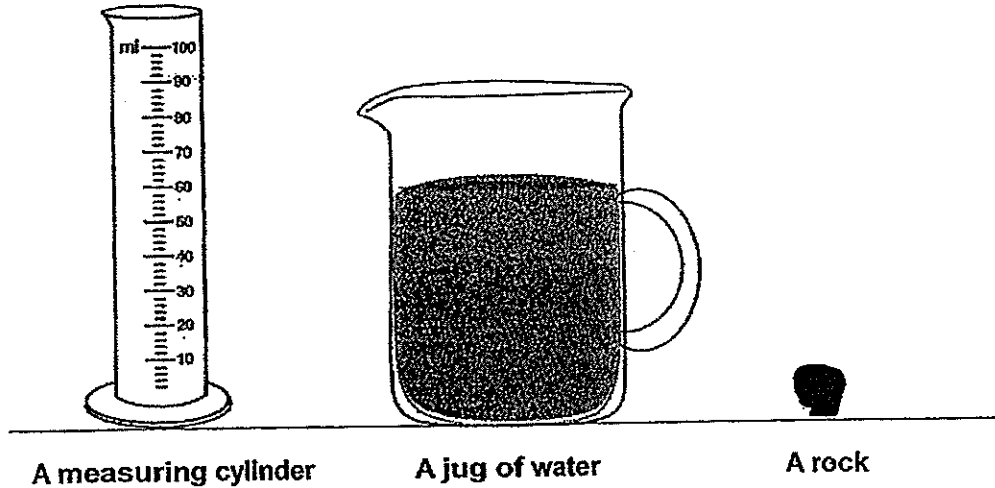

Arrange the following steps in order to describe the correct procedure to find the volume of the rock, by indicating 1, 2, 3 and 4. [2]

- (a) Lower the rock gently into the measuring cylinder of water, making sure that the rock is completely underwater. \_\_\_\_\_
- (b) Record the volume of water in the measuring cylinder at the beginning. \_\_\_\_\_
- (c) Pour some water into the measuring cylinder. \_\_\_\_\_
- (d) Record the new volume of water. Then, subtract from it, the volume of water that was in the measuring cylinder at the beginning. \_\_\_\_\_

(Go on to the next page)

Score	2
-------	---

- 38 Three syringes, A, B and C, were filled with different substances as shown in the diagrams below. The nozzles were blocked by a finger each.

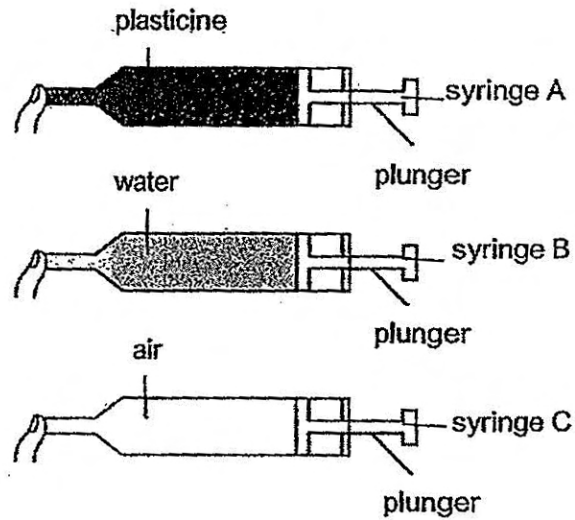

- (a) In which of the syringe(s), A, B or C, can the plunger(s) be pushed in ~~completely?~~ <sup>the most</sup> [1]
- \_\_\_\_\_
- (b) Explain your answer in (a), by comparing the properties of matter in all three syringes, A, B and C. [2]
- \_\_\_\_\_
- \_\_\_\_\_
- \_\_\_\_\_

(Go on to the next page)

Score	3
-------	---

39 Deming used a measuring cylinder and a beaker of water to measure the volume of a ball of plasticine. After that, he flattened the plasticine, ensuring its mass remained the same. He then measured the volume of the flattened plasticine.

(a) What property of the plasticine has been changed in Deming's experiment? [1]

\_\_\_\_\_

(b) What is the aim of Deming's experiment? [1]

\_\_\_\_\_

\_\_\_\_\_

(c) What would happen to the volume of the flattened plasticine? [1]

\_\_\_\_\_

40 Ashley wanted to magnetize an iron nail. He took an electrical wire and coiled it round an iron nail. He then connected the ends of the wire to a battery as shown below. The iron nail became a magnet and was able to attract some paper clips.

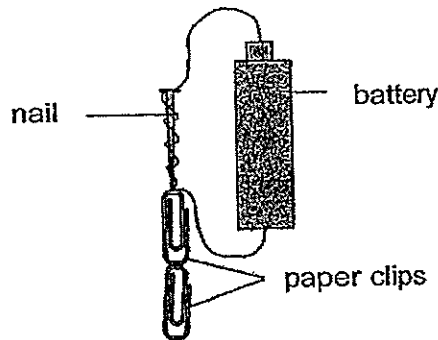

(a) What would Ashley observe if the battery was removed from the above set-up? [1]

\_\_\_\_\_

\_\_\_\_\_

(b) Suggest two changes that Ashley can do to the above set-up to make it attract more paper clips. [2]

(i) \_\_\_\_\_

(ii) \_\_\_\_\_

(Go on to the next page)

Score	6
-------	---

- 41 Fatimah wanted to find out how the temperature of water affects the time taken for sugar to dissolve.

- (a) Which of the following variables should she keep the same for her experiment to be a fair one?

Place a tick ( ✓ ) in the table below for the variable(s) that should be kept the same. [2]

Variables	Keep the same
Type of sugar	
Amount of sugar	
Amount of water	
Temperature of water used in the experiment	

She carried out her investigation three times and recorded her results as shown in the table below.

Temperature of water (°C)	Time taken for the sugar to dissolve (minutes)		
	Test 1	Test 2	Test 3
30	5	6	5
40	4	3	3
50	1	1	2

- (b) Based on the results in the table above, what can Fatimah conclude from the above experiment? [1]

---



---

(Go on to the next page)

Score	3
-------	---

42 Suri wanted to find out how long it will take to heat three identical pots of water as shown in the diagram below, to reach a temperature of 50 °C.

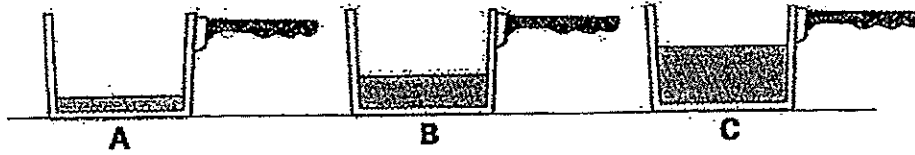

(a) What is the changed variable in Suri's experiment? [1]

\_\_\_\_\_

(b) What measuring instrument should Suri use to measure the temperature of the water safely and accurately? [1]

\_\_\_\_\_

The graph below shows how the water temperature changed in each pot.

Temperature (°C) of the pots of water

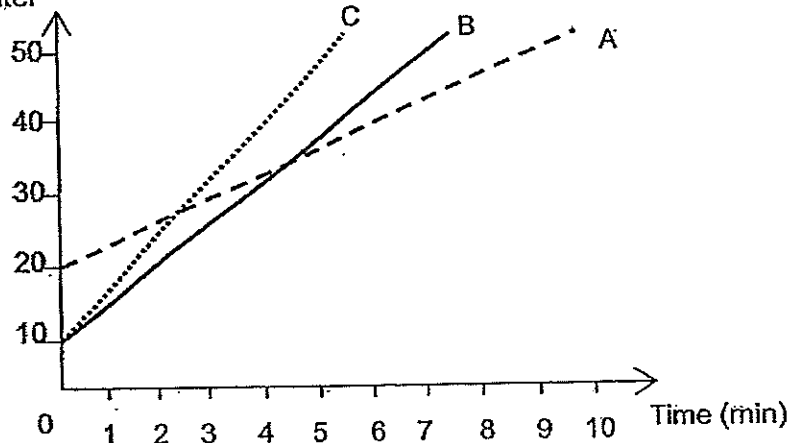

(c) Based on the graph above, explain why Suri's test was not a fair one. [1]

\_\_\_\_\_

\_\_\_\_\_

(Go on to the next page)

Score	3
-------	---

- 43 Muthu balanced two similar glass containers, P and Q, each containing 200 ml of water on a balance as shown in the diagram below. The maximum volume each container can hold is  $300 \text{ cm}^3$ . Each container had a one-way valve that allowed air to be pumped in but did not allow air to escape.

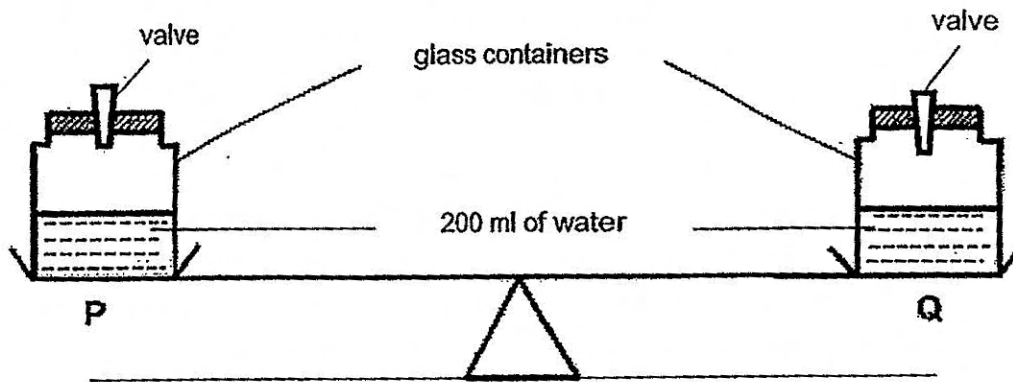

Muthu pumped in an additional  $50 \text{ cm}^3$  of air into Container P but did not do anything to Container Q.

- (a) Predict if the balance will tilt towards the left, right, or remain balanced. [1]

\_\_\_\_\_

- (b) Explain your answer in (a). [1]

\_\_\_\_\_  
\_\_\_\_\_

- (c) What will the volume of air in P and Q be at the end of the experiment? [1]

\_\_\_\_\_

(Go on to the next page)

Score	/
	3



- 44 Michael had a chocolate bar which had fruits and nuts in it. He wanted to separate the fruits and nuts from the chocolate. He put the chocolate bar into a container and heated it.

(a) State the change of state that happened when Michael heated the chocolate bar. [1]

---

(b) Explain how the change in state identified in (a) happened. [1]

---

---

After heating, Michael immediately used a sieve as shown below to separate the chocolate from the fruits and nuts by pouring the chocolate mixture into it and collecting the chocolate in another container.

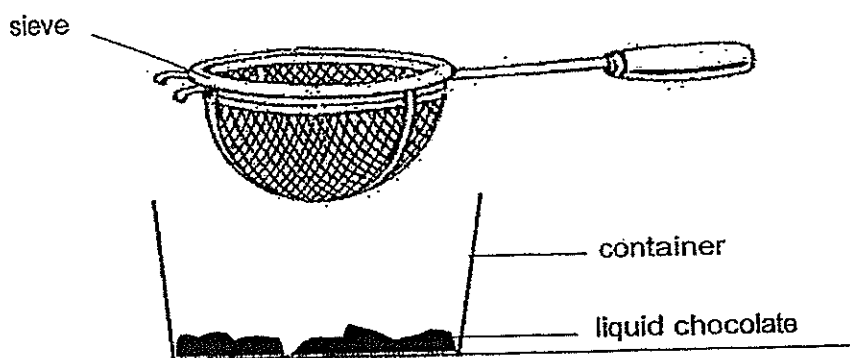

(c) State the property of the liquid chocolate that allowed it to flow through the sieve. [1]

---

**END OF BOOKLET B**

Please check all your answers carefully

Score	3
-------	---



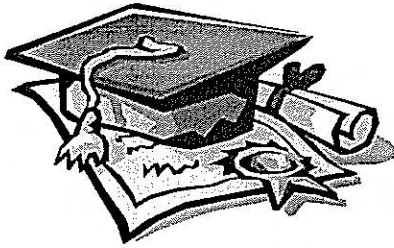

# ANSWER SHEET

**EXAM PAPER 2014**

**SCHOOL : ACS**

**PRIMARY : P4**

**SUBJECT : SCIENCE**

**TERM : SA1**

---

Q1	Q2	Q3	Q4	Q5	Q6	Q7	Q8	Q9	Q10	Q11	Q12	Q13	Q14	Q15	Q16	Q17
1	2	2	2	1	3	2	3	3	2	1	2	3	4	2	3	2

Q18	Q19	Q20	Q21	Q22	Q23	Q24	Q25	Q26	Q27	Q28	Q29	Q30
2	3	3	2	1	4	3	4	1	4	2	4	4

31)a)i)B ii)C

b)Chewing helps grind break the food into smaller picas.

32)a)fungi

b)By spores

c)They absorb nutrients from the rotting log.

33)a)Both animal lived in water.

b)Animal C is covered with fur but animal D is not.

34)a)A: Heart B: lungs

b)The respiratory system helps us to breathe and protects the heart.

35)F, F, F, T

36)a)Flower.

b)It will die water taken in by the roots cannot reach the other parts of the plant and food made by the leaves cannot reach the others parts of the plant.

- 37)a)3  
b)2  
c)1  
d)4

38)a)Syringe C.

b)Plasticine and water cannot be compress as solid and liquid have definite volume, while air can be compress as gas does not have definite volume.

39)a)The shape of the plasticine has been change.

b)The aim was to find out if he flattened it, the volume or the mass will change.

c)The volume will remain the same.

40)a)He will observe that the iron nail will not attract any more paper clips.

b)i)He should put in more batteries.

ii)He should coiled the wire a few more times.

41)a)type of sugar

Amount of sugar

Amount of water

b)The higher the temperature of the water the taster the sugar dissolves.

42)a)The water level.

b)The thermometer.

c)The temperature of the water in the 3 part are different at the start of the experiment.

43)a)To the left.

b)There is an increase in air in P. As air has mass, pull increase in mass.

c)100cm<sup>3</sup> for each container.

44)a)The chocolate bar will melt.

b)Heat was gained by the chocolate bar.

c)Liquid chocolate has no definite shape.