

TAO NAN SCHOOL

PRIMARY 4 SCIENCE END-OF-YEAR EXAMINATION – 2010

Name : _____ ()

Date : 1 November 2010

Class : P4 _____

Time : 8.00 a.m. to 9.30 a.m.

Booklet A

INSTRUCTIONS TO CANDIDATES

Do not open this booklet until you are told to do so.

Follow all instructions carefully.

Answer all questions.

	Score	Marks
Section A		60

Section A (30 x 2 marks)

For each question, 1 to 30, four options are given. One of them is the correct answer. Shade the correct oval (1, 2, 3 or 4) on the Optical Answer Sheet.

1. Anna can easily scratch a plastic rod with a needle as shown in the drawing below.

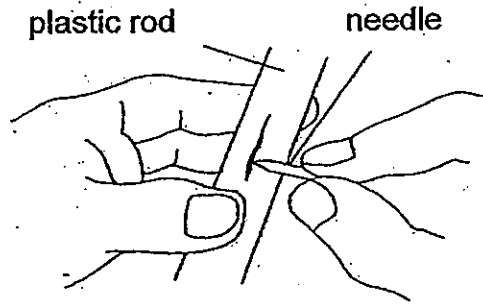

This shows that the needle is _____ than the plastic rod.

- (1) harder
- (2) darker
- (3) heavier
- (4) stronger

2. The diagram below shows the growth of a young plant with two missing stages, P and Q.

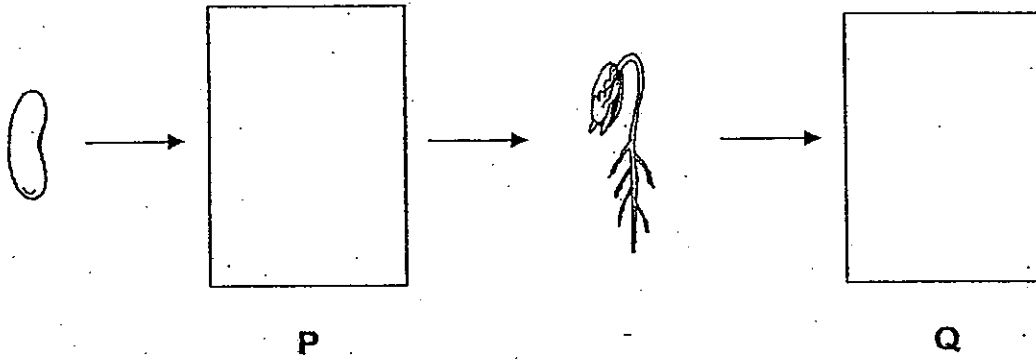

Which of the following shows the stages, P and Q?

	P	Q
(1)		
(2)		
(3)		
(4)		

3. The table below shows how some living things can be grouped.

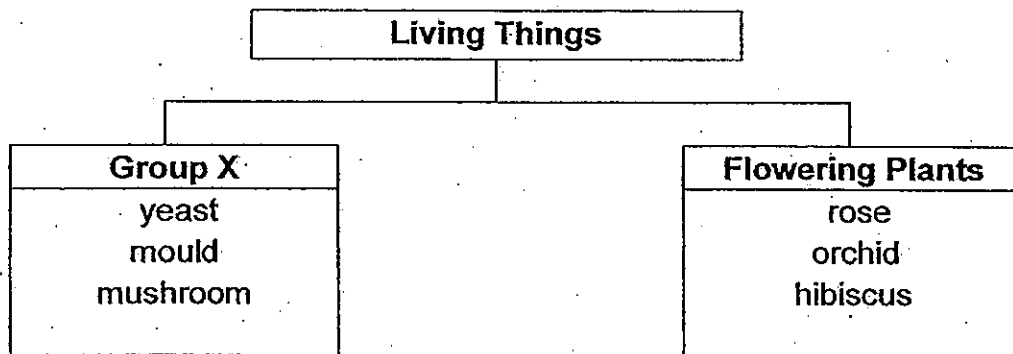

What is Group X?

- (1) Ferns
- (2) Fungi
- (3) Bacteria
- (4) Non-flowering plants

4. What is the function of a stem of a tree?

- (1) It helps the plant to reproduce.
- (2) It takes in water and mineral salts.
- (3) It makes food in the presence of light.
- (4) It holds the leaves up to obtain sunlight.

5. What is the function of the small intestine?

- (1) It transports digested food to the stomach.
- (2) It removes undigested food from the body.
- (3) It absorbs water from the undigested food.
- (4) It absorbs digested food into the bloodstream.

6. Brenda poured boiling water into four similar cups. Which cup of boiling water would cool down to room temperature first?

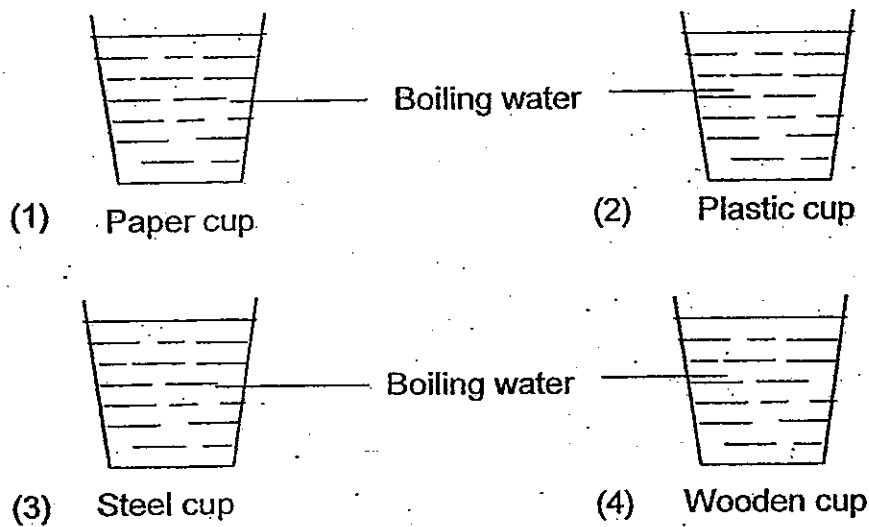

7. In the diagram below, what is the volume of Liquid X?

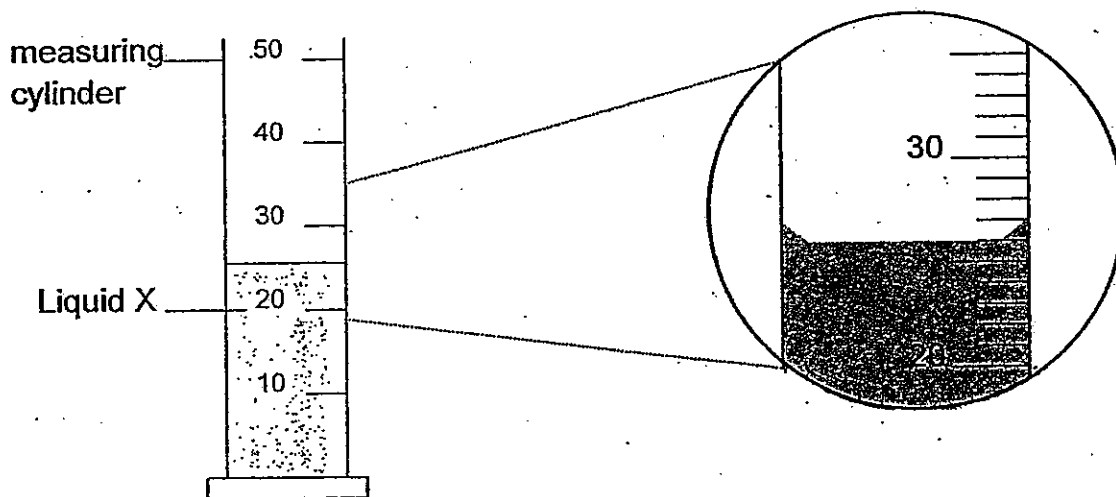

- (1) 26 ml
- (2) 27 ml
- (3) 33 ml
- (4) 34 ml

25. Thirty eggs of Organism X were placed in each of the three tanks, A, B and C. The table below shows the number of eggs hatched after two weeks.

Tank	Temperature in the tank (°C)	Number of eggs hatched after two weeks
A	20	10
B	30	30
C	40	25

Based on the table, what do you think was the aim of the experiment?

- (1) To find out if temperature affects how fast the eggs hatch.
- (2) To find out if temperature affects the number of eggs that will hatch.
- (3) To find out if temperature affects the size of the organisms hatched.
- (4) To find out if the temperature affects the gender of the organisms hatched.

26. The diagram below shows a torch, a piece of cardboard and a piece of transparent plastic.

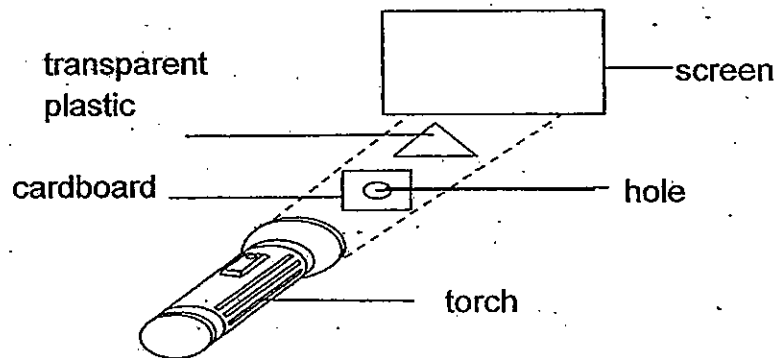

Which of the following shows the shadow formed on the screen when the torch is switched on?

(1)



(2)



(3)



(4)



27. Adel set up the experiment below. A copper rod was connected to two insulated beakers containing equal amounts of water at different temperatures.

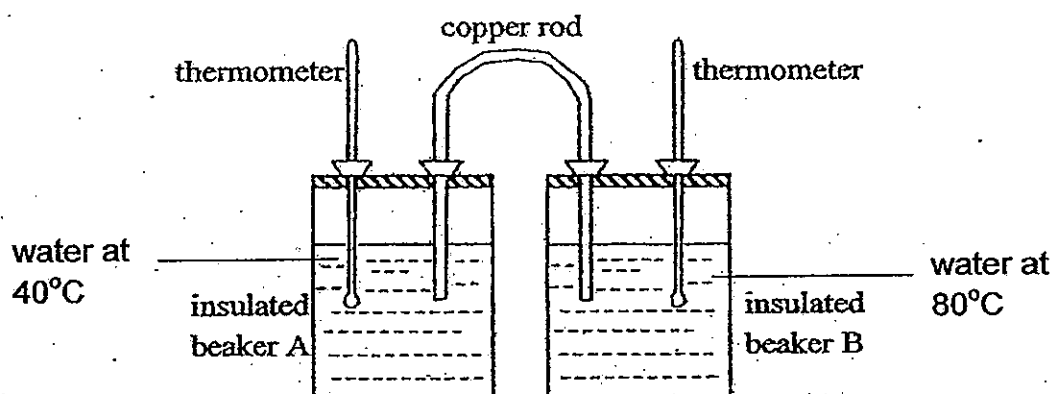

The time taken for the water in both beakers to reach the same temperature was recorded in the table below. The experiment was carried out with two other rods made of iron and aluminium.

Metal	Time taken for the water in both beakers to reach the same temperature (minutes)
Copper	10
Iron	45
Aluminium	24

What conclusion can you draw from this experiment?

- (1) Iron is an insulator of heat.
- (2) Iron is the best conductor of heat.
- (3) Aluminium does not conduct heat.
- (4) Copper is a better conductor of heat than iron and aluminium.

28. Joelle prepared two set-ups, X and Y, as shown below for her class to find out if the size of a magnet would affect its magnetism. However, a fair test could not be carried out using the set-ups.

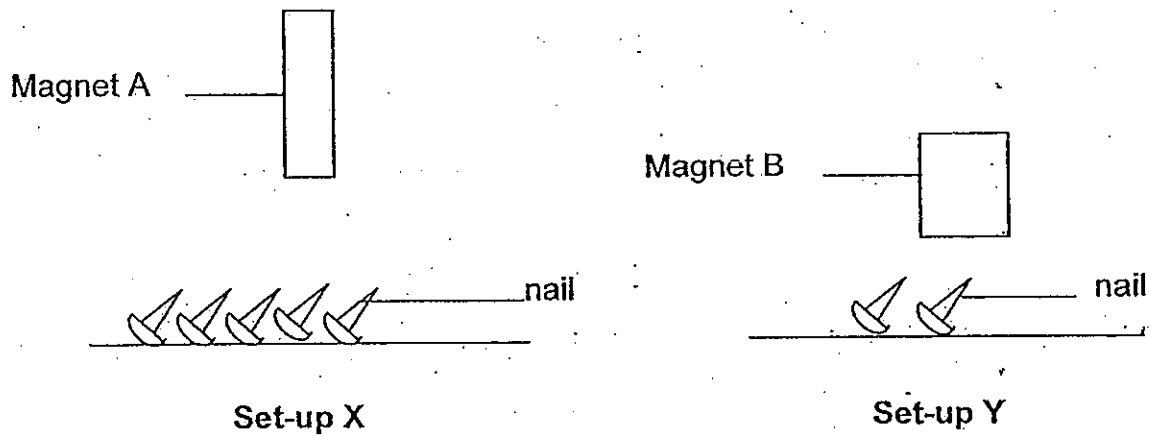

Which of the following should have been done to ensure that the investigation is fair?

- A: The number of nails should be the same.
 - B: The size of the magnets should be the same.
 - C: The distance between the nails and the magnet should be the same.
- (1) A and B only
(2) A and C only
(3) B and C only
(4) A, B and C
29. The drawing shows the image of a clock in a mirror. What is the actual time on the clock?

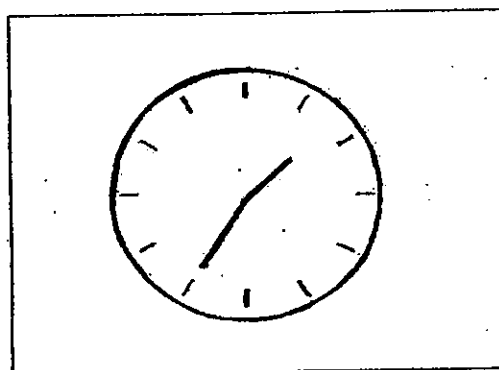
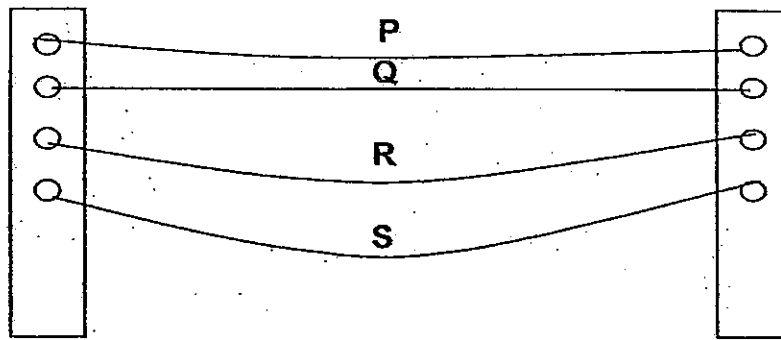

Image of wall clock in the mirror

- (1) 1.35
- (2) 5.50
- (3) 7.10
- (4) 10.25

30. Davan strung four wires of the same length but made of four different metals, P, Q, R and S, on two poles. The diagram below shows the lengths of the wires on a very hot day.



Two of the four metals, P, Q, R and S, used to make the wires were then used to make a bi-metallic strip. When heated for 5 minutes, it bent as shown in the diagram below.

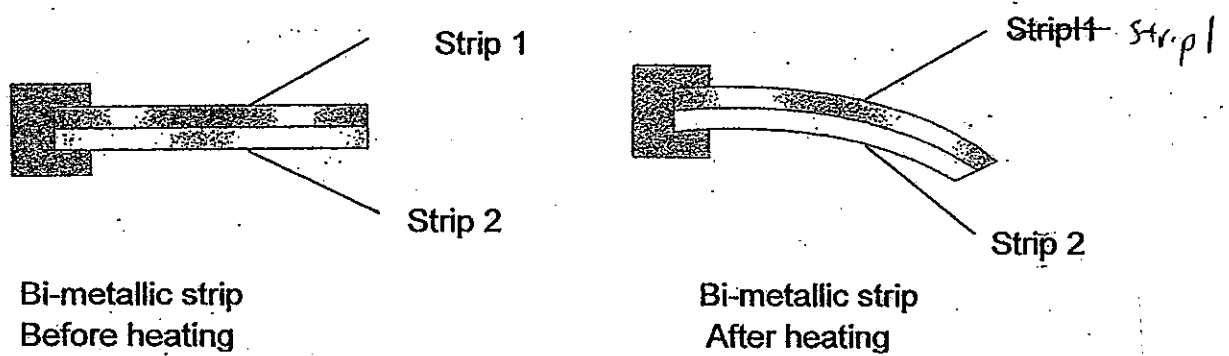

Which of the four metals, P, Q, R and S, were used to make Strip 1 and Strip 2 respectively?

	Strip 1	Strip 2
(1)	P	R
(2)	Q	P
(3)	R	S
(4)	S	Q

TAO NAN SCHOOL

PRIMARY 4 SCIENCE END-OF-YEAR EXAMINATION – 2010

Name : _____ ()

Date : 1 November 2010

Class : P4 _____

Time : 8.00 a.m. to 9.30 a.m.

Booklet B

INSTRUCTIONS TO CANDIDATES

Do not open this booklet until you are told to do so.

Follow all instructions carefully.

Answer all questions.

	Score	Marks
Section A		60
Section B		40
Total		100

Parent's signature: _____

Section B (40 marks)

For each question, 31 to 46, write your answers in the spaces provided.

31. Look at the diagram below.



Based on the diagram, it is an insect because it _____ (2m)

Tick the correct box (es).

- | | |
|--------------------------|-----------------------|
| <input type="checkbox"/> | can fly |
| <input type="checkbox"/> | has wings |
| <input type="checkbox"/> | has 6 legs |
| <input type="checkbox"/> | has 3 main body parts |

32. The picture below shows an oven.

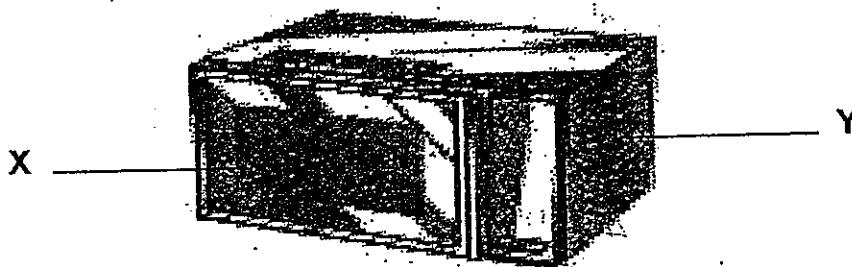

(a) Part X is made of glass because it allows _____ to pass through so that the cooking process of the food can be observed. (1m)

(b) Part Y is made of _____ because Y has to withstand high temperatures of the oven when food is being cooked. (1m)

33. The diagram below shows the stages in the life cycle of a beetle.

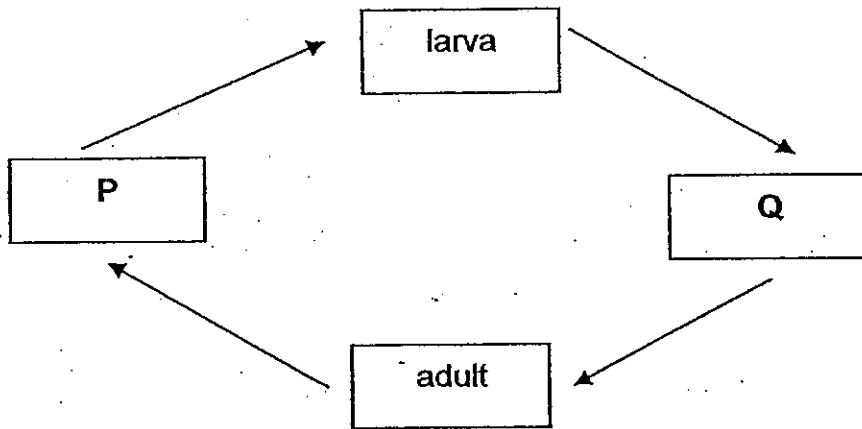

Choose the correct words from the box to answer the question below.

egg pupa nymph wriggler

Name the two stages, P and Q.

(2m)

P: _____

Q: _____

34. The drawing below shows a bottle of shampoo.



Identify the states of matter of the parts of the bottle of shampoo using the following helping words:

solid, liquid or gas

(a) The bottle is a _____

(1m)

(b) Shampoo is a _____

(1m)

35. When Sujesh enters a dark room, he sees a candle flame at a corner as shown below.

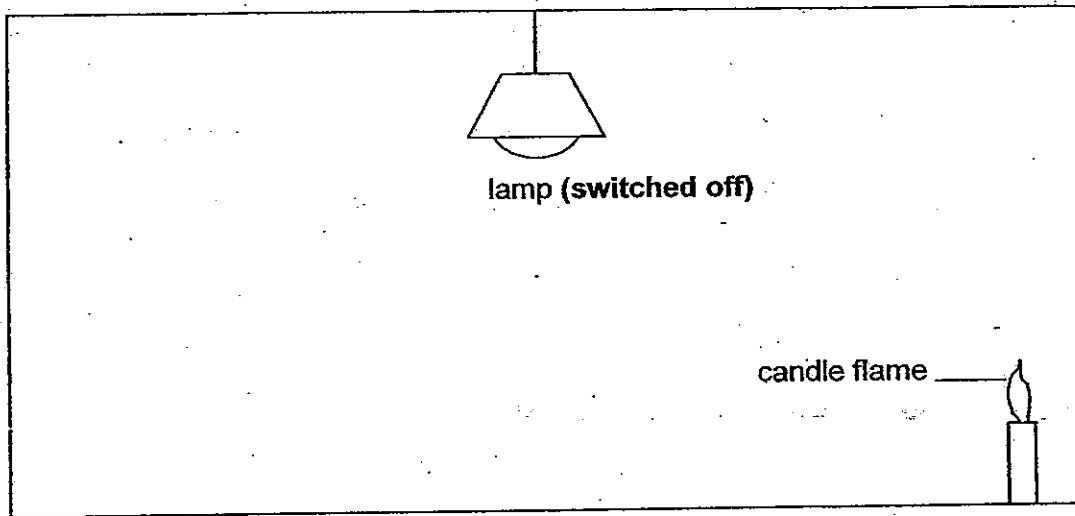

(a) Sujesh can see the candle flame because it _____ (1m)

When he switches on the light in the room, he sees both the candle flame and Object B.

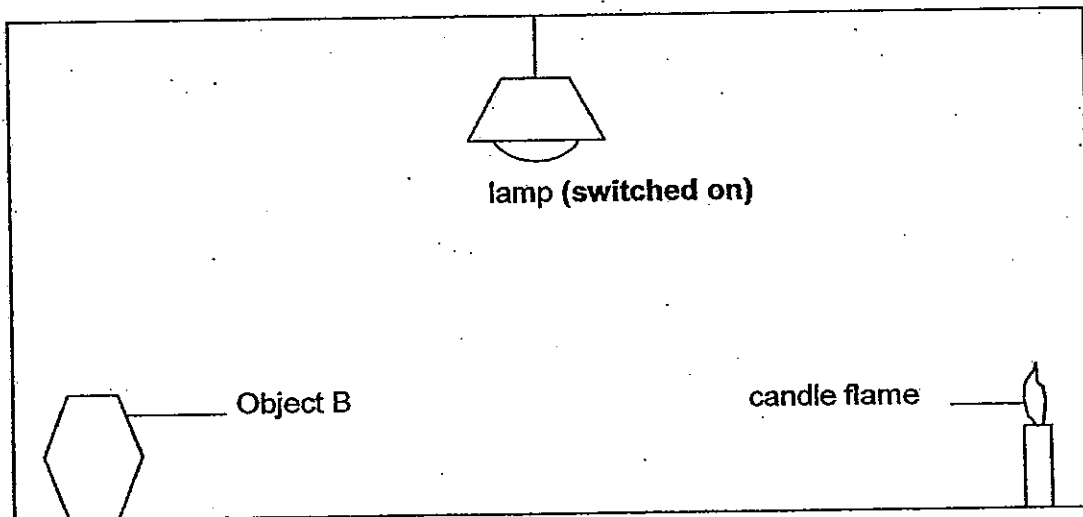

(b) Sujesh can see Object B because it _____ (1m)

36. Shanti placed a plant with two white flowers, X and Y, into a beaker containing water with red dye. After some time, Flower X turned red whereas Flower Y remained white. Shanti made two cuts on the plant and her observations of the cross-sections of the stem where the cuts were made are shown below.

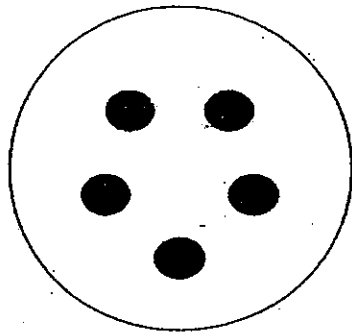

Cross- section of Cut 1

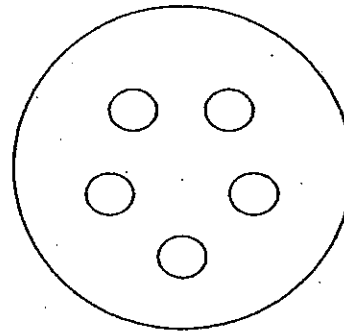

Cross- section of Cut 2

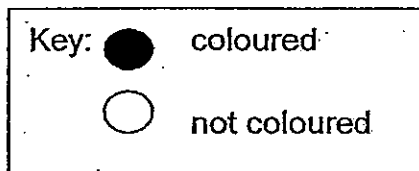

(a) Cut 1 is shown in the diagram below. Fill in one of the boxes to indicate where Cut 2 was made in order for Shanti to make the observations shown above. (1m)

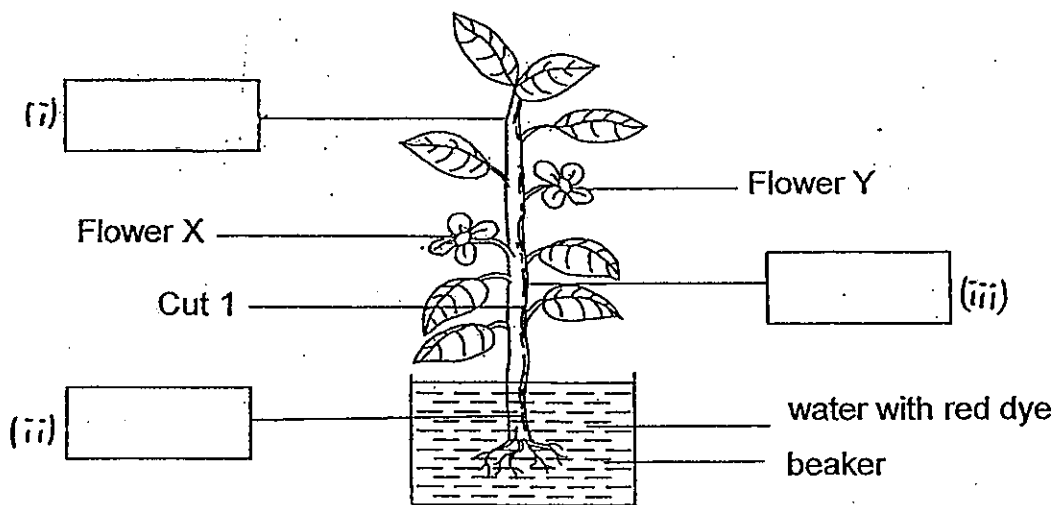

(b) Explain why Flower X turned red. (2m)

37. Rani bought a toy made of glass shown in the diagram below. She covered the upper surface of Bulb B with both her palms for some time. At the fifth minute, the coloured liquid in Bulb B started moving up to Bulb A.

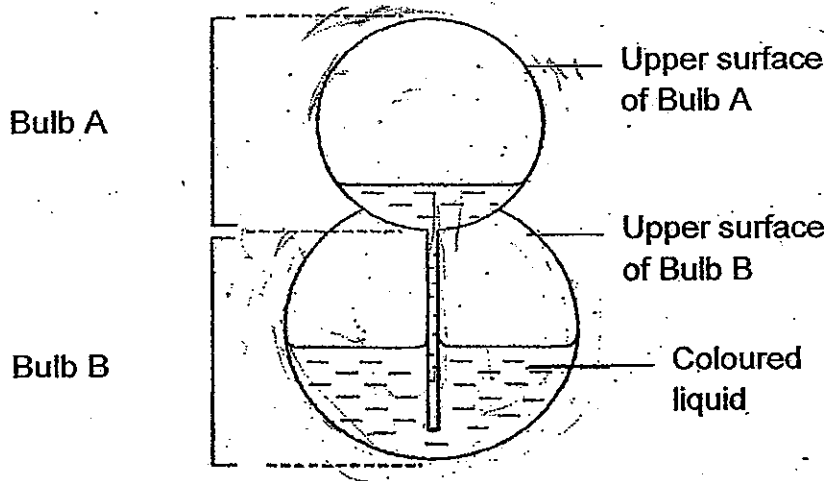

- (a) Explain why the coloured liquid in Bulb B moved up to Bulb A. (1m)

- (b) What should Rani do to make the coloured liquid move from Bulb A back to Bulb B? (1m)

- (c) If Rani were to construct a similar toy using thinner glass, how much time will it take for the water to move up from Bulb B to Bulb A when she covered the upper surface of Bulb B with both her palms for some time? (1m)

38. Lily put a pot of plant inside a black box with a hole. She placed the set-up in a well-lit place and watered the plant daily. After 3 days, she observed the growth of the plant as shown in the drawing below.

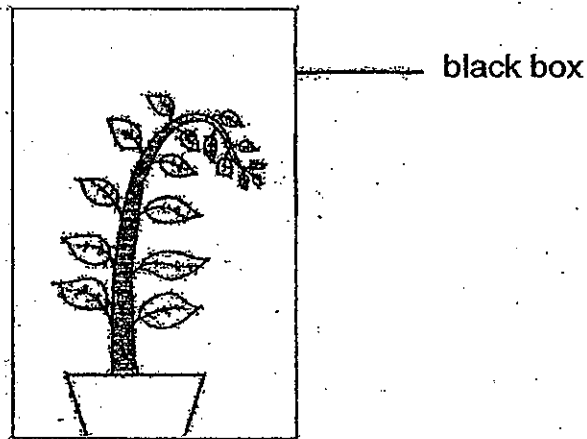

- (a) Indicate, with a cross, 'X', on the black box, to show where the hole could be. (1m)
- (b) Explain your answer in part (a). (1m)

Lily was told that she should have a control set-up for her investigation so that she could ensure that her investigation was fair.

- (c) Write down 2 variables that must be kept constant in the control set-up. (1m)
- (i) _____
- (ii) _____

39. Study the characteristics of 5 organisms, A, B, C, D and E, found in a park in the flowchart below.

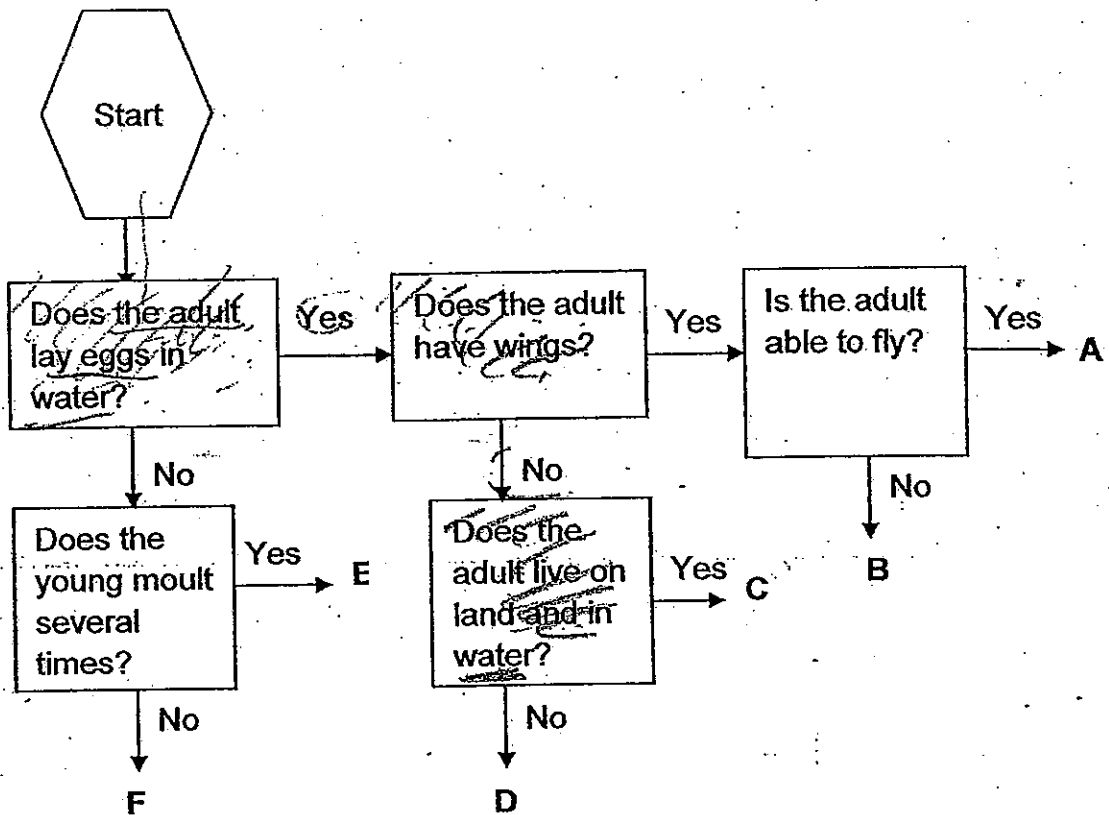

(a) Based on the flowchart, write down the characteristics of organism C. (2m)

(b) Based on the flowchart, which two organisms have two similarities? (1m)

40. In the experimental set-up below, Xiaomin placed an object between the light source and the white screen. A shadow is formed on the white screen.

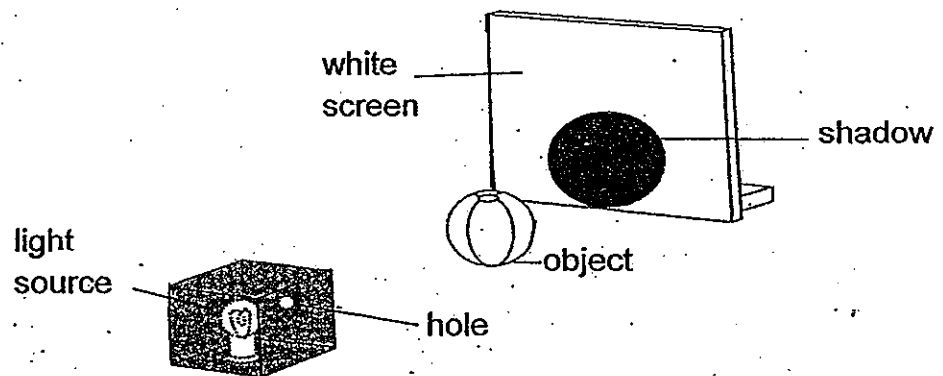

The table below shows part of the results of the experiment Xiaomin conducted with the set-up. She forgot to write down part of the results of the experiment.

Distance between the light source and screen (cm)	Distance between the object and screen (cm)	Height of shadow (cm)
30	12	20
30	15	X
30	18	Y
30	21	Z

- (a) Based on the information in the table, arrange the heights of the shadows, X, Y and Z, in ascending order. (1m)

- (b) Write down one difference between the shadows of heights, X and Z. (Do not mention their height and size.) (1m)

Xiaomin added a clear red plastic sheet between the light source and the object as shown below.

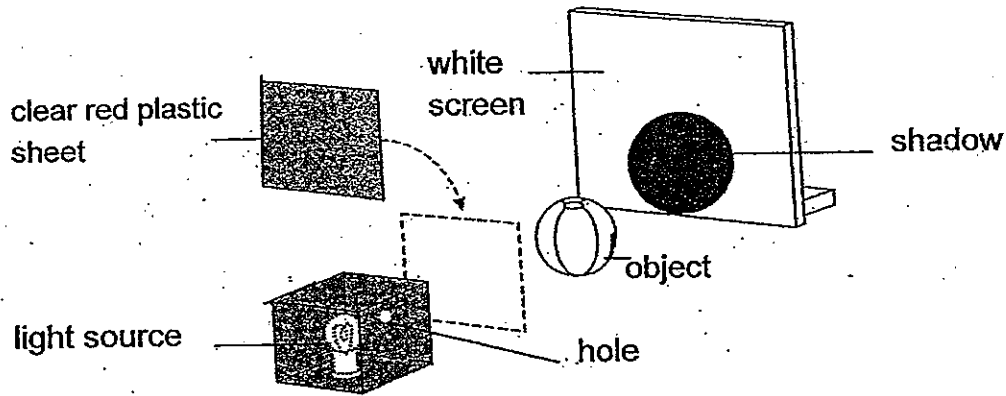

(c) Draw and label what would be observed on the white screen in the space below. (1m)

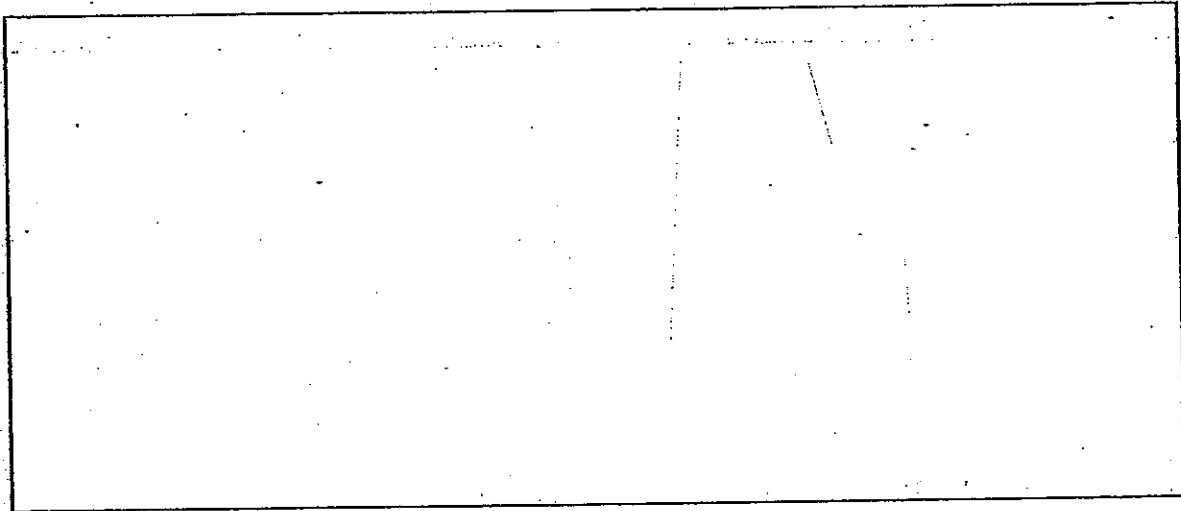

(d) If a marble that is smaller than the object is placed between the object and the screen, no shadow will be cast on the screen by the marble. Explain why that happens. (1m)

41. The diagram below shows a maze with four entrances. Two boys, Peter and Ali, are standing at one entrance each.

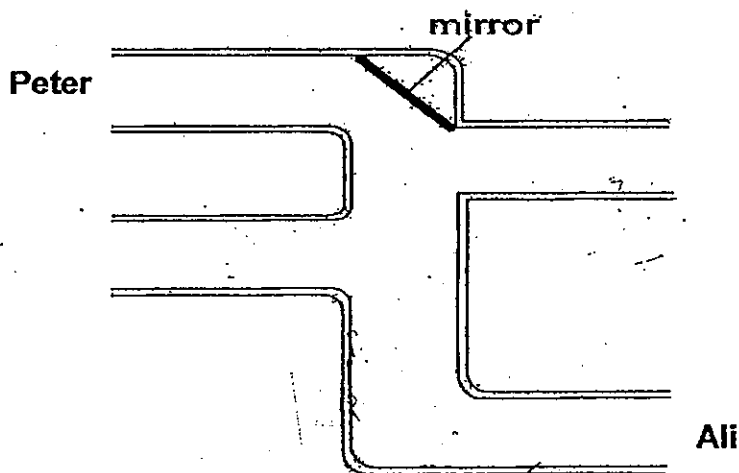

- (a) Draw and label, where you would place one more mirror in the maze so that Peter and Ali can see each other at their respective positions. (1m)

- (b) Explain why Peter can see Ali. (2m)

42. Two metal cups, Cup A and Cup B, are stuck together as shown in the diagram below.

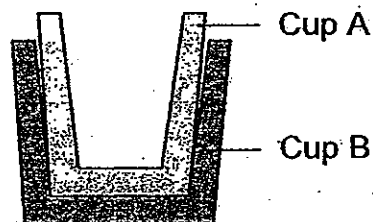

You are given the following items to help you separate them without using your hands to force them apart.

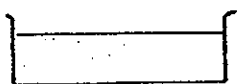

Trough of water at room temperature

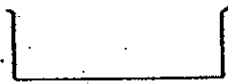

Trough

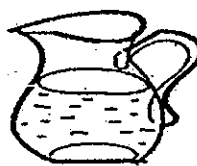

Jug of hot water

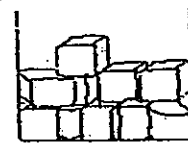

Ice cubes

(a) Which three of the items would you use to help you separate the cups in the shortest possible time? (1m)

(b) Write down and explain the steps you would take to separate the cups using the items you have chosen. (3m)

Step 1: _____

Step 2: _____

Step 3: _____

43. Winnie set up an experiment as shown below.

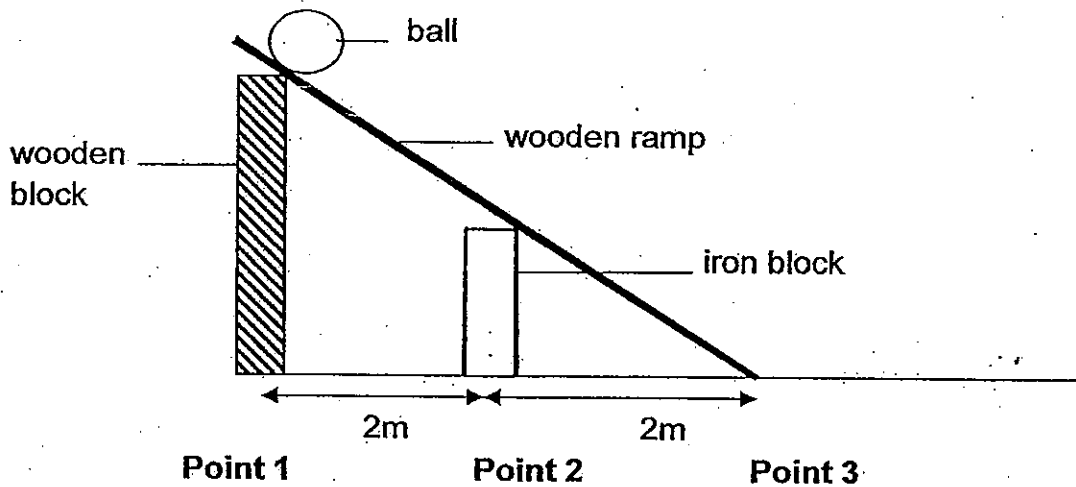

She released the ball down the ramp. Point 2 is midway of Point 1 and Point 3.

The table below shows the time the ball took to roll from Point 1 to Point 2 and from Point 2 to Point 3 respectively.

Reading	Time the ball took to roll (seconds)	
	From Point 1 to Point 2	From Point 2 to Point 3
1 st	3	5
2 nd	2	6
3 rd	3	6

(a) Based on the table, what could the ball be? (1m)

(b) Why were three readings taken for the experiment? (1m)

(c) What should Winnie do to reduce the time the ball took to roll from Point 2 to Point 3? (1m)

44. The graph below shows how the length of Shane's shadow changes over a period of time as he walks in a straight line near a street lamp at night.

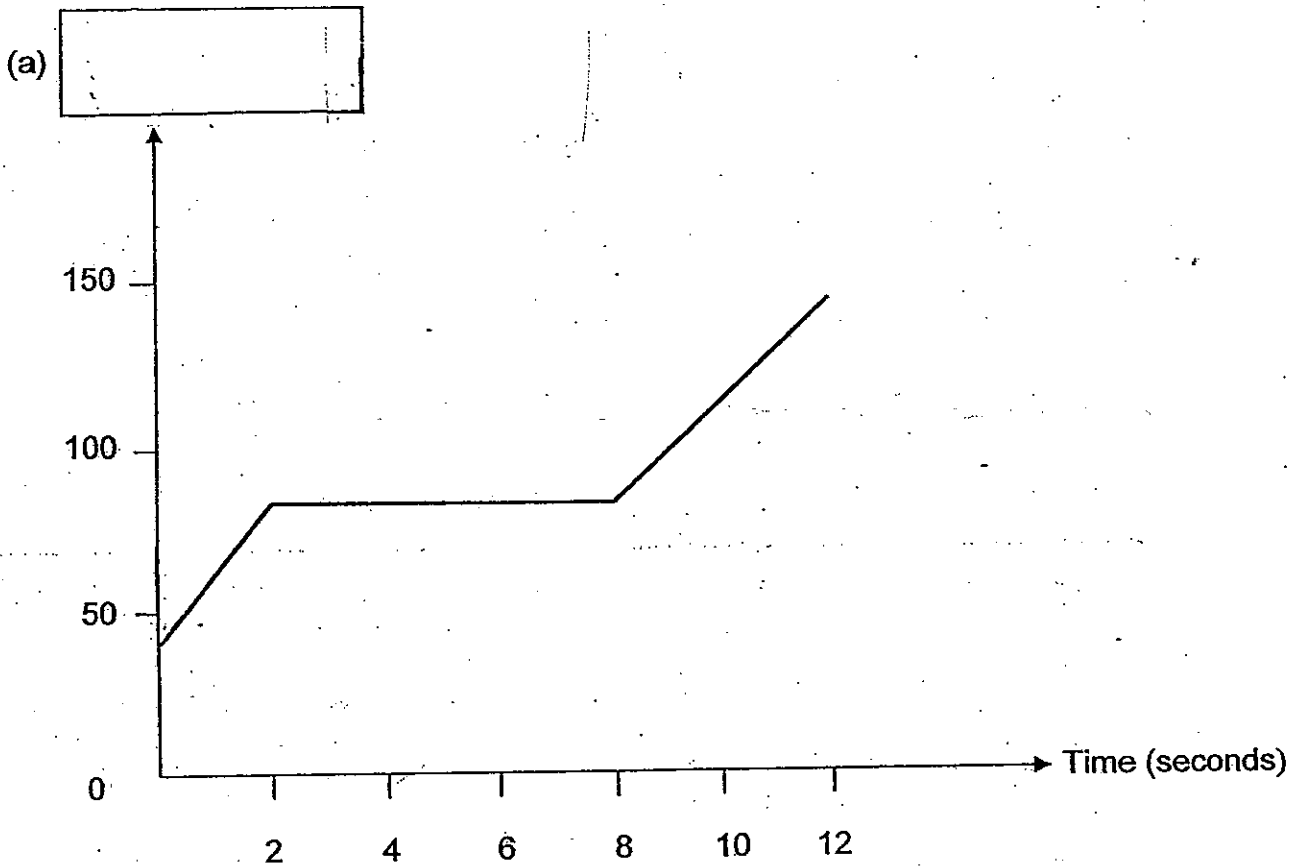

- (a) Label the vertical axis of the graph in the box provided. (1m)
- (b) What is the relationship between the length of the shadow and the time he walked near the street lamp, from the 2nd second to the 8th second? (1m)
- _____
- _____
- (c) Based on the graph, how long did Shane stop walking? (1m)
- _____
- (d) Indicate on the graph with an 'X' when Shane was nearest to the street lamp. (1m)

End of Paper



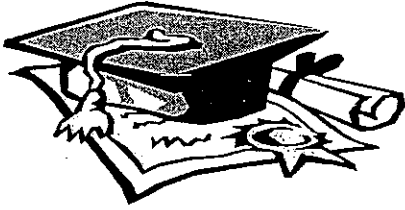

ANSWER SHEET

EXAM PAPER 2010

**SCHOOL : TAO NAN PRIMARY
SUBJECT : PRIMARY 4 SCIENCE**

TERM : SA2

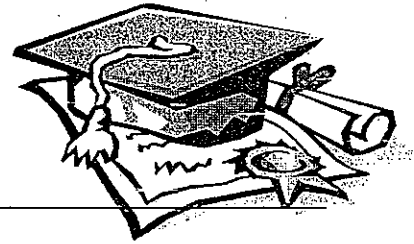

Q1	Q2	Q3	Q4	Q5	Q6	Q7	Q8	Q9	Q10	Q11	Q12	Q13	Q14	Q15	Q16	Q17
1	4	2	4	4	3	1	2	4	3	2	2	4	1	2	3	1

Q18	Q19	Q20	Q21	Q22	Q23	Q24	Q25	Q26	Q27	Q28	Q29	Q30
4	4	3	1	3	1	3	2	4	4	2	4	4

31) has 6 legs has 3 main body parts

32) a) light b) steel

33) P: egg Q: pupa

34) a) solid b) liquid

35) a) gives out light b) reflects light into his eyes

36) a) i) Cut 2

b) The water with red dye was absorbed by the roots, passed through the stem and gets transported to Flower X.

37) a) Air in Bulb B expands when heated and push the coloured water up to Bulb A.

b) She should cover the Bulb A with both her palms for some time.

c) It will take less than five minutes.

38) a)

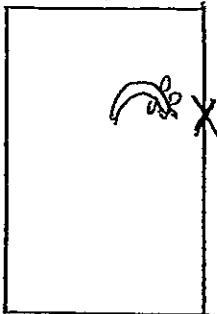

b) Plants grow towards light which is needed for it to make food.

39)a) Organism C lays eggs in water, the adult does not have wings and the adult lives on land and water.

b) Organism C and organism D.

40)a) X, Y, Z

b) Shadow X is clear but shadow Y is blue.

c)

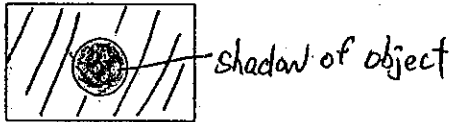

d) The object which is bigger will prevent the light from reaching the marble so a shadow cannot be cast by the marble.

41)a)

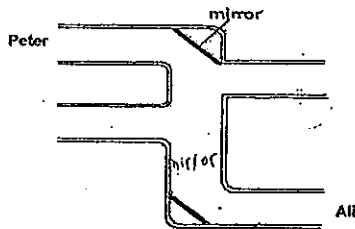

b) Light travel in straight lines. Light is reflected from Ali onto the mirror and then into Peter's eyes.

42)a) Trough, Jag of hot water and Ice cubes.

b)1: Pour the hot water into the Trough.

2: Put the Ice cubes in cup A so it will contract.

3: Place cup B in the Trough of hot water so it will expand. The two cups will be separated.

43)a) The ball could be a magnet.

b) This was to ensure that the results were reliable.

c) Push the wooden ramp so it is at a steeper angle.

44)a) Length of the shadow.

b) The shadow remained at the same length from the 2nd second to the 8th second.

c) 6 second.

d)

