



Temasek Primary School

Semestral Assessment 2

Primary Four

2016

**SCIENCE
(Booklet A)**

Name: _____ ()

Class: Primary 4 _____

Date: 25 October 2016

Parent's Signature: _____

60 Marks

Total Time for Booklet A and B: 1h 45 min

INSTRUCTIONS TO CANDIDATES

1. Write your name, class and register number in the spaces provided clearly.
2. Do not open this booklet until you are told to do so.
3. Follow all instructions carefully.
4. Answer all questions.
5. Shade your answers in the Optical Answer Sheet (OAS) provided.

For each question from 1 to 28, four options are given. One of them is the correct answer. Make your choice (1, 2, 3 or 4). Shade your answer on the Optical Answer Sheet.

(56 marks)

1. Matter is anything that has mass and occupies space. Which one of the following is not an example of matter?

- (1) air
- (2) light
- (3) bottle
- (4) motorcycle

(Go on to the next page)

2. The diagram below shows a plant

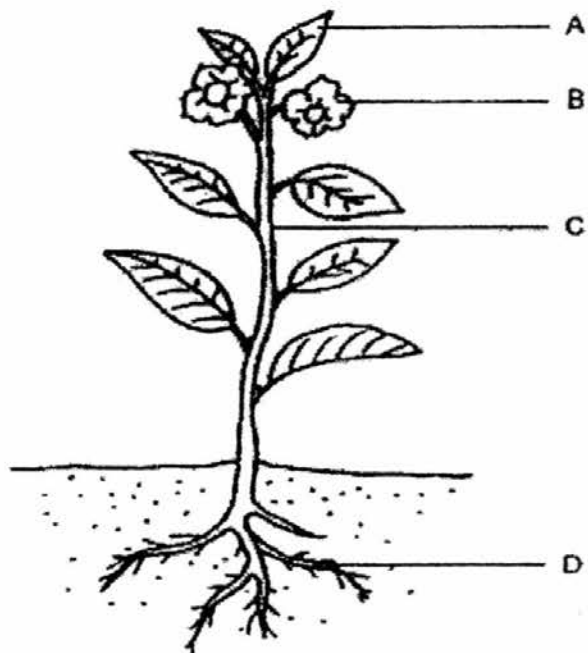

Which one of the following parts, A, B, C or D, would hold the plant upright?

- (1) A
- (2) B
- (3) C
- (4) D

(Go on to the next page)

3. Which of the following explains why a shadow is formed?

- A Light is blocked.
- B Light travels in a straight line.
- C Light is reflected from objects.
- D Light passes through some objects.

- (1) A and B only
- (2) A and C only
- (3) B and D only
- (4) C and D only

(Go on to the next page)

4. Hashim placed four spoons of different materials in a basin of hot water at 90°C as shown in the diagram below.

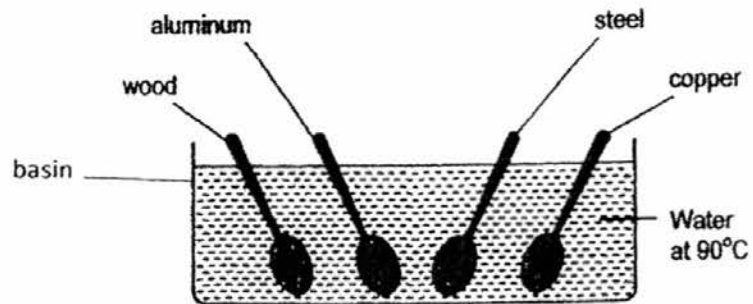

Which spoon is he able to hold comfortably in his hands after 5 minutes?

- (1) steel spoon
- (2) copper spoon
- (3) wooden spoon
- (4) aluminium spoon

(Go on to the next page)

5. The diagram below shows a human digestive system.

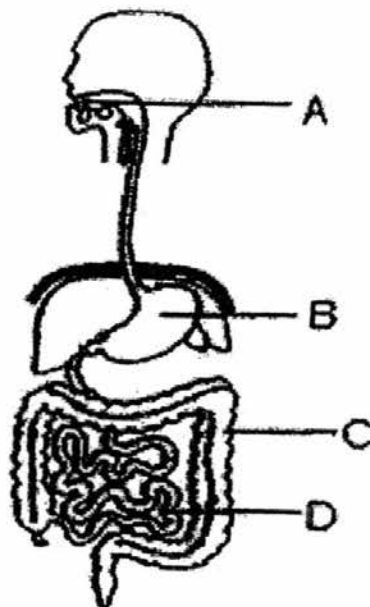

At which part of the human digestive system is water absorbed from the undigested food?

- (1) A
- (2) B
- (3) C
- (4) D

(Go on to the next page)

6. The diagram below shows the life cycle of animal X.

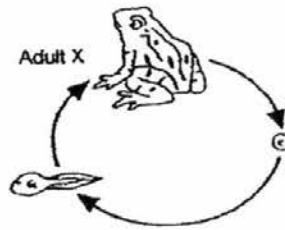

Based on the diagram above, which of the following statements are not true about the life cycle of animal X?

- A It gives birth to its young alive.
 - B It has three stages in its life cycle.
 - C Its young closely resembles its parents.
-
- (1) A and B only
 - (2) A and C only
 - (3) B and C only
 - (4) A, B and C
-
7. Which one of the following can be attracted by a magnet?
- (1) steel spoon
 - (2) plastic spoon
 - (3) wooden spoon
 - (4) rubber spoon

(Go on to the next page)

8. Ronnie places a metal spoon in a cup of hot tea.

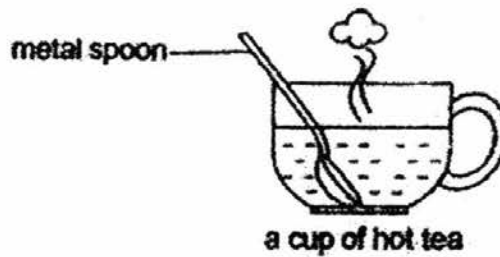

The spoon becomes hotter after a while. Which one of the following explains this?

- (1) The cup loses heat to the hot tea.
- (2) The spoon loses heat to the hot tea.
- (3) The spoon gains heat from the hot tea.
- (4) The hot tea gains heat from the spoon.

(Go on to the next page)

9. The diagram below shows the stages in the life cycle of a butterfly.

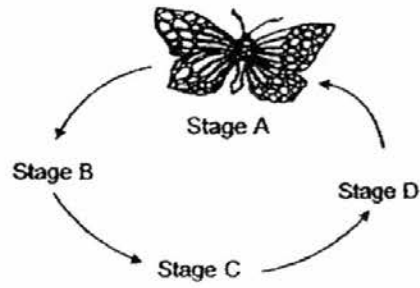

Which of the following is the correct stage for stage C?

- (1) egg
- (2) pupa
- (3) larva
- (4) adult

(Go on to the next page)

10. Sophie brought one end of a bar magnet near objects X, Y and Z one at a time.

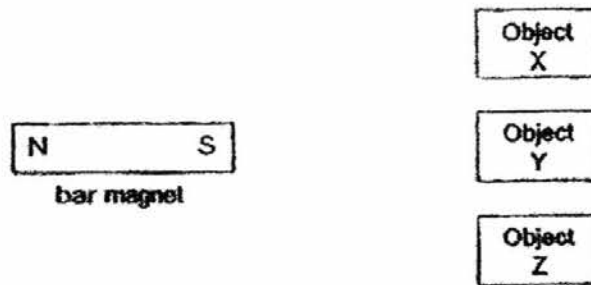

She recorded her observations below.

- Object X is repelled.
- Object Y is attracted.
- Object Z does not move.

Based on her observations, which of the following is/are definitely a magnet(s)?

- (1) Object X only
- (2) Object Z only
- (3) Object X and Y only
- (4) Object Y and Z only

(Go on to the next page)

11. Daryl set up two balances using three types of plastic balls, P, Q and R, filled with air. He hung two balls at the same time at each end of the balance, as shown below.

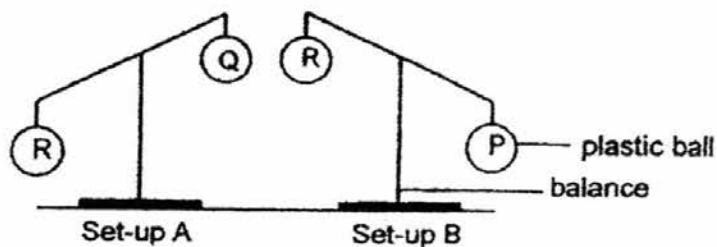

Which of the following statement(s) made by Daryl about the set-ups is/are correct?

- A R is as heavy as P.
 - B P has the least mass.
 - C P is heavier than R but lighter than Q.
 - D R is heavier than Q but lighter than P.
-
- (1) B only
 - (2) D only
 - (3) B and D only
 - (4) A and C only

(Go on to the next page)

12. Two identical syringes, P and Q, were completely filled with water and air respectively. The openings of both syringes were sealed as shown in the diagram below.

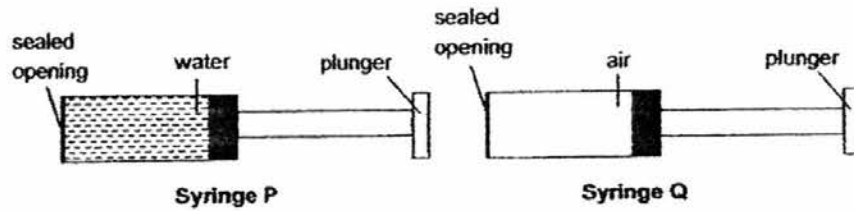





Which one of the following could be Syringe P and Syringe Q when the plungers were pushed in?

	Syringe P	Syringe Q
(1)		
(2)		
(3)		
(4)		

(Go on to the next page)

13. Linda set up an experiment to find out the effect of different amount of light on an indoor plant. She placed four pots of similar plants under different conditions and recorded the results in the table below.

Plant	Amount of light (hours)	Average growth per week (cm)
	4	1
	6	4
	8	6
	10	3

Which variables must Linda keep constant to ensure a fair experiment?

- A Amount of soil
- B Amount of sunlight
- C Amount of water
- D Amount of fertilizer

- (1) A and D only
- (2) B and C only
- (3) A, B and C only
- (4) A, C and D only

(Go on to the next page)

14. Gary's Science teacher showed him a potted plant. He was told that it had been kept in a box for one week and had been watered daily. The box was placed in the open school field.



Which of the following boxes could the potted plant have been placed in?

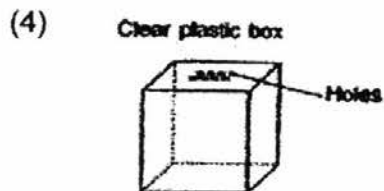
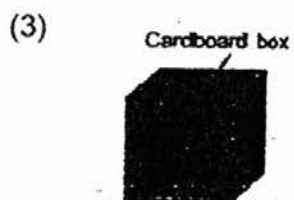
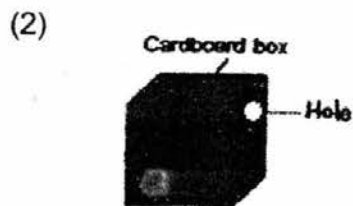
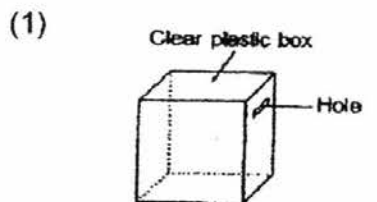

(Go on to the next page)

15. Kelly set up her experiment with sheets made of different materials, P, Q, R and S, as shown in the diagram below. She cuts a hole on material Q and a light shadow can be seen on sheet S when the torch is switched on.

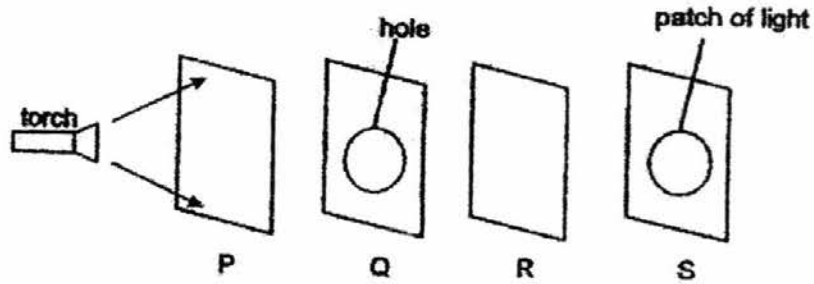

Which of the following materials are sheets, P, Q, R and S, most likely made of?

	P	Q	R	S
(1)	glass	frosted glass	wood	steel
(2)	glass	steel	frosted glass	wood
(3)	frosted glass	steel	frosted glass	glass
(4)	frosted glass	glass	wood	frosted glass

(Go on to the next page)

16. The diagram below shows some paths of light, A, B, C, D, E and F.

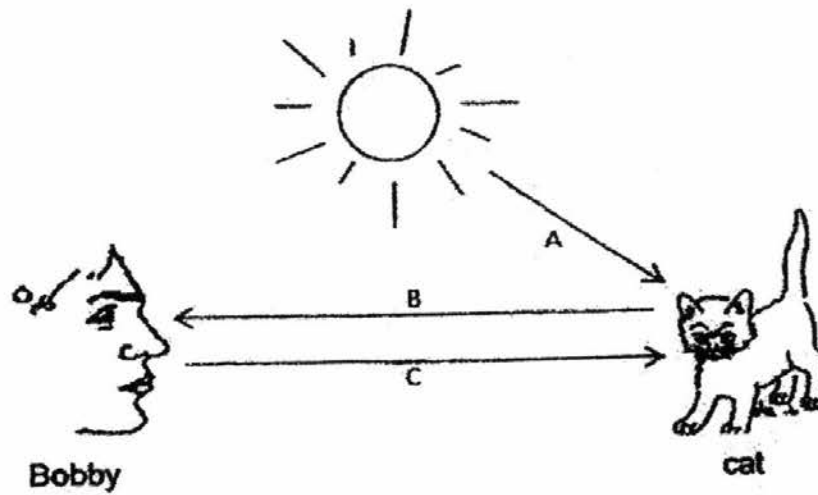

Which path(s) of light allowed Bobby to see the cat?

- (1) A only
- (2) C only
- (3) A and C only
- (4) A and B only

(Go on to the next page)

17. Sean wanted to investigate the degree of transparency of four materials, P, Q, R and S. Before he began measuring the transparency of the four materials, he noted that the transparency of a clear plastic sheet is 10 units. The results of his experiment are shown in the graph below.

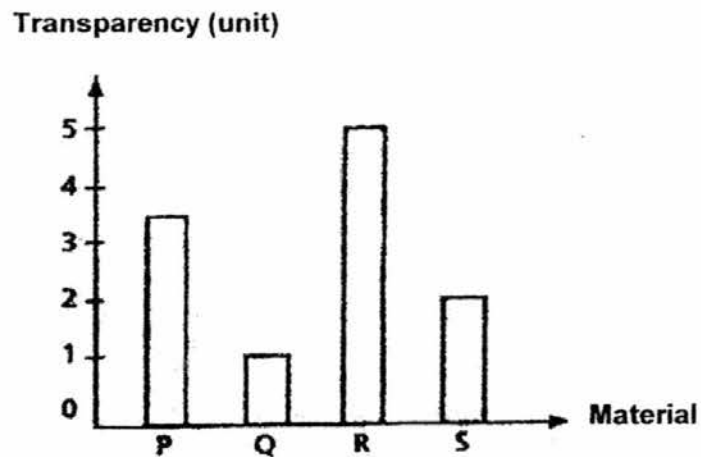

Which material will cast the lightest shadow when the torchlight is shone on it in a dark room?

- (1) Material P
- (2) Material Q
- (3) Material R
- (4) Material S

(Go on to the next page)

18. Study the diagram of an experiment below which was carried out in a dark room. A torch, a ball, a narrow pole and a screen were placed on a table in a straight line directly in front of one another. The torch was switched on and the direction of light was indicated below.

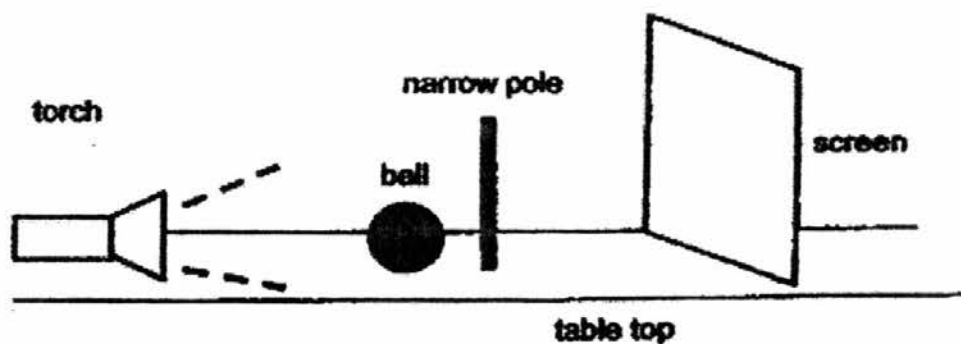

Which one of the following shadows could most likely be formed on the screen?

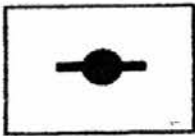
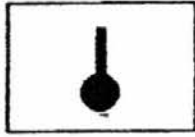
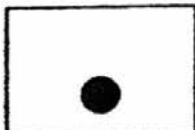
- (1) 
- (2) 
- (3) 
- (4) 

(Go on to the next page)

19. The diagram below shows an experiment set-up.

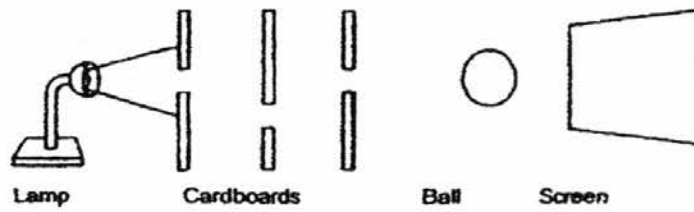

4 students, Ann, Ben, Chris and Dawn, each makes a statement based on the set-up.

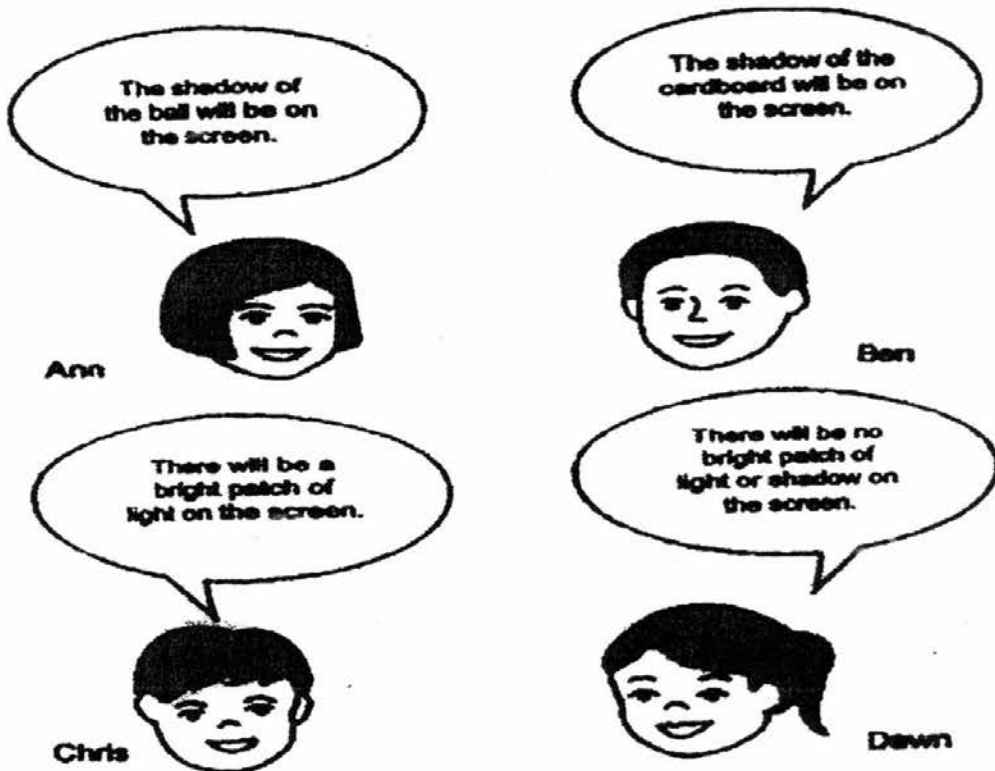

Whose statement is correct?

- (1) Ann
- (2) Ben
- (3) Chris
- (4) Dawn

(Go on to the next page)

20. Jack is walking under a street lamp at night as shown below.

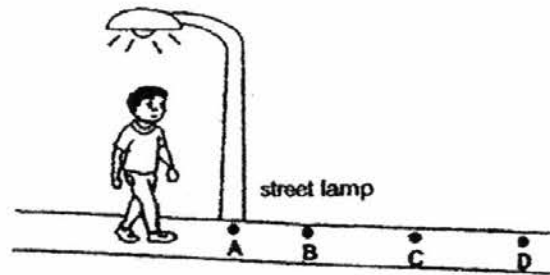

At which point will his shadow be the longest?

- (1) A
 - (2) B
 - (3) C
 - (4) D
21. Miss Wong conducted an experiment as shown below.

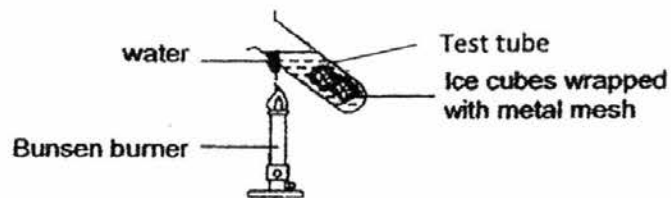

After a few minutes, the ice cubes have not melted completely. What can you conclude from the above experiment?

- (1) Metal is a poor conductor of heat.
- (2) Water is a poor conductor of heat.
- (3) Test tube is a good conductor of heat.
- (4) Water is a good conductor of heat.

(Go on to the next page)

22. Study the experiment shown in the diagram below.

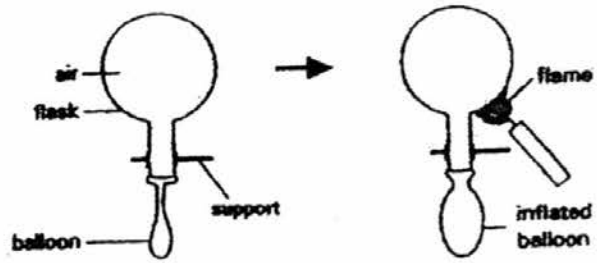

What does this experiment show us about the property of air?

- (1) Air has mass.
- (2) Air can be compressed.
- (3) Air expands when heated.
- (4) Air has no definite volume.

(Go on to the next page)

23. Shaza had a square metal frame with four similar drops of wax attached at P, Q, R and S as shown below.

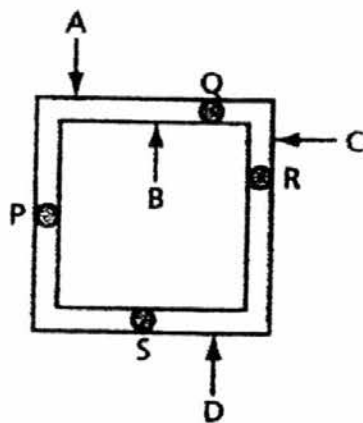

Shaza heated the metal frame at only one of the points, A, B, C or D and observed the order in which the wax melted completely.

She recorded her observations in the table shown below.

Order of wax completely melted	Wax at position
1 st	S
2 nd	R
3 rd	P
4 th	Q

At which point, A, B, C or D did Shaza heat the metal frame?

- (1) A
- (2) B
- (3) C
- (4) D

(Go on to the next page)

24.



After boiling some water, Fahmi poured the water into a jug and a cup as shown in the diagram above.

Which statement(s) below about the jug and the cup of water is/are correct?

- A The temperature of the water in the jug and cup are the same immediately after they were filled.
 - B There was more heat energy in the jug of water than the cup of water.
 - C Equal amount of ice is needed to cool down the hot water in both the jug and the cup.
-
- (1) A only
 - (2) A and B only
 - (3) B and C only
 - (4) A, B and C

(Go on to the next page)

25. Four similar eggs, L, M, N and P, were each dropped into four similar beakers at the same time as shown in the diagram below.

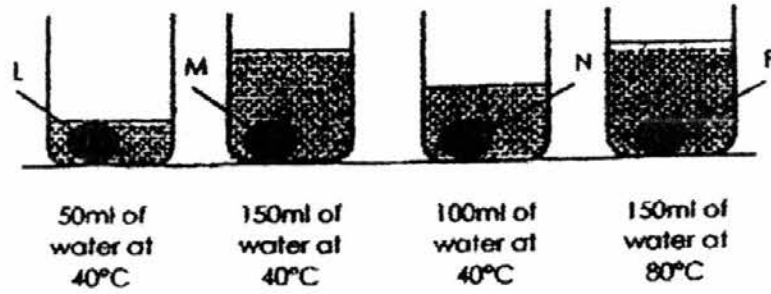

They were left in the beakers for three minutes. Then the eggs were taken out and cracked.

Which one of the following shows the correct order of the eggs starting from the most cooked to the least cooked?

- (1) P, N, M, L
- (2) L, N, M, P
- (3) P, M, N, L
- (4) L, M, N, P

(Go on to the next page)

26. There are two containers, X and Y, of equal size and equal thickness. Container X is made of aluminium but container Y is made of plastic. Each container is filled with 500 ml of boiling water before they are covered with a sheet of glass and left at room temperature for 30 minutes.

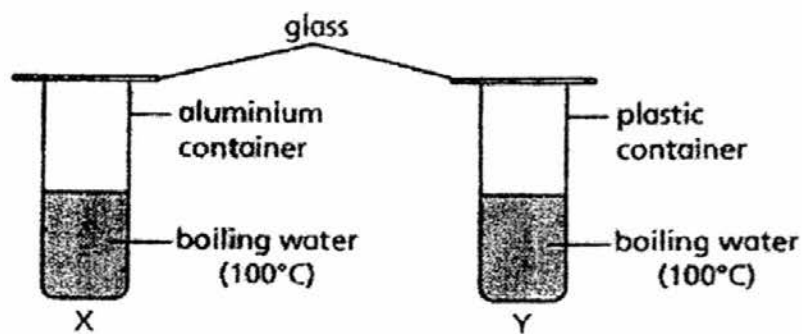

Which of the following line graphs shows the most possible changes in the temperature of the water in the two containers?

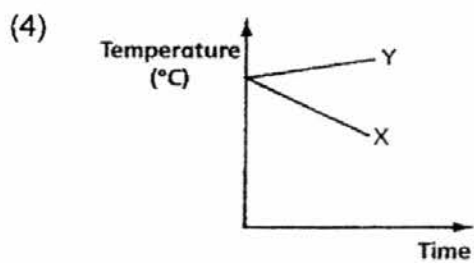
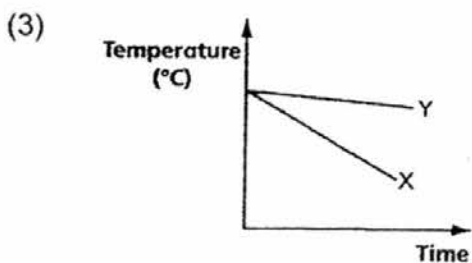
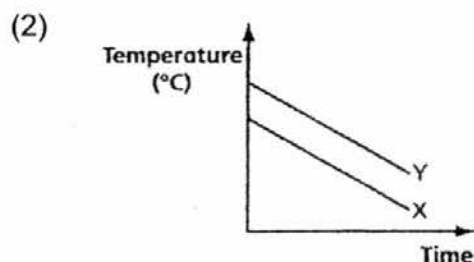
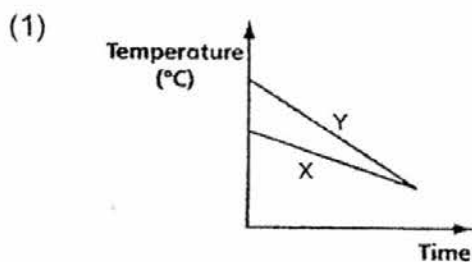

(Go on to the next page)

27. The table below shows a comparison between what happens in our small and large intestines.

	Small intestine	Large intestine
A	Food is completely digested.	Some of the food is being digested.
B	Digested food is absorbed into the blood.	Undigested food is absorbed into the blood.
C	Digested food is absorbed into the blood.	Digested food is not absorbed into the blood.

Which of the comparisons A, B or C between the small intestine and the large intestine is/are correct?

- (1) A only
- (2) C only
- (3) A and B only
- (4) B and C only

(Go on to the next page)

28. Observe the diagram below.

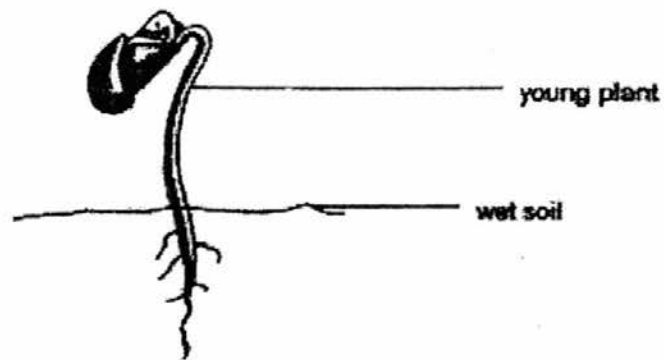

David planted a seed in some wet soil and placed it in a dark corner of a room. A few days later, the seed grew into a young plant as shown above. Which of the following statements about the seed is true?

- (1) The seed can make its own food.
- (2) The seed needs light to germinate.
- (3) The seed uses its stored food to grow.
- (4) The seed gets its food from the wet soil.

(Go on to the next page)



Temasek Primary School

Semestral Assessment 2

Primary Four
2016

SCIENCE
(Booklet B)

Name: _____ ()

Class: Primary 4 _____

Date: 25 October 2016

Parent's Signature: _____

Total Time for Booklet A and B: 1h 45 min

INSTRUCTIONS TO CANDIDATES

1. Write your name, class and register number in the spaces provided clearly.
2. Do not open this booklet until you are told to do so.
3. Follow all instructions carefully.
4. Answer all questions.
5. Write your answers in this booklet.

Paper	Marks	Scores
Booklet A	60	
Booklet B	40	
Total	100	

For each question, write your answers in the spaces provided.

(44 marks)

29. Lila shines a torch on Object A.

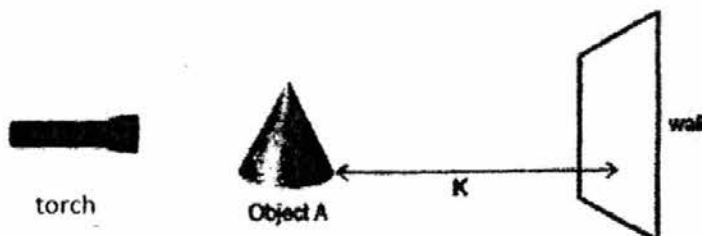

She draws the shadow that forms on the wall and label it as shadow L.

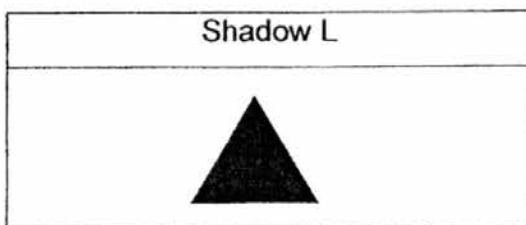

Lila then flips Object A on its side, as shown below.

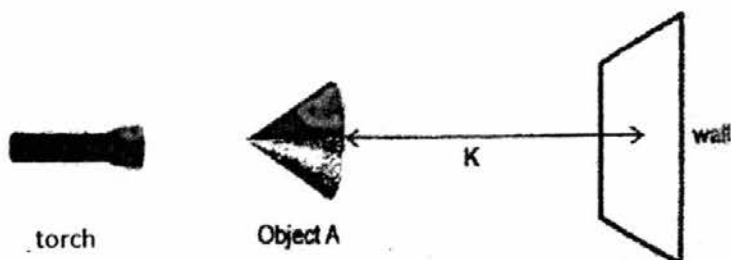

(a) Draw in the box below the shadow, M, that will form on the wall when Lila shines the torch again

[1]

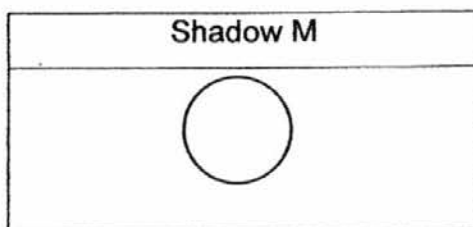

(b) A shadow is formed when light is _____ by an opaque object.

[1]

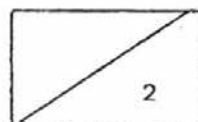

30. The diagram below shows the human digestive system.

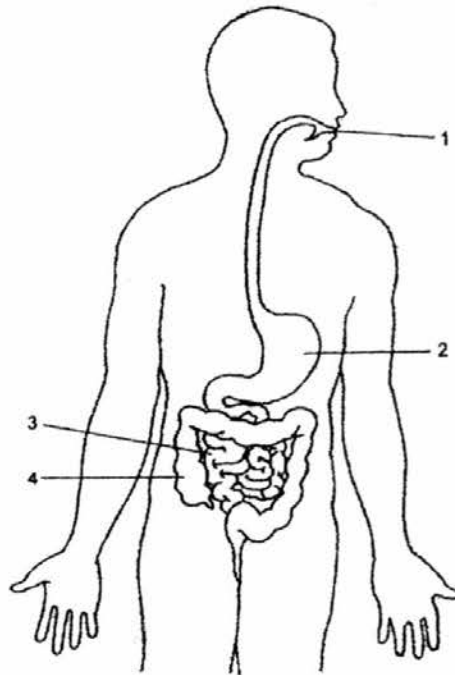

Identify the part where

(a) digestion first takes place: _____ [1]

(b) there is no digestion: _____ [1]

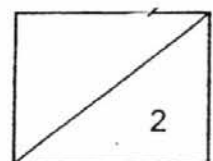

31. The diagrams below show the two life cycles, X and Y, of insects.

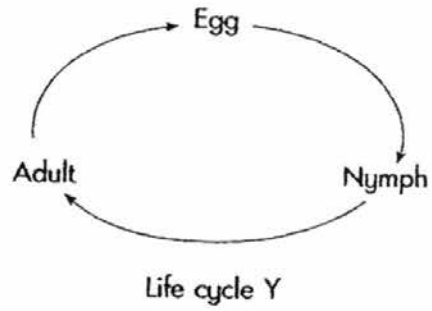
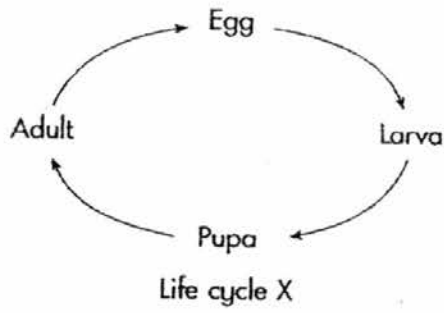

Classify the following insects according to the life cycles they have. [3]



Mosquito



Butterfly



Cockroach

Life cycle X	Life cycle Y

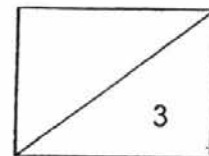

32. Put a tick (✓) in the correct box to indicate if each statement is True or False.

[3]

	Statement	True	False
(a)	A piece of aluminium can be magnetized by passing electricity through it.		
(b)	A smaller magnet always has a weaker magnetic force than a larger magnet.		
(c)	The magnetic force of a magnet is the strongest at its poles.		

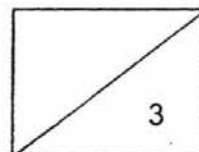

33. Study the diagram below carefully.

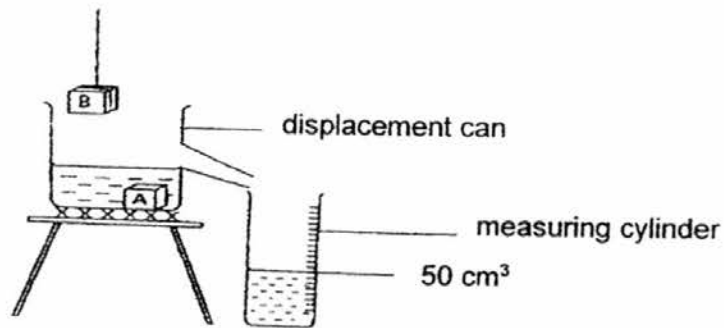

When block A is lowered into the displacement can, 50cm^3 of water flows from the can into the measuring cylinder. When block B is lowered into the can, with block A still in the can, the level of water in the measuring cylinder increased to 120cm^3 .

- (a) What can be concluded about the volume of block B compared to block A? [1]

- (b) State one property of a solid that can be shown from the experiment. [1]

- (c) Block A was removed from the displacement can and heated evenly over a flame for five minutes. The volume of block A after heating was 52cm^3 . Explain why. [1]

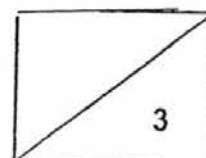

34. The capacity of jar A and B is 200cm^3 each. Each jar contains 200cm^3 of air.

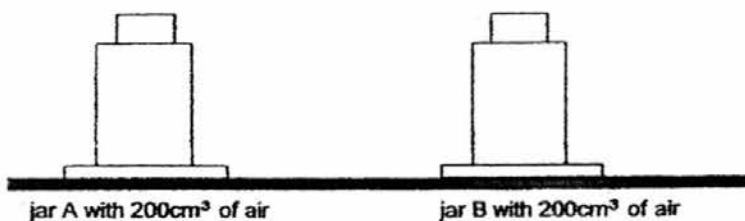

Jenny conducted an experiment and connected a pump to each jar as shown in the diagram below. She pumped another 100cm^3 of air into jar A. Both jars were then placed on a mass balance.

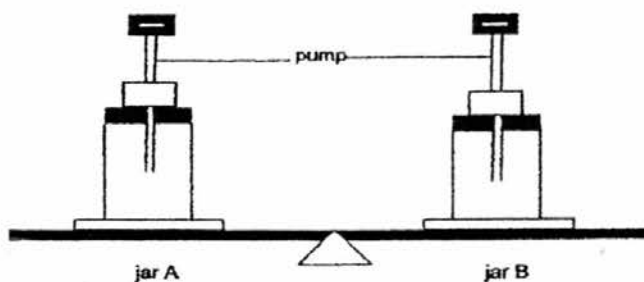

- (a) State one observation she would make when 100cm^3 of air is pumped into jar A. [1]

- (b) What is the volume of the air in jar A in the end? [1]

- (c) State two properties of air that are shown in the experiment above. [2]

Property 1: _____

Property 2: _____

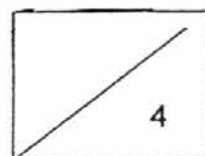

35. Faith observed the growth of a seed as shown below.

She then recorded the mass of the seed from stage W to stage Z.

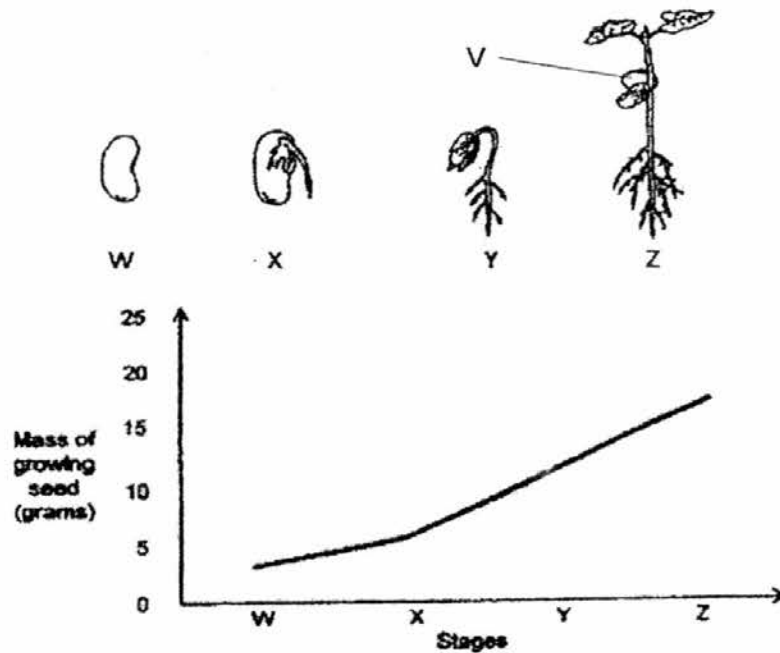

- (a) From the results, the mass of the growing seed increased from stage W to stage Z. Explain why. [1]

- (b) Look at stage Z. Name the part labelled V. [1]

- (c) Faith removed the part labelled V. Will the young plant continue to grow? Explain your answer. [1]

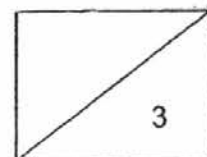

- 36(i) Sheila puts a balsam plant each into Flask X and Flask Y. She removed only the roots of the balsam plant in Flask X.
- Both flasks were then left in the open at the same location and the volume of water in each flask was measured and recorded over five days.

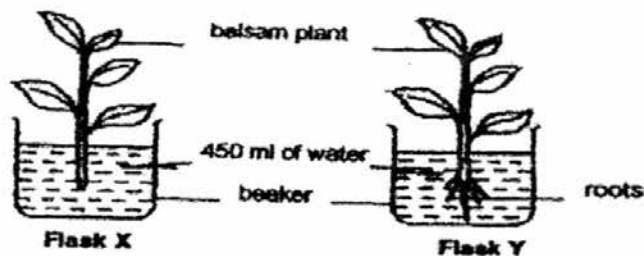

The graphs below show the changes in the volume of water in both flasks over a period of five days.

- (a) Study the two graphs shown below. Which graph best represents the change in volume of water in Flask X and Flask Y over a period of five days? Label X and Y in the two boxes below. [1]

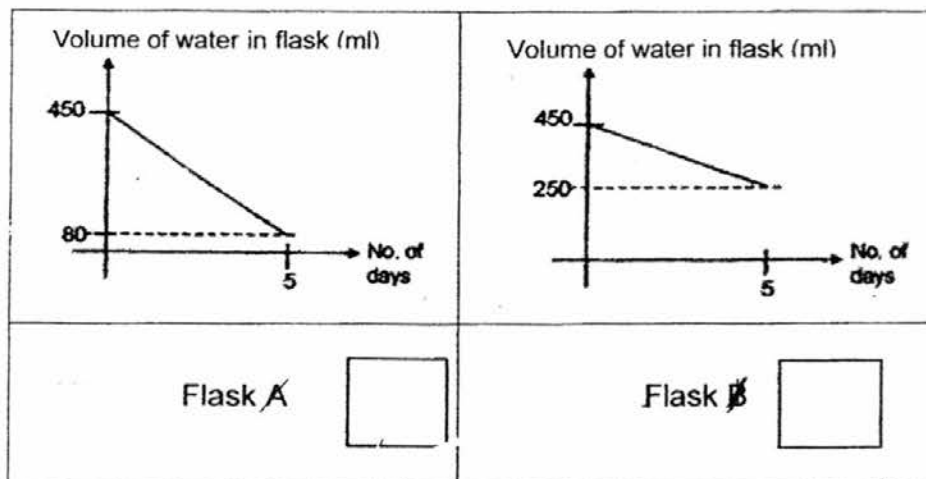

- (b) Give a reason for your answer in (a). [1]

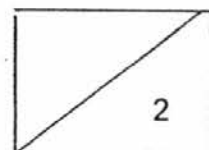

36(ii) Then, Sheila set up another experiment in a dark room.

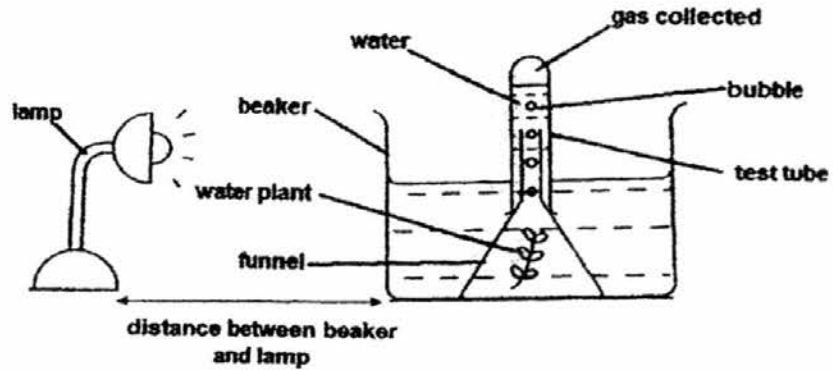

She counted the number of gas bubbles released by a water plant per minute when the beaker was placed at different distances away from the lamp. Her results were as follows:

Distance between beaker and lamp (cm)	5	10	15	20	25
Number of gas bubbles released per minute	15	11	9	?	2

- (a) Predict the likely number of gas bubbles released per minute when the distance between the beaker and lamp is 20cm. [1]

- (b) What is the relationship between the distance between the beaker and the lamp and the number of gas bubbles released per minute? [1]

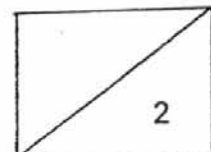

37. Andy set up an experiment in a dark room as shown below. A ball was placed in between sheets P and Q. When the torch was switched on, a dark shadow of the ball was cast on sheet R only.

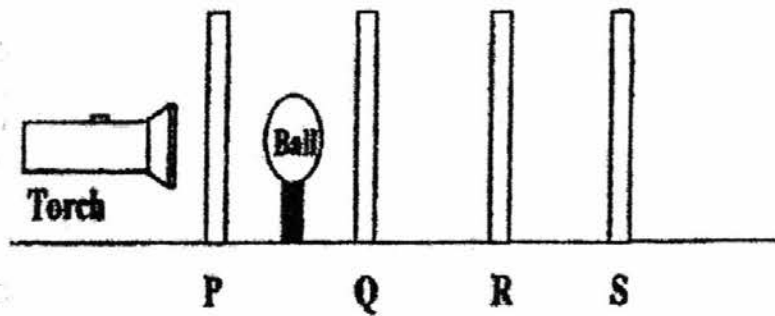

- (a) What conclusion could Andy draw about sheets P and Q? [1]

- (b) If Andy removed sheet S, what would happen to the shadow formed on sheet R? Explain your answer. [2]

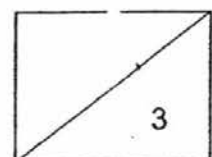

38. In a dark room, Johnny placed a torch and a ~~cup~~^{cardboard} board with a hole in front of a screen as shown below. He then switched on the torch and a bright spot was observed on the screen.

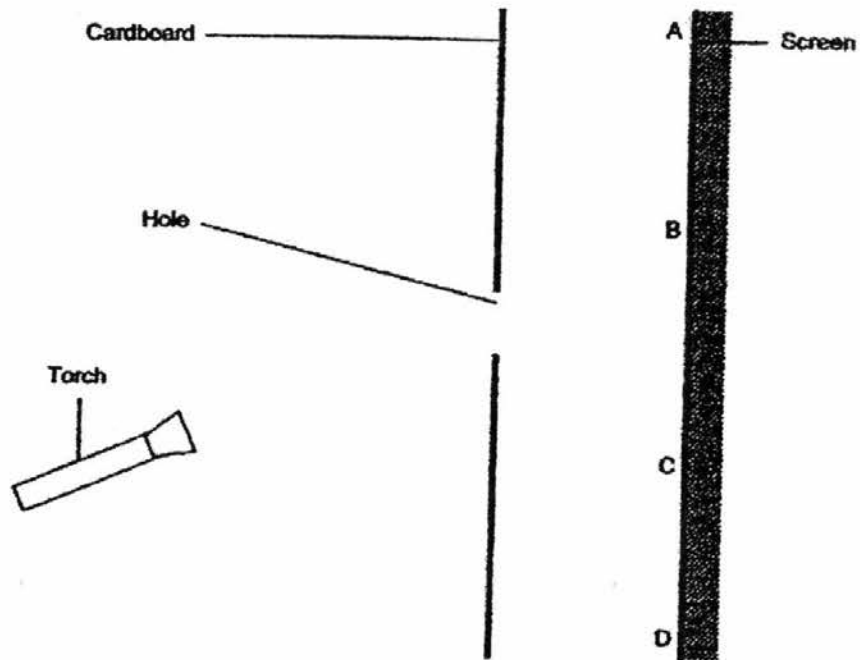

- (a) Which point on the screen, A, B, C or D, was the bright spot most likely observed. [1]

- (b) Johnny also noticed that there were no bright spots observed on the **other points** on the screen. Explain this observation. [1]

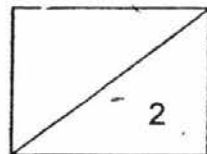

- (c) Johnny later replaced the cardboard with a toy dinosaur. Upon switching on the torch, he observed a shadow of the toy dinosaur on the screen.

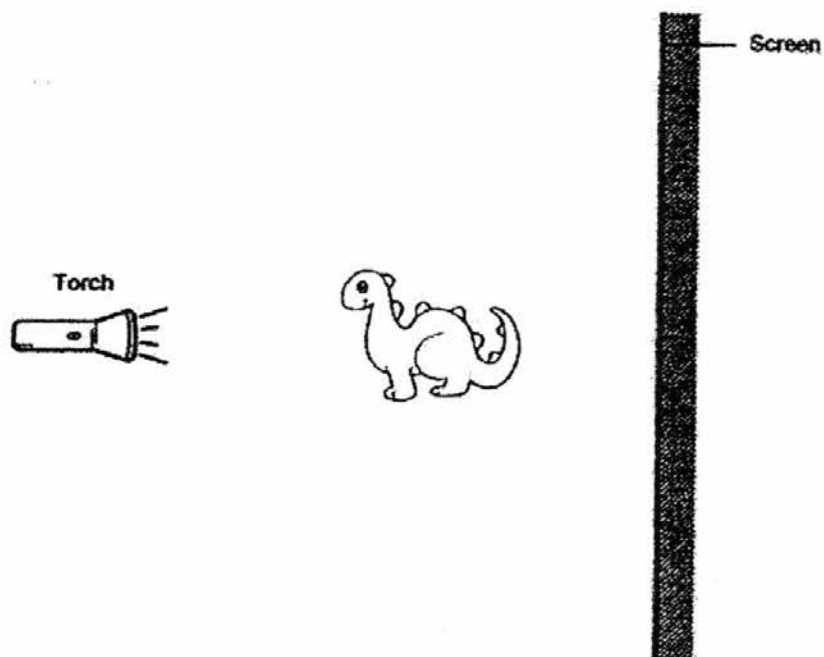

- (i) Explain how the shadow of the toy dinosaur was formed. [1]

- (ii) Describe how the size of the dinosaur's dark shadow will change if Johnny moves his dinosaur closer to the screen. [1]

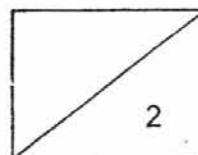

39. Two metal cups, P and Q, were stacked together and could not be separated. Sam placed the cups in a basin filled with ice cubes as shown below. He realised that the cups still remained stuck together. His mother suggested that he should also use hot water.

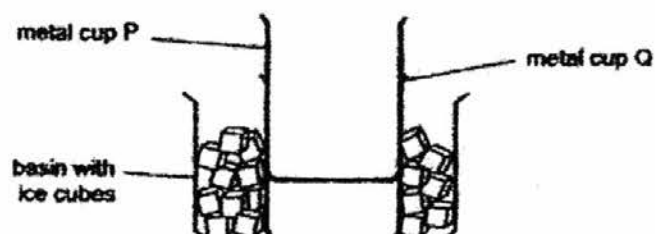

- (a) Using both ice cubes and hot water, what could Sam do to separate the two metal cups? [1]

- (b) Explain your answer in ⁽⁹⁾~~(10)~~ words. [2]

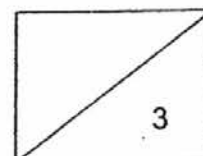

40. Joseph set up the experiment below.

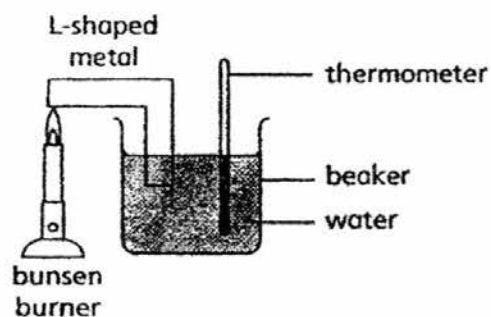

(a) Why did Joseph place a thermometer in the beaker of water? [1]

(b) What will happen to the temperature of the water after the L-shaped metal bar is heated strongly for five minutes? Why? [2]

(c) What was he trying to find out from the experiment? [1]

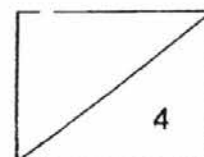

41. The diagram below shows the digestive system of a human body.

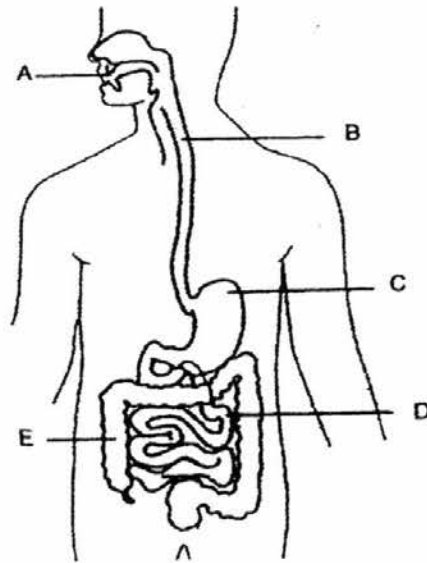

(a) State the function of part B in the diagram above. [1]

(b) What is the substance found in Part C that helps break down the food into simpler substances? [1]

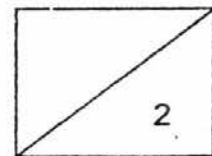

- (c) The graph below shows the amount of digested and undigested food in parts A, C and D of the digestive system.

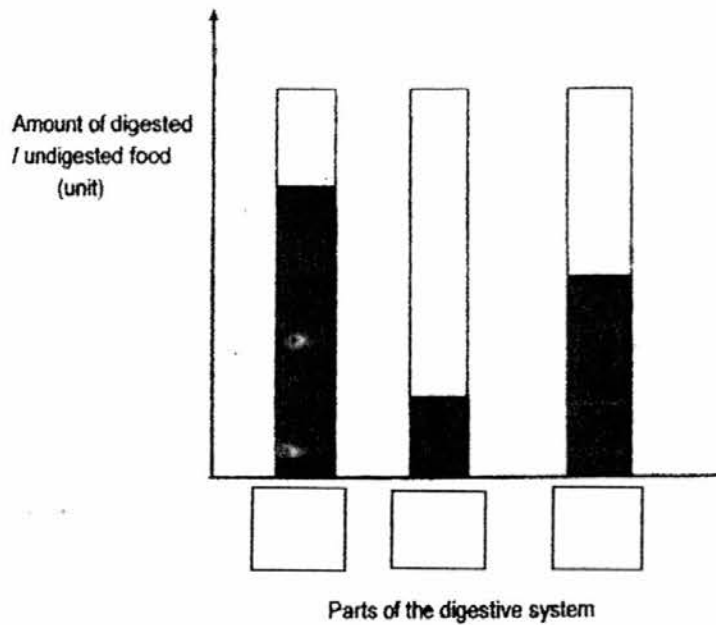
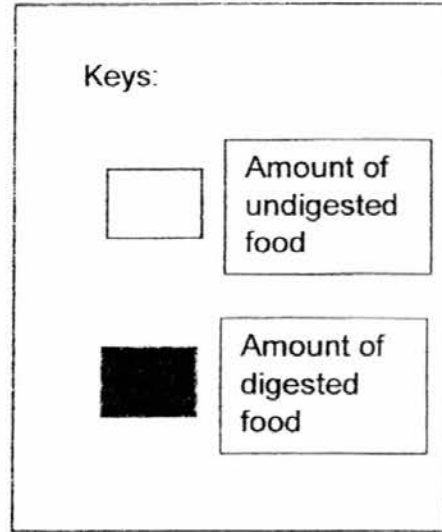

Write the letters, A, C and D in the respective boxes above. [1]

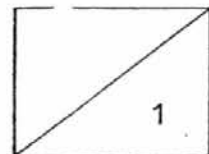

42. Adam wanted to find out if the number of batteries affected the strength of the electromagnet. He had two set-ups, A and B, as shown below.

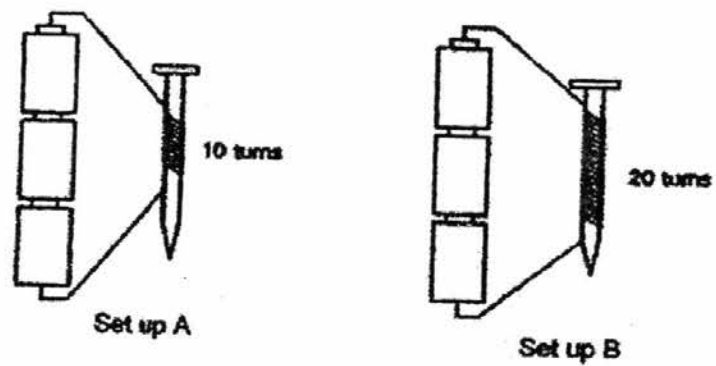

Adam's teacher said that the experimental set-up was wrong.

- (a) Suggest two ways in which Adam should do to ensure that the experimental set-ups were correct. [2]

Suggestion 1:

Suggestion 2:

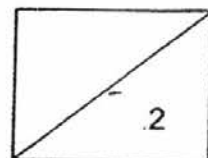

- (b) Adam repeated the experiment by comparing two set ups. One of the set-ups had an aluminium nail as shown below. He then placed each nail into a tray of paper clips.

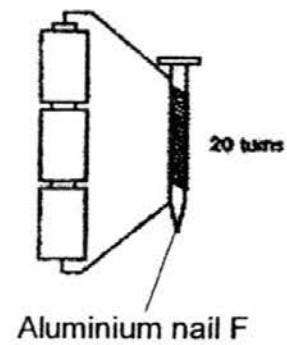
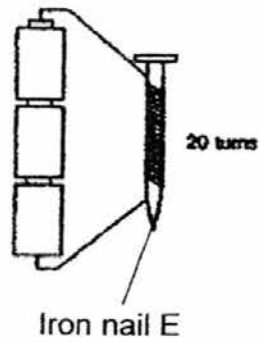

If the electromagnet with Iron nail E attracted 10 paper clips, what would be the number of paper clips attracted by the electromagnet with Aluminium nail F? Explain your answer. [1]

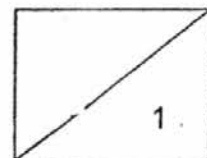

YEAR : 2016
 LEVEL : PRIMARY 4
 SCHOOL : TEMASEK PRIMARY
 SUBJECT : SCIENCE
 TERM : SA2

Booklet A

Q1	2	Q5	3	Q9	3	Q13	4	Q17	3	Q21	2	Q25	3
Q2	3	Q6	2	Q10	1	Q14	2	Q18	3	Q22	3	Q26	3
Q3	1	Q7	1	Q11	2	Q15	2	Q19	4	Q23	4	Q27	2
Q4	3	Q8	3	Q12	4	Q16	4	Q20	4	Q24	2	Q28	3

Booklet B

Q29

(a)



(b) A shadow is formed when light is blocked by an opaque object.

Q30

(a) digestion first takes place : 1

(b) there is no digestion : 4

Q31

Life cycle X	Life cycle Y
Butterfly	Cockroach
Mosquito	

Q32

	Statement	True	False
(a)	A piece of aluminium can be magnetized by passing electricity through it.		✓
(b)	A small magnet always has a weaker magnetic force than a larger magnet.		✓
(c)	The magnetic force of a magnet is the strongest at its poles.	✓	

- Q33
- (a) Block B has a greater volume than block A.
 - (b) It has a definite volume.
 - (c) Block A gained heat from the flame and expanded allowing A mass to increase.
- Q34
- (a) Jar A would be lower than Jar B / Jar A will go down.
 - (b) 200 cm^3
 - (c) Property 1: Air can be compressed.
Property 2: Air has mass / Air has no definite volume.
- Q35
- (a) The mass of the growing seed increases as the growing seed develop more leaves and roots.
 - (b) Seed coat.
 - (c) Yes. The young plant has leaves so it can make its own food.
- Q36(i)
- (a) Flask

Y

 Flask

X

 - (b) The plant in flask Y have roots therefore more water is absorbed while the plant in flask X has no roots so lesser water is absorbed.
- Q36(ii)
- (a) 5
 - (b) The greater the distance between the beaker and the lamp, the lesser air bubble was released per minute.
- Q37
- (a) Sheets P and Q are both transparent.
 - (b) Nothing would happen to the shadow as the removal of sheet 5 does not affect the set up above.

- Q38
- (a) Point B.
 - (b) Light travels in a straight line and cardboard is opaque and is blocking the other points while the hole allows the light to enter and shine on point B.
 - (c)
 - (i) The toy dinosaur is an opaque object and block all light.
 - (ii) The size of the dinosaur's shadow will be smaller but sharper.
- Q39
- (a) Put the ice cubes into cup P and pour hot water in the basin.
 - (b) Cup P would lose heat and contract while cup Q will gain heat and expand.
- Q40
- (a) Joseph wanted to find out if the water will gain heat or lose heat.
 - (b) The temperature of water will rise. As the L-shaped metal transport heat to the water, the water will gain heat.
 - (c) Metal is a good conductor of heat / Heat travels from a hotter region to a colder region.
- Q41
- (a) To transport food from the mouth to the stomach.
 - (b) Digestive juices.
 - (c)

D

A

C

- Q42
- (a) Suggestion 1 : Coil more wire in set up A.
 - (b) Suggestion 2 : Take one battery from set-up A or B.
 - (c) 0. Aluminium is a non-magnetic material and will not attract any paper clips.