



NANYANG PRIMARY SCHOOL

**SECOND SEMESTRAL ASSESSMENT
2019**

PRIMARY 4

**MATHEMATICS
(BOOKLET A)**

Total Duration for Booklets A and B: 1 hour 45 minutes

Additional materials: Optical Answer Sheet (OAS)

INSTRUCTIONS TO PUPILS

1. Do not turn over this page until you are told to do so.
2. Follow all instructions carefully.
3. Answer all questions.
4. Shade your answers in the Optical Answer Sheet (OAS) provided.

Name: _____ .()

Class: Primary 4 ()

Questions 1 to 15 carry 2 marks each. For each question, four options are given. One of them is the correct answer. Make your choice (1, 2, 3 or 4) and shade your answer on the Optical Answer Sheet. (30 marks)

1. Fifty-four thousand and seventy-two in figures is _____.
- (1) 54 720
 - (2) 54 702
 - (3) 54 072
 - (4) 5472
2. Which of the following numbers when rounded to the nearest ten becomes 61 500?
- (1) 61 444
 - (2) 61 496
 - (3) 61 506
 - (4) 61 554
3. Which of the following is a multiple of both 4 and 5?
- (1) 9
 - (2) 24
 - (3) 35
 - (4) 40

4. How many one-thirds are there in 4 wholes?

(1) $\frac{3}{4}$

(2) $\frac{4}{3}$

(3) 3

(4) 12

5. In which of the following numbers does the digit 5 stand for 5 tenths?

(1) 13.25

(2) 35.68

(3) 41.52

(4) 57.94

6. In the figure below, which angle is smaller than a right angle?

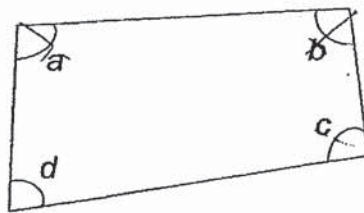

(1) $\angle a$

(2) $\angle b$

(3) $\angle c$

(4) $\angle d$

7. In a game show, Mei scored 4000 points. Ling scored 1002 fewer points than Mei. Ken scored 6 times as many points as Ling. How many points did Ken score?

(1) 17 448

(2) 17 988

(3) 18 012

(4) 30 012

8. Ahmad and Ravi had a total of 5656 picture cards at first. Ahmad had 7 times as many picture cards as Ravi. Ravi then lost 50 picture cards. How many picture cards did Ravi have in the end?

(1) 27

(2) 38

(3) 657

(4) 758

9. The mass of luggage P is 24.8 kg. Luggage P is 1.36 kg heavier than luggage Q. What is the mass of luggage Q?

(1) 11.20 kg

(2) 23.44 kg

(3) 23.56 kg

(4) 26.16 kg

10. Four boys took part in a race. The table below shows the time taken by the four boys.

Name	Time taken (s)
Albert	98
Bob	65
Colin	73
David	54

How much faster was the fastest runner in the race compared to Bob?

- (1) 11 s
(2) 33 s
(3) 54 s
(4) 98 s
11. The perimeter of a rectangular cardboard is 160 cm. The length of the cardboard is 48 cm. Find its breadth.

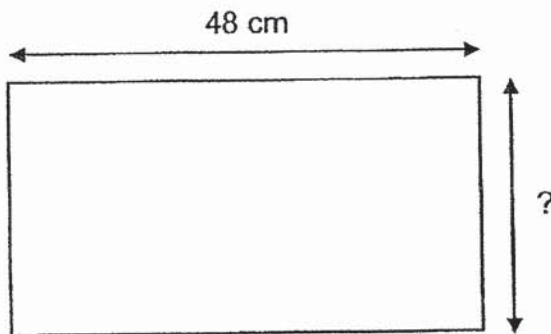

- (1) 32 cm
(2) 64 cm
(3) 96 cm
(4) 112 cm

12. The table below shows the 3-h PSI (Pollutant Standards Index) readings from 8 a.m. to 12 noon on 22 February.

Time	8 a.m.	9 a.m.	10 a.m.	11 a.m.	12 noon
3-h PSI	35	55	50	45	40

Which one of the line graphs below best represents the information in the table?

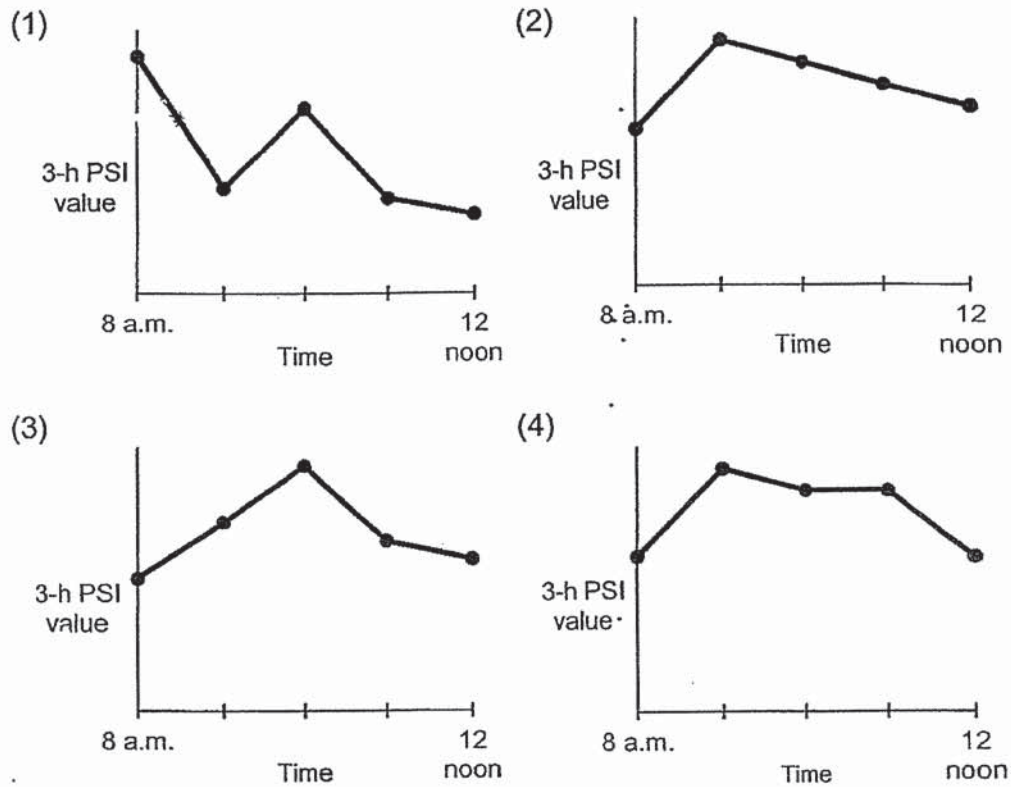

13. At a bakery, there were 525 blueberry cakes. The number of blueberry cakes was 3 times the number of peach cakes in the bakery. The number of lemon cakes was 758 more than the number of peach cakes. All the lemon cakes were packed into boxes for delivery. Each box could hold up to 5 lemon cakes. What was the smallest number of boxes needed to pack all the lemon cakes?

- (1) 186
- (2) 187
- (3) 466
- (4) 467

14. The table below shows the height of a plant in centimetres on the first day of each month from July to October.

Date	Height (cm)
1 st July	2.2
1 st August	6.8
1 st September	11.0
1 st October	21.1

In which month did the plant's height increase the most?

- (1) July
- (2) August
- (3) September
- (4) October

15. Khairi was given a monthly allowance of \$200 at the beginning of each month. He spent the monthly allowance on food, transportation and donation.

The line graph below shows how much he had left at the end of each week in February.

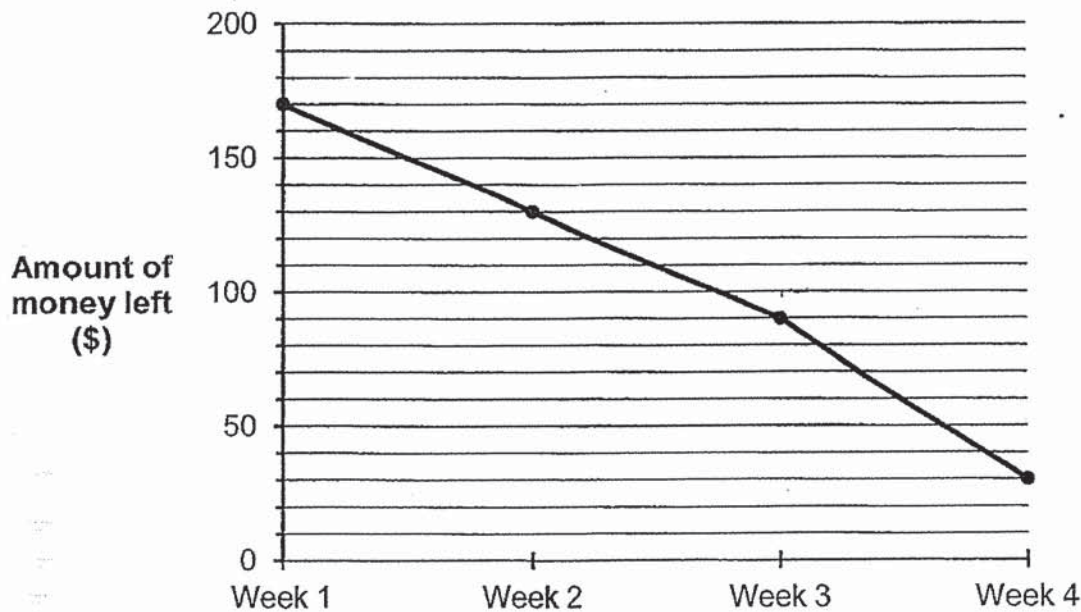

The table below shows the total amount of money Khairi spent on food and transportation from week 1 to week 4 in February.

Week	1	2	3	4
Total amount of money spent on food and transportation	\$20	\$30	?	\$50

He spent the same amount of money on donation each week. What was the total amount of money he spent on food and transportation in week 3?

- (1) \$30
- (2) \$40
- (3) \$60
- (4) \$90



NANYANG PRIMARY SCHOOL

**SECOND SEMESTRAL ASSESSMENT
2019**

PRIMARY 4

**MATHEMATICS
(BOOKLET B)**

Total Duration for Booklets A and B: 1 hour 45 minutes

INSTRUCTIONS TO PUPILS

1. Do not turn over this page until you are told to do so.
2. Follow all instructions carefully.
3. Answer all questions.
4. Write your answers in this booklet.

Name: _____ ()

Class: Primary 4 ()

Parent's Signature: _____

Booklet A	/ 30
Booklet B	/ 70
Total	/ 100

Any query on marks awarded should be raised by 1 November 2019. We seek your understanding in this matter as any delay in the confirmation of marks will lead to delays in the generation of results.

Questions 16 to 35 carry 2 marks each. Show your working clearly and write your answers in the spaces provided. For questions which require units, give your answers in the units stated. (40 marks)

16. What is the remainder when 2019 is divided by 8?

Ans: _____

17. In the figure below, square ABCD is made up of 9 unit squares. What fraction of square ABCD is shaded?

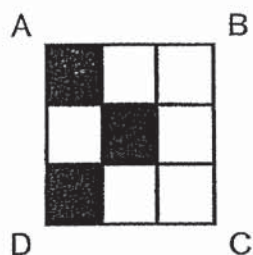

Ans: _____

18. $\frac{2}{3} + \frac{1}{6} =$ _____

Ans: _____

19. Write $\frac{15}{7}$ as a mixed number.

Ans: _____

20. Arrange the following numbers from the smallest to the greatest.

$$\frac{2}{5}, \quad 0.405, \quad 0.045$$

Ans: _____ , _____ , _____
(smallest) , (greatest)

21. Write 7 thousandths as a decimal.

Ans: _____

22. Write the decimal represented by A.

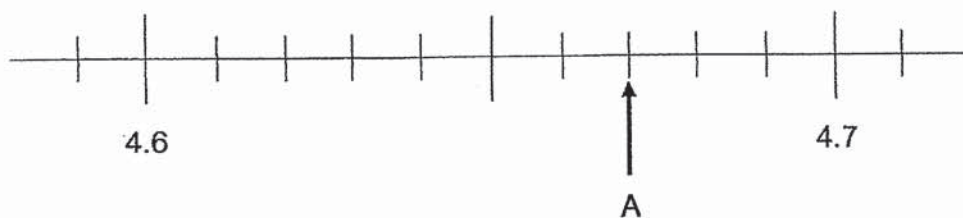

Ans: _____

23. $4.8 - 0.37 =$ _____

Ans: _____

24. Measure and write down the size of $\angle x$.

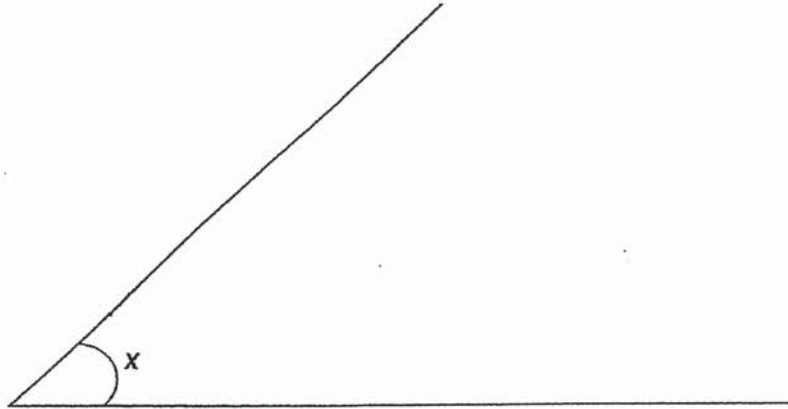

Ans: _____^o

25. The area of a square mat is 64 m^2 . Find its length.

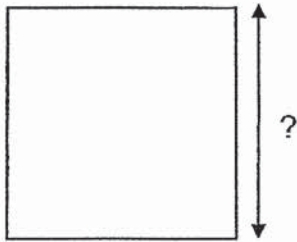

Ans: _____ m

26. In the square grid below, line JK and five points are given. One of the five given points is point L. $\angle JKL$ is greater than 45° but smaller than 90° . Draw line KL to complete $\angle JKL$.

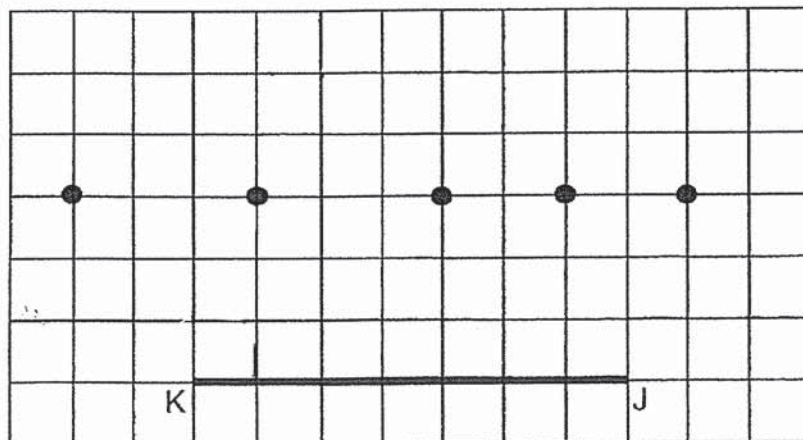

27. It is 8.30 a.m. now. What time will it be after the minute hand makes a three-quarter turn clockwise?

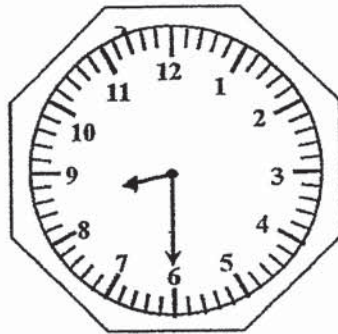

Ans: _____ a.m.

28. Sharon and Euan are standing in the middle of a town. Sharon is facing the MRT station and Euan is facing west. Sharon makes a $\frac{1}{2}$ turn. How many degrees in the anti-clockwise direction must Euan turn in order to face the same place as Sharon?

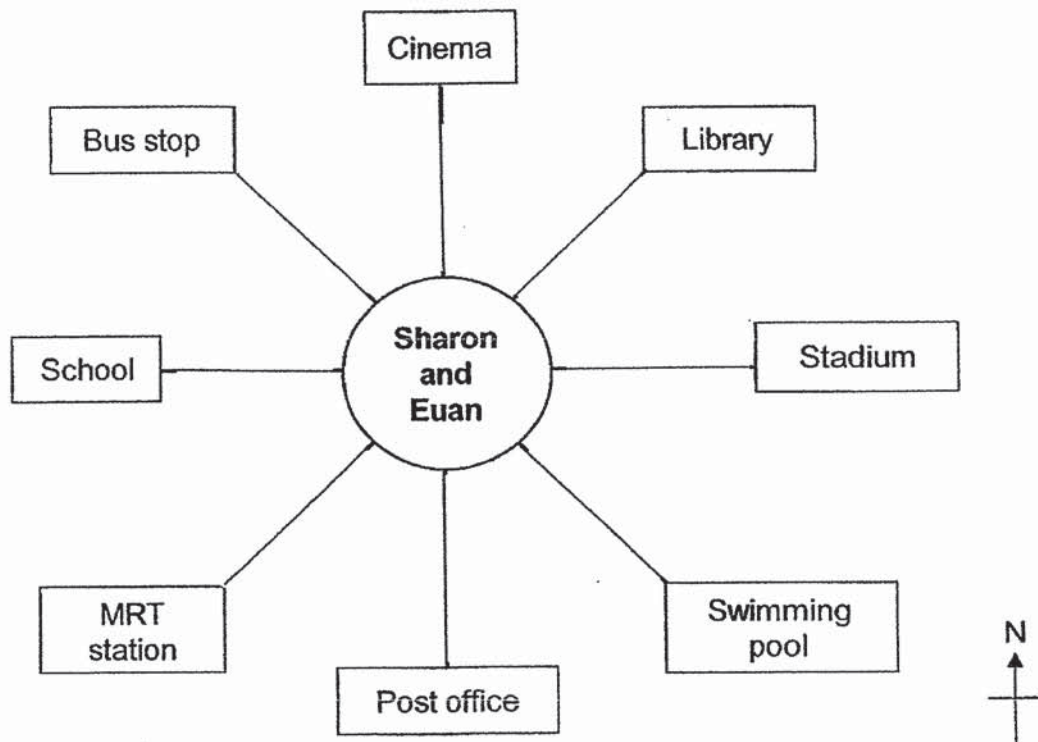

Ans: _____ °

29. In the figure below, EFGH is a rectangle.

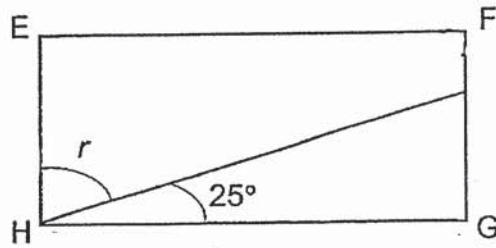

Each statement below is either true, false or not possible to tell from the information given. For each statement, put a (✓) in the correct column.

Statement	True	False	Not possible to tell
$\angle r = 75^\circ$			
The total length of EF and FG is equal to the total length of HG and EH.			

- 30.) In the square grid below, line AB forms one side of square ABCD.

(a) Complete the drawing of square ABCD and

(b) using the same line CD, draw a rectangle CDEF where line CD forms one side of rectangle CDEF and the length of line BC is 9 units.

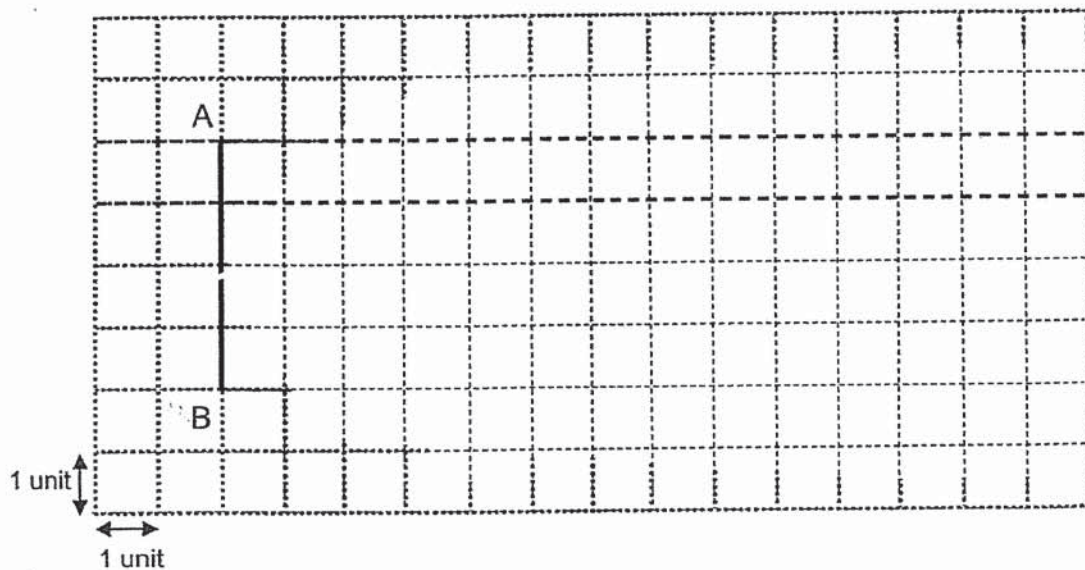

31. Complete the symmetric figure below using line PQ as the line of symmetry.

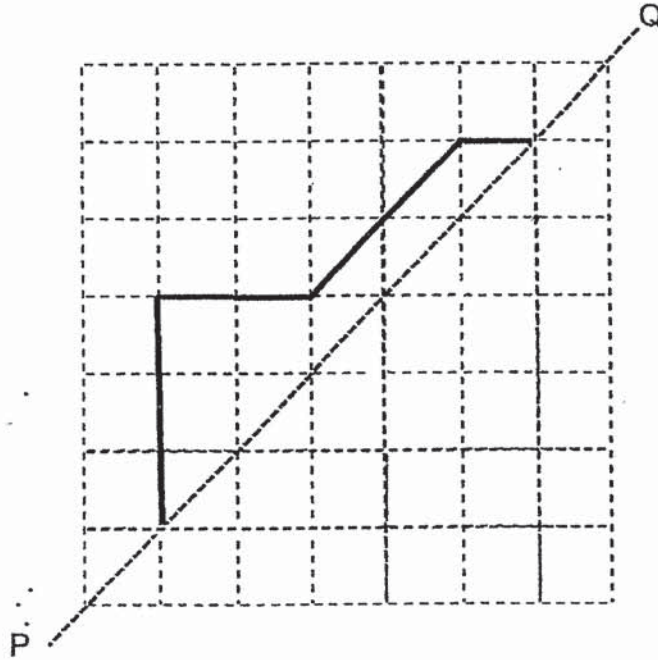

32. Mdm Rosie drank $\frac{2}{5}$ ℓ of iced lemon tea. Mrs Lee drank $\frac{1}{4}$ ℓ more iced lemon tea than Mdm Rosie. How much iced lemon tea did both of them drink altogether?

Ans: _____ ℓ

33. A tank was completely filled with water at 7 a.m. Water flowed out of the tank from 7 a.m. to 11 a.m.

The line graph below shows the volume of water in the tank at each 1-hour interval from 7 a.m. to 11 a.m.

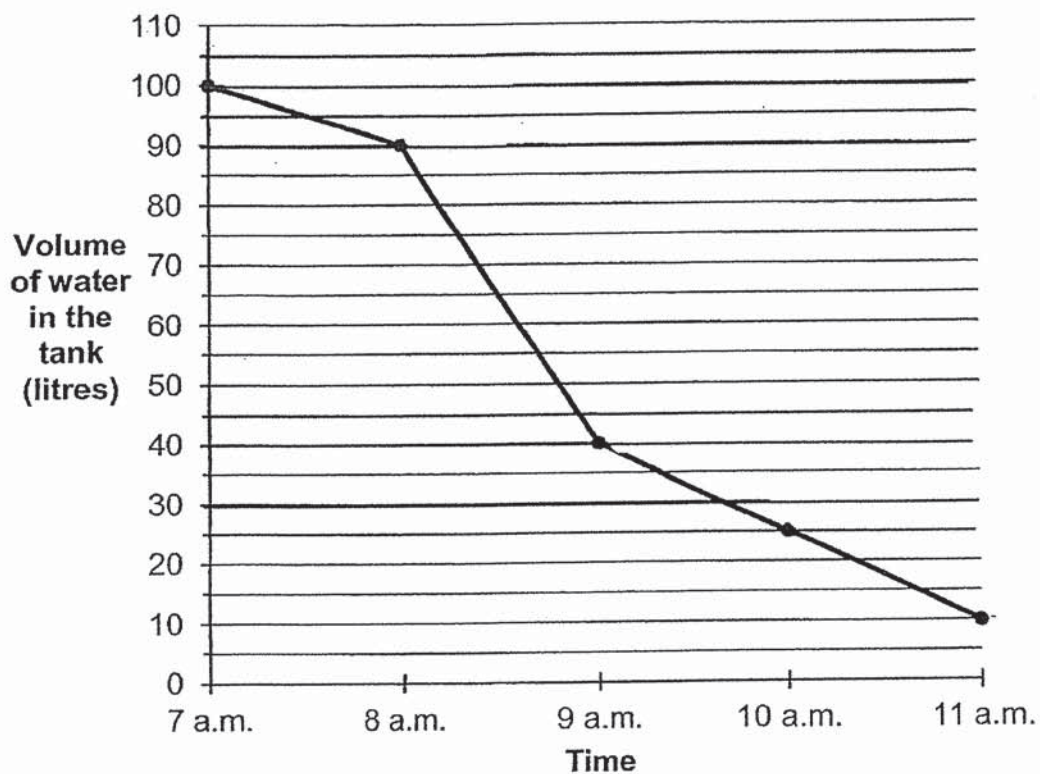

At what time was $\frac{1}{4}$ of the tank filled with water?

Ans: _____ a.m.

34. At first, there were some beads in a container. Aishah removed 258 beads from the container. Bala removed 10 times as many beads as Aishah from the container. There were 5788 beads in the container in the end. How many beads were there in the container at first?

Ans: _____

35. The figure below is made up of 4 identical rectangles. Find the perimeter of the figure.

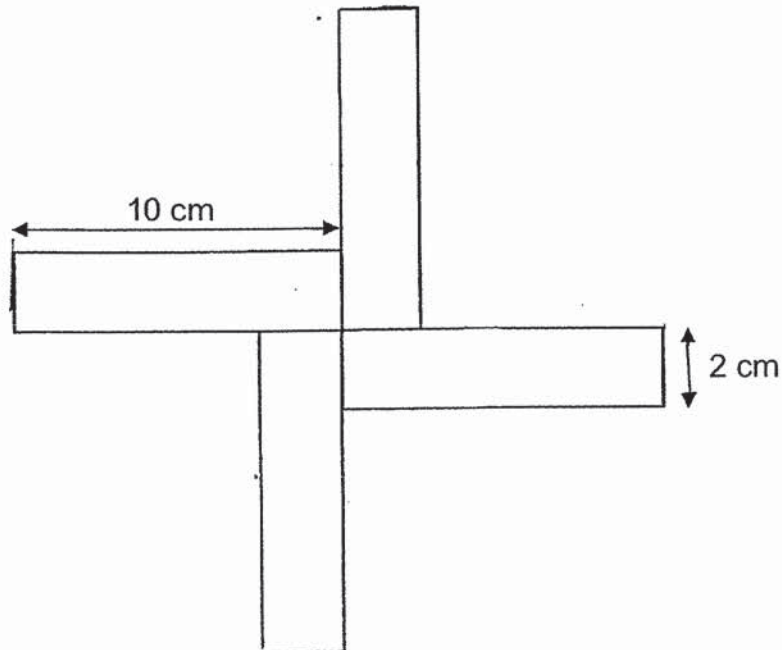

Ans: _____ cm

For questions 36 to 43, show your working clearly and write your answers in the spaces provided. The number of marks available is shown in brackets [] at the end of each question or part-question. (30 marks)

36. Laura had 1 m of wire. She gave 0.64 m of the wire to Trevor and the remaining wire to Kathy. Trevor used the wire he received to form a square, with no leftover. Kathy used the wire she received to form a triangle of equal sides, with no leftover. What was the difference in length between one side of the square and one side of the triangle?

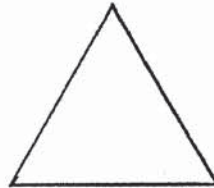
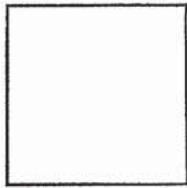

Ans: _____ [3]

37. Mavis started cycling at 08 15. Siti started cycling 10 minutes later but stopped cycling 10 minutes earlier than Mavis. Mavis stopped cycling at 10 20. How long did Siti cycle?

Ans: _____ [3]

38. The measurements of a plot of land are given below.
(All sides of the plot of land meet at right angles.)

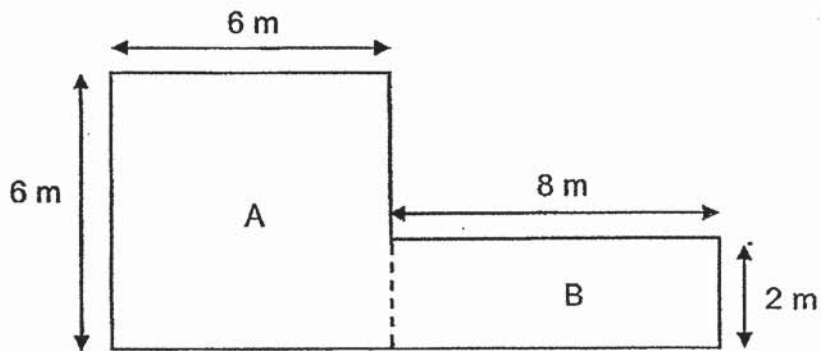

- (a) What is the area of the plot of land?
- (b) Each square metre of land costs \$85. How much does the plot of Land cost?

Ans: (a) _____ [2]

(b) _____ [2]

39. Mr Yap sold chicken sandwiches and tuna sandwiches from Monday to Thursday.

The table below shows the number of chicken sandwiches and tuna sandwiches sold in a certain week.

Day	Chicken Sandwich		Tuna Sandwich	
	Number sold	Amount collected	Number sold	Amount collected
Monday	9	\$27	45	\$90
Tuesday	30	\$90	25	\$50
Wednesday	50	\$150	60	\$120
Thursday	12	\$36	10	\$20

- (a) Each chicken sandwich was sold at the same price. How much did Mr Yap sell one chicken sandwich for?
- (b) How much more did he collect from the sales of chicken sandwiches than tuna sandwiches on Thursday?

Ans: (a) _____ [2]

(b) _____ [2]

40. Mr Alkaff and Mrs Rouge bought toothbrushes at the prices shown below.

**SPECIAL OFFER ON
TOOTHBRUSHES!!**



HURRY!
While stocks
last!

Oral Z
2 for \$5.00

Darvey
3 for \$4.55

- (a) Mr Alkaff bought 6 Oral Z and 6 Darvey toothbrushes. How much did he pay in all?
- (b) Mrs Rouge bought an equal number of Oral Z and Darvey toothbrushes. She paid \$48.20 in total. How many toothbrushes did she buy altogether?

Ans: (a) _____ [2]

(b) _____ [2]

41. Josephine and Lin had 188 muffins altogether. Josephine and Balakrisnan had 548 muffins altogether. Balakrisnan had 4 times as many muffins as Lin. How many muffins did Josephine have?

Ans: _____ [4]

42. Amelia baked some cookies for her family. She gave $\frac{1}{4}$ of the cookies to her brother, $\frac{3}{8}$ of the cookies to her sister and kept the rest in a jar. She kept 144 cookies in the jar.

- (a) What fraction of the cookies were kept in the jar?
- (b) How many more cookies did Amelia give to her sister than to her brother?

Ans: (a) _____ [2]

(b) _____ [2]

43. There are 40 children in a hall. In the hall, each boy is given 1 balloon and each girl is given 3 balloons. The children are given 74 balloons in total.

(a) How many girls are there in the hall?

(b) How many boys are there in the hall?

Ans: (a) _____ [3]

(b) _____ [1]

End of Paper

ANSWER KEY

YEAR : 2019
LEVEL : PRIMARY 4
SCHOOL : NANYANG PRIMARY SCHOOL
SUBJECT : MATHEMATICS
TERM : SA2

SECTION A

Q1) 3

Q2) 2

Q3) 4

Q4) 4

Q5) 3

Q6) 4

Q7) 2

Q8) 3

Q9) 2

Q10) 1

Q11) 1

Q12) 2

Q13) 2

Q14) 3

Q15) 1

Q16) 3

Q17) $\frac{3}{9}$ or $\frac{1}{3}$

Q18) $\frac{5}{6}$

Q19) $2\frac{1}{7}$

Q20) $0.045, \frac{2}{5}, 0.405$

Q21) 0.007

Q22) 4.67

Q23) 4.43

Q24) 41 or 42 or 43

Q25) 8m

Q26)

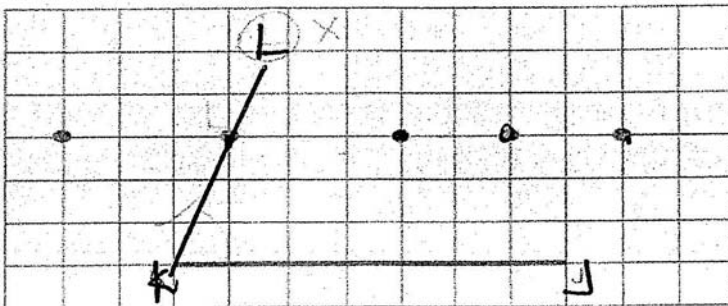

Q27) 9.15 a.m.

Q28) 225

Q29)

True	False	Not possible to tell
	✓	
✓		

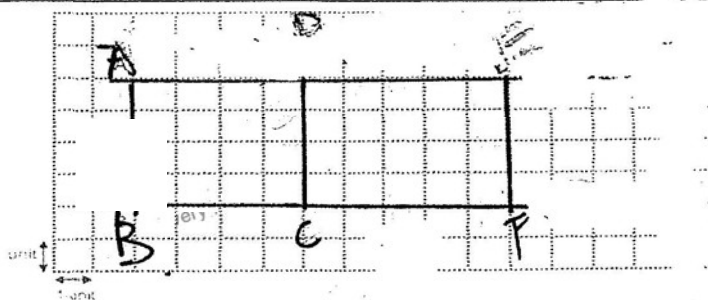

Q30)

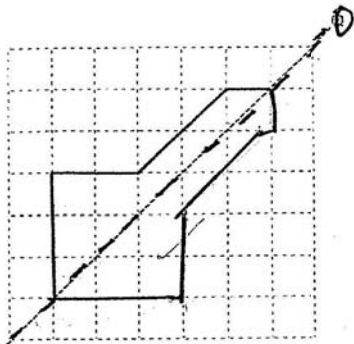

Q31)

P

Q32) $\frac{21}{20}$ or $1\frac{1}{20}$

Q33) 10 a.m.

Q34) 8626

Q35) 80cm

Q36) 0.04m or 4cm

Q37) 1h 45min or 105min

Q38) (a) 52m^2

(b) \$4420

Q39) (a) \$3

(b) \$16

Q40) (a) \$24.10

(b) 24

Q41) 68

Q42) (a) $\frac{3}{8}$

(b) 48

Q43) (a) 17

(b) 23

3

30 P.