

Name: \_\_\_\_\_ ( )

Class : Primary 4 \_\_\_\_\_

**CHIJ ST NICHOLAS GIRLS' SCHOOL (PRIMARY)****Primary 4 Mathematics****2020 End-Year Assessment****Booklet A****27 October 2020****TOTAL TIME FOR BOOKLETS A AND B: 1 HOUR 45 MINUTES**

Do not turn over this page until you are told to do so.  
Follow all instructions carefully.  
Answer all questions.

This booklet consists of 10 printed pages.



**Section A: (19 x 2 marks)**

For each question, four options are given. One of the options is the correct answer. Shade the correct oval (1, 2, 3 or 4) on the Optical Answer Sheet. Please use only 2B pencil and SHADE the oval completely.

---

1. The value of the digit 8 in 24 837 is \_\_\_\_\_.
- (1) 80  
(2) 800  
(3) 8000  
(4) 80 000
2. 11 thousands 5 tens is the same as \_\_\_\_\_.
- (1) 115  
(2) 1150  
(3) 11 005  
(4) 11 050
3. 62 759 rounded to the nearest hundred is \_\_\_\_\_.
- (1) 62 700  
(2) 62 760  
(3) 62 800  
(4) 63 000

4. Which of the following figures in the square grid below has both parallel lines and perpendicular lines?

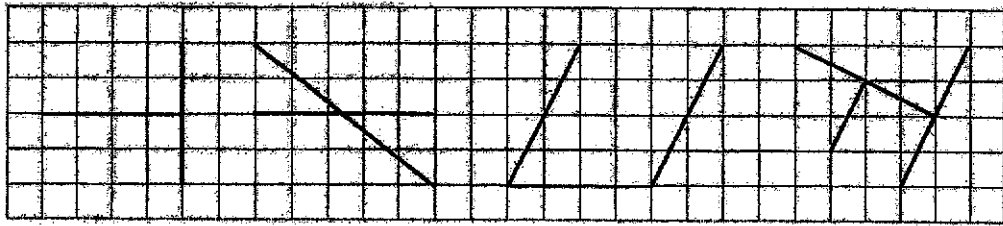

(1)

(2)

(3)

(4)

5. What fraction of the shapes in the box are  ?

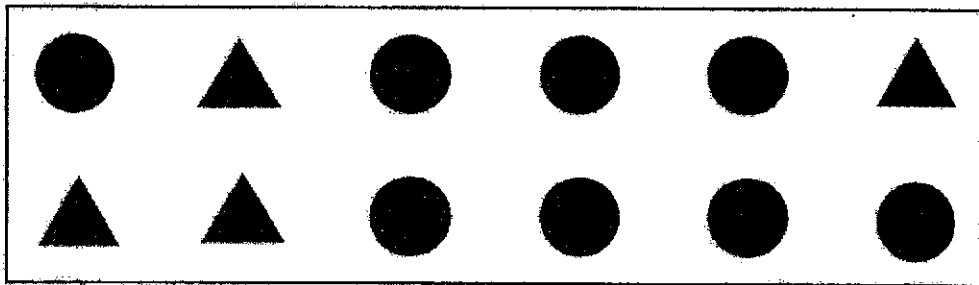

(1)  $\frac{4}{12}$

(2)  $\frac{4}{8}$

(3)  $\frac{8}{12}$

(4)  $\frac{8}{4}$

6. How many quarters are there in 2 wholes?

(1)  $\frac{2}{4}$

(2)  $\frac{8}{4}$

(3) 4

(4) 8

7. In the figure below, what is the length of the pencil in cm?

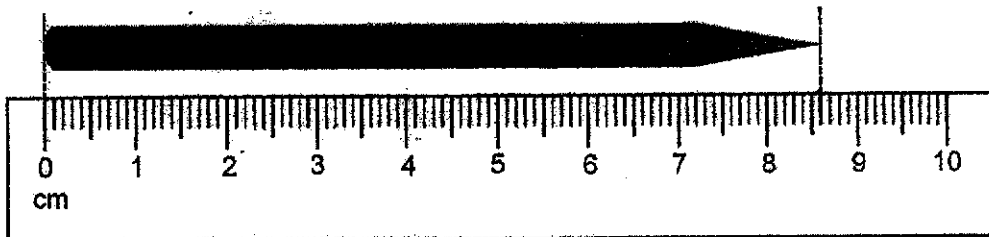

(1) 9.6 cm

(2) 9.4 cm

(3) 8.6 cm

(4) 8.4 cm

8. Which number below is 1.3 less than 4.78?

(1) 3.48

(2) 4.65

(3) 4.91

(4) 6.08

9. The bar graph below shows the number of storybooks read by Primary Four pupils in Sunshine Primary School.

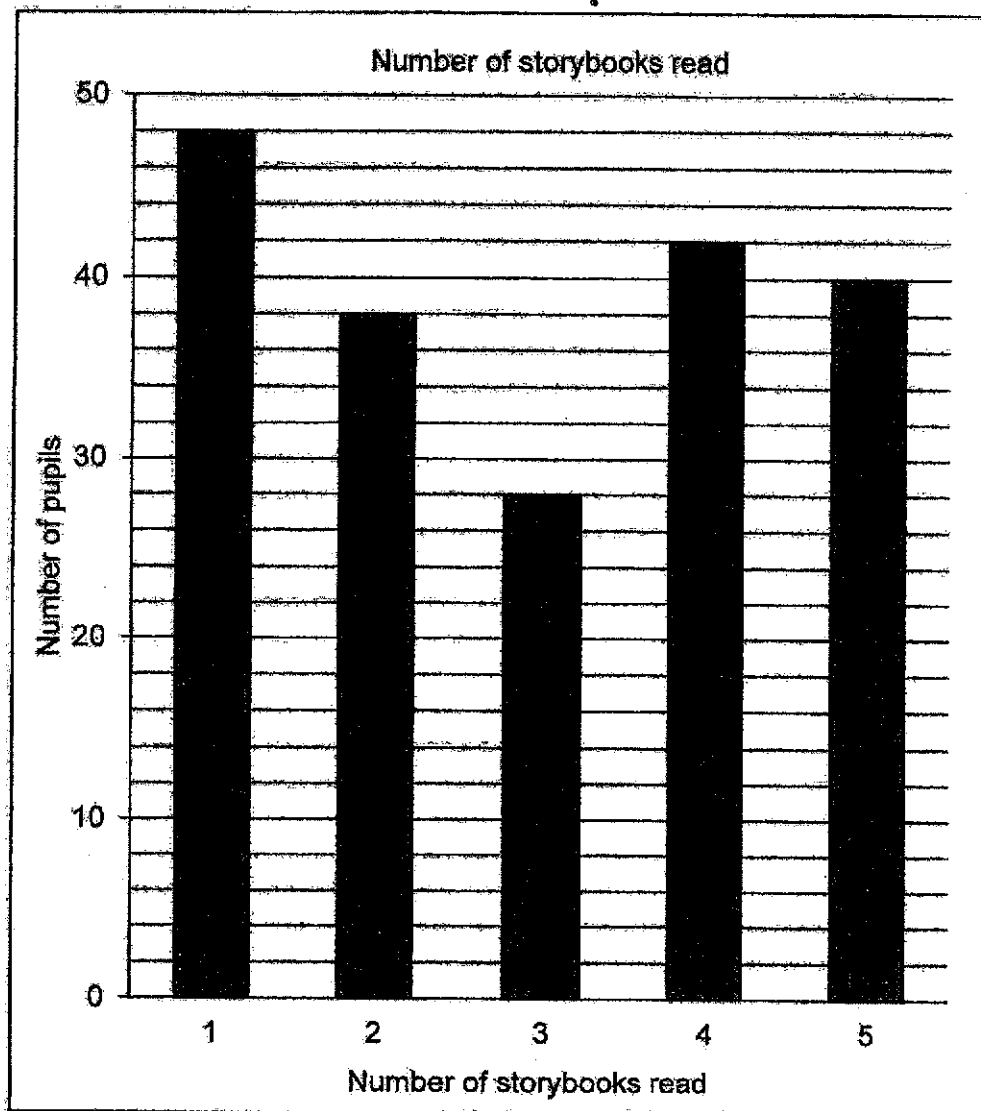

How many pupils read more than 3 books?

- (1) 82
- (2) 86
- (3) 110
- (4) 114

10. Cheryl bought some strawberries. She ate 28 strawberries and gave the remaining strawberries to her 6 friends. Each of her friends received 37 strawberries. How many strawberries did Cheryl buy?
- (1) 131
  - (2) 194
  - (3) 205
  - (4) 250
11. 6 identical bags and 3 identical shirts cost \$126. 3 such bags cost as much as 2 such shirts. What is the cost of one such shirt?
- (1) \$12
  - (2) \$14
  - (3) \$18
  - (4) \$42

12. At first, Pamela was standing at Point X facing the market. She turned in an anti-clockwise direction. She is facing the school now. What was the angle she turned?

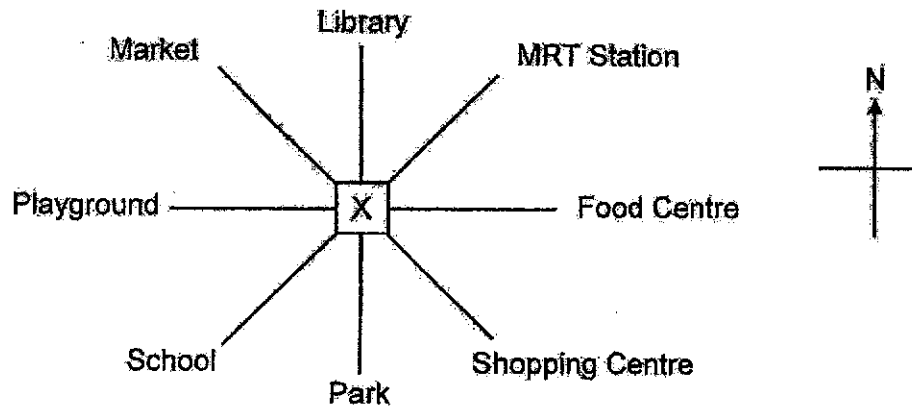

- (1)  $45^\circ$   
 (2)  $90^\circ$   
 (3)  $135^\circ$   
 (4)  $270^\circ$
13. Mr Lee baked some cupcakes. He sold  $\frac{4}{7}$  of the cupcakes and had 84 cupcakes left. How many cupcakes did he bake?

- (1) 36  
 (2) 48  
 (3) 147  
 (4) 196



14. Benny bought 8 buns. Each bun cost \$1.30. He gave the cashier some money and received a change of \$9.60. How much money did he give the cashier?

- (1) \$10.90
- (2) \$10.40
- (3) \$18.90
- (4) \$20.00

15. A ribbon of length 2.4 m is cut into 2 pieces. The longer piece is 4 times as long as the shorter piece. What is the length of the shorter piece?

- (1) 0.48 m
- (2) 0.60 m
- (3) 1.20 m
- (4) 1.92 m

16. The square has a side of 6 cm. The rectangle and the square have the same perimeter. The length of the rectangle is twice its breadth. Find the length of the rectangle.

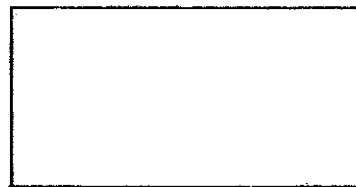
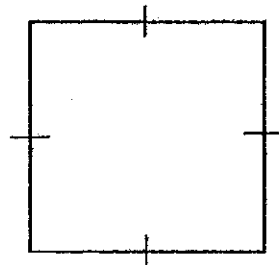

- (1) 4 cm
- (2) 8 cm
- (3) 16 cm
- (4) 24 cm

The line graph below shows the temperatures in Singapore for a particular day. Study the graph carefully and answer questions 17 and 18.

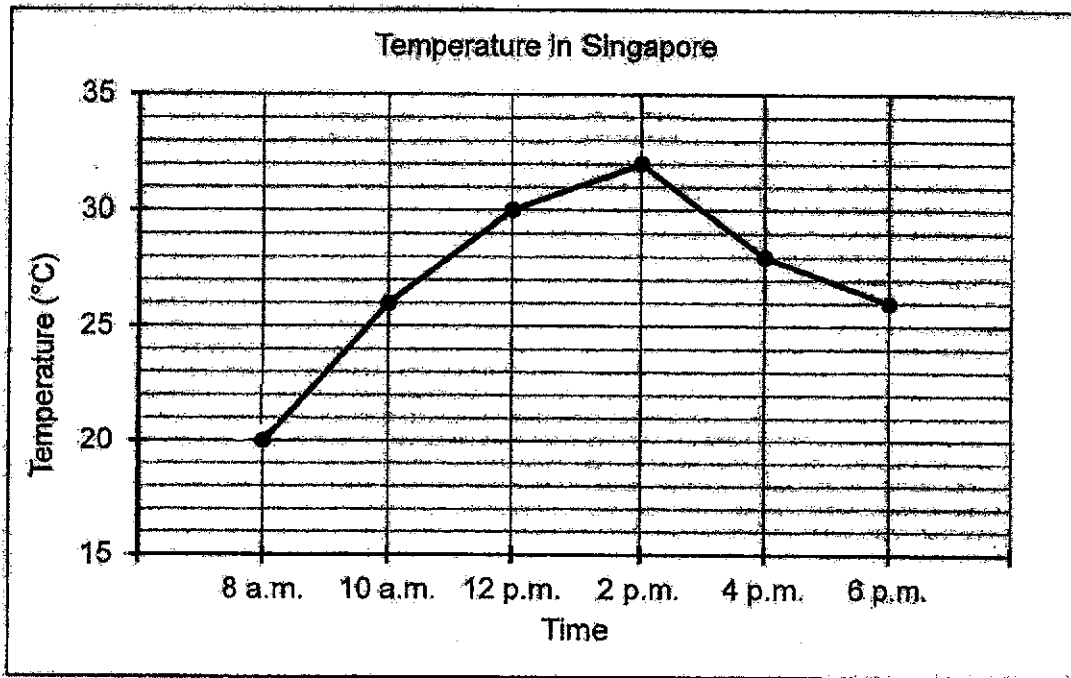

17. During which 2-hour interval did the temperature decrease the most?
- (1) 8 a.m. to 10 a.m.
  - (2) 10 a.m. to 12 p.m.
  - (3) 2 p.m. to 4 p.m.
  - (4) 4 p.m. to 6 p.m.
18. What is the difference between the highest temperature and the lowest temperature?
- (1) 6 °C
  - (2) 12 °C
  - (3) 20 °C
  - (4) 32 °C

19. At first, Ahmad was standing at one of the points shown in the grid. Then, he walked 3 steps to the South, 2 steps to the East and 1 step to the North. He ended up at point H. At which point was he standing at first?

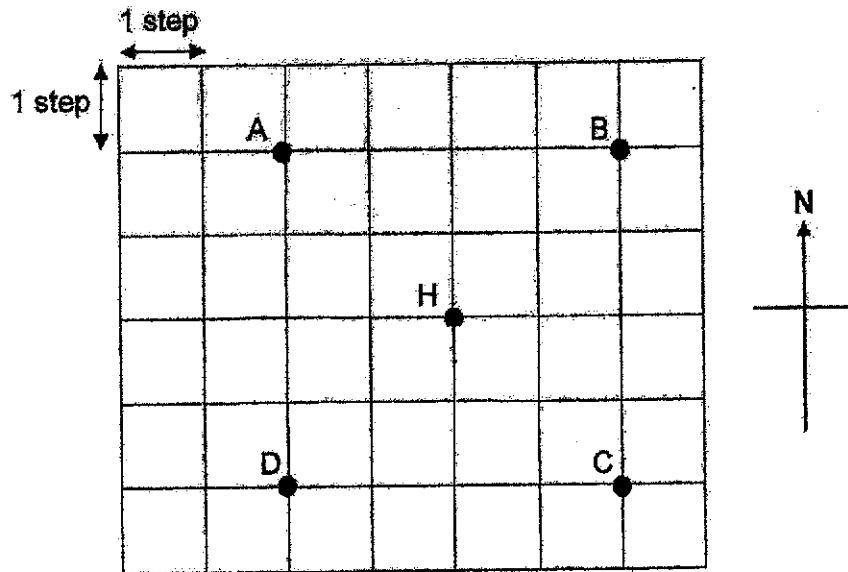

- (1) A
- (2) B
- (3) C
- (4) D

~ End of Booklet A ~

Name: \_\_\_\_\_ ( )

Class : Primary 4 \_\_\_\_\_

**CHIJ ST NICHOLAS GIRLS' SCHOOL (PRIMARY)**

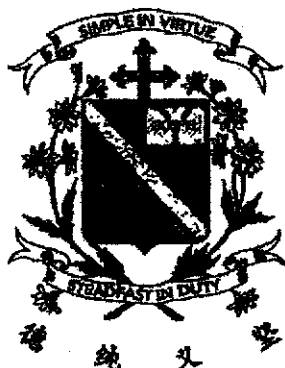

**Primary 4 Mathematics**

**2020 End-Year Assessment**

**Booklet B**

**27 October 2020**

<b>Booklet A :</b>	<b>/ 38</b>
<b>Booklet B :</b>	<b>/ 62</b>
<b>Total :</b>	<b>/ 100</b>

\_\_\_\_\_  
Parent's

**TOTAL TIME FOR BOOKLETS A AND B: 1 HOUR 45 MINUTES**

Do not turn over this page until you are told to do so.  
Follow all instructions carefully.  
Answer all questions.

This booklet consists of 17 printed pages.

**Section B: (20 x 2 marks)**Do not write  
in this space

Write down your answers in the spaces provided. For questions which require units, give your answers in the units stated. Show all workings clearly.

20. What is the remainder when 1358 is divided by 9?

Ans : \_\_\_\_\_

21. Measure and write down the size of  $\angle x$ .

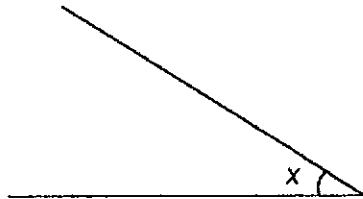

Ans : \_\_\_\_\_ °



22. Write  $\frac{22}{8}$  as a mixed number.

Do not write  
in this space

Ans : \_\_\_\_\_

23. Write 7 thousandths as a decimal.

Ans : \_\_\_\_\_



24.

The line graph below shows the amount of money Amos received from selling food.

Do not write in this space

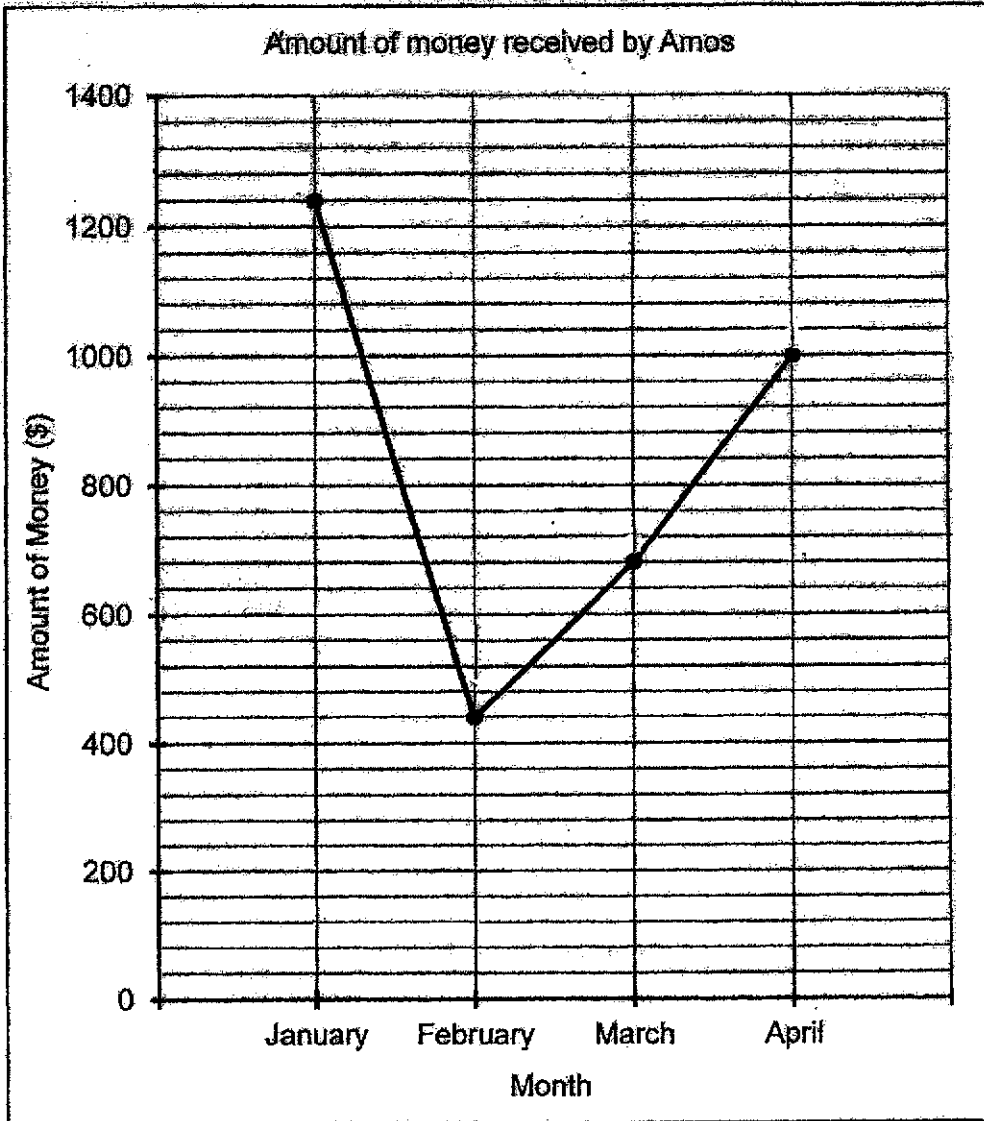

How much money did Amos receive altogether from January to April?

Ans : \$ \_\_\_\_\_



25. Find the perimeter of the figure below. All the lines meet at right angles.

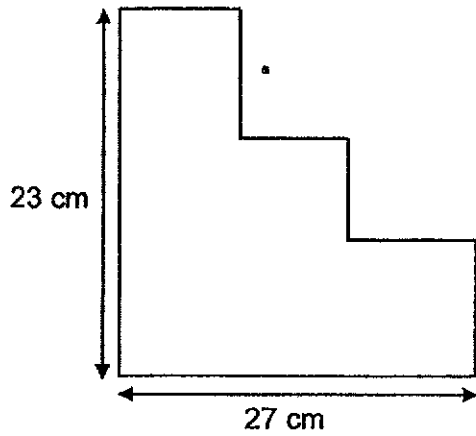

Do not write  
in this space

Ans : \_\_\_\_\_ cm

26. A picture is mounted on a frame measuring 26 cm by 34 cm. Find the area of the picture.

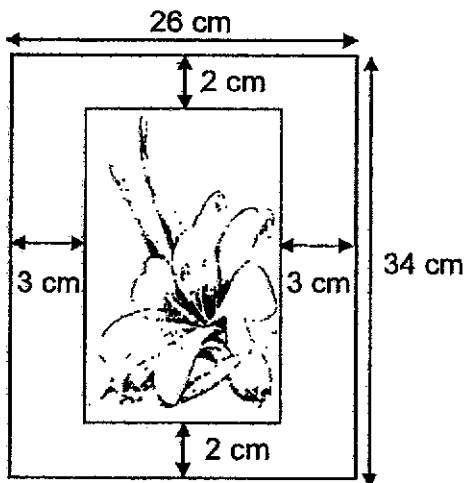

Ans : \_\_\_\_\_ cm<sup>2</sup>

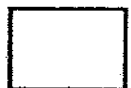



27. The figure below is made up of 4 similar rectangles. The breadth of each rectangle is 7 cm. Find the area of the figure.

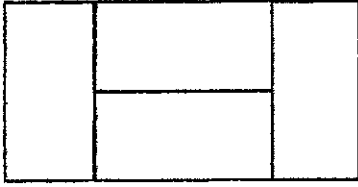

Do not write  
in this space

Ans : \_\_\_\_\_ cm<sup>2</sup>

28. Arrange the following numbers from the smallest to the greatest.

$$\frac{2}{5}, 0.402, 0.042$$

Ans : \_\_\_\_\_ , \_\_\_\_\_ , \_\_\_\_\_  
(smallest) (greatest)



29. Write the decimal represented by A.

Do not write  
in this space

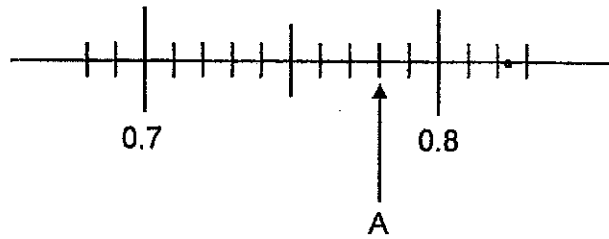

Ans : \_\_\_\_\_

30. Jane had 3 m of ribbon. She gave her mother 0.6 m of the ribbon and cut the remaining ribbon into 4 equal pieces. How long was each piece of ribbon?

Ans : \_\_\_\_\_ m



31. Which two of the fractions below are smaller than  $\frac{1}{2}$ ?

$\frac{3}{4}$  ,  $\frac{4}{9}$  ,  $\frac{4}{8}$  ,  $\frac{3}{10}$

Do not write  
in this space

Ans : \_\_\_\_\_ and \_\_\_\_\_

32. In the figure below, rectangle ABCD is made up of 8 unit squares. What fraction of rectangle ABCD is shaded?

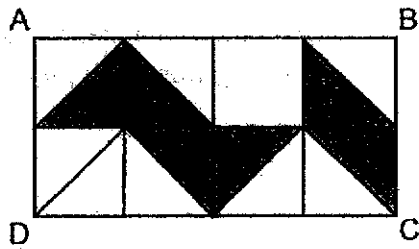

Ans : \_\_\_\_\_



33. The dotted line in the figure below is a line of symmetry. Shade four squares to make the figure symmetrical.

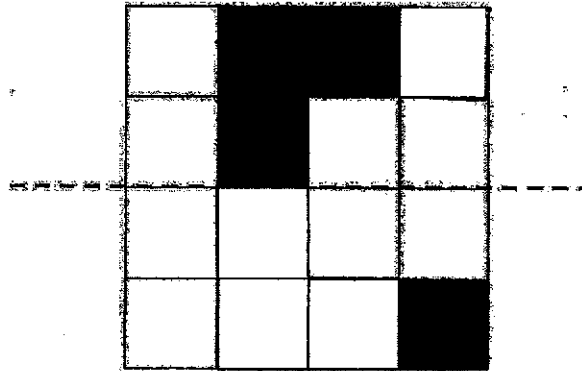

Do not write  
in this space

34. In the figure below, name the two angles that are smaller than  $90^\circ$ .

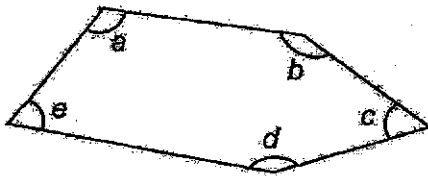

Ans : \_\_\_\_\_ and \_\_\_\_\_

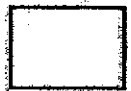

The table below shows the number of plates of chicken rice and fried noodles sold in the school canteen from Monday to Friday. Study the table carefully and answer questions 35 and 36.

Do not write  
in this space

Day	Number of plates sold		Total number of plates sold
	Chicken Rice	Fried Noodles	
Monday	24	65	89
Tuesday	?	?	60
Wednesday	62	33	95
Thursday	76	22	98
Friday	16	61	77

35. On which 2 days were there a total number of 175 plates of chicken rice and fried ~~rice~~ sold?  
Noodles

Ans : \_\_\_\_\_ and \_\_\_\_\_

36. On Tuesday, the number of plates of chicken rice sold was three times the number of plates of fried noodles sold. How many plates of fried noodles were sold on Tuesday?

Ans : \_\_\_\_\_



37. —Some factors of 32 are 1, 2, 4 and 32. What are the other two factors of 32?

Do not write  
in this space.

Ans : \_\_\_\_\_ and \_\_\_\_\_

38. Alicia, Brahim and Chitra had 560 stickers. Brahim had four times as many stickers as Alicia. Brahim had 20 fewer stickers than Chitra. How many stickers did Alicia have?

Ans : \_\_\_\_\_

39. Sharifah participated in a mathematics quiz that consisted of 10 questions. For every correct answer, she was awarded 3 points. For every wrong answer, 2 points were deducted. Sharifah scored 15 points in the quiz. How many questions did she answer correctly?

Ans : \_\_\_\_\_



**Section C: (22 marks)**Do not write  
in this space

Solve the following problems. All mathematical working and statements must be shown clearly.

40. The figure below shows a square ABCD.  
Find the sum of  $\angle x$  and  $\angle y$ .

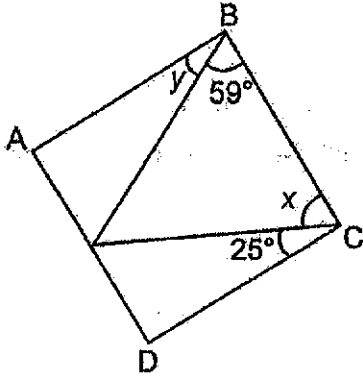

Ans : \_\_\_\_\_ [ 3 ]



41. Siti made some orange drink using water and orange syrup. She used  $\frac{3}{4}$  ℓ of water and  $\frac{1}{8}$  ℓ less syrup than water. How much orange drink did she make? Express your answer as a mixed number in the simplest form.

Do not write  
in this space

Ans : \_\_\_\_\_ [3]





42. The total mass of a container with 4 similar cupcakes was 237.2 g. After 2 cupcakes were removed, the total mass of the container and the remaining cupcakes was 169.6 g. What was the mass of each cupcake?

Do not write  
in this space.

Ans : \_\_\_\_\_ [4]



43. A rectangular piece of paper was folded to form the figure below.

Do not write  
in this space

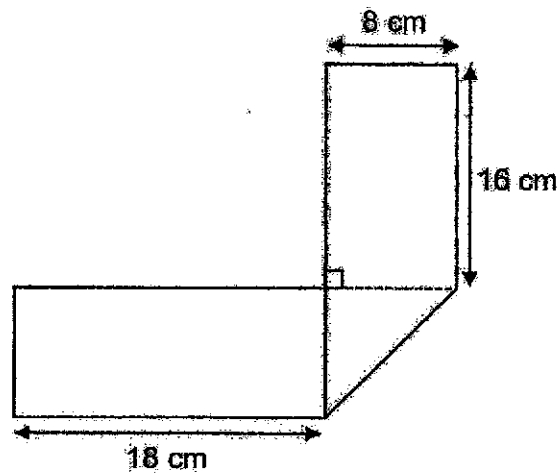

- (a) Find the length of the rectangular piece of paper before it was folded.  
 (b) Find the area of the rectangular piece of paper before it was folded.

Ans : (a) \_\_\_\_\_ [2]

(b) \_\_\_\_\_ [2]



44. Caili had 285 more marbles than Dinesh at first. After Caili bought another 75 marbles, she had 3 times as many marbles as Dinesh. How many marbles did Caili have in the end?

Do not write  
in this space

Ans : \_\_\_\_\_ [ 4 ]

45. One chair can be placed at each side of a square table. The tables and chairs are arranged as shown in the pattern below.

Do not write  
in this space

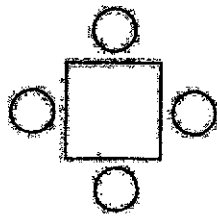

1 square table

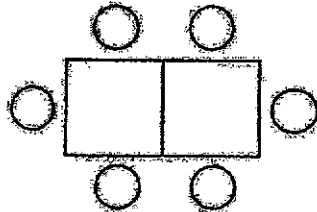

2 square tables

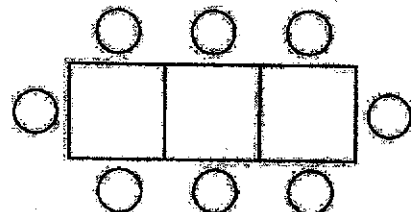

3 square tables

- (a) When 6 such tables are joined to form a long table, how many chairs can be placed at the long table?
- (b) How many tables are needed to place 24 chairs?

Ans : (a) \_\_\_\_\_ [ 2 ]

(b) \_\_\_\_\_ [ 2 ]



~ End of Paper ~

SCHOOL : CHIJ ST NICHOLAS GIRLS' SCHOOL  
 LEVEL : PRIMARY 5  
 SUBJECT : MATH  
 TERM : 2020 SA2

**PAPER 1 BOOKLET A**

Q 1	Q2	Q3	Q4	Q5	Q6	Q7	Q8	Q9	Q10
2	4	3	4	1	4	3	1	1	4

Q 11	Q12	Q13	Q14	Q15	Q16	Q17	Q18	Q19
3	2	4	4	1	2	3	2	1

**PAPER 1 BOOKLET B**

Q20)	8
Q21)	$32^\circ$
Q22)	$2\frac{6}{8}$
Q23)	0.007
Q24)	\$3360
Q25)	100cm
Q26)	$600\text{cm}^2$
Q27)	$392\text{cm}^2$
Q28)	$0.042, \frac{2}{5}, 0.402$
Q29)	$0.1 \div 10 = 0.01$
Q30)	0.6m
Q31)	$\frac{4}{9}$ and $\frac{3}{10}$
Q32)	$\frac{3}{8}$

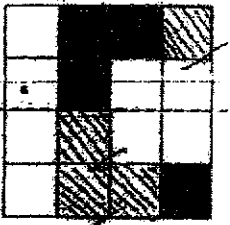
Q33)	
Q34)	E and C
Q35)	Friday and Thursday
Q36)	15
Q37)	8 and 16
Q38)	$560 - 20 = 540$ $540 \div 9 = 60$
	Ans: 60
Q39)	7

## SECTION C

Q40)	$90^\circ - 59^\circ = 31^\circ$ $90^\circ - 25^\circ = 65^\circ$ $65^\circ + 31^\circ = 96^\circ$
	Ans: $96^\circ$
Q41)	$\frac{3}{4} = \frac{6}{8}$ $\frac{6}{8} - \frac{1}{8} = \frac{5}{8}$ $\frac{5}{8} + \frac{6}{8} = 1\frac{3}{8}$
	Ans: $1\frac{3}{8}l$
Q42)	$c + 4cs \rightarrow 237.2g$ $c + 2cs \rightarrow 169.6g$ $237.2 - 169.6 = 67.6$ $67.6 \div 2 = 33.8$
	Ans: 33.8g
Q43)	<p>(a) <math>18 + 18 + 16 = 42cm</math></p> <p>(b) <math>42 \times 8 = 336cm^2</math></p>
Q44)	$285 + 75 = 360$ $360 \div 2 = 180$ $180 \times 3 = 540$
	Ans: 540
Q45)	<p>(a) <math>8 + 2 = 10</math></p> $10 + 2 = 12$ $12 + 2 = 14$
	Ans: 12
	(b) $22 + 2 = 24 11th$
	Ans: 11