



HENRY PARK PRIMARY SCHOOL
FIRST SEMESTRAL ASSESSMENT 2019
PRIMARY 4
SCIENCE
BOOKLET A (56 MARKS)

INSTRUCTIONS TO CANDIDATES

1. Do not turn over this page until you are told to do so.
2. Follow all instructions carefully.
3. Answer all questions.
4. Shade your answers on the Optical Answer Sheet (OAS) provided.

Name: _____ ()

Class: Primary 4 ()

Date: 22 May 2019

Total Time: 1 h 45 min

Booklet	Marks
A	/ 56
B	/ 44
Total (A+B)	/ 100

Parent's Signature:

Section A (56 marks)

For each question from 1 to 28, four options are given. One of them is the correct answer. Make your choice (1, 2, 3 or 4). Shade the correct oval (1, 2, 3 or 4) on the Optical Answer Sheet.

1. The diagram shows a boy wearing a helmet while riding his bicycle.

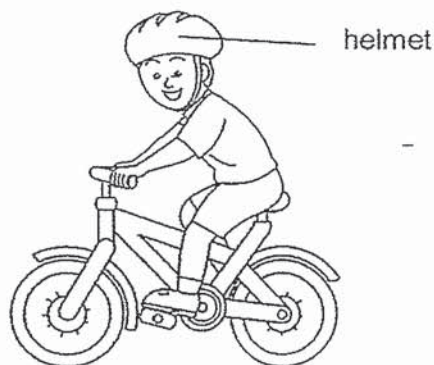

Which system in the human body performs the similar function as the helmet?

- (1) skeletal system
 - (2) digestive system
 - (3) muscular system
 - (4) respiratory system
2. Which of the following does **not** produce digestive juices?
- (1) mouth
 - (2) stomach
 - (3) small intestine
 - (4) large Intestine
3. Which system in the human body helps to take in oxygen from the surrounding air?
- (1) skeletal system
 - (2) digestive system
 - (3) circulatory system
 - (4) respiratory system

4. Which of the following represents the function(s) of the small intestine?

	Digestion of food	Absorption of digested food into blood	Absorption of water from undigested food into blood
(1)	✓	✓	✗
(2)	✗	✓	✗
(3)	✓	✓	✓
(4)	✗	✗	✓

5. The graph shows the amount of undigested food left in the various organs as it travelled through the digestive system.

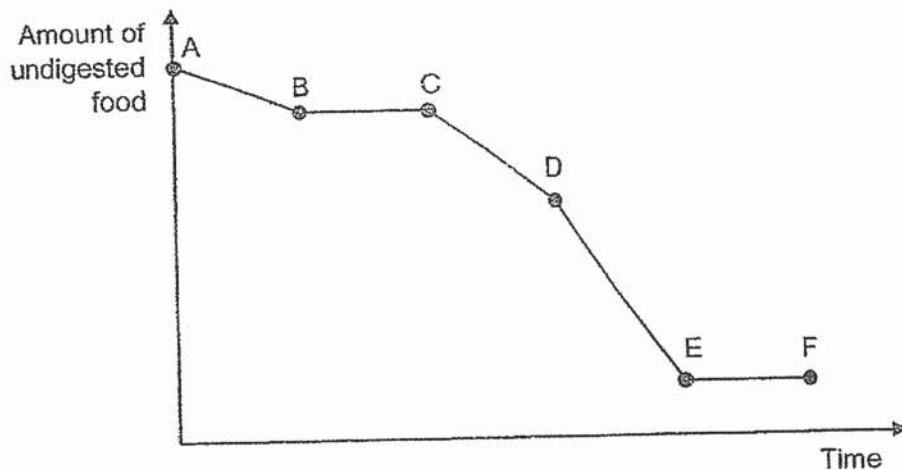

Which of the following shows correctly part of the graph representing the mouth and the small intestine?

	mouth	small intestine
(1)	AB	CD
(2)	BC	EF
(3)	BC	DE
(4)	AB	DE

6. The diagram shows a plant floating on a pond.

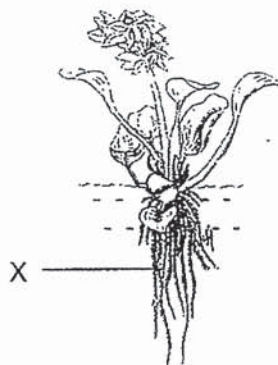

What is/are the function(s) of part X in this diagram?

- A Anchor the plant to the soil.
 - B Absorb water and nutrients.
 - C Transport water to all parts of the plant.
- (1) B only
(2) C only
(3) A and B only
(4) A and C only
7. Newly planted trees are usually tied to the ground as shown in the diagram. This is to prevent the tree from falling when there is a strong wind.

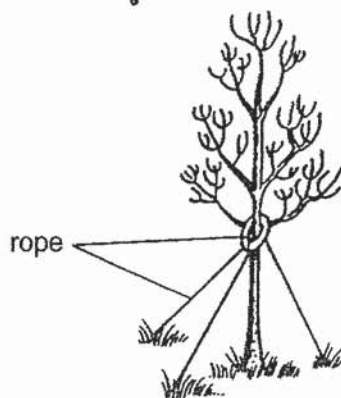

After some time, the rope is removed.

Why was the rope removed?

- (1) The tree is heavier and will not move.
- (2) The stem is able to hold the plant upright.
- (3) The branches are able to spread out more.
- (4) The roots are able to anchor the tree to the ground.

8. Melisa classified four things as shown.

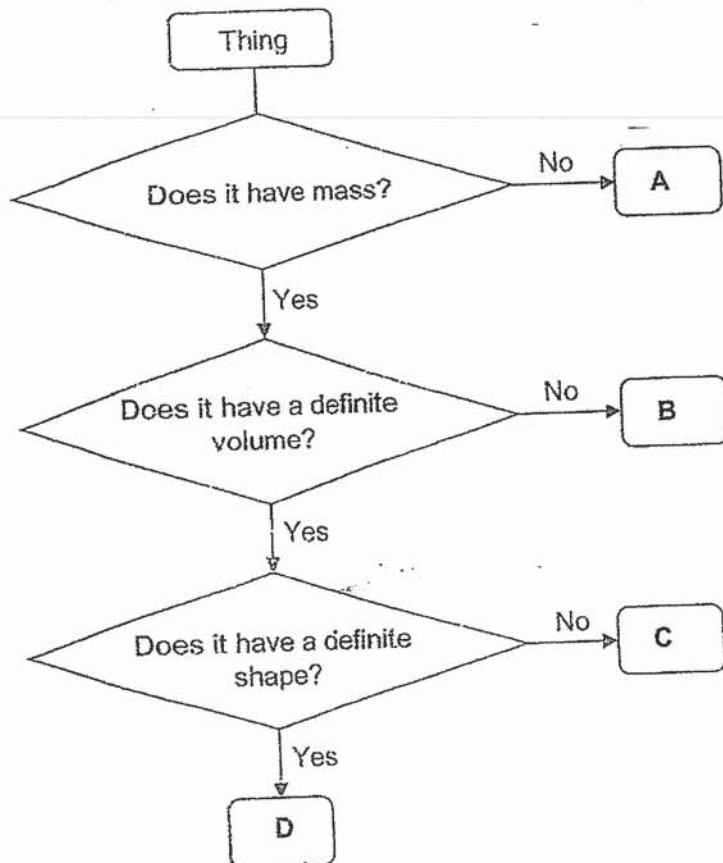

What could A, B, C and D be?

	A	B	C	D
(1)	air	ice	oxygen	syrup
(2)	music	juice	smoke	table
(3)	noise	oxygen	water	stone
(4)	shadow	sand	petrol	candle

9. Two syringes, P and Q, contain substances X and Y respectively. One end of each syringe is sealed.

The plunger in syringe P could **not** be pushed in while the plunger in syringe Q could be pushed in slightly as shown below.

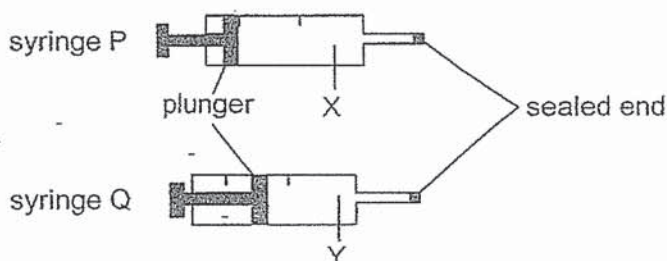

Which of the following substances are most likely to be X and Y?

	X	Y
(1)	air	water
(2)	oil	air
(3)	carbon dioxide	oxygen
(4)	water	oil

10. Ben poured some orange juice from a carton into container A. He then poured all the orange juice from container A into container B, and then into container C.

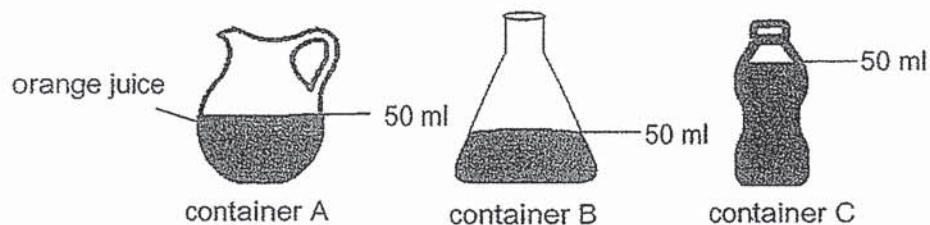

What can Ben conclude from his observation?

- (1) The orange juice takes the shape of each container.
- (2) The shape of the orange juice is always the same in each container.
- (3) The orange juice filled to the same level when poured into each container.
- (4) The mass of the orange juice was different when poured into different containers.

11. The classification table is used to classify oxygen, metal coin and milk.

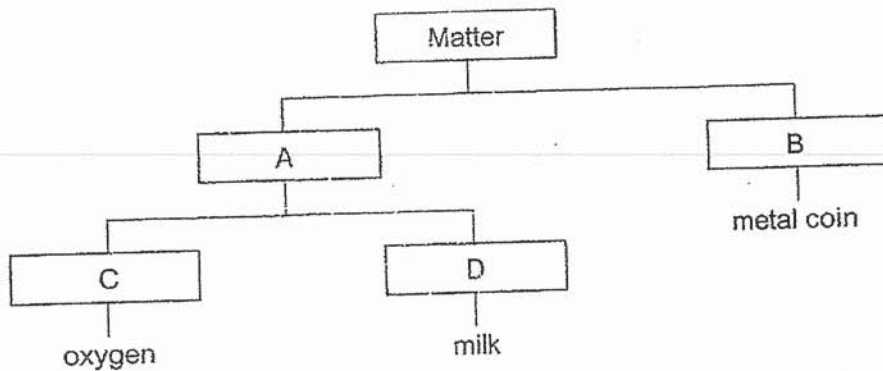

Which one of the following shows correctly the properties of A, B, C and D?

	A	B	C	D
(1)	has no definite shape	has definite shape	has definite volume	has no definite volume
(2)	has definite shape	has no definite shape	has definite volume	has no definite volume
(3)	has no definite volume	has definite volume	has no definite shape	has definite shape
(4)	has no definite shape	has definite shape	has no definite volume	has definite volume

12. Kiera was given the following set-up. She was asked to push the inverted cup into the trough.

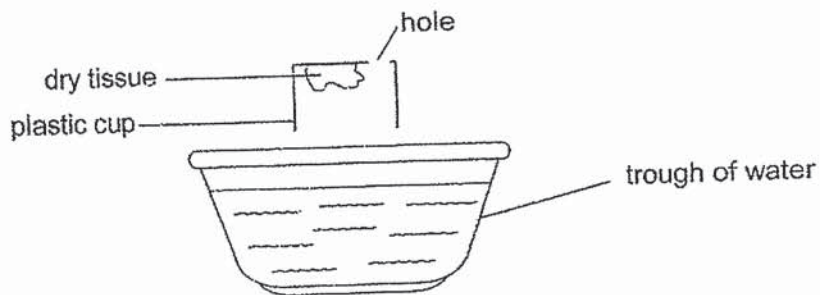

What will most likely happen?

- A The tissue will be wet.
- B The tissue will remain dry.
- C Air will leave the cup through the hole.

- (1) A only
- (2) B only
- (3) A and C
- (4) B and C

13. The diagram shows a sealed metal box containing 140 cm³ of oil and 60 cm³ of air.

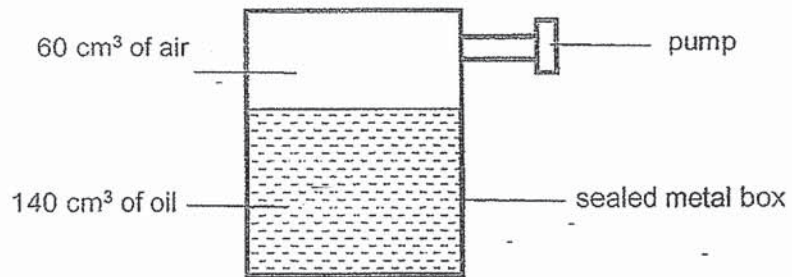

John pumped 20 cm³ of oil and 30 cm³ of air into the metal box.

What is the final volume of oil and air in the metal box?

	Volume of oil (cm ³)	Volume of air (cm ³)
(1)	140	60
(2)	160	40
(3)	160	60
(4)	160	90

14. Which one of the following is **not** a source of heat?

(1)

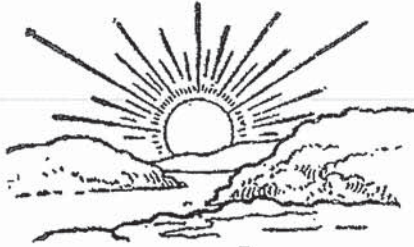

Sun

(2)



lighted candle

(3)

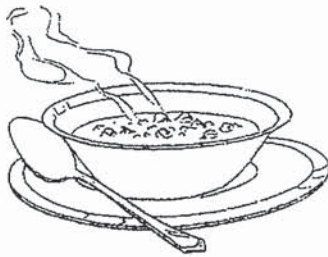

hot soup

(4)



jacket

15. Ellie placed a block of ice on a metal plate at point X as shown in the diagram.

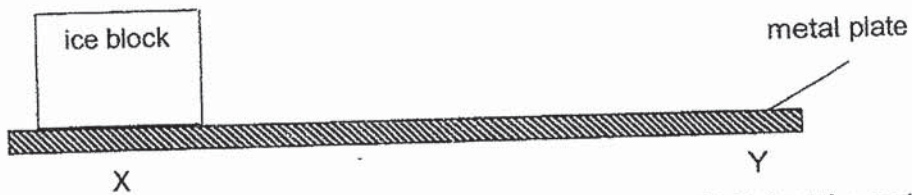

After some time, Ellie observed the block of ice was melting and felt that the metal plate at Y was colder.

Which one of the following explains correctly Ellie's observations?

	ice block	metal plate
(1)	gained heat from the metal plate	lost heat to the ice block
(2)	gained heat from the metal plate	lost heat to the surrounding air
(3)	lost heat to its surroundings	gained heat from the ice block
(4)	lost heat to its surroundings	gained heat from the surrounding air

16. What is the temperature of the cold water?

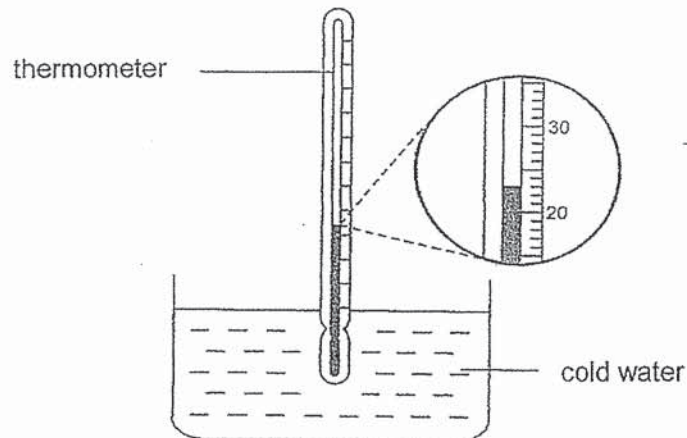

- (1) 23°C
- (2) 25°C
- (3) 27°C
- (4) 37°C

17. Equal amounts of wax are placed at different points (A, B, C and D) of a metal arc. One point of the arc is heated as shown in the diagram.

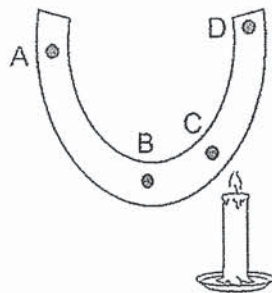

At which one of the following positions will the wax melt last?

- (1) A
- (2) B
- (3) C
- (4) D

18. Gary needs to buy a new pot. He decided to buy a pot with a rubber handle instead of a metal one.

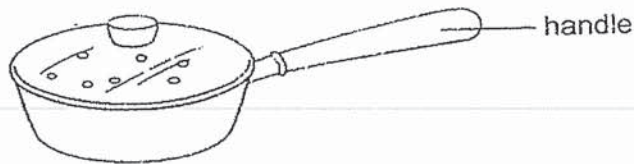

Which one of the following statements best explains his choice?

- (1) Metal is stronger than rubber.
 - (2) Rubber is more flexible than metal.
 - (3) Metal is waterproof while rubber is not.
 - (4) Rubber is a poorer conductor of heat than metal.
19. Jack filled two beakers, A and B, each with 300 ml of water at different temperatures.

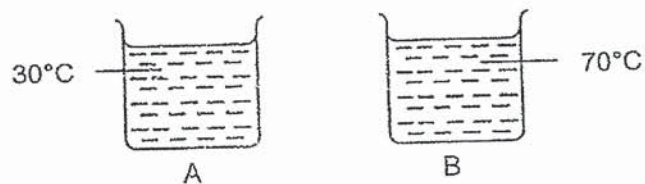

He poured the water from beakers A and B into an empty basin as shown below.

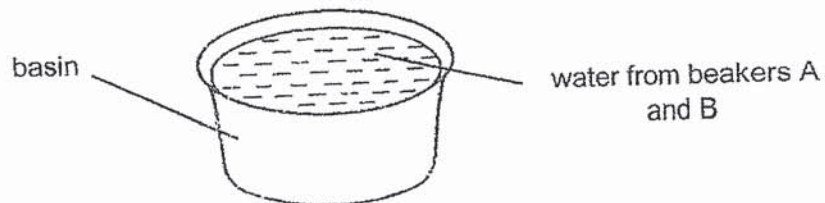

What is the temperature of the water in the basin immediately after the two beakers were emptied into it?

- (1) 100°C
- (2) More than 70°C
- (3) Lower than 30°C
- (4) Between 30°C and 70°C

20. Harry wanted to find out how fast ice can melt in four different types of containers, A, B, C and D.

He put three ice cubes in container A. After thirty minutes, he collected the water in container A.

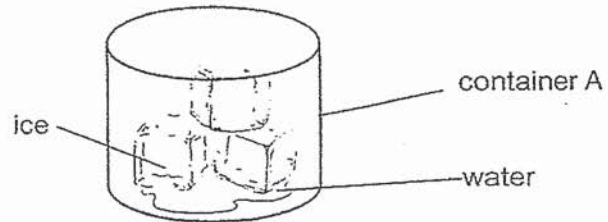

He repeated his experiment using the other three containers and recorded his findings in a bar graph as shown below.

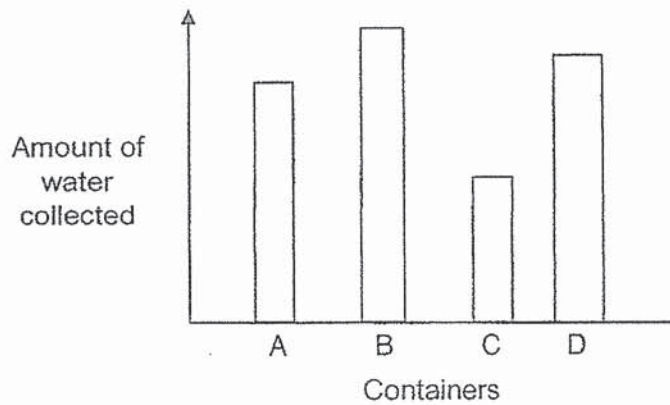

Which one of the following containers should he use to keep his food warm for a long time?

- (1) A
- (2) B
- (3) C
- (4) D

21. The characteristics of four organisms, W, X, Y and Z, are described below.

- W has fur and gives birth to young
- X lays eggs and has dry scales
- Y lays eggs and is able to breathe both on land and under water
- Z is able to live both on land and in water. Has feathers for outer covering

Which one of the following correctly classifies organisms W, X, Y and Z?

	Amphibian	Reptile	Mammal	Bird
(1)	Y	X	W	Z
(2)	X	Y	W	Z
(3)	X	Y	Z	W
(4)	Y	X	Z	W

22. Diagram A shows a puffer fish.

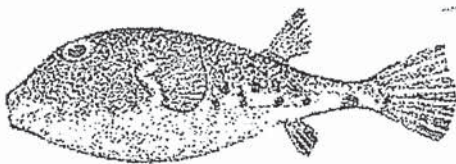

Diagram A

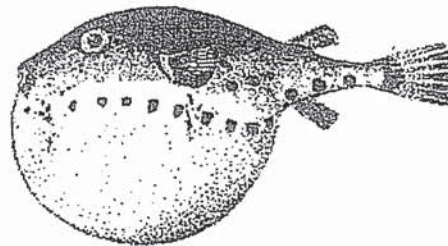

Diagram B

When the puffer fish is attacked, it makes itself look bigger as shown in diagram B.

The observation above shows that a puffer fish can

- (1) grow.
- (2) reproduce.
- (3) respond to changes.
- (4) attack other living things.

23. Which of the following about ferns and fungi are correct?

		Fern	Fungi
A.	Do they make their own food?	Yes	No
B.	Do they need water?	Yes	Yes
C.	Do they reproduce by spores?	No	Yes

- (1) A and B only
- (2) A and C only
- (3) B and C only
- (4) A, B and C

24. The diagram below shows a pair of swimming goggles.

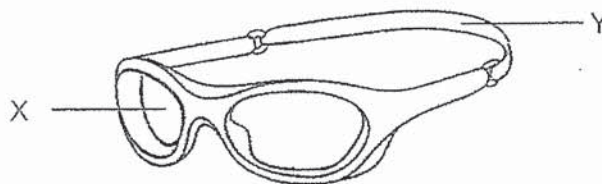

Which materials are most suitable to make parts X and Y?

	X	Y
(1)	plastic	wood
(2)	metal	wood
(3)	metal	rubber
(4)	plastic	rubber

25. The diagrams show the life cycles of a mosquito and a frog.

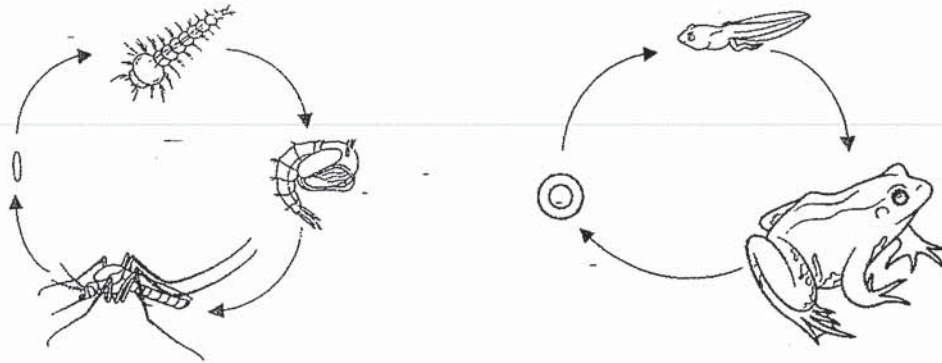

How are the two life cycles similar?

- A Both young do not look like the adult.
- B Both adults live on land and in water.
- C At least two stages of their life cycles are spent in water.
- D They have the same number of stages in their life cycles.

- (1) A only
- (2) A and C
- (3) B and C
- (4) C and D

26. Two different types of objects are placed in trays A, B, C and D.

- Tray A Beans and sugar cubes
- Tray B Plastic buttons and steel needles
- Tray C Wooden sticks and plastic beads
- Tray D Steel needle and iron thumbtacks

In which tray can the 2 objects be separated easily using a magnet?

- (1) A
- (2) B
- (3) C
- (4) D

27. Katrina has 4 bar magnets, A, B, C and D, which are of the same thickness but different lengths.

magnet A

N	S
---	---

magnet B

N	S
---	---

magnet C

N	S
---	---

magnet D

N	S
---	---

She carried out an experiment by putting each magnet into a box of metal paper clips. She lifted the magnets and counted the number of paper clips attracted to each magnet.

The table shows her results.

	Magnet A	Magnet B	Magnet C	Magnet D
Number of paper clips attracted	10	8	16	13

Based on the results given, which one of the following is a suitable conclusion for Katrina's experiment?

- (1) Magnet B is the strongest magnet.
 - (2) The thickness of the magnet affects its magnetism.
 - (3) The longer the magnet, the stronger its magnetism.
 - (4) The strength of a magnet does not depend on its length.
28. Megan observed that the door of a refrigerator is made of metal. She placed a magnet on the door of the refrigerator and it dropped off immediately.
- Which of the following statements is likely to be correct?
- (1) The refrigerator door is made of a steel.
 - (2) The refrigerator door is too cold for the magnet.
 - (3) The magnet lost its magnetism to the refrigerator door.
 - (4) The refrigerator door is made of a non-magnetic material.

End of Section A



HENRY PARK PRIMARY SCHOOL
FIRST SEMESTRAL ASSESSMENT 2019

PRIMARY 4

SCIENCE

BOOKLET B (44 MARKS)

INSTRUCTIONS TO CANDIDATES

1. Do not turn over this page until you are told to do so.
2. Follow all instructions carefully.
3. Answer all questions.

Name: _____ ()

Class: Primary 4 ()

Date: 22 May 2019

Total Time: 1 h 45 min

Marks for Booklet B: _____

Section B (44 marks)

For questions 29 to 40, write your answers in the space provided.

The number of marks available is shown in brackets [] at the end of each question or part question.

29. Siti wanted to find out if cutting food P into smaller pieces affects how quickly the food is digested. She prepared 2 set-ups, X and Y, as shown in the diagram.

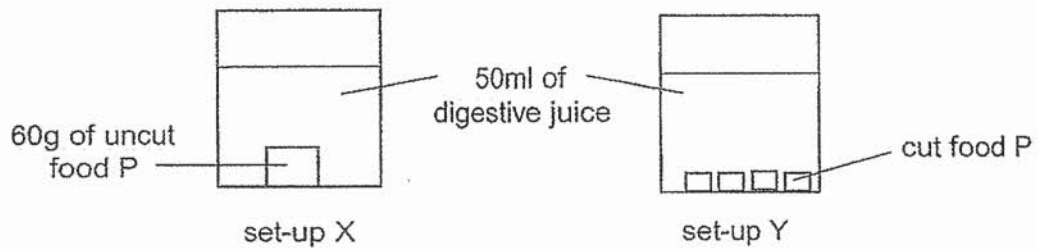

- (a) What should the total mass of the cut food in set-up Y be? [1]

- (b) Explain why food in set-up Y digests faster. [2]

- (c) Which organ in the digestive system cuts food into smaller pieces? [1]



30. The diagrams below show different human body systems.

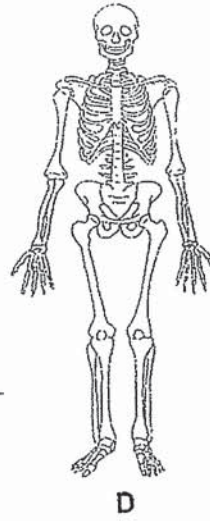
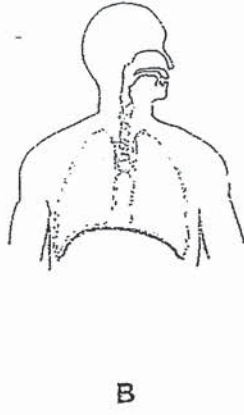
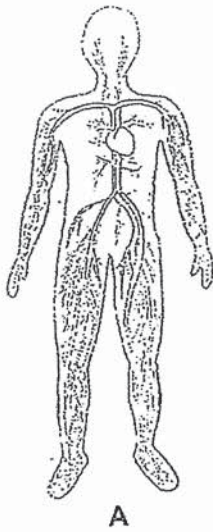

For each function given in the table below, write the correct letter (A, B, C or D). [3]

Function	Human Body System (A, B, C or D)
(a) It protects the vital organs in the body.	
(b) It takes in oxygen from the air.	
(c) It helps the different parts of the body to move.	



31. Miss Chan poured sugar from a packet into an empty container as shown below.

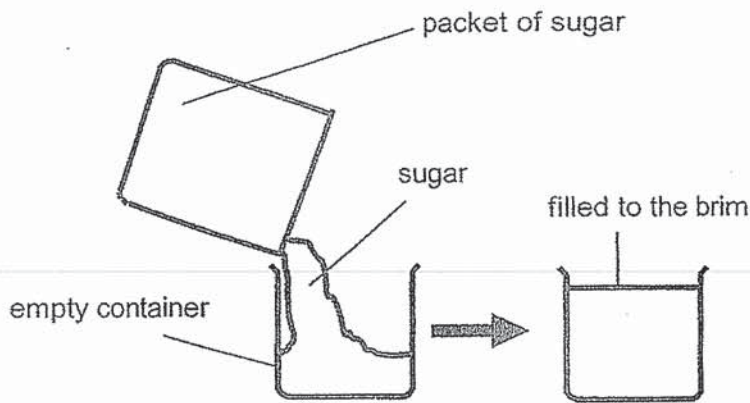

Miss Chan realised that there was some sugar left in the packet but the container was already filled to the brim.

She then knocked the sides of the container a few times and observed that there was more space in the container as shown below.

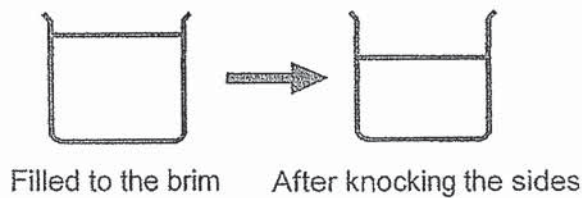

(a) What state of matter is the sugar in? [1]

(b) Why was there more space in the container after Miss Chan knocked the sides of the container? [2]

(c) State one property of matter that Miss Chan observed. [1]

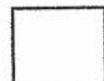

32. Lenny placed two empty containers, A and B, each with a volume of 400 cm^3 , on the balance scales as shown below.
She balanced the containers with weights of equal mass.

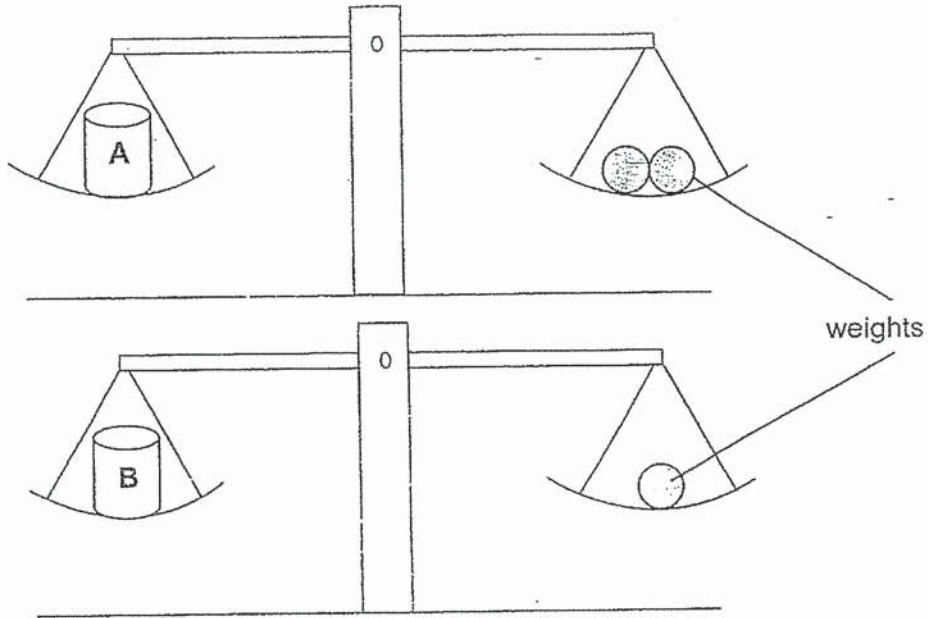

- (a) Which container A or B has a greater mass? [1]

- (b) State one possible reason why the masses of containers A and B can be different. [1]



Question 32 continued

Lenny then pumped 300 cm^3 more air into container B and placed both containers on a balance scale. He observed that the scale was balanced.

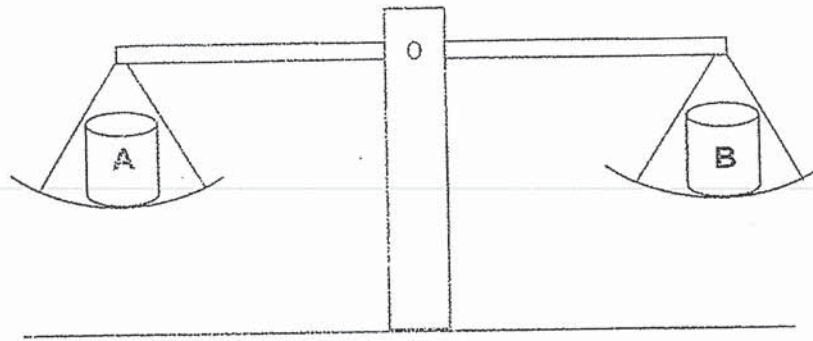

(c) Explain why the scale is balanced now.

[2]



33. Melissa observed three substances, **K**, **L** and **M**. She recorded her observations in the table below.

Substance	Has mass	Takes the shape of its container	Can be seen	Fixed Volume
K	✓	✓		
L	✓		✓	✓
M	✓	✓	✓	✓

(a) From her observation, what state of matter is substance **K** in? [1]

(b) Using the information given in the table, explain your answer in (a). [2]

(c) Based on Melissa's observation, state one similarity between substance **L** and **M**. [1]

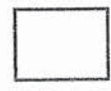

34. The diagram below shows a glass container containing hot lemon tea and some ice cubes in a room of temperature of 30°C.

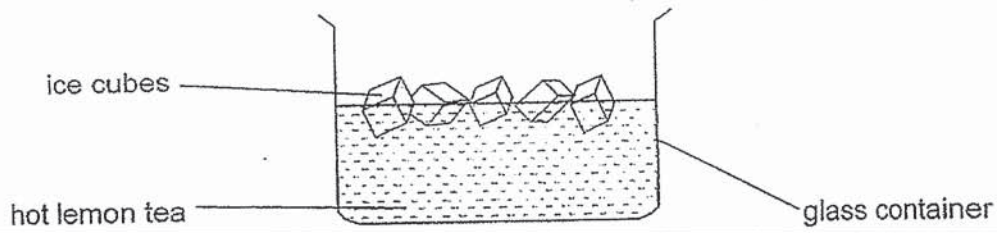

- (a) Put a tick (✓) in the correct box in the table below to indicate whether the objects gained or lost heat. [1]

	hot lemon tea	ice cubes
gained heat		
lost heat		

- (b) What would happen to the ice cubes after two minutes? [1]

- (c) After three hours, what will the temperature of the lemon tea be? Explain your answer. [2]



35. Nathan placed a cup of hot coffee in an air-conditioned room and recorded the temperature of the coffee over 50 minutes. He recorded his observations in the table below.

Time (min)	Temperature ($^{\circ}\text{C}$)
0	85
5	80
10	65
15	50
20	42
25	30
30	25
35	20
40	16
45	16
50	16

- (a) What happened to the temperature of the coffee? [1]

- (b) Explain your answer in (a). [1]

- (c) Nathan switched off the air conditioner in the room and opened the windows in the room. [2]

Given that the temperature outside the room is 32°C , will the temperature of the coffee remain at 16°C ?

Explain your answer.



36. Peter carried out an experiment as shown below. He wanted to find out whether the amount of water will affect how well an egg is cooked. He used two identical beakers of water containing different amount of water which are heated to 80°C.

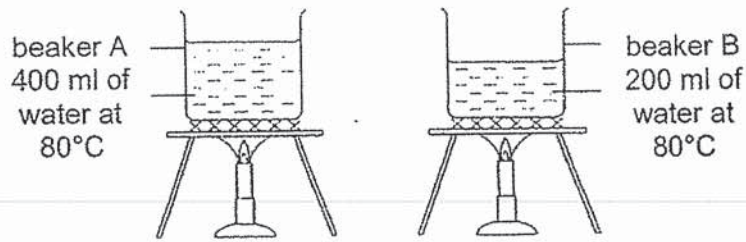

He also placed eggs of identical mass into each of the beaker as shown below.

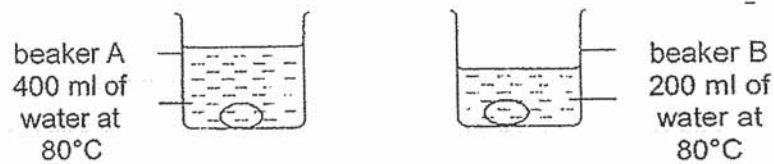

After 5 minutes, each of the eggs was taken out of the beakers and cracked into a bowl to observe the amount of uncooked portion as shown in the table below.

The observations were recorded in the table below.

Egg in beaker A	Egg in beaker B
No uncooked portion	Some uncooked portion

- (a) Explain why the results for eggs in beakers A and B are different. [2]

- (b) Besides leaving the egg in the hot water for a longer time, suggest another way Peter can ensure the egg in beaker B is fully cooked. [1]

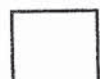

Question 36 continued

Peter then placed two other eggs of equal mass in beakers C and D as shown in the diagrams below.

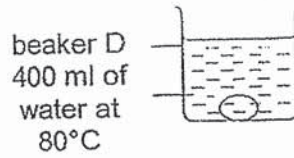
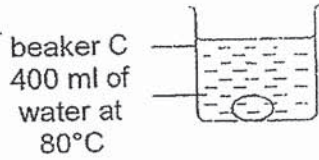

Both beakers contained equal amount of water with a temperature of 80°C. Beaker C was made of metal while beaker D was made of plastic.

After 5 minutes, he took out the eggs. He found out that the egg in beaker D was fully cooked while the egg in beaker C was partially cooked.

- (c) Explain why the egg in beaker C was only partially cooked. [1]



37. Xavier observed that organism Z breathes in water using its gills.

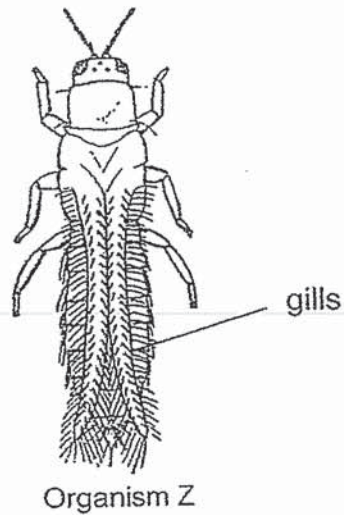

(a) Xavier concluded that organism Z is a fish. [2]

Do you think his conclusion is correct? Explain your answer.

(b) Which group of living things does organism Z belong to? [1]



38. The diagram below shows an umbrella.



- (a) The umbrella can be used in sunny or rainy weather conditions. Complete the table below by stating which property of material F is useful in different weather conditions. [2]

Weather	Property of material
Sunny	
Rainy	

- (b) Explain why material G is usually metal. [2]



39. Bala carries out an experiment using the following set up.

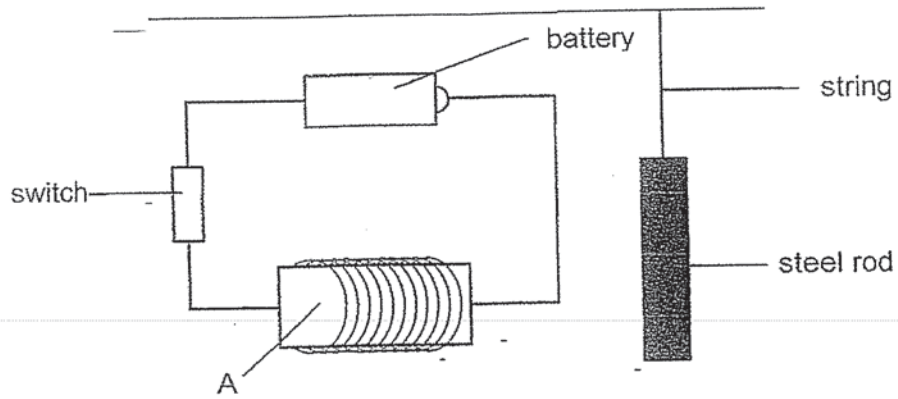

(a) Explain why the rod moves towards A when the switch is turned on. [2]

Bala modified his set up as shown below.

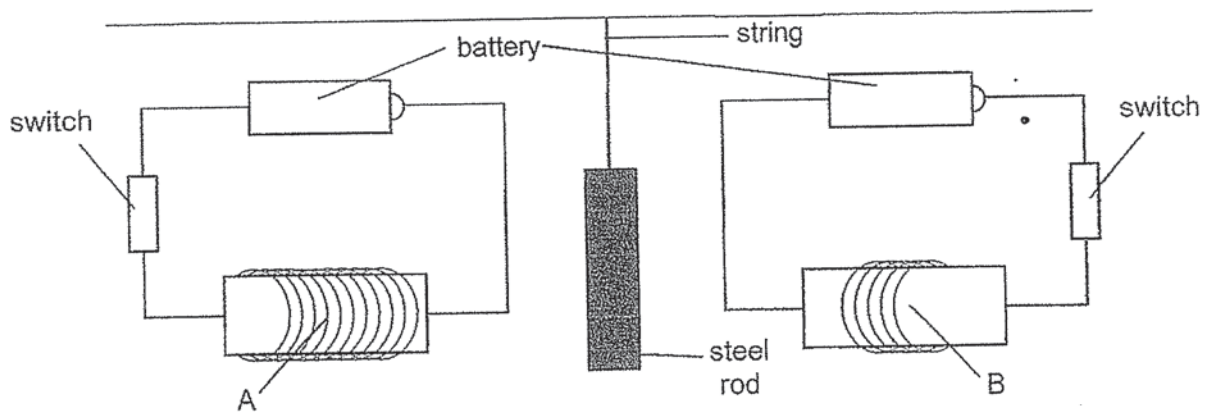

(b) Bala turned on both switches and observed that the rod moved towards A instead of B. [2]

Explain his observation.



40. The diagram below shows the life cycle of a butterfly.

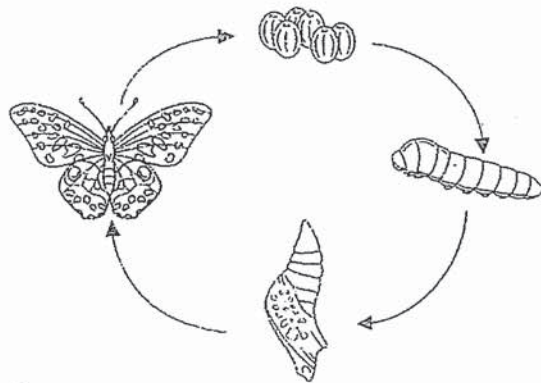

(a) At which stage(s) is the butterfly able to reproduce? [1]

(b) At which stage(s) did the butterfly not eat at all? [1]

End of Section B

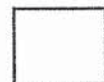

CORRECTIONS SHEET FOR P4 SCIENCE 2019 SA1

Q1	1	Q8	3	Q15	1	Q22	3
Q2	4	Q9	2	Q16	1	Q23	1
Q3	4	Q10	1	Q17	1	Q24	4
Q4	1	Q11	4	Q18	4	Q25	2
Q5	4	Q12	3	Q19	4	Q26	2
Q6	1	Q13	2	Q20	3	Q27	4
Q7	4	Q14	4	Q21	1	Q28	4
29a	60g						
b	Food in set-up Y is cut into smaller pieces so there are more parts of the food which is in contact with the digestive juice.						
c	Mouth or teeth						
30	D B C						
31 a	Solid						
31 b	Air trapped in between the sugar escaped when Ms Chan knocked the sides of the container. The rest of the sugar then to took the space left by the air.						
31 c	Matter occupies space						
32a	Container A						
32b	They are made of different materials						
32c	Air that was pumped in has mass, so container B becomes heavier.						
33a.	Gas						

33b.	It does not have a definite shape and does not have a fixed volume.	
33c.	Can be seen / have a fixed volume / have mass	
34a.	Hot Lemon Tea – Lost heat Ice Cubes – Gained heat	
34b.	The ice cubes will melt	
34c.	It will be at room temperature. The lemon tea will continue losing heat to the surrounding air until it has the same temperature as the surrounding air.	
35a.	The temperature decreased	
35b.	The heat from the hot coffee travels to the surrounding air.	
35c.	No, the temperature of coffee will increase. The surrounding air gains heat from outside the room and gets warmer so, the coffee will gain heat from the warm surrounding air.	
36a	In beaker A, there is more heat as there is more amount of water, so the egg from beaker A has no uncooked portion.	
36b	more hot water white plastic is a poor conductor of heat	
36c	Metal is a better conductor of heat so heat from hot water is conducted to the surrounding air faster.	
37a.	No. Z has 6 legs but a fish does not.	
37b.	Insect/Animal	

38a.	Sunny –Does not allow light to pass through through Rainy – Waterproof	
38b.	Metal is strong	
39a.	A becomes an electromagnet and is able to attract the steel rod as it is a magnetic material.	
39b.	Electromagnet A is stronger as it has more coils around it.	
40a.	Adult	
40b.	Egg and Pupa	

END

