



NAN HUA PRIMARY SCHOOL
CONTINUAL ASSESSMENT 2 – 2010
PRIMARY 5

MATHEMATICS

Paper 1

Section A: 15 Multiple Choice Questions (20 marks)

Section B: 10 Short Answer Questions (20 marks)

Total Time for Paper 1: 50 minutes

INSTRUCTION TO CANDIDATES

1. Write your name and index number in the space provided.
2. Do not turn over the page until you are told to do so.
3. Follow all instructions carefully.
4. Answer all questions.
5. Shade your answers in the Optical Answer Sheet (OAS) provided for Questions 1-15.
6. You are not allowed to use calculator for Paper 1.

Marks Obtained

Paper 1		/ 40
Paper 2		/ 60
Total		/ 100

Name : _____ ()

Class : _____

Date : 24 August 2010

Parent's Signature: _____

Section A (20 marks)

Questions 1 to 10 carry 1 mark each.

Questions 11 to 15 carry 2 marks each.

For each question, four options are given. One of them is the correct answer.

Make your choice (1, 2, 3 or 4) and shade on the oval (1, 2, 3 or 4) on the Optical Answer Sheet.

1. The number of people in a stadium was 30 000 after being rounded off to the nearest thousand. Which one of the following can be the actual number of people in the stadium?

- (1) 29 099
- (2) 29 598
- (3) 30 657
- (4) 30 909

2. Which of the following fractions is greater than $\frac{1}{3}$?

- (1) $\frac{10}{33}$
- (2) $\frac{8}{27}$
- (3) $\frac{7}{18}$
- (4) $\frac{4}{15}$

3. Arrange the following numbers in descending order.

4.5 , 4 , 4.005 , 4.05

- (1) 4.005 , 4.05 , 4.5 , 4
- (2) 4.5 , 4.05 , 4.005 , 4
- (3) 4 , 4.005 , 4.05 , 4.5
- (4) 4 , 4.5 , 4.05 , 4.005

4. $28.12 \times 2 = 2812 \times \underline{\hspace{2cm}}$

(1) 200

(2) $\frac{100}{2}$

(3) $\frac{2}{100}$

(4) $\frac{1}{200}$

5. The ratio of the number of apples to the number of mangoes in a basket is 5 : 2. There are 4 times as many pears as mangoes in the basket. What is the ratio of the number of apples to the total number of fruits in the basket?

(1) 1 : 3

(2) 1 : 2

(3) 5 : 7

(4) 5 : 12

6. Express $\frac{6}{20}$ as a percentage.

(1) 6%

(2) 24%

(3) 26%

(4) 30%

7. Mr Tan has a long plank of wood. He took 4 minutes to saw it into 3 pieces. How long does it take for him to saw it into 12 pieces?

(1) 12 min

(2) 16 min

(3) 22 min

(4) 48 min

8. The graph below shows the number of children per family in a HDB block.

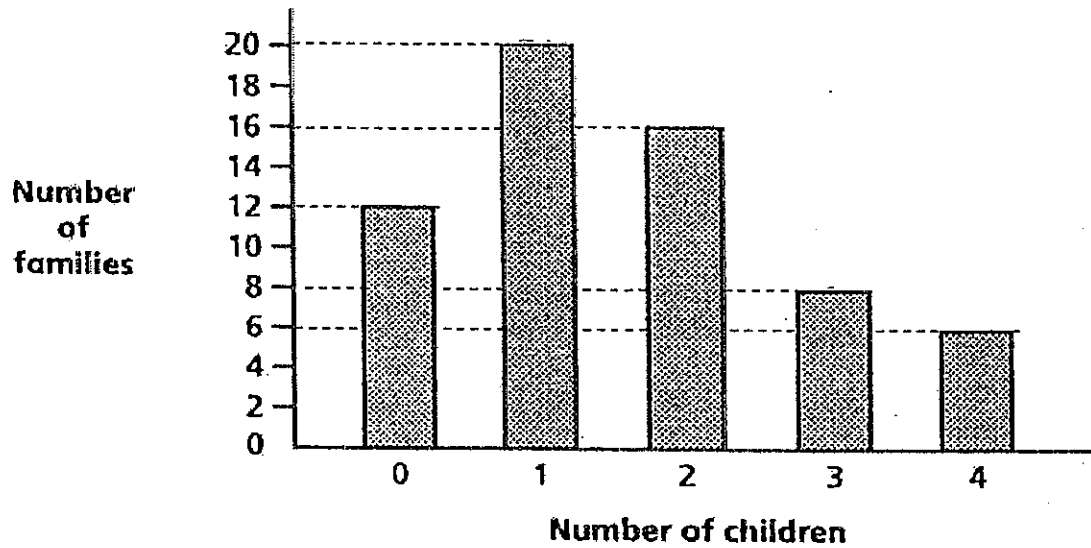

How many families have at least 2 children?

- (1) 14
- (2) 16
- (3) 30
- (4) 50

9. Find the shaded area of the triangle below.

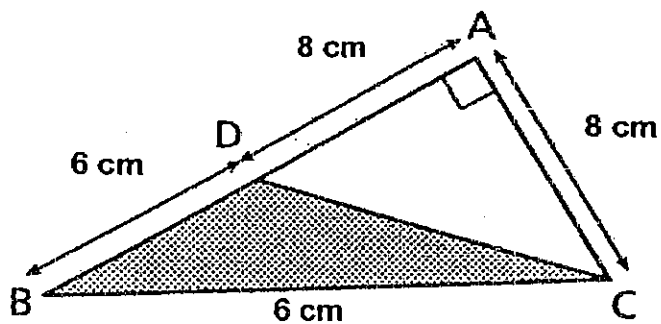

- (1) 18 cm^2
- (2) 24 cm^2
- (3) 32 cm^2
- (4) 56 cm^2

10. Mrs Tan wants to lay her kitchen with tiles of a shape that can be tessellated. Which of these shapes cannot be tessellated?

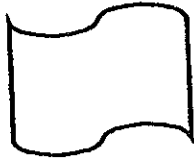

(1)

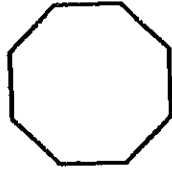

(2)

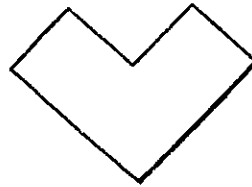

(3)

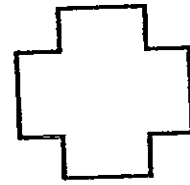

(4)

11. Find the difference between 92.21 and 33.25 and round off to the nearest tenth.

- (1) 58.0
- (2) 59.0
- (3) 58.96
- (4) 59.90

12. Lucy saved 40% of her bonus and spent the rest. She paid \$360 for a new camera and \$120 for a dress. How much did Lucy save?

- (1) \$320
- (2) \$480
- (3) \$720
- (4) \$800

13. William uses stickers of four different shapes to make a pattern. The first 12 stickers are shown below. What is the shape of the 71st sticker?

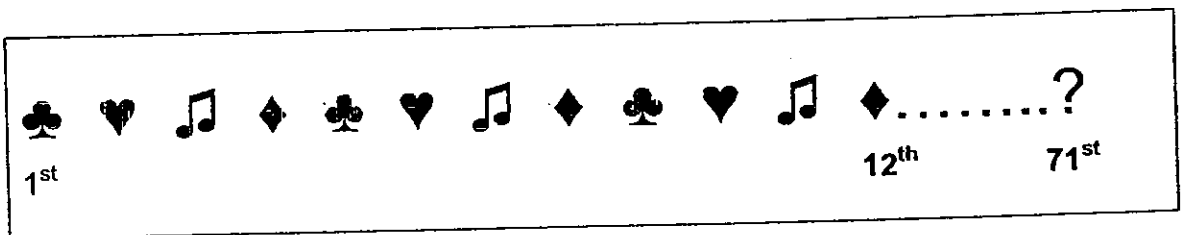

- (1)
- (2)
- (3)
- (4)

14. The figure below consists of a rectangle and a square. Find the difference between $\angle x$ and $\angle y$.

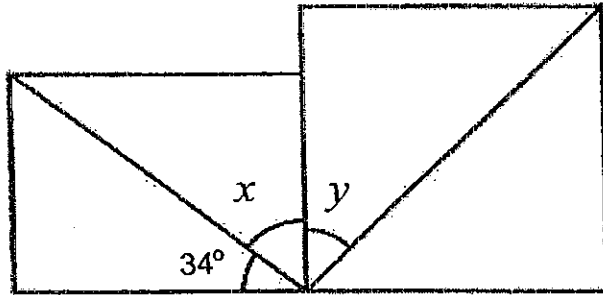

- (1) 11°
 (2) 56°
 (3) 101°
 (4) 112°

15. The table below shows the number of Chinese, Malay, Indian and Eurasian pupils in a kindergarten.

Races	Chinese	Malay	Indian	Eurasian
Number of pupils	76	?	32	?

The average number of pupils for the four races is 45.
 There are equal number of Malay and Eurasian pupils.
 How many Eurasian pupils are there?

- (1) 36
 (2) 72
 (3) 108
 (4) 180

Section B (20 marks)

Questions 16 to 25 carry 1 mark each. Questions 26 to 30 carry 2 marks each.
For each question from 26 to 30, show your workings clearly in the space below it and write your answer in the space provided. Give your answers in the units stated.

16. $\frac{A}{49} = \frac{5}{\frac{B}{35}} = \frac{1}{7}$

$\frac{A}{B} = \boxed{}$

What is the missing fraction in the box?

Ans: _____

17. $\frac{8}{9}$ of a pizza was shared equally among 12 children.

What is the fraction of pizza eaten by each child?

Ans: _____

18. Express 9.06 litres in *ml*.

Ans: _____ *ml*

19. The ratio of Christine's age to Wendy's age is 5 : 6.
In 5 years' time, their total age will be 76.
What is Wendy's age now?

Ans: _____ years old

20. The sum of 8 hundredths and 2.95 is _____.

Ans: _____

21. Lenny paid \$110 for a tennis racket.
One month later, he sold it to Gabriel at a loss of 30%.
How much did Gabriel pay for the tennis racket?

Ans: \$ _____

22. Find the average of the following numbers.

16	,	22	,	0	,	39	,	43
----	---	----	---	---	---	----	---	----

Ans: _____

23. The area of one side of the cube shown below is 25 cm^2 .
What is the volume of the cube?

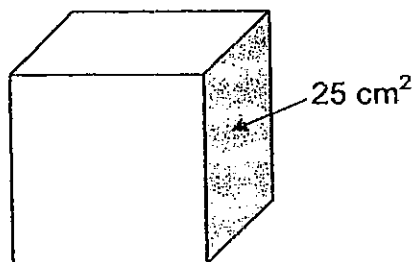

Ans: _____ cm^3

24. Half a dozen of chicken satay are sold for \$4.80.
How much does Ahmad have to pay for 30 sticks of satay?

Ans: \$ _____

25. One of the shapes does not fit into the tessellation shown below. Shade it.

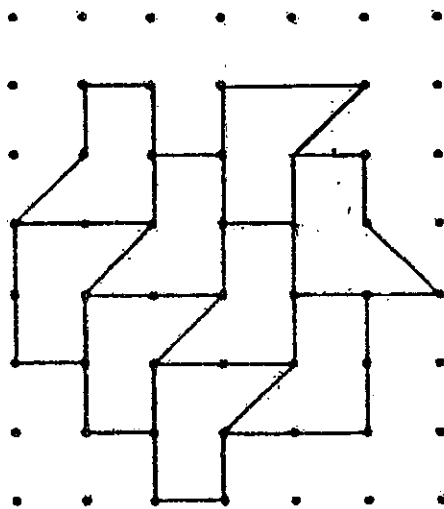

26. 10 street lamps were erected in a row at equal distances. The distance between the first and the fourth street lamp was 24 m. What is the distance between the first and the tenth street lamp?

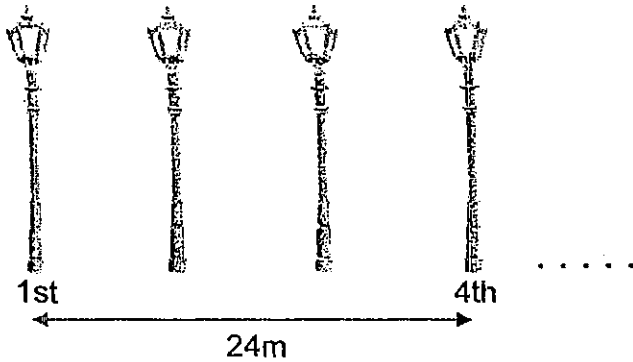

Ans : _____ m

27. In a factory, 20% of the workers are single and the rest are married. There are 33 more married workers than single workers. How many workers are married?

Ans: _____

28. A carpenter has a rectangular block of wood 32 cm by 13 cm by 11 cm. What is the maximum number of 4-cm cubes he can cut from it ?

Ans: _____ 4-cm cubes

29. The figure below shows 14 squares. Add the **least number** of squares required to the figure so that line AB becomes a line of symmetry.

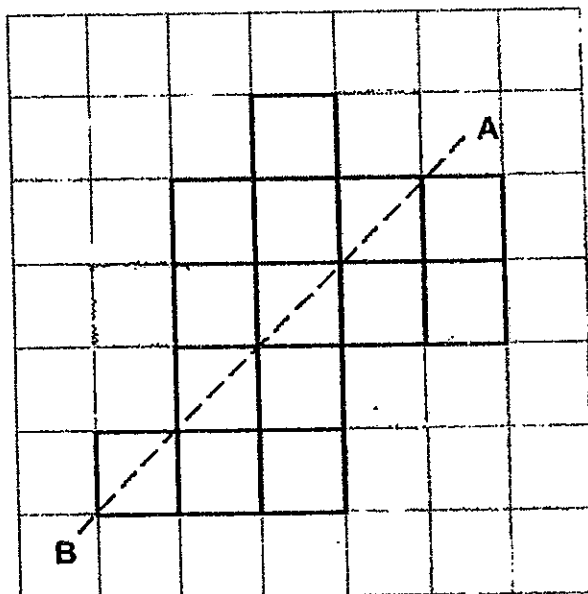

30. A swimming pool was completely drained of water for cleaning.
 At 11 a.m., the tap was turned on to fill the swimming pool with water.
 At 12.30 p.m., the swimming pool was $\frac{3}{7}$ filled with water.
 At what time would the swimming pool be completely filled with water at this rate?

Ans: _____ p.m.

End-of-Paper 1

Paper 2 (60 marks)

Questions 1 to 5 carry 2 marks each. Show your workings clearly in the space below it and write your answer in the space provided. Give your answers in the units stated.

1. 40% of the bean bags in the PE storeroom are green.
50% of the remaining bean bags are red and blue.
The rest of the bean bags are yellow.
~~Find the percentage of the yellow bean bags.~~

What percentage of the bean bags are yellow?

Ans: _____%

2. A rectangular park has length of 250 m and breadth of 180 m.
The park is covered with grass in triangular formations as shown in the shaded area below.
Find the area of the park that is **not** covered by grass.

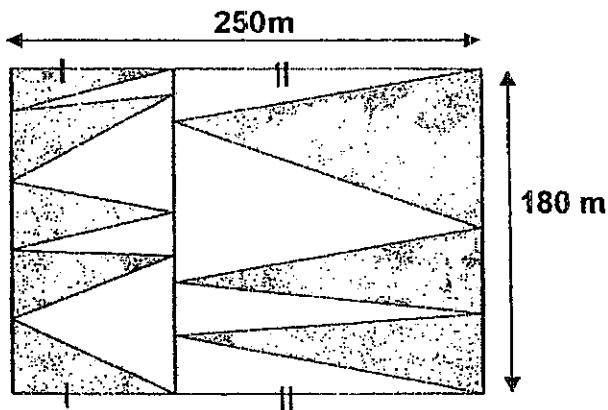

Ans: _____m²

3. In order to get a reward from his father, Joe must score an average of 91 marks or more for his 3 tests. Joe scores 89 and 88 for the first 2 tests. What is the minimum mark that he needs to score in the third test in order get the reward?

Ans: _____ marks

4.

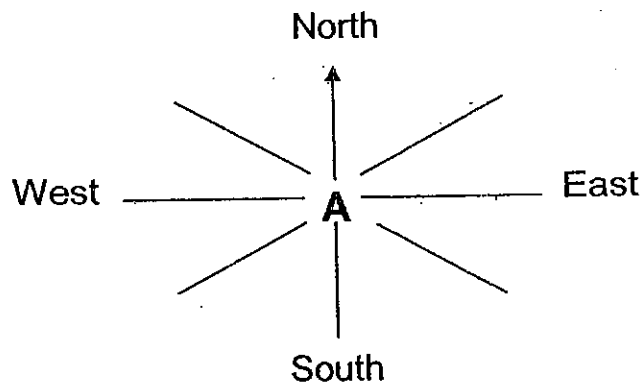

Lilian is standing at Point A. She is facing north. She turns in the anti-clockwise direction until she faces east. She turns through an angle of _____.

Ans: _____^o

5. At a drink stall, there are 5 pupils queueing in front of David. There are 7 children queueing between David and Zoe. Zoe is the fourth from the last pupil in the queue. How many pupils are there in the queue?

Ans: _____ pupils

For each question from 6 to 18, show your workings clearly in the space below it and write your answer in the space provided. The number of marks available is shown in brackets [] at the end of each question or part-question. Remember to include the units wherever possible.

6. The graph below shows the number of visitors to the crocodile farm over a 6-month period.

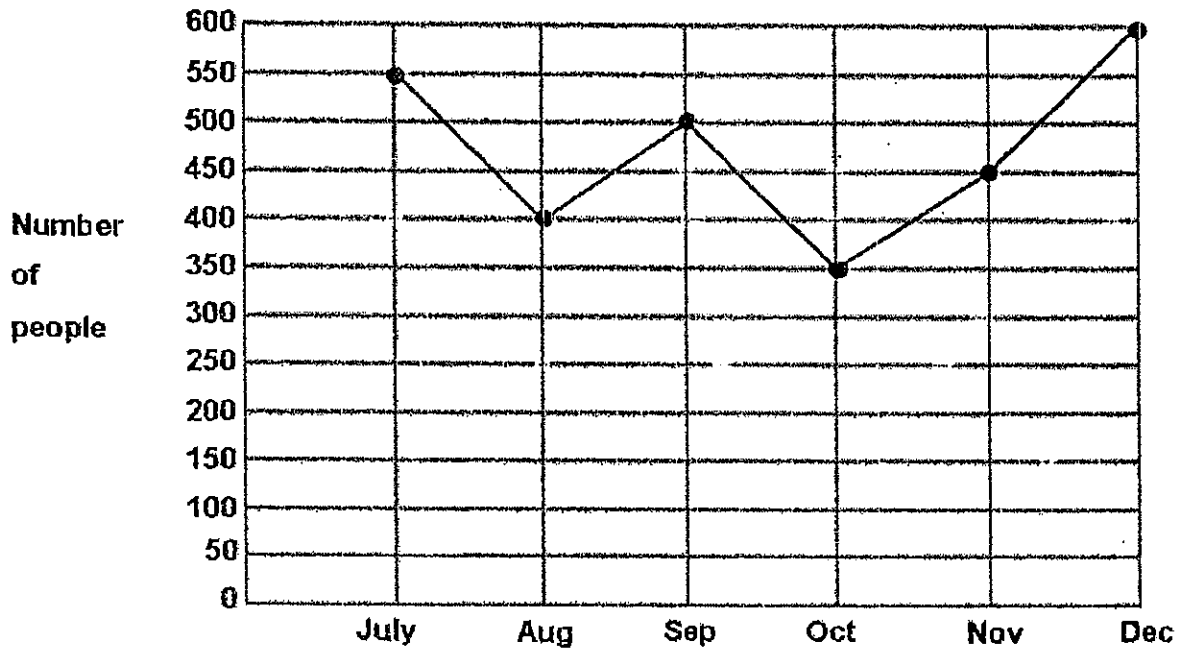

- (a) What is the average number of visitors to the Crocodile Farm from July to December?

Ans: _____ [1]

- (b) How many percent fewer visitors was there in October than in September?

Ans: _____ [2]

7. 75% of Lenny's savings is the same as 50% of Andrew's savings.
If Andrew's savings is \$240 more than Lenny's savings, what is the total savings of the two boys?

Ans: _____ [3]

8. The teacher-to-pupil ratio for an excursion was 3 : 16.
The number of girls was $\frac{7}{9}$ of the number of boys.
There are 72 boys who had gone on the excursion.
How many teachers were there?

Ans: _____ [3]

9. Helen and Jane went shopping with a total amount of \$184.
After Helen spent $\frac{1}{3}$ of her money and Jane spent $\frac{4}{7}$ of hers, they had the same amount of the money left.
How much money did Jane have at first?

Ans: _____ [3]

10. The total mass of Clive, Bala and Julie is 175.5 kg.
Clive is 26.4 kg heavier than Bala and 14.1 kg heavier than Julie.
Find the total mass of Clive and Julie.

Ans: _____ [3]

11. 60% of the pupils in a class are boys.
 $\frac{3}{4}$ of the girls and $\frac{2}{3}$ of the boys scored distinction for a test.
What percentage of the pupils in the class did not score distinction for the test?

Ans: _____ [3]

12. Sean, Nick and Owen shared 420 stickers. Sean gets 48 more stickers than Nick. Owen gets $\frac{1}{4}$ as many stickers as Sean.
How many **more** stickers does Nick have than Owen?

Ans: _____ [4]

13. Janet has \$82.80 worth of coins in denomination of \$1, 50 cents and 20 cents.

The number of \$1 coins is $\frac{4}{5}$ of the number of 50-cent coins she has.

The number of 20-cent coins is half the total number of \$1 coins.

How many of 50-cent coins does she have?

Ans: _____ [4]

14. Mr Tan needed to buy some equipment for his company. He saw the following advertisement.

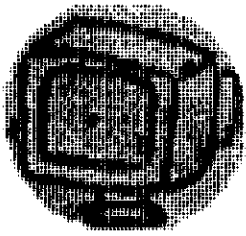
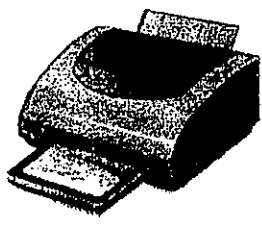
<p>Computer</p>  <p>\$1 400</p>	<p>10% DISCOUNT</p>	<p>Printer</p>  <p>\$360</p>
<p>(Prices listed are before GST)</p>		

He bought 20 computers and 10 printers for his company.

- (a) After the discount, how much did he have to pay before GST?
(b) If he had to pay 7% GST, what was the total amount he had to pay?

Ans: (a) _____ [2]

Ans: (b) _____ [2]

15. At a concert, there were 65 more men than women. After 27 women left the concert midway, the number of men was thrice the number of remaining women.
- (a) How many men were there at the concert?
 - (b) What was the total number of people at the beginning of the concert?

Ans: (a) _____ [3]

Ans: (b) _____ [2]

16. Louis was paid \$1.80 for every set of Christmas cards he sold. In addition, he was given a bonus of \$6.40 for every 12 sets sold. In the month of December, he received a total of \$763.20 from the sale of the Christmas cards. How many sets of Christmas cards did he sell in that month?

Ans: _____ [5]

17. The figure is made up of a square and a rectangle.
 The ratio of the shaded area to the unshaded area of the square is 5 : 11.
 The ratio of the shaded area to the unshaded area of the rectangle is 3 : 4.

(a) What is the shaded area of the square?

(b) What is the breadth of the rectangle?

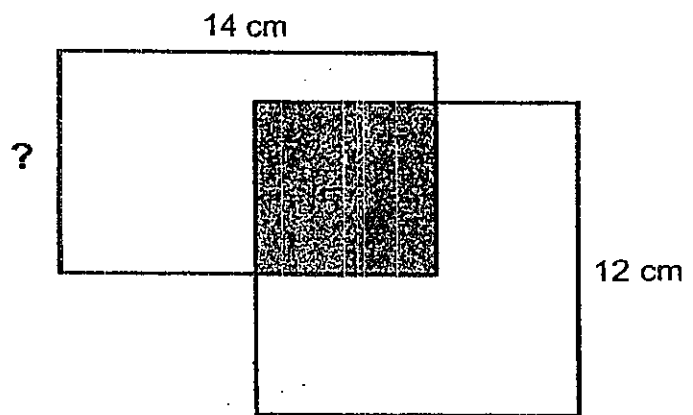

Ans: (a) _____ [2]

Ans: (b) _____ [3]

18. There are 2 700 books in a school library. The number of Chinese, Malay and English books is in the ratio of 5 : 3 : 7 respectively. When 504 new books are added, the number of Chinese books increased by 12% and the number of English books increased by 25 %.

- (a) What is the total number of new Chinese and English books?
- (b) What is the percentage increase in the number of Malay books?

Ans: (a) _____ [3]

Ans: (b) _____ [2]

End-of-Paper

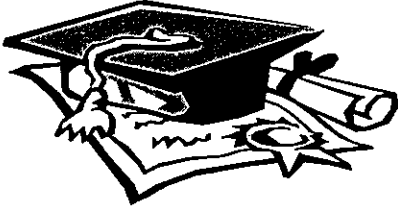

ANSWER SHEET

EXAM PAPER 2010

SCHOOL : NAN HUA PRIMARY
 SUBJECT : PRIMARY 5 MATHEMATICS

TERM : CA2

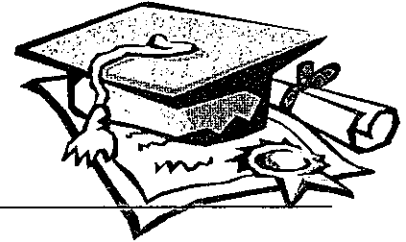

Q1	Q2	Q3	Q4	Q5	Q6	Q7	Q8	Q9	Q10	Q11	Q12	Q13	Q14	Q15
2	3	2	3	1	4	3	3	2	2	2	1	3	1	1

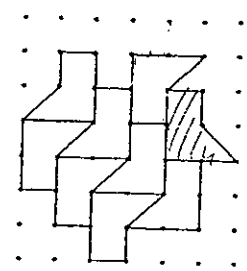
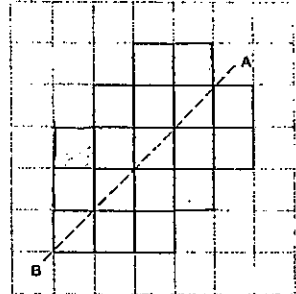
- 16) $1/5$ 17) $2/27$ 18) 9060ml 19) 36 years old 20) 303
- 21) \$77 22) 24 23) 125cm^3 24) \$24 25) 
- 26) 72m 27) 44 28) 48 29) 
- 30) 2.30p.m.

Paper 2

1) Green $\rightarrow 40\%$ Red and Blue $\rightarrow (100\% - 40\%) \div 2$ $= 60\% \div 2 = 30\%$ Yellow $\rightarrow 100\% - (40\% + 30\%)$ $= 100\% - 70\% = 30\%$	2) $\frac{1}{2} \times 250 \times 180 = 22500\text{m}^2$
3) $91 \times 3 = 273$ $88 + 89 = 177$ $273 - 177 = 96$ marks	4) $90 \times 3 = 270^\circ$
5) 17 pupils	6) a) $550 + 400 + 500 + 350 + 450 + 600$ $= 2850$ $2850 \div 6 = 475$ visitors. b) $500 - 350 = 150$ $150/500 = 30\%$

17)a) $12 \times 12 = 144$

$15 + 33 = 48$

$144 \div 48 = 3$

$3 \times 15 = 45\text{cm}^2$

b) $20 + 15 = 35$

$35 \times 3 = 105$

$105 \div 14 = 7.5\text{cm}$

18)a) $5 + 3 + 7 = 15$

$2700 \div 15 = 180$

$180 \times 5 = 900$

$180 \times 7 = 1260$

$12\% \times 900 = 108$

$25\% \times 1260 = 315$

$108 + 315 = 423$

b) $504 - 423 = 81$

$180 \times 3 = 540$

$81/540 \times 100/1 = 15\%$

