



**NAN HUA PRIMARY SCHOOL
SEMESTRAL ASSESSMENT 1 – 2014
PRIMARY 5**

MATHEMATICS

Paper 1

Section A: 15 Multiple Choice Questions (20 marks)

Section B: 15 Short Answer Questions (20 marks)

Total time for Paper 1: 50 minutes

INSTRUCTION TO CANDIDATES

1. Write your name and index number in the space provided.
2. Do not turn over the page until you are told to do so.
3. Follow all instructions carefully.
4. Answer all questions.
5. Shade your answers in the Optical Answer Sheet (OAS) provided for Questions 1-15.
6. You are not allowed to use calculator for Paper 1.

Marks Obtained

Paper 1	Booklet A		/ 40
	Booklet B		
Paper 2			/ 60
Total			/ 100

Name : _____ ()

Class : 5 _____

Date : 16 May 2014

Parent's Signature: _____

Section A (20 marks)

Questions 1 to 10 carry 1 mark each. Questions 11 to 15 carry 2 marks each.
For each question, four options are given. One of them is the correct answer.
Make your choice (1, 2, 3 or 4) and shade on the oval (1, 2, 3 or 4) on the Optical Answer Sheet (OAS).

1. How many thousands are there in 2 780 000?
 - (1) 278
 - (2) 2 780
 - (3) 27 800
 - (4) 278 000

2. Which one of the following has the digit '6' in the hundred thousands place?
 - (1) 1 234 659
 - (2) 2 176 934
 - (3) 3 867 524
 - (4) 4 678 912

3. Find the value of $40 \times 5 + 24 - 8 \div 2$.
 - (1) 108
 - (2) 208
 - (3) 220
 - (4) 520

4. Find the product of $\frac{2}{9}$ and $\frac{3}{10}$.

(1) $\frac{1}{15}$

(2) $\frac{5}{19}$

(3) $\frac{6}{19}$

(4) $\frac{5}{90}$

5. How many quarters are there in $9\frac{1}{2}$?

(1) 18

(2) 19

(3) 36

(4) 38

6. Which one of the following shapes cannot be tessellated?

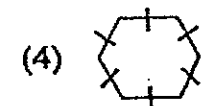
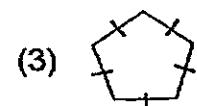
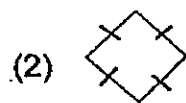
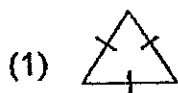



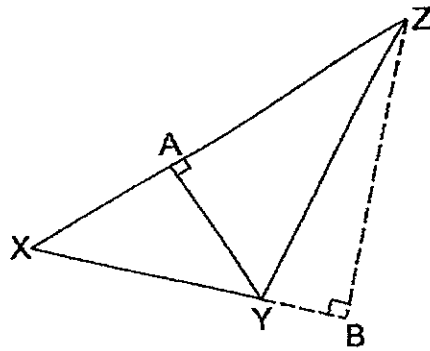

7. In the figure below, not drawn to scale, XYZ is a triangle.
 Given that XY is the base, which one of the following is the height?

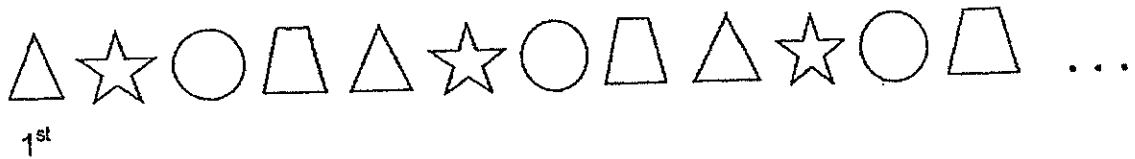

- (1) XA
 (2) AZ
 (3) YZ
 (4) BZ
8. Some shapes are arranged in the following pattern:



Which shape is at the 59th position?

- (1) 
 (2) 
 (3) 
 (4) 

9. The total age of Andy, Bryan and Calvin is 72 years old. Andy is 21 years old. The ratio of Bryan's age to Calvin's age is 1 : 2. How old is Bryan?

- (1) 17 years old
- (2) 24 years old
- (3) 34 years old
- (4) 51 years old

10. Mrs Tan has a total of 150 sweets. 14 of them are apple-flavoured, 36 are grape-flavoured and the rest are orange-flavoured. What is the ratio of the number of orange-flavoured sweets to the number of grape-flavoured sweets?

- (1) 50 : 7
- (2) 25 : 9
- (3) 2 : 3
- (4) 1 : 2

11. Ali has twice as many stickers as Bala and five times as many stickers as Lynn. What is the ratio of the number of stickers Bala has to the number of stickers Lynn has?

- (1) 1 : 1
- (2) 1 : 3
- (3) 2 : 1
- (4) 5 : 2

12. Tony spent $\frac{1}{2}$ of his money on a watch and $\frac{1}{5}$ of his money on a shirt. He then found out that he had \$27 left. How much money did he spend in all?

- (1) \$90
- (2) \$63
- (3) \$45
- (4) \$18

13. A container can either hold 16 identical pencils or 12 identical markers. If there are already 4 such pencils in the container, what is the greatest number of markers that can be placed in the **remaining space** in the container?

- (1) 6
- (2) 9
- (3) 10
- (4) 12

14. Study the following pattern carefully.

$$1 + 2 + 3 + \dots + 93 + 94 + 95$$

When all the numbers from 1 to 95 are added up, what is the digit in the ones' place?

- (1) 1
- (2) 2
- (3) 6
- (4) 0

15. In the figure below, not drawn to scale, ABCD is a rectangle.
 $OA = OD$. $XO = XD$. If triangle XDC is 32 cm^2 , find the area of triangle XAB.

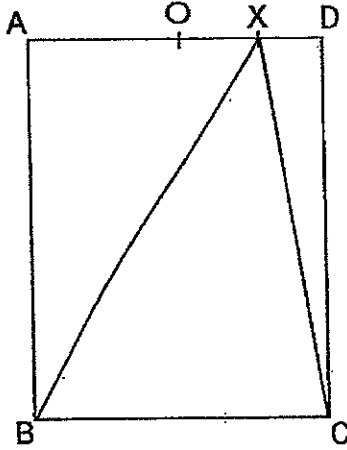

- (1) 64 cm^2
- (2) 96 cm^2
- (3) 128 cm^2
- (4) 160 cm^2

Section B (20 marks)

Questions 16 to 25 carry 1 mark each. Write your answers in the spaces provided. For questions which require units, give your answers in the units stated.

16. $1\frac{3}{8}$ kg = g

Ans: _____

17. List all the common factors of 15 and 30.

Ans: _____

18. What is the missing number in the box?

36 : 81 = : 9

Ans: _____

19. Express 20 minutes out of 2 hours as a ratio in the simplest form.

Ans: _____

20. Express $2\frac{4}{9}$ as a decimal correct to 2 decimal places.

Ans: _____

21. How many **more** rectangles must be shaded such that the number of shaded rectangles is $\frac{2}{3}$ the total number of rectangles?

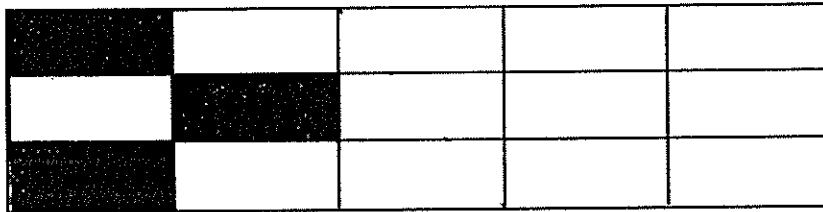

Ans: _____

22. Insert a pair of brackets, (), anywhere in the mathematical expression below to make it true.

$$25 + 10 + 12 \div 11 = 27$$

23. The price of an apartment is a 6-digit whole number. When this price is rounded off to the nearest \$1000, the amount is \$670 000. What could be the highest possible price of the apartment?

Ans: \$ _____

24. Using the number cards provided below, form the greatest 4-digit odd number. Each digit can only be used once.



Ans: _____

25. Marcus bought $\frac{7}{8}$ litres of orange juice. He drank $\frac{1}{3}$ of the orange juice. How much orange juice did Marcus have left?

Ans: _____ litres

Questions 26 to 30 carry 2 marks each. Show your working clearly in the space provided for each question and write your answers in the spaces provided. For questions which require units, give your answers in the units stated.

26. The ratio of the number of boys to the number of girls in a school was 7 : 13 . There were 390 more girls than boys. How many pupils were there in the school?

Ans: _____ pupils

27. Mr. Tan is 40 years old. He is eight years older than Mrs. Tan. Find the ratio of Mr. Tan's age to their total age in the simplest form.

Ans: _____

28. In the number line below, find the fraction exactly halfway between $\frac{1}{8}$ and $\frac{1}{6}$

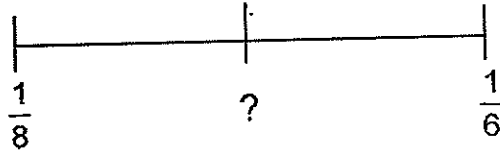

Ans: _____

29. 6 similar bottles of water can fill $\frac{3}{5}$ of a water tank.
3 similar bottles and 4 similar cups of water can fill $\frac{2}{5}$ of the water tank
How many cups of water are needed to fill an identical empty water tank to its brim?

Ans: _____ cups

30. In a music class, Amy rings a bell once every 2 seconds while Clare claps once every 3 seconds. At 8 a.m., the timer starts (none of them rings or claps at 8 a.m.). How many times can a ring and a clap be heard together 31 seconds after 8 a.m.?

Ans: _____

END OF PAPER 1



NAN HUA PRIMARY SCHOOL
SEMESTRAL ASSESSMENT 1 – 2014
PRIMARY 5

MATHEMATICS

Paper 2

Total Time for Paper 2: 1 hour 40 minutes

5 Short Answer Questions (10 marks)

13 Structured / Long Answer Questions (50 marks)

INSTRUCTION TO CANDIDATES

1. Write your name and index number in the space provided.
2. Do not turn over the page until you are told to do so.
3. Follow all instructions carefully
4. Answer all questions and show your workings clearly.
5. You are allowed to use a calculator.

Marks Obtained

Total		/ 60
-------	--	------

Name : _____ ()

Class : 5 _____

Date : 16 May 2014

Parent's Signature : _____

Paper 2 (60 marks)

Questions 1 to 5 carry 2 marks each. Show your workings clearly in the space below it and write your answer in the space provided. Give your answers in the units stated.

1. Shade 2 more squares to make the figure symmetrical along the line XY.

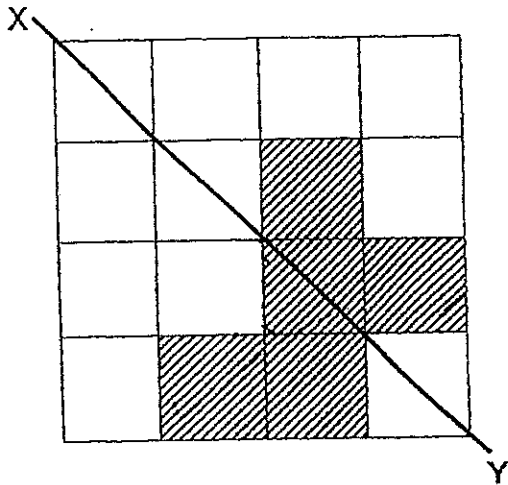

2. When a number is divided by 5, the remainder is 2. When the same number is divided by 6, the remainder is 1.
What is this number if it is more than 30 but less than 40?

Ans: _____

3. The figure, not drawn to scale, shows 2 triangles, ABC and CDE. EB is 12 cm and AD is 10 cm. Find the total area of triangle ABC and triangle CDE.

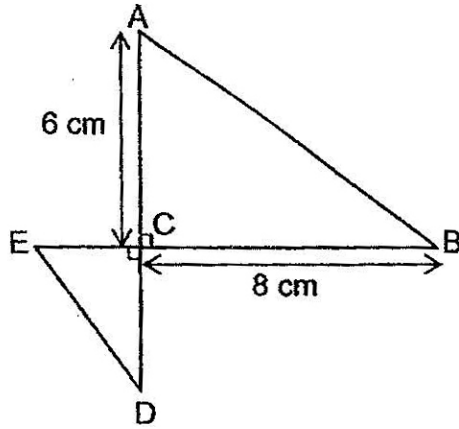

Ans: _____ cm²

4. Jon and Stanley had some stickers each.

$\frac{3}{5}$ of Jon's stickers is equal to $\frac{6}{7}$ of Stanley's stickers.

What is the ratio of Stanley's total number of stickers to Jon's total number of stickers?

Ans: _____

5. The table below shows the postage rates for sending parcels to Country A.

Air Rate	Postage
First 5 kg	\$30
Every additional 1 kg or part thereof	\$5

What is the postage for a parcel of mass 6 kg 250 g sent to Country A?

Ans: \$ _____

For questions 6 to 18, show your working clearly in the space provided for each question and write your answer in the spaces provided. The number of marks available is shown in brackets [] at the end of each question or part-question.

- 6 There were some motorcycles and cars in a carpark. There was a total of 56 vehicles and 158 wheels. How many cars were there?

Ans: _____ [3]

7. For every \$5 Melissa saved, her mother gave her another \$2.
How much money was saved by Melissa if she had a total of \$179
in the end?

Ans: _____ [3]

8. Anita spent $\frac{3}{7}$ of her money on some toys and $\frac{1}{2}$ of the remaining money on some stationery.

- (a) What fraction of her money did she spend on stationery?
(b) If she was left with \$55, how much money did she have at first?

Ans: (a) _____ [1]

(b) _____ [2]

9. Angeline has \$8. Belinda has \$12 more than Angeline. Belinda has \$6 less than Cindy.

Find the ratio of Cindy's share to Belinda's share.

Give your answer in the simplest form.

Ans: _____ [3]

10. The figure below, not drawn to scale, shows a field which is surrounded by a path. The field has a 3m path surrounding it. Find the area of the path.

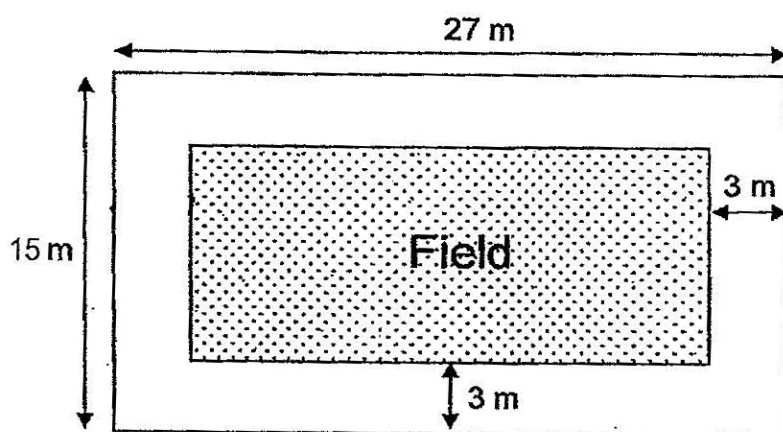

Ans: _____ [3]



11. Tom had 90 more marbles than Jerry at first. After Tom gave 105 marbles to Jerry, Jerry had 6 times as many marbles as Tom. Find the number of marbles Tom had at first.

Ans: _____ [4]

12. The ratio of Paul's savings to Smith's savings was 5 : 7. If Paul saved \$27 more and Smith spent \$5, they would have the same amount of money. How much was Smith's savings ~~at first?~~

Ans: _____ [4]

13. Josh's auntie is thrice of Josh's age now.

Their combined age 4 years ago was 60.

- (a) How old is Josh's auntie now?
- (b) What is the ratio of Josh's age to his auntie's age 3 years from now? Give your answer in the simplest form.

Ans: (a) _____ [2]

(b) _____ [2]

14. Amy had some beads. She used $\frac{3}{5}$ of them on Monday and $\frac{7}{8}$ of the rest on Tuesday. She bought another 399 beads and then had as many beads as she had at first. How many more beads did she use on Monday than Tuesday?

Ans: _____ [4]



15. Study the pattern carefully and answer the questions that follow.

Pattern 1

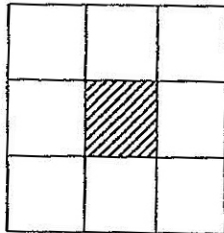

Pattern 2

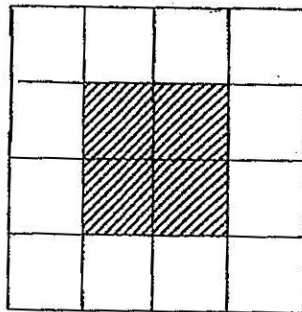

Pattern 3

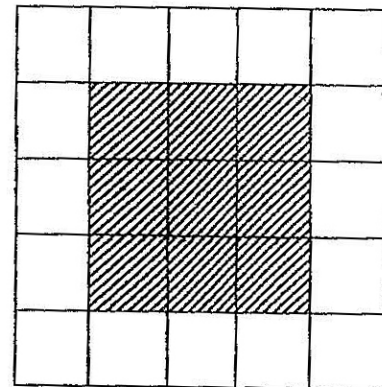

- (a) How many shaded squares are there in Pattern 5?
- (b) How many unshaded squares are there in Pattern 5?
- (c) In which pattern would there be 196 unshaded squares?

Ans: (a) _____ [1]

(b) _____ [1]

(c) _____ [2]

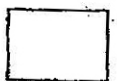

16. There were five times as many boys as girls in a party. Each boy received 3 sweets and each girl received 7 sweets. There was a total of 792 sweets. Find the number of boys who were present.

Ans: _____ [5]

17. The figure below, not drawn to scale, is made up of a square and a rectangle. $\frac{1}{4}$ of the square and $\frac{2}{11}$ of the rectangle is shaded. The area of the rectangle is 54 cm^2 larger than the square.
- (a) Find the area of the rectangle.
- (b) Find the area of the figure.

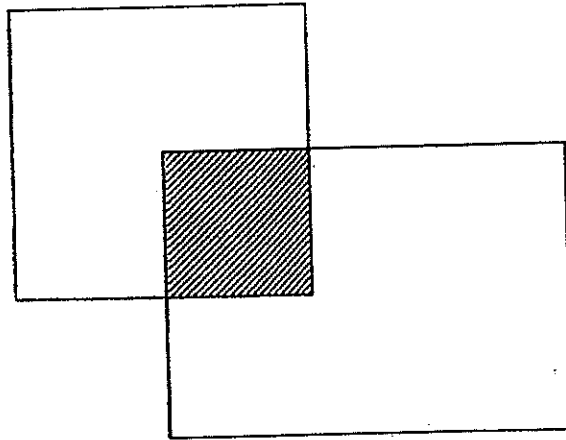

Ans: (a) _____ [3]

(b) _____ [2]

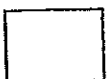

18. Jennifer bought some boxes of pineapple tarts and almond biscuits for Chinese New Year. She spent a total of \$540 on the pineapple tarts and a total of \$510 on the almond biscuits. Each box of almond biscuits cost \$5 more than each box of pineapple tarts. She bought $\frac{2}{3}$ as many boxes of almond biscuits as pineapple tarts. Find the cost of each box of almond biscuits.

Ans: _____ [5]



END OF PARER 2

Nan Hua Primary School
Semestral Assessment 1 (2014)
Primary 5

- 1) 2
- 2) 4
- 3) 3
- 4) 1
- 5) 4
- 6) 3
- 7) 4
- 8) 3
- 9) 1
- 10) 2
- 11) 4
- 12) 2
- 13) 2
- 14) 4
- 15) 2
- 16) 1375g
- 17) 1, 3, 5 & 15
- 18) 4
- 19) 1 : 6
- 20) 2.44
- 21) 7
- 22) $25 + (10 + 12) / 11 = 27$
- 23) \$670 499
- 24) 9405
- 25) $7/12$
- 26) $13u - 7u = 6u$
 $390/6 = 65$
 $13u + 7u = 20u$
 $20 * 65 = 1300$ pupils
- 27) $40 - 8 = 32$
 $40 : 32 + 40$
 $5 : 9$
- 28) $1/8 + 1/6 = 7/24$
 $(7/24) / 2 = 7/48$

29)

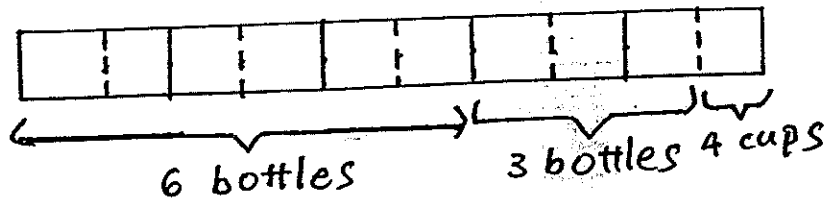

$$10 \times 4 = 40 \text{ cups}$$

30) Common multiple of 2 & 3 = 6

$$31/6 = 5 \text{ R}1$$

So, a ring & a clap can be heard together 5 times.

Paper 2

1)

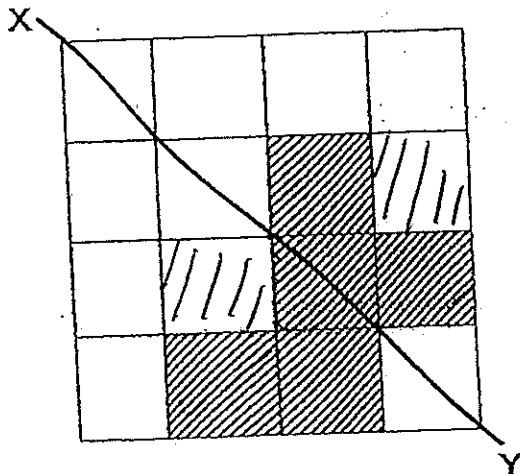

2) Multiples of 6+1 > 30....37

Multiples of 5+2 > 30...32, 37

Hence common number is 37

3) $1/2 \times 8 \times 6 = 24 \text{ sq cm}$

$$12 - 8 = 4$$

$$10 - 6 = 4$$

$$1/4 \times 4 \times 4 = 8$$

$$24 + 8 = 32 \text{ sq cm}$$

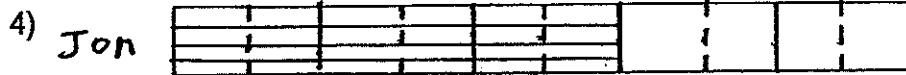

7 : 10

- 5) $6.25\text{kg} - 5\text{kg} = 1.25\text{kg}$
 Therefore, will have pay for additional 2kg postage
 $2\text{kg} * \$5 = \10
 $\$30 + \$10 = \$40$

- 6) Assume all are motorcycles.
 $56 * 2 = 112$
 $158 - 112 = 46$ (number of wheels short)
 $4 - 2 = 2$ (excess wheels)
 $46 / 2 = 23$ cars

- 7) $5 + 2 = 7$ (1 set)
 $179 / 7 = 25 \text{ R}4$ (25 sets with \$4 left over)
 $25 * 5 = \$125$
 $\$125 + \$4 = \$129$

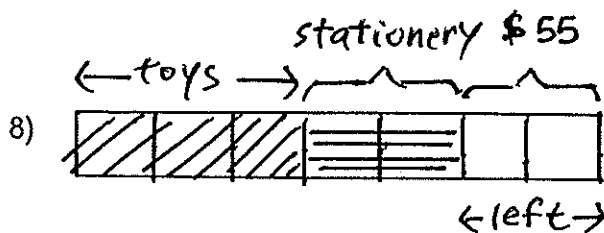

- a) $2/7$
 b) $\$55 / 2 = \27.50
 $\$27.50 * 7 = \192.50

- 9) Amount of money Belinda has = $\$12 + \$8 = \$20$
 Amount of money Cindy has = $\$20 + \$6 = \$26$
 C : B
 $26 : 20$
 $13 : 10$

- 10) Area of field & path = $27 \times 15 = 405$ m
 Length of field = $27 - 3 - 3 = 21$ m
 Breadth of field = $15 - 3 - 3 = 9$ m
 Area of field = $21 \times 9 = 189$ sq m
 Therefore area of path = $405 - 189 = 216$ sq m

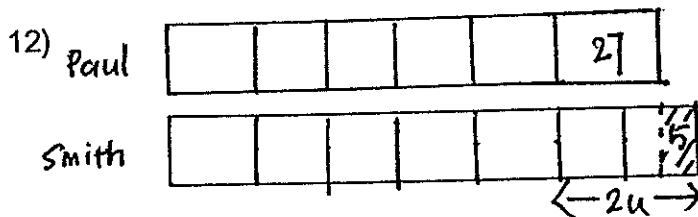
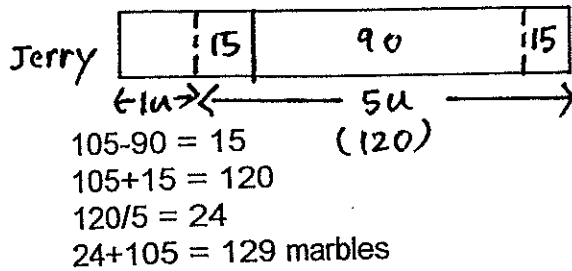
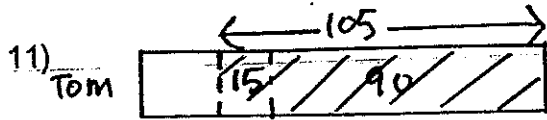

$\$27 + \$5 = \$32$
 $\$32 / 2 = \16
 $\$16 \times 7 = \112 (Smith's savings)

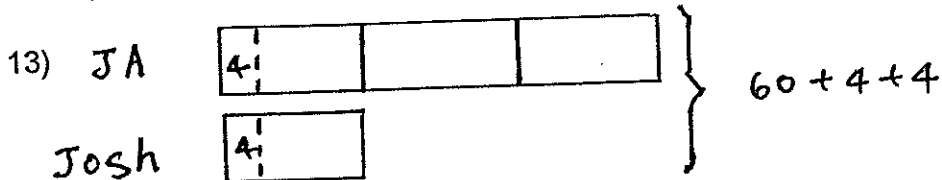

- a) $60 + 4 + 4 = 68$ (present combined age)
 $68 / 4 = 17$ (Josh's present age)
 $17 \times 3 = 51$ years old (Aunt's present age)
- b) $17 + 3 = 20$
 $51 + 3 = 54$
 $20 : 54$
 $10 : 27$

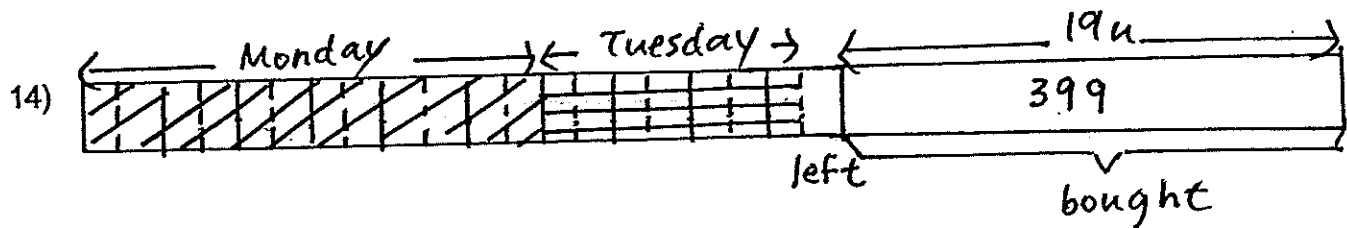

Original number of units = $5 \times 4 = 20$

$20 - 1 = 19$ units

$399 / 19 = 21$

$21 \times 5 = 105$

15a) For the shaded squares, the pattern is pattern number multiplied by pattern number

Hence, $5 \times 5 = 25$

b) For the unshaded squares, the pattern is to pattern number multiplied by 4, then plus 4

Hence, $5 \times 4 + 4 = 24$ unshaded squares

c) $196 - 4 = 192$

$192 / 4 = 48$

16) $5 \times 3 = 15$

$1 \times 7 = 7$

$15 + 7 = 22$

$792 / 22 = 36$ groups

$36 \times 5 = 180$ boys

17) Shaded region of rectangle = $2/11$

a) Since shaded region is common in both shapes, the common numerator is 2 units.

Shaded region of square = $1/4 = 2/8$

$11u - 8u = 3u$

$54 / 3 = 18$

$11 \times 18 = 198$ sq cm

b) Area of figure = $11u + (8u - 2u) = 17u$

$17 \times 18 = 306$ sq cm

18) Cost of $2u$ of almond biscuits = \$510

Cost of $1u$ of almond biscuits = $\$510 / 2 = \255

Cost of 3 units of pineapple tarts = \$540

Cost of 1 unit of pineapple tarts $\$540 / 3 = \180

Difference in 1 unit cost = $\$255 - \$180 = \$75$

Number of boxes in 1 unit = $75 / 5 = 15$

Number of boxes of almond biscuits = $15 \times 2 = 30$

Cost of 1 box of almond biscuits = $\$510 / 30 = \17

