



**Rosyth School**  
**First Semestral Assessment 2014**  
**Primary 5 Mathematics**

Name: \_\_\_\_\_ Register No. \_\_\_\_\_

Class: Pr 5 - \_\_\_\_\_

Date: 12<sup>th</sup> May 2014 Parent's Signature: \_\_\_\_\_

Total Time for Booklets A and B : 50 minutes

---

**PAPER 1**  
**(Booklet A)**

Instructions to Pupils:

1. Do not open this booklet until you are told to do so.
2. Follow all instructions carefully.
3. Shade your answers in the Optical Answer Sheet (OAS) provided.
4. You are not allowed to use a calculator
5. Answer all questions.

Section	Maximum Mark	Marks Obtained
Paper 1 (Booklet A)	20	

\* This booklet consists of 7 pages (including this cover page)

This paper is not to be reproduced in part or whole without the permission of the Principal.

Questions 1 to 10 carry 1 mark each. Questions 11 to 15 carry 2 marks each. For each question, four options are given. One of them is the correct answer. Make your choice (1, 2, 3 or 4). Shade the oval (1, 2, 3 or 4) on the Optical Answer Sheet.

(20 marks)

---

1. Seven million, twenty thousand and twenty written in numeral is \_\_\_\_\_.

(1) 7 020 020

(2) 7 020 000

(3) 7 200 020

(4) 7 220 000

2. Which one of the following fractions has the biggest value?

(1)  $\frac{1}{3}$

(2)  $\frac{3}{5}$

(3)  $\frac{4}{7}$

(4)  $\frac{6}{11}$

3. Express 50.g as a fraction of 1.5 kg.

(1)  $\frac{3}{10}$

(2)  $\frac{1}{30}$

(3)  $\frac{3}{100}$

(4)  $\frac{1}{300}$

4. Round off 189 550 to the nearest ten thousands.

- (1) 180 000
- (2) 189 000
- (3) 190 000
- (4) 200 000

Which one of the following is a common factor of 12, 16 and 20?

- (1) 5
- (2) 6
- (3) 3
- (4) 4

6. Melvin bought a television set at a sale. He gave the cashier \$1 000 and received \$245.80 as change. How much did the television set cost?

- (1) \$ 754.20
- (2) \$ 765.20
- (3) \$ 865.20
- (4) \$ 1 245.80

7. Which of the following shapes can be tessellated?

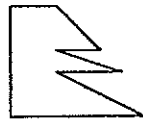

A

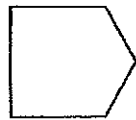

B



C



D

- (1) A and B
- (2) B and C
- (3) B and D
- (4) D only

8. The graph below shows the number of erasers that 4 classmates have.

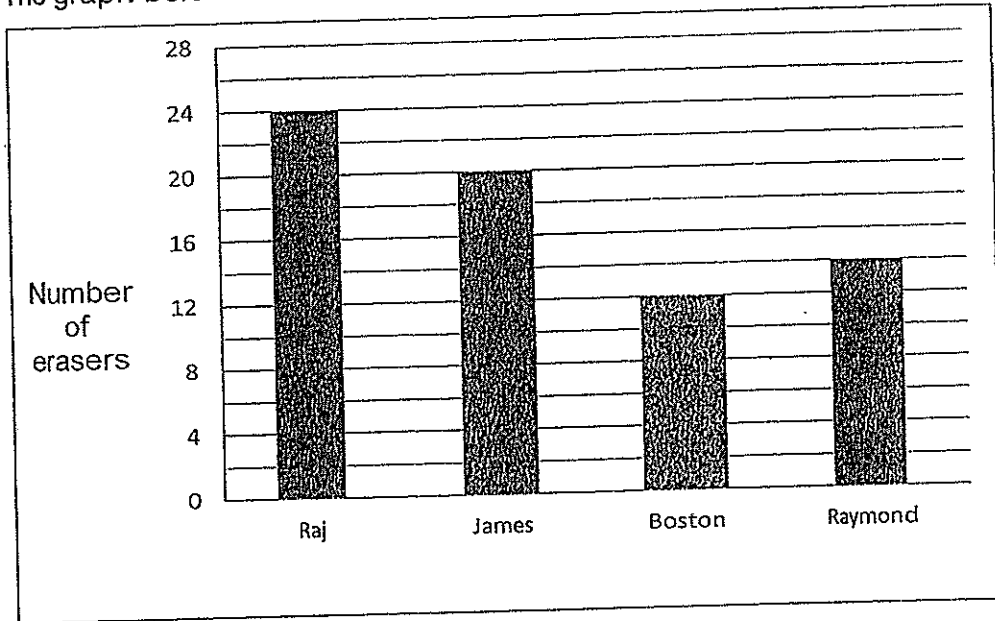

How many erasers must James give away so that he will have the same number of erasers as Raymond?

- (1) 6
  - (2) 7
  - (3) 3
  - (4) 4
9. There are 8 red, 11 blue and 7 yellow stickers. Find the ratio of the number of red stickers to the total number of stickers.
- (1) 4 : 9
  - (2) 4 : 13
  - (3) 11 : 15
  - (4) 19 : 7

10. The ratio of Shirley's savings to Marie's savings is 5 : 3. If Shirley's savings is \$30, what is their total savings?

- (1) \$18
- (2) \$48
- (3) \$50
- (4) \$120

11. The table below shows the number of completed hours of community service done by students in a class.

Number of students in class	6	12	11	5	6
Number of completed hours per student	1	0	2	1	4

Find the total number of hours of community service completed by the class.

- (1) 28 h
- (2) 40 h
- (3) 57 h
- (4) 126 h

12. Mrs Tan used  $\frac{4}{5}$  of a packet of sugar to bake some cakes in 4 days. She used the same amount of sugar each day. How many packets of sugar did she use in 4 weeks?
- (1)  $\frac{1}{5}$
- (2)  $\frac{4}{5}$
- (3)  $3\frac{1}{5}$
- (4)  $5\frac{3}{5}$
13. Samad received \$360 for this month's allowance. He saved  $\frac{2}{5}$  of it and spent  $\frac{1}{4}$  of the remaining money on food. The rest were given to his parents. How much money did Samad give his parents?
- (1) \$54
- (2) \$144
- (3) \$162
- (4) \$210
14. Lishan and Aminah bought some cookies in the ratio of 3 : 4. Aminah gave 9 cookies to Lishan. Then the ratio of the number of cookies Lishan had to that of Aminah was 1 : 1. How many cookies did they have at first?
- (1) 54
- (2) 63
- (3) 72
- (4) 126

15. The ratio of the length to the breadth of a rectangular cardboard is 5 : 2.  
Find the area of the rectangular board if its breadth is 6 cm shorter than its length.

- (1)  $14 \text{ cm}^2$
- (2)  $28 \text{ cm}^2$
- (3)  $40 \text{ cm}^2$
- (4)  $90 \text{ cm}^2$



**Rosyth School**  
**First Semestral Assessment 2014**  
**Primary 5 Mathematics**

Name: \_\_\_\_\_ Register No. \_\_\_\_\_

Class: Pr 5 - \_\_\_\_\_

Date: 12<sup>th</sup> May 2014

Parent's Signature: \_\_\_\_\_

Total Time for Booklets A and B : 50 minutes

---

**PAPER 1**  
**(Booklet B)**

Instructions to Pupils:

1. Do not open this booklet until you are told to do so.
2. Follow all instructions carefully.
3. You are **not** allowed to use a calculator
4. Answer all questions.

Section	Maximum Mark	Marks Obtained
Paper 1 (Booklet B)	20	

**\* This booklet consists of 7 pages (including this cover page)**

This paper is not to be reproduced in part or whole without the permission of the Principal.



Questions 16 to 25 carry 1 mark each. Write your answers in the spaces provided.  
For questions which require units, give your answers in the units stated.  
(10 marks)

---

16. Find the value of  $90 \times 0.8$ .

Ans: \_\_\_\_\_

17. Find the value of  $200 + (28 - 8) \div 5 \times 2$ .

Ans: \_\_\_\_\_

18. The ratio of the number of apples to the number of mangoes is 5 : 11.  
What fraction of the fruits are mangoes?

Ans: \_\_\_\_\_

19.  $\boxed{A} : 72 : 64 = 7 : 9 : \boxed{B}$

What are the values of A and B?

Ans: A: \_\_\_\_\_

B: \_\_\_\_\_

20. The figure below is made up of a square ABGH and 3 similar rectangles. The length of AB is 12 cm, find the length of DE.

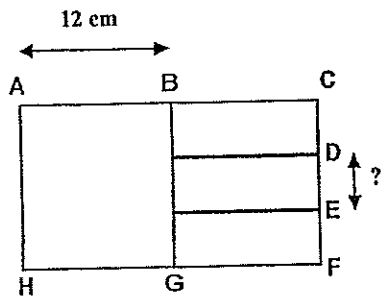

Ans: \_\_\_\_\_ cm

21. Container A weighs 45 kg. Container B weighs 19 kg more than Container A. What is the average mass of the two containers?

Ans: \_\_\_\_\_ kg

22. Damien gave away 72 marbles and had  $\frac{7}{9}$  of his marbles left. How many marbles did he have at first?

Ans: \_\_\_\_\_

23. Jane bought 20 packets of sugar. Each packet was  $1\frac{1}{4}$  kg. How much sugar did she buy?

Ans: \_\_\_\_\_ kg

24. Melvin marked points A, B, C and D on a straight line. The ratio of AB to AC is 3 : 4. The ratio of AC to AD is 2 : 3. What is the ratio of AB to AD?

Ans: \_\_\_\_\_

25. The bar graph shows the amount of rainfall over the last 4 months in Singapore. The bar that shows the amount of rainfall in May has not been drawn.

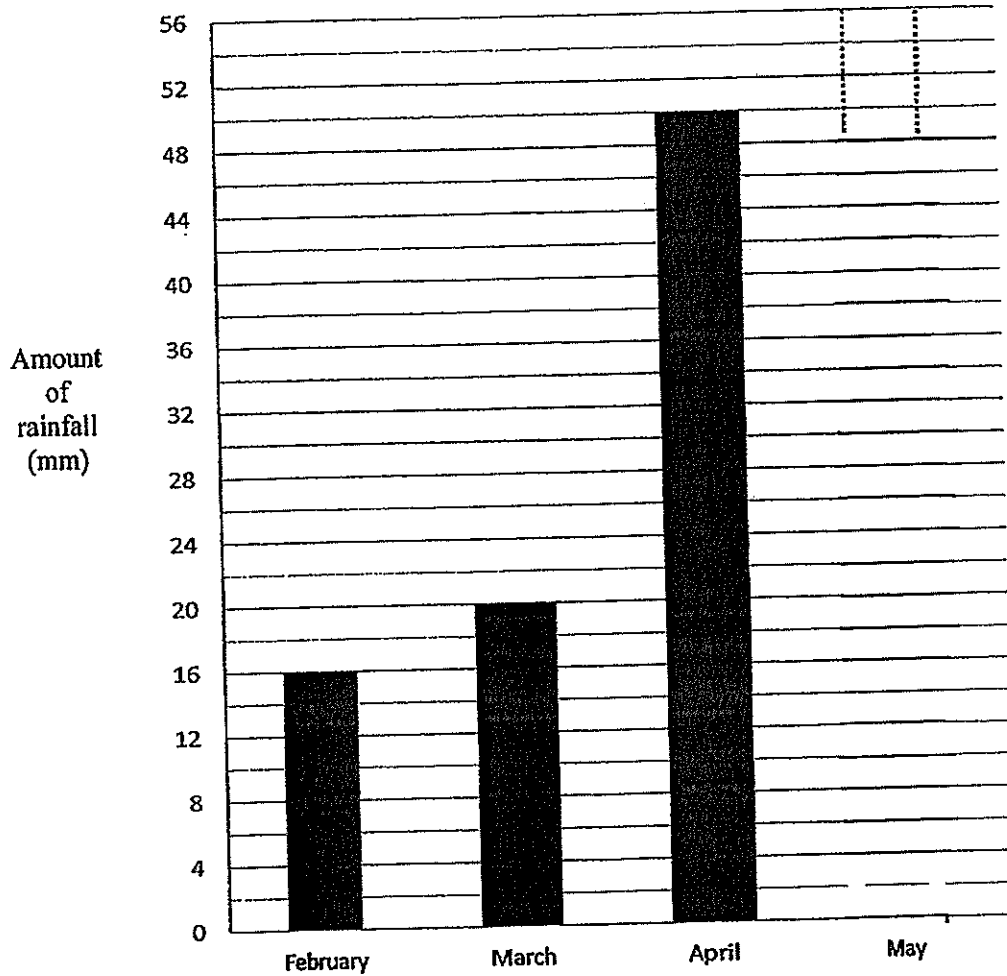

The bar representing the amount of rainfall in May was thrice that of February. Draw the bar representing the amount of rainfall in May in the bar graph above. You are not required to shade the bar.

Questions 26 to 30 carry 2 marks each. Show your workings clearly in the space provided for each question and write your answers in the spaces provided. For questions which require units, give your answers in the units stated.

(10 marks)

26. In the figure below, XY is the line of symmetry. Complete the figure.

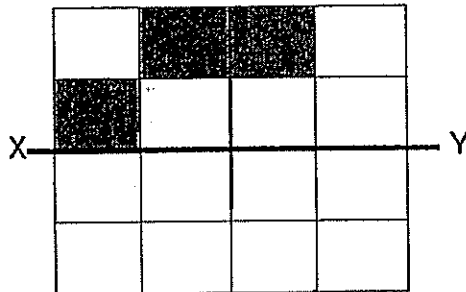

27. Tina had some fruits. She gave  $\frac{4}{9}$  of her fruits to her neighbour. She gave the rest of the fruits to 10 classmates. What fraction of the fruits did each of her classmates get? Leave your answer in the simplest form.

Ans: \_\_\_\_\_

28. John had  $\frac{1}{3}$  as many toy cars as Tom. Ben had 13 more toy cars than Tom. John gave  $\frac{1}{2}$  of his toy cars to Ben and had 5 toy cars left. How many toy cars did Ben have now?

Ans: \_\_\_\_\_

29. There were some chairs in the hall. Aini arranged all the chairs to form 24 rows. Each row had the same number of chairs except the last row which had only 4 chairs. Aini sat on a chair in one of the rows. There were 3 chairs to her right and 5 chairs to her left. How many chairs were there in the hall altogether?

Ans: \_\_\_\_\_

30. Bobby had \$500 more than Kumar. After Kumar gave Bobby \$30, Kumar had  $\frac{1}{3}$  of what Bobby had. How much did Kumar have at first?

Ans: \$\_\_\_\_\_

**End of Booklet B**



**Rosyth School**  
**First Semestral Assessment 2014**  
**Primary 5 Mathematics**

Name: \_\_\_\_\_ Register No. \_\_\_\_\_

Class: Pr 5 - \_\_\_\_\_

Date: 12<sup>th</sup> May 2014

Parent's Signature: \_\_\_\_\_

Time: 1 h 40 min

---

**PAPER 2**

Instructions to Pupils:

1. Do not open this booklet until you are told to do so.
2. Follow all instructions carefully.
3. **Show your workings clearly** as marks are awarded for correct working.
4. Write your answers in this booklet.
5. You are allowed to use a calculator
6. Answer all questions.

Questions	Maximum Mark	Marks Obtained
Q 1 to 5	10	
Q 6 to 18	50	

Section	Maximum Mark	Marks Obtained
Paper 1	40	
Paper 2	60	
Total	100	

**\* This booklet consists of 14 pages (including this cover page)**

This paper is not to be reproduced in part or whole without the permission of the Principal.

Questions 1 to 5 carry 2 marks each. Show your working clearly in the space provided for each question and write your answers in the spaces provided. For questions which require units, give your answers in the units stated.

Do not write in this space

(10 marks)

1. Four pupils scored the following marks for their Math Test.

Malcom	67
Tai Seng	87
Siti	92
Adam	70

What was the average mark of the 4 pupils?

Ans: \_\_\_\_\_

2. A rectangular piece of paper is folded to form a rectangle, triangle and square as shown below. Find the length of the rectangular piece of paper before it was folded.  
(Figure is not drawn to scale)

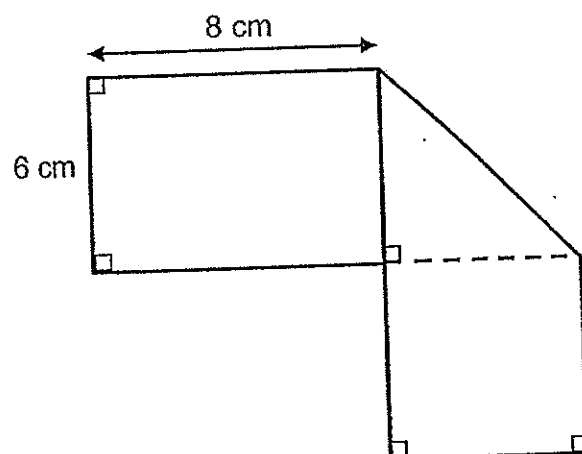

Ans: \_\_\_\_\_ cm



3. The line graph below shows the number of durians that Mr Ahmad sold from May to August.

Do not write  
in this space

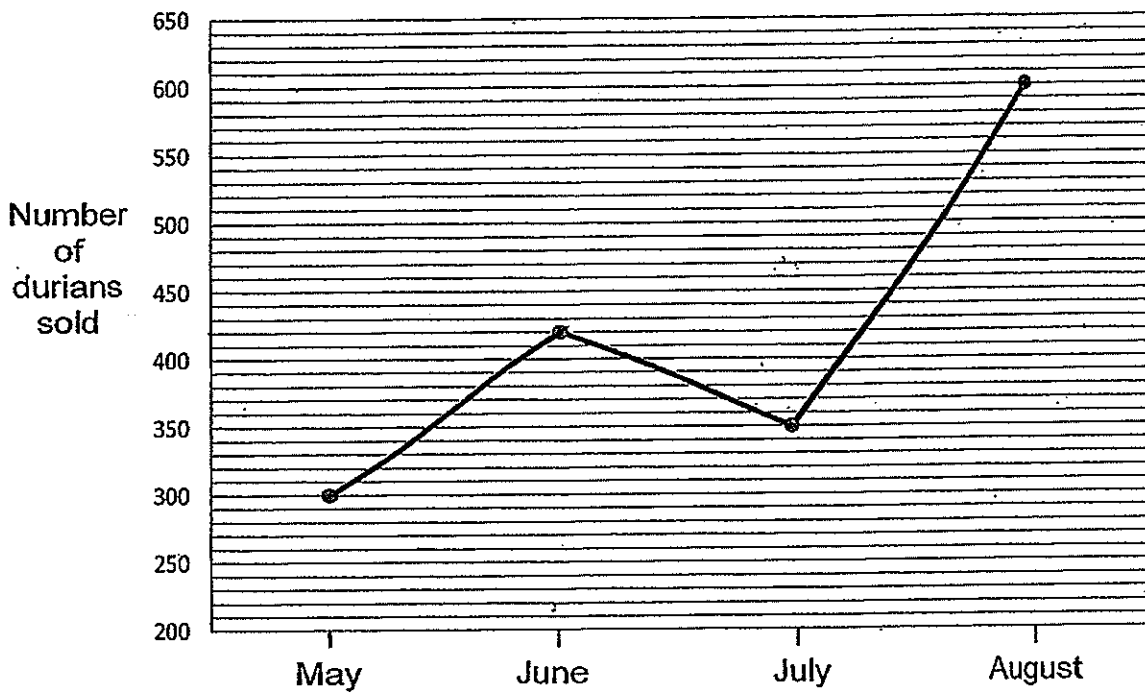

Mr Ahmad sold each durian for \$6.50. What was the total amount of money he earned from May to August?

Ans: \$ \_\_\_\_\_

4. Jun Xiang decorates his bedroom wall with green and yellow stickers.

For every 11 green stickers, there will be 3 yellow stickers.

If there are 96 yellow stickers, what is the total number of stickers used to decorate the bedroom wall?

Do not write  
in this space

Ans: \_\_\_\_\_

---

5. An empty container has a mass of 10 kg. It has a mass of 61.36 kg when  $\frac{1}{2}$  filled with water. What is the mass of the container when it is  $\frac{1}{3}$  full of water?

Ans: \_\_\_\_\_ kg

Questions 6 to 18, show your working clearly in the space provided for each question and write your answers in the spaces provided. The number of marks available is shown in brackets [ ] at the end of each question or part-question.

(50 marks)

Do not write  
in this space

- 
6. The average height of Li Shan, Shanti and Aminah is 1m 15 cm. Li Shan is 10 cm taller than Shanti and Aminah is 8 cm taller than Shanti. What is Shanti's height?

Ans: \_\_\_\_\_ [3m]

- 
7. In the class library,  $\frac{3}{5}$  of the books are fiction books.  $\frac{2}{3}$  of the remaining books are non-fiction books. The rest are magazines. There are 10 fewer magazines than non-fiction books in the class library. How many fiction books are there altogether?

Ans: \_\_\_\_\_ [3m]

Do not write  
in this space

8. There were  $\frac{2}{3}$  as many apples as oranges in a fruit stall. There were  $\frac{2}{5}$  as many oranges as pears in the same fruit stall. If there were 534 oranges in the fruit stall, find the total number of fruits in the fruit stall.

Ans: \_\_\_\_\_ [3m]

---

9. Jolene bought some apples at an average price of \$1.20 each. She bought another 2 apples at \$2.95 each and the average price became \$1.45. How many apples did she buy altogether?

Ans: \_\_\_\_\_ [3m]

---

Do not write  
in this space

10. Mei Ting wanted to buy some files which were of the same price. If she ~~buy~~ 18 such files, she would have \$18 left over. If she ~~buy~~ 22 such files, she would be short of \$16. How much money did Mei Ting have? <sup>bought</sup>

Ans: \_\_\_\_\_ [3m]

---

11. Hassan had \$450.50 and Shi Min had \$1 060.90. Both of them spent the same amount of money on a box of chocolate. In the end, the ratio of the amount of money Shi Min had to the amount of money Hassan had was 12 : 5. How much did each of them spend on the box of chocolate?

Ans: \_\_\_\_\_ [4m]

---

12. The total cost of 5 shirts and 10 blouses is \$745.  
The total cost of 2 shirts and 3 blouses is \$256.  
Find the total cost of 2 shirts and 5 blouses.

Do not write  
in this space

Ans: \_\_\_\_\_ [4m]

13. Mina put 23 potted plants in a row from one end to the other end of the corridor. They were placed at an equal distance from one another. The distance between the first and the fifth potted plant was 28 m. Later, Mina decided to remove 9 potted plants. As a result, the remaining potted plants were rearranged from one end to the other end of the corridor at a new equal spacing.
- a) Find the distance between the first and the last potted plant.
- b) Find the new distance between the 2 potted plants.
- (Correct the answer to 2 decimal places)

Do not write in this space

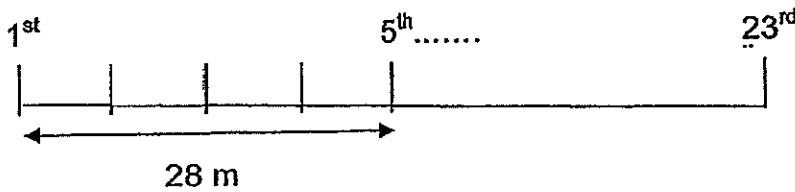

Ans: a) \_\_\_\_\_ [2m]

b) \_\_\_\_\_ [2m]

Do not write  
in this space

14. Ee Ling baked more vanilla cupcakes than chocolate cupcakes.  
She also baked twice as many strawberry cupcakes as chocolate cupcakes.  
After she baked another 72 more chocolate cupcakes, sold 28 vanilla cupcakes  
and half of the strawberry cupcakes, she now had 17 more chocolate cupcakes  
than vanilla cupcakes.  
In the end, there were a total of 256 cupcakes.  
How many vanilla, chocolate and strawberry cupcakes did she bake at first?

Ans: Vanilla: \_\_\_\_\_ }  
Chocolate: \_\_\_\_\_ } [4m]  
Strawberry: \_\_\_\_\_ }



Do not write  
in this space

15. David spent  $\frac{5}{12}$  of his money on some books and Mary spent  $\frac{3}{4}$  of her money on some files.

After paying for their purchases, they had an equal amount of money left.

If David had \$52.50 left, what was the total amount of money David and Mary had at first?

Ans: \_\_\_\_\_ [4m]

16. Study the diagram below.

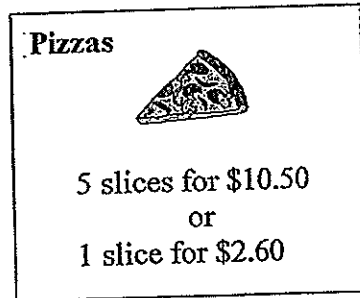

Xiao Ming has \$50.

- (a) What is the maximum number of slices of pizzas that he can purchase?  
(b) How much will Xiao Ming have after paying for the pizzas?

Do not write  
in this space

Ans: (a) \_\_\_\_\_ [3m]

(b) \_\_\_\_\_ [2m]

17. There are different types of flowers in a vase.

$\frac{3}{10}$  of the flowers are roses,  $\frac{2}{5}$  of them are orchids and the rest are sunflowers and lilies.

The number of lilies is half the number of sunflowers.

There are 18 more orchids than sunflowers.

- a) What fraction of the flowers was sunflowers? (Leave your answer in the simplest form)
- b) Find the total number of flowers in the vase.

Do not write  
in this space

Ans: (a) \_\_\_\_\_ [2m]

(b) \_\_\_\_\_ [3m]

Do not write  
in this space

18. Aminah, Bala, Candy, David and Erin each donated some money to charity.

The donation made by Bala was  $\frac{1}{4}$  as much as the total amount donated by all of them.

The ratio of the amount of money donated by Candy to the rest of them was 3 : 17.

David and Erin donated  $\frac{3}{7}$  as much as the total amount donated by the rest of them.

Aminah donated \$1 080 more than Candy.

Find the total amount of money donated to the charity.

Answer: \_\_\_\_\_ [5m]

**End of Paper**

Rosyth School  
First Semestral Assessment 2014  
Primary 5

- 1) 1
- 2) 2
- 3) 2
- 4) 3
- 5) 4
- 6) 1
- 7) 3
- 8) 1
- 9) 2
- 10) 2
- 11) 3
- 12) 4
- 13) 3
- 14) 4
- 15) 3
- 16) 72
- 17) 208
- 18) 11/16
- 19) A : 56  
B : 8
- 20) 4 cm
- 21) 54.5 kg
- 22) 324 marbles
- 23) 25 kg
- 24) 1 : 2
- 25)

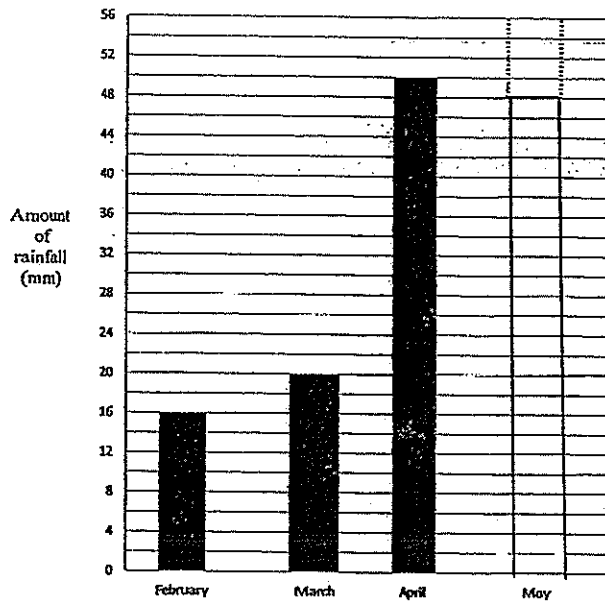

26)

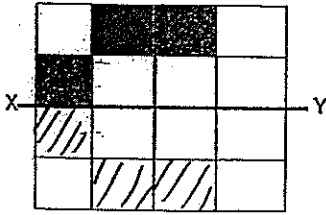

27)  $1 - \frac{4}{9} = \frac{5}{9}$   
 $(\frac{5}{9}) / 10 = \frac{1}{18}$

28)  $5 * 2 = 10$   
 $3 * 10 = 30$   
 $30 + 13 + 5 = 48$

29)  $23 * 9 = 207$   
 $207 + 4 = 211$

30)  $\$560 / 2 = \$280$   
 $\$280 + \$30 = \$310$

### Paper 2

1)  $67 + 87 + 92 + 70 = 316$   
 $316 / 4 = 79$  marks

2)  $8\text{cm} + 6\text{cm} + 6\text{cm} = 20\text{cm}$

3) Total durians sold =  $300 + 420 + 350 + 600 = 1670$   
Total amount earned =  $1670 * \$6.50 = \$10\,855$

4) 3 yellow  $\rightarrow$  11 green  
96 yellow  $\rightarrow$   $96 / 3 * 11 = 352$  green  
 $352 + 96 = 448$  stickers

5)  $61.36 - 10 = 51.36$  kg  
 $51.36 * 2 = 102.72$  kg  
 $102.72 / 3 = 34.24$  kg  
 $34.24 + 10 = 44.24$  kg

6) Lishan

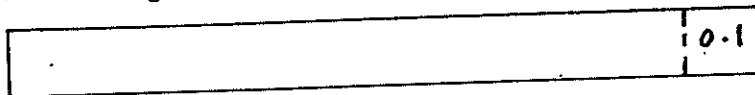

Shanti

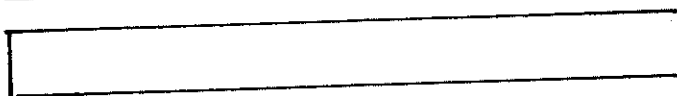

Aminah

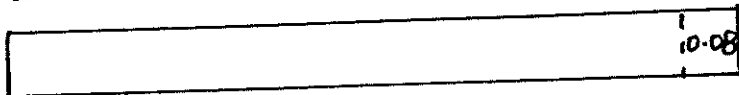

$1.15 * 3 = 3.45$  m  
 $3.45 - 0.1 - 0.08 = 3.27$  m  
 $3.27 / 3 = 1.09$  m

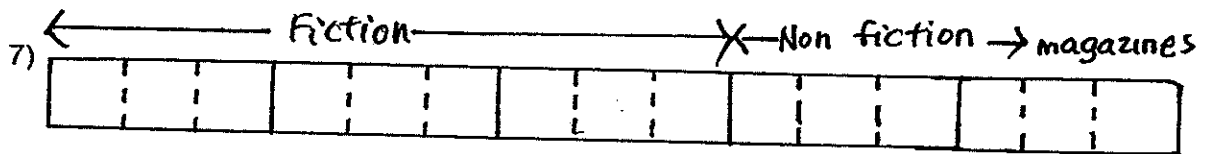

$$10/2 = 5$$

$$15 * 5 = 75 \text{ fiction books}$$

8) A : O : P  
2 : 3  
2 : 5

---

$$4 : 6 : 15$$

$$534/6 = 89$$

$$25 * 89 = 2225 \text{ fruits}$$

9)  $\$1.45 * 2 = \$2.90$   
 $\$2.95 * 2 = \$5.90$   
 $\$5.90 - \$2.90 = \$3$   
 $\$1.45 - \$1.20 = \$0.25$   
 $\$3 / \$0.25 = 12 \text{ apples}$

10)  $22 - 18 = 4$   
 $\$16 + \$18 = \$34$   
 $\$34 / 4 = \$8.50$   
 $\$8.50 * 18 = \$153$   
 $\$153 + \$18 = \$171$

11) Hassan \$450.50

Shi Min \$1060.90

$$\$1060.90 - \$450.50 = \$610.40$$

$$\$610.40 / 7 = \$87.20$$

$$\$87.20 * 5 = \$436$$

$$\$450.50 - \$436 = \$14.50$$

12) 5 shirts + 10 blouses  $\rightarrow$  \$745  
 1 shirt + 2 blouses  $\rightarrow$  \$149  
 2 shirts + 4 blouses  $\rightarrow$  \$298  
 2 shirts + 3 blouses  $\rightarrow$  \$256

---

Difference : 1 blouse  $\rightarrow$  \$42  
 2 blouses  $\rightarrow$   $\$42 * 2 = \$84$

$$1 \text{ shirt} + \$84 \rightarrow \$149$$

$$1 \text{ shirt} \rightarrow \$149 - \$84 = \$65$$

$$2 \text{ shirts} \rightarrow \$65 * 2 = \$130$$

$$\text{Hence } \$130 + \$210 = \$340 \text{ (total cost)}$$

13)  $4u \rightarrow 28 \text{ m}$   
 a)  $1u \rightarrow 28/4 = 7 \text{ m}$   
 $22u \rightarrow 22 * 7 = 154 \text{ m}$

b)  $23-9 = 14$  (new number of pots)  
 $154/13 = 11.85$  m

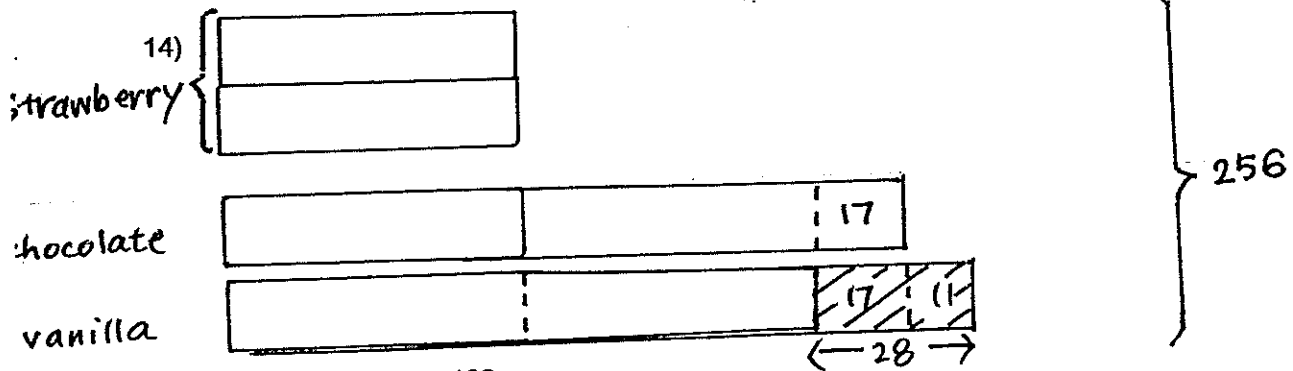

$256-72+28-11-72 = 129$   
 $129/3 = 43$  (chocolate)  
 $43+72+11 = 126$  (vanilla)  
 $43*2 = 86$  (strawberry)

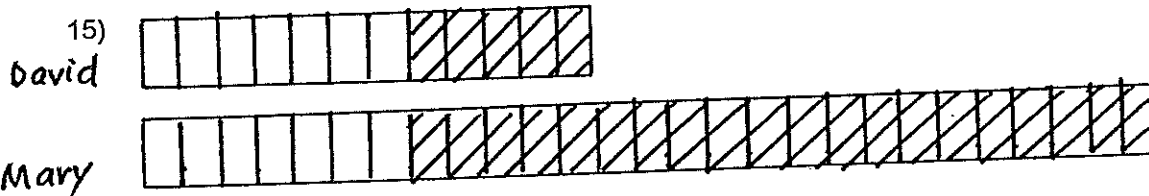

$\$52.50/7 = \$7.50$   
 $\$7.50*40 = \$300$

16)  $50/10.5 = 4$  R 8  
 a)  $8/2.60 = 3$  slices  
 $4*5+3 = 23$  slices  
 b)  $10.50*4 = \$42$   
 $\$2.60*3 = \$7.80$   
 $\$50-\$42-\$7.80 = \$0.20$

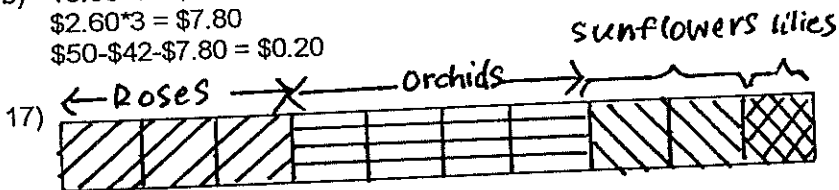

a)  $2/10 = 1/5$   
 b)  $2u \rightarrow 18$   
 $10u \rightarrow 10/2*18 = 90$

18) B : A+B+C+D+E  
 1 : 4  
 C : A+B+D+E  
 3 : 17  
 D+E : A+B+C  
 3 : 7  
 6 : 14  
 Total units of A+B+C+D+E = 20  
 Therefore, B=5, C=3, A=6  
 $3u \rightarrow \$1080$   
 $20u \rightarrow 20/3*1080 = \$7200$