



**NAN HUA PRIMARY SCHOOL
SEMESTRAL ASSESSMENT 2 – 2009
PRIMARY 5**

MATHEMATICS

Paper 1

Section A: 15 Multiple Choice Questions (20 marks)

Section B: 15 Short Answer Questions (20 marks)

Total Time for Paper 1: 50 minutes

INSTRUCTION TO CANDIDATES

1. Write your name and index number in the space provided.
2. Do not turn over the page until you are told to do so.
3. Follow all instructions carefully.
4. Answer all questions.
5. Shade your answers in the Optical Answer Sheet (OAS) provided for Questions 1-15.
6. You are not allowed to use calculator for Paper 1.

Marks Obtained

Paper 1	Booklet A		/ 40
	Booklet B		
Paper 2			/ 60
Total			/ 100

Name : _____ ()

Class : 5 _____

Date : 27 Oct 2009

Parent's Signature : _____

Section A (20 marks)

Questions 1 to 10 carry 1 mark each.

Questions 11 to 15 carry 2 marks each.

For each question, four options are given. One of them is the correct answer.

Make your choice (1, 2, 3 or 4) and shade on the oval (1, 2, 3 or 4) on the Optical Answer Sheet.

1. Find the value of $4\frac{1}{6} - 1\frac{5}{8}$.

(1) $2\frac{1}{24}$

(2) $2\frac{13}{24}$

(3) $3\frac{11}{24}$

(4) $5\frac{19}{24}$

2. In $\square + 20 = 17 \times 10$, what is the missing number in the blank?

(1) 34

(2) 340

(3) 3400

(4) 34 000

3. In the figure below, AB, CD and EF are straight lines. If $\angle c = 54^\circ$, what is $\angle d + \angle e$?

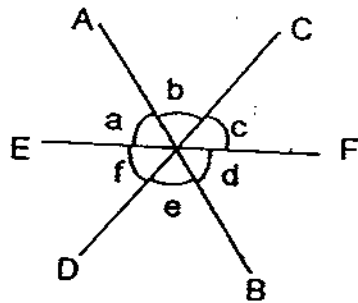

- (1) 54°
- (2) 126°
- (3) 162°
- (4) 306°
4. : 9 = 16 : 12. What is the missing number in the box?
- (1) 27
- (2) 12
- (3) 3
- (4) 4

5. In the triangle below not drawn to scale, if $AB = AC$ and $\angle ACB = 53^\circ$, what is the value of $\angle CAB$?

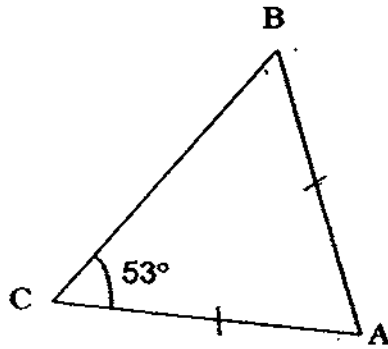

- (1) 74°
(2) 106°
(3) 127°
(4) 254°
6. In the figure below, which pair of lines is most likely to be parallel to each other?

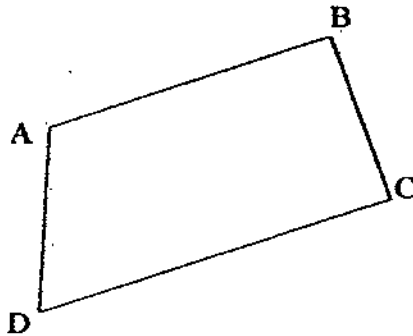

- (1) AB and BC
(2) AB and DC
(3) AD and AB
(4) AD and BC

7. Jolene was standing facing North-east. She then turned 225° anticlockwise. Which direction is she facing now?

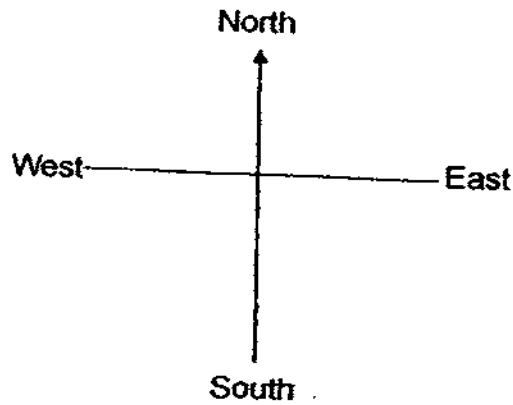

- (1) South
(2) North-east
(3) North-west
(4) West
8. How many pieces of rope, each $\frac{1}{4}$ m long, can be cut from a piece 3 m long?
- (1) 9
(2) 10
(3) 11
(4) 12
9. Find the value of $8\ 000\ 000 + 60\ 000 + 10$.
- (1) 8 006 010
(2) 8 060 001
(3) 8 060 010
(4) 8 600 010

10. $2.16 + 3 = \square$

What is the missing value in the box?

- (1) 0.072
 - (2) 0.72
 - (3) 7.2
 - (4) 72
11. Mrs Phoon bought a camera at a discount of 30 %. She paid \$ 350 for it. What was the original price of the camera?
- (1) \$ 105
 - (2) \$ 245
 - (3) \$ 500
 - (4) \$ 595
12. How many whole 2-cm cubes can be put into a closed box measuring 8 cm by 6 cm by 3 cm?

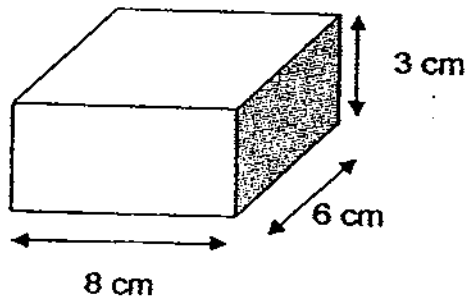

- (1) 12 cubes
- (2) 18 cubes
- (3) 36 cubes
- (4) 72 cubes

13. 5 kg of beef costs \$ 24.60. Find the cost of 500 g of beef.

- (1) \$ 2.46
- (2) \$ 4.92
- (3) \$ 12.30
- (4) \$ 2460

14. The graph below shows the temperature of water over a period of time.

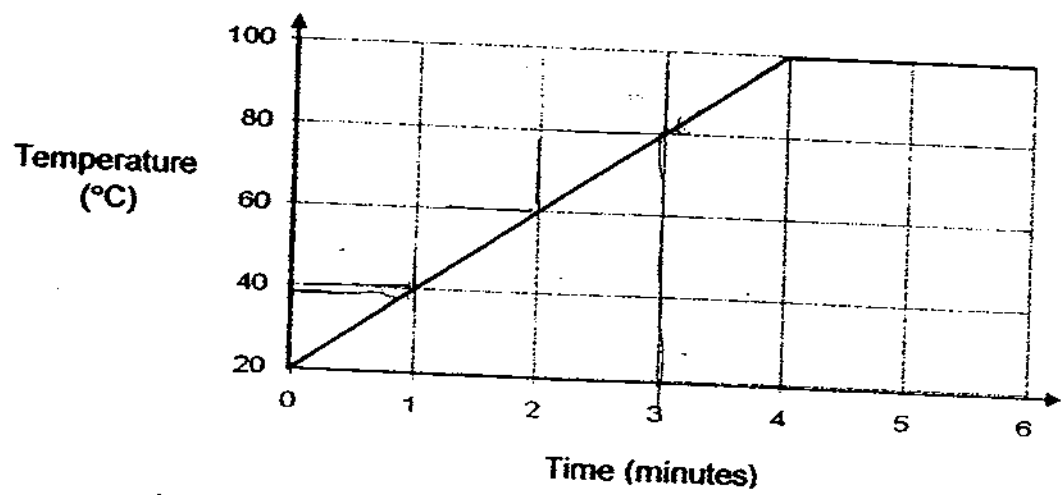





The temperature of the water after 1 minute is 40°C. How much longer will it take to reach 80°C?

- (1) 1 min
- (2) 2 min
- (3) 3 min
- (4) 4 min

15. Study the pattern formed using different fruits below. What is the 98th fruit?



- (1) 
- (2) 
- (3) 
- (4) 

Section B (20 marks)

Questions 16 to 25 carry 1 mark each. Write your answers in the blanks provided. For questions which require units, give your answers in the units stated.

Do not write in this space

[10 marks]

16. Round off the sum of 5.6 and 12.085 to the nearest tenth.

Ans : _____

17. Find all the factors of 15.

Ans : _____

18. How many stars must you shade to show $\frac{3}{4}$ of the set?

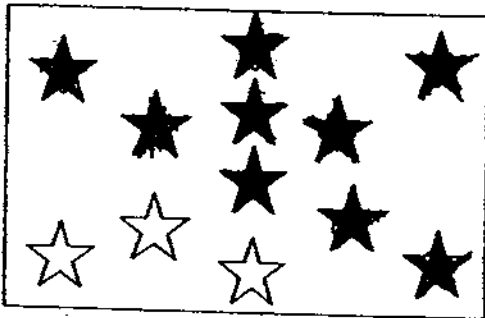

Ans : _____ stars

19. What fraction of the rectangle is shaded? Give your answer in the simplest form.

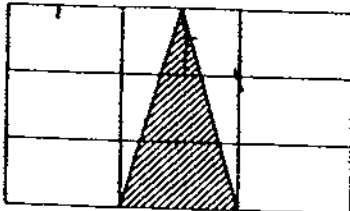

Ans : _____

Do not
write in t
space

20. Yoyo bought a blouse for \$ 36 and a dress that cost \$15. What was the ratio of the cost of the dress to the cost of the blouse? Give your answer in the simplest form.

Ans : _____

21. The price of a camera at a shop without GST is \$ 300 ~~as shown in the figure below~~. Every customer at the shop has to pay a 7% GST on their purchases. How much does a customer actually have to pay for the camera, inclusive of GST?

Ans : \$ _____

22. The volume of a cube is 512 cm^3 . What is the length of one edge of the cube?

Ans : _____ cm

23. What is the length of the key as shown in the figure below?

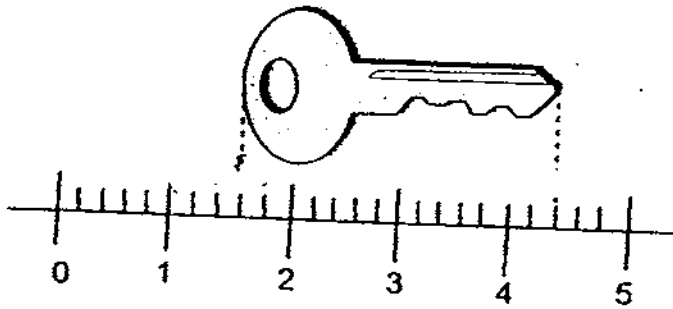

Ans : _____ cm

24. Find the value of $52 \div 7$. Express your answer as a mixed number in its simplest form.

Ans : _____

25. The table below shows the number of points three pupils scored at a computer game.

Pupil	Number of points
Ali	300
Bala	120
Canon	?

If the pupils scored an average of 204 points, how many points did Canon score?

Ans : _____ points

Do not
write in
space

Questions 26 to 30 carry 2 marks each. Show your working clearly in the space provided for each question and write your answers in the spaces provided. For each questions which require units, give your answers in the units stated.

[10 marks]

Do not write in this space

26. What is the missing number in the box?

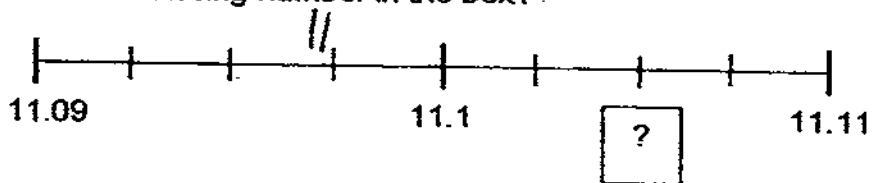

Ans : _____

27. Mrs Richard divided $\frac{5}{8}$ of a pizza into 10 equal pieces. She ate 4 pieces. What fraction of the pizza did she eat? Give your answer in the simplest terms.

Ans : _____

28. The figure ABCD shown below is not drawn to scale.
If ABC is an equilateral triangle and $BC = CD$, find $\angle CAD$.

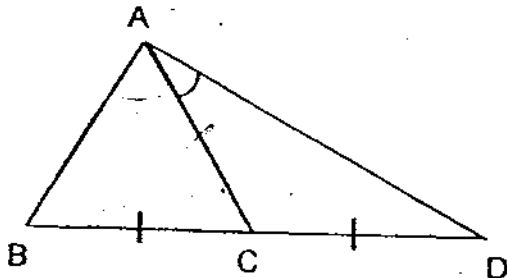

Ans : _____ °

29. Cinderella took 3 days to make 48 paper roses. Each day, she made 2 more paper roses than the previous day. How many paper roses did she make on the second day?

Ans : _____ roses

30. The ratio of the number of marbles Mike has to the number of marbles Priscilla has is 1 : 3. The ratio of the number of marbles Priscilla has to the number of marbles Lydia has is 6 : 7. If Mike has 15 marbles less than Lydia, how many marbles does Priscilla have?

Ans : _____ marbles

Do not
write in
space

END OF PAPER



NAN HUA PRIMARY SCHOOL
SEMESTRAL ASSESSMENT 2 – 2009
PRIMARY 5

MATHEMATICS

Paper 2

Total Time for Paper 2: 1 hour 40 minutes

5 Short Answer Questions (10 marks)

13 Structured / Long Answer Questions (50 marks)

INSTRUCTION TO CANDIDATES

1. Write your name and index number in the space provided.
2. Do not turn over the page until you are told to do so.
3. Follow all instructions carefully
4. Answer all questions and show your workings clearly.
5. You are allowed to use a calculator.

Marks Obtained

Total		/ 60
-------	--	------

Name : _____ ()

Class : 5 _____

Date : 27 Oct 2009

Parent's Signature : _____

Questions 1 to 5 carry 2 marks each. Show your working clearly in the space provided for each question and write your answers in the spaces provided. For questions which require units, give your answers in the units stated. [10 marks]

Do not wr
in this sp

1. Water from the tap flows into a rectangular tank at a rate of 450 cm^3 per minute. How long does it take to fill $\frac{3}{4}$ of the tank?

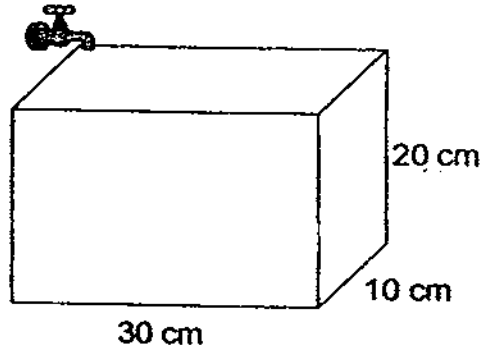

Answer: _____ min

2. The bar graph below shows the average monthly heights of rainfall in Carefree Land in 2008.

Average Monthly Rainfall in Carefree Land

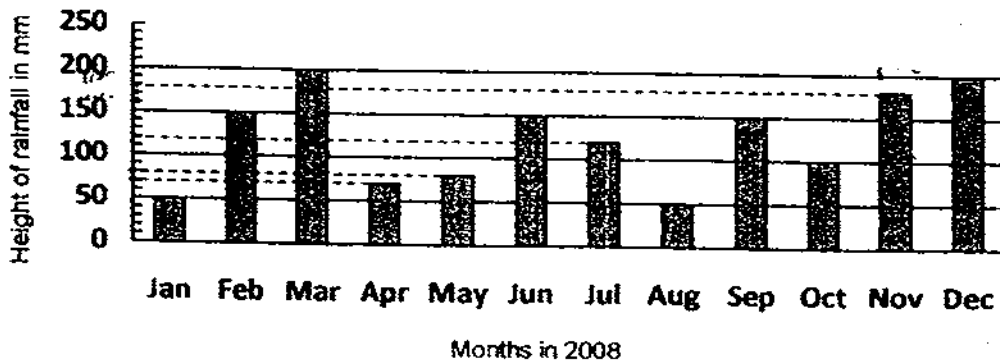

The meteorologist made a wrong report of 20 % less rainfall for the month of November. What should have been the actual average rainfall for the month of November?

Answer: _____ mm

3. What is the value of $1 - 2 + 3 - 4 + 5 - 6 + 7 - 8 \dots + 97 - 98 + 99$?

Do not write
in this space

Answer: _____

4. Samantha's Semestral Assessment 2 result slip was torn accidentally. Part of her Mathematics and Science marks are missing. Given that her total marks was 300 for 4 subjects, what was the smallest possible difference between her Mathematics and Science marks?

Name : Samantha Lee	
Result Slip for SA2	
English	76
Mathematics	8
Science	7
Mother Tongue	63

Answer: _____ marks

5. The side of each square grid is 2 cm. Find the area of the figure ABCD.

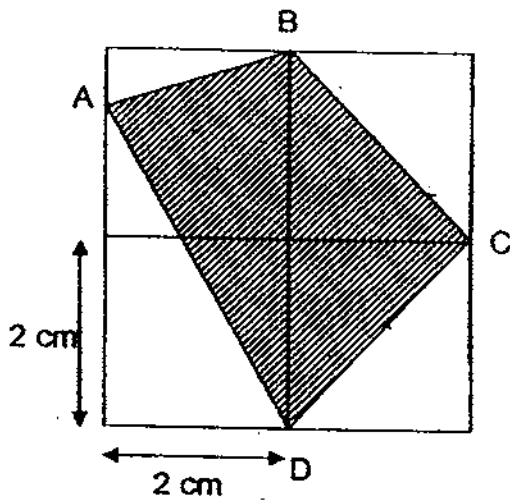

Do not write
in this space

Answer: _____ cm²

For questions 6 to 18, show your working clearly in the space provided for each question and write your answers in the spaces provided. The number of marks available is shown in the brackets [] at the end of each question or part question. [50 marks]

Do not write in this space

6. Tom has 25ℓ of water in a bucket. He pours some of the water into a container measuring 60 cm long, 50 cm wide and 30 cm high. How much water is left in the bucket after he has filled the container with water to a depth of 5 cm? Give your answer in litres.

Ans: _____ [3]

7. In the figure below, not drawn to scale, ABCD is a parallelogram and BEF is a straight line. Find $\angle ABE$.

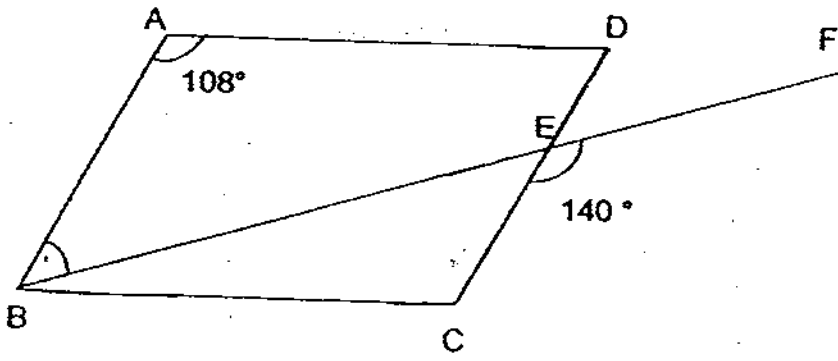

Ans: _____ [3]

8. In a club, $\frac{3}{7}$ of the members are women. $\frac{1}{4}$ of the men like playing tennis. $\frac{5}{9}$ of the women like playing tennis. What fraction of the members like playing tennis?

Do not write in this space

Ans: _____ [3]

9. The table below shows the rate at which a chef is being paid daily at a local café.

Working hours	Rate
First 8 hours	\$8 per hour
Subsequent hours	\$11.50 per hour

The chef works for 11 hours in a day, how much does he earn in 1 day?

Ans: _____ [3]

10. Mother bought a total of 12 books and magazines for \$ 93. She bought 2 more books than magazines. A book costs \$ 3 more than a magazine. How much did she pay for the magazine?

Do not write
in this space

Answer: _____ [3]

11. Gretel had \$ 6.80. This amount of money was just enough to buy 6 oranges and 10 pears. Instead, she bought 10 oranges and 6 pears and had \$ 0.80 left. Find the cost of 1 orange.

Answer: _____ [3]

12. A square paper of area 81 cm^2 is cut into 2 equal pieces as shown in Figure 1. The pieces are arranged to form a rectangle as shown in Figure 2. Find the perimeter of the rectangle.

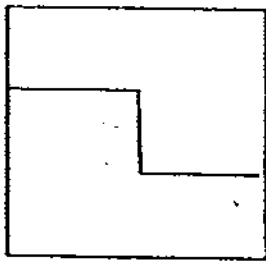

Figure 1

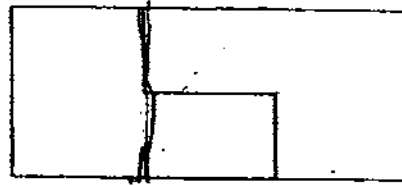
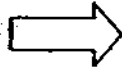

Figure 2

Do not
write in
this space

Ans: _____ [3]

13. The ratio of the number of Faye's balls to the number of Ian's balls was 1 : 5. Then their father gave Ian 12 more balls and Faye 5 more balls. The ratio of the number of Faye's balls to the number of Ian's balls became 1 : 4. How many more balls did Ian have than Faye in the end?

Do not
write in
this space

Ans: _____ [4]

14. Study the following sequence of patterns consisting of dots and lines. The first three patterns are shown below.

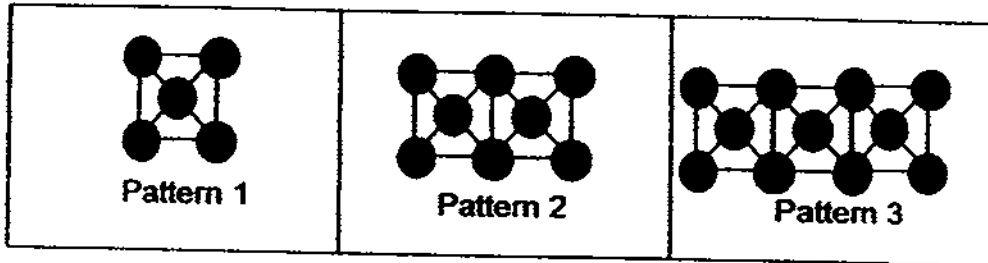

Pattern	1	2	3	
Number of squares	1	2	3	20
Number of dots	5	8	11	98
Number of lines	8	15	22	?

- (a) How many dots are there in Pattern 98?
 (b) How many more lines than dots are there in a pattern of 98 squares?

Ans: (a) _____ (1m)

(b) _____ (3m)

Do not write
in this space

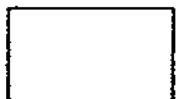

Do not write in this space

15. The figure shows 3 squares, A, B and C. 25 % of Square C is shaded. The ratio of the area of Square A to the area of Square B is 9 : 8. The ratio of the area of Square B to the area of Square C is 4 : 1.

(a) What is the ratio of the area of Square A to the area of Square B to the area of Square C? Leave your answer in the simplest form.

(b) What fraction of the total area of the figure is the unshaded area of Square B? Leave your answer in the simplest form.

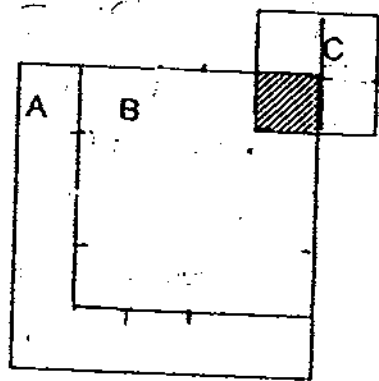

Ans: (a) _____ (2)

(b) _____ (3)

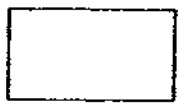

16. Mr Tan purchased a total number of 300 hotdog buns and custard buns. Each bun cost \$ 1.20. He sold each custard bun at \$ 2.20, and each hotdog bun at \$ 1.80. He gave the remaining 8 buns to his wife. Then he counted his money and found that he had earned \$ 240 in total. Find the number of the hotdog buns and the number of custard buns sold by Mr Tan.

After deducting the amount he paid for buying all the buns, he

Do not write in this space

Ans: Custard Buns: _____

Hotdog Buns: _____ [5]

17. The pattern below shows part of a tessellation.

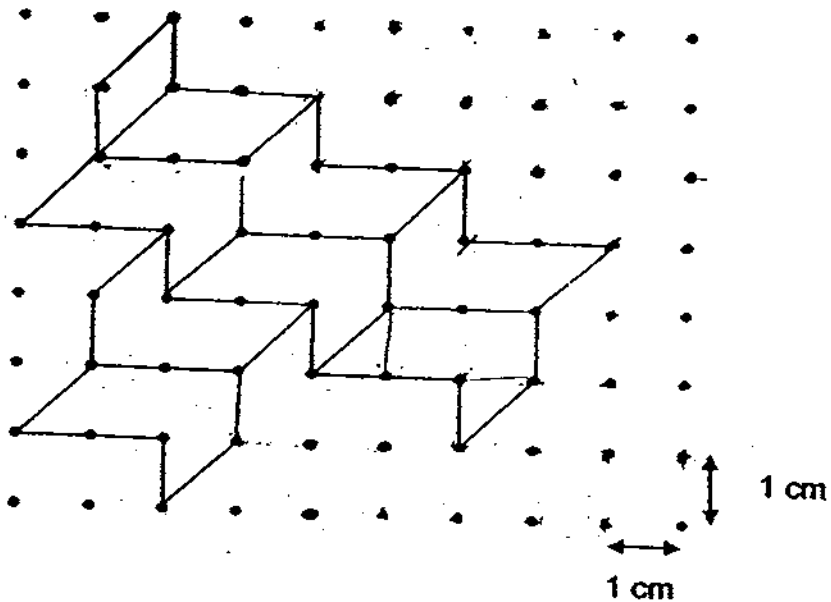

(a) Colour a unit shape of the tessellation in blue. (1m)

(b) Find the area of the unit shape. (2m)

(c) Extend the tessellation by drawing six more unit shapes in the space provided above. (2m)

Do not write in this space

Ans: (b) _____

18. Alex had some coins in his piggy bank.

There were 80 coins altogether.

There were only 20-cent coins and 50-cent coins in his piggy bank.

After using 50 % of the 20-cent coins and 25 % of the 50-cent coins to buy a storybook, he still had 46 coins left.

(a) What percentage of the coins in the box were 50-cent coins at first?

(b) How much did the storybook cost?

Do not
write in
space

Ans: (a) _____ (3m)

(b) _____ (2m)

End of Paper





ANSWER SHEET

EXAM PAPER 2009

**SCHOOL : NAN HUA PRIMARY
SUBJECT : PRIMARY 5 MATHEMATICS**

TERM : SA2



Q1	Q2	Q3	Q4	Q5	Q6	Q7	Q8	Q9	Q10	Q11	Q12	Q13	Q14	Q15
2	3	2	2	1	2	1	4	3	2	3	1	1	2	2

- 16) 17.7 17) 1,3,5,15 18) 9 stars 19) $1/6$ 20) 5:12
21) \$321 22) 8cm 23) 2.8cm 24) $7\frac{3}{7}$ 25) 192 points
26) 11.105 27) $\frac{1}{4}$ 28) 30° 29) 16 roses 30) 18 marbles

Paper 2

1) $15 \times 3 \times 10 = 4500$ $4500 \div 450 = 10$ min	2) $100\% - 20\% = 80\%$ $80\% \rightarrow 180$ min $1\% \rightarrow 180 \div 80 = 2.25$ $100\% \rightarrow 2.25 \times 100 = 225$ mm
3) 50	4) $70 + 63 = 139$ $300 - 139 = 161$ $161 - 82 = 79$ $82 - 79 = 3$ marks
5) $2 \times 2 = 4$ $4 \times 2 = 8$ cm ²	6) $5 \times 50 \times 60 = 15000$ $25 \times 1000 = 25000$ $25000 - 15000 = 10000$ $10000 \div 1000 = 10$ L There is 10L left
7) $180 - 108 = 72$ $180 - 140 = 40$ $108 + 40 = 148$ $180 - 148 = 32$ $72 - 32 = 40^\circ$ It is 40°	8) $8/21$ of the members

9) $8 \times 8 = 64$
 $11 - 8 = 3$
 $11.50 \times 3 = 34.50$
 $34.50 + 64 = \$98.50$
 He earns \$98.50

10) $12 - 2 = 10$
 $10 \div 2 = 5$
 $5 + 2 = 7$
 $7 \times 3 = 21$
 $93 - 21 = 72$
 $72 \div 12 = \$6$
 She paid \$6 for a magazine

11) \$0.20

12) 39cm

13) $20 - 12 = 8$
 $8 \times 5 = 40$
 $40 + 12 = 52$
 $52 \div 4 = 13$
 $13 \times 3 = 39$
 He had 39 more balls.

14) a) $5 + (3 \times 97) = 296$
 There are 296 dots.
 b) $8 + (97 \times 7) = 687$
 $687 - 296 = 391$
 There are 391 more lines.

15) a) 9:8:2
 b) 5/7

16) Custard Buns: 186
 Hotdog Buns: 106

17) a) c)

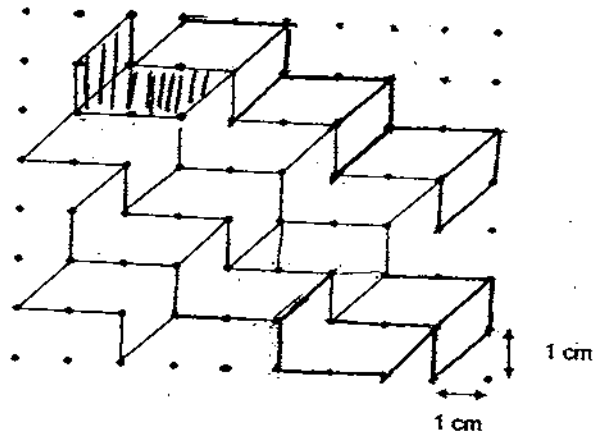

b) 3 cm^2

18) a) 30%
 b) \$8.60