



**RAFFLES GIRLS' PRIMARY SCHOOL
SEMESTRAL ASSESSMENT 2
MATHEMATICS (PAPER 1)
PRIMARY 5**

Name: _____ ()

Form Class: P5 _____

Math Teacher: _____

Date: 27 Oct 2014

Duration: 50 min

Your Paper 1 Score (Out of 40 marks)	
Your Paper 2 Score (Out of 60 marks)	
Your Total Score (Out of 100 marks)	
Parent's Signature	

INSTRUCTIONS TO CANDIDATES

1. Do not turn over this page until you are told to do so.
2. Follow all instructions carefully.
3. Answer **ALL** questions and show all working clearly.
4. **NO** calculator is allowed for this paper.

Questions 1 to 10 carry 1 mark each. Question 11 to 15 carry 2 marks each.
For each question, four options are given. One of them is the correct answer.
Make your choice (1, 2, 3 or 4). Shade your answer (1, 2, 3 or 4) on the OAS
provided. All diagrams are not drawn to scale.

1. Round off 349.016 to the nearest hundredths.

- (1) 300
- (2) 349.01
- (3) 349.02
- (4) 400

2. How many ninths are there in $2\frac{5}{9}$?

- (1) 16
- (2) 18
- (3) 23
- (4) 28

3. Triangle ABC is an equilateral triangle. Find its perimeter.

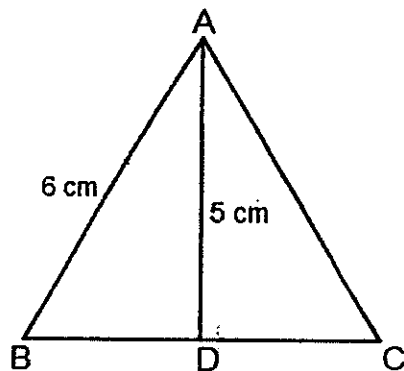

- (1) 11 cm
- (2) 15 cm
- (3) 18 cm
- (4) 23 cm

4. In the square grid below, Point C is _____ of Point E.

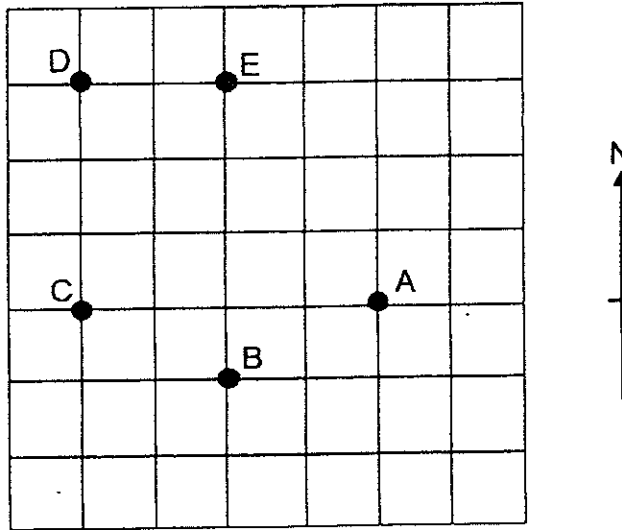

- (1) NE
- (2) NW
- (3) SE
- (4) SW

5. Which one of the shapes below cannot be tessellated?



6. The number of visitors to a museum in a year was 550 000 when rounded off to the nearest ten thousands. What was the largest possible number of people visitors to the museum?
- (1) 544 999
 - (2) 545 999
 - (3) 554 999
 - (4) 555 999
7. The usual price of an oven was \$450. During a sale, Suzanne paid \$360 for it. What was the percentage discount given?
- (1) 20%
 - (2) 25%
 - (3) 75%
 - (4) 80%
8. Express $3\frac{1}{8}$ as a decimal.
- (1) 3.1
 - (2) 3.12
 - (3) 3.125
 - (4) 3.18
9. In a class of 36 pupils, 28 pupils were swimmers. Find the ratio of the number of pupils who were swimmers to those who were non-swimmers.
- (1) 2 : 7
 - (2) 2 : 9
 - (3) 7 : 2
 - (4) 7 : 9

10. Raj sat for four tests. The average mark of the first three tests is 14. He scored 18 for his fourth test. Find his total marks for the four tests.

- (1) 15
- (2) 32
- (3) 56
- (4) 60

11. What is the least number of squares that must be shaded so that MN is the line of symmetry in the figure?

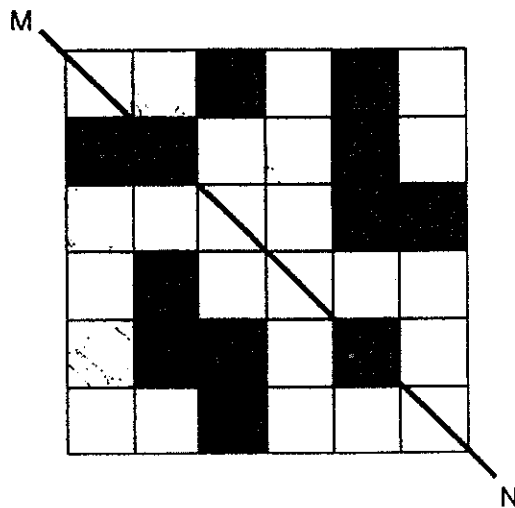

- (1) 1
- (2) 2
- (3) 3
- (4) 4

12. During a PE lesson, the ratio of the number of pupils who played basketball to the number of pupils who played netball was 3 : 2. The ratio of the number of pupils who played netball to the number of pupils who played soccer was 12 : 7. Find the ratio of the number of pupils who played basketball to the number of pupils who played soccer.

- (1) 5 : 7
- (2) 15 : 7
- (3) 3 : 7
- (4) 18 : 7

13. The figure below is made up of two squares of different sizes. Find the area of the shaded part.

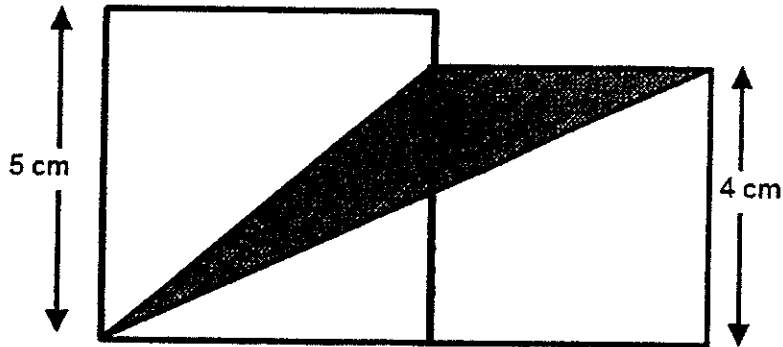

- (1) 8 cm^2
(2) 2 cm^2
(3) 10 cm^2
(4) 18 cm^2
14. Mrs Yeo received a gift basket containing apples and pears. $\frac{5}{8}$ of the fruits were apples. $\frac{1}{3}$ of the apples were red and the rest were green. There were 90 green apples. How many fruits were there in the basket?
- (1) 135
(2) 216
(3) 360
(4) 432
15. Which of the following is not a common factor of 54 and 72?
- (1) 9
(2) 6
(3) 3
(4) 4

Questions 16 to 25 carry 1 mark each.
Write your answers in the spaces provided.
For questions which require units, give your answers in the units stated.
All diagrams are not drawn to scale.
Answers in fractions or ratio must be expressed in the simplest form.

16. Arrange the following from the smallest to the largest.

$$1\frac{2}{3}, 1.78, \frac{7}{4}, 1.6$$

Ans: _____, _____, _____, _____

17. Find the value of 40×0.965 .

Ans: _____

18. In the diagram below, container A, B, C and D have different masses.
Arrange them from the lightest to the heaviest.

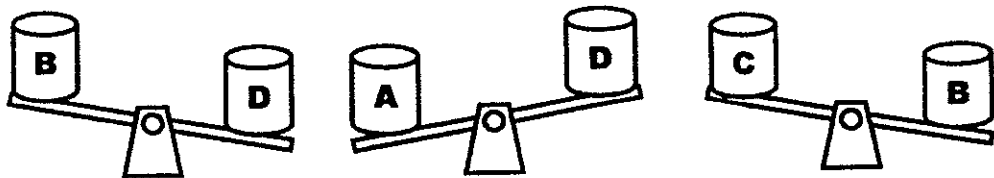

Ans: _____

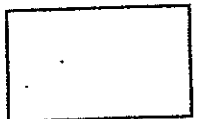

19. $\frac{3}{5}$ kg of grapes were shared equally among Jason and his 5 cousins. What was the mass of grapes received by each of them? Express your answer as a fraction in its simplest form.

Ans: _____ kg

20. The bar graph below shows the number of chicken wings sold in the canteen over five days.

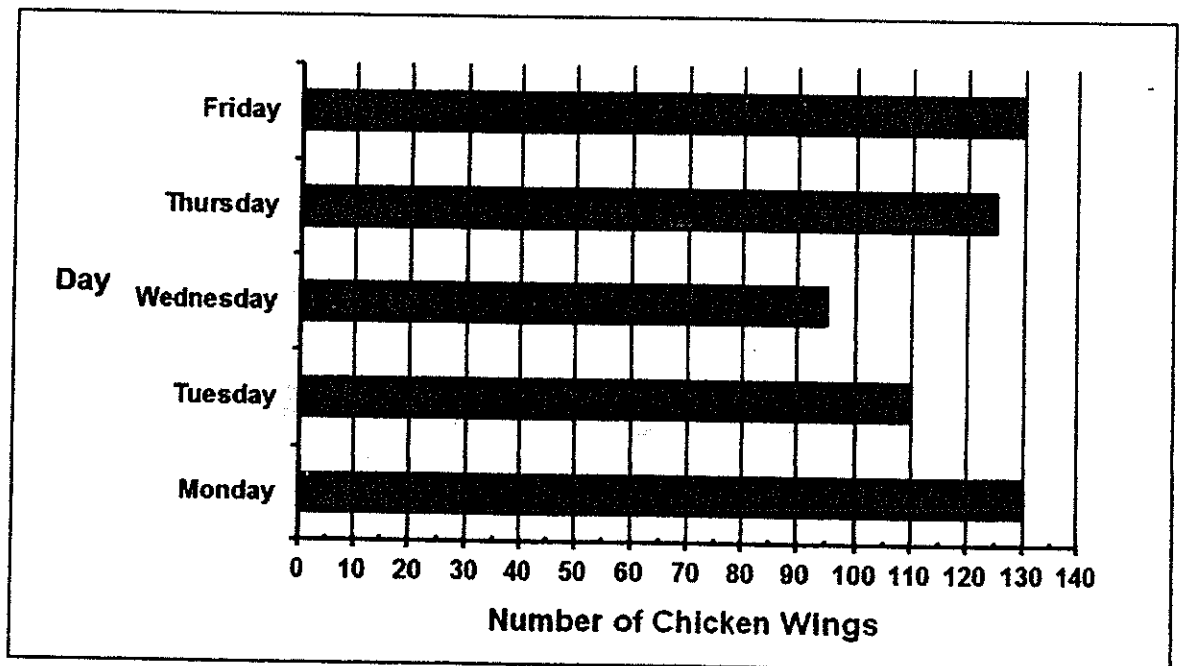

What was the total number of chicken wings sold from Tuesday to Thursday?

Ans: _____



21. The total number of seashells 3 girls collected is 138. Find the average number of seashells each girl collected.

Ans: _____

22. In the figure below, find the $\angle ABC$.

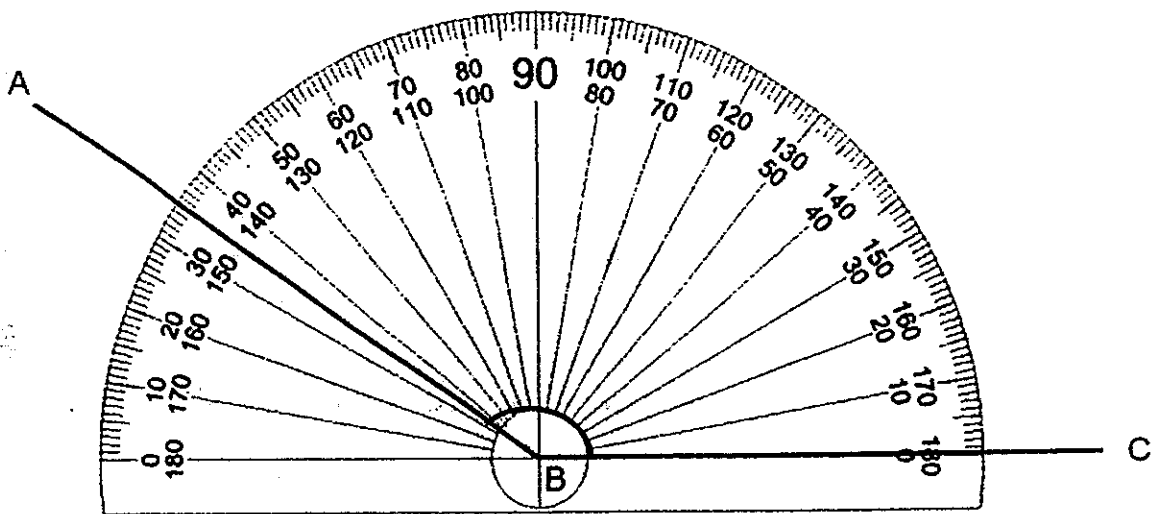

Ans: _____°



23. The figure below is not drawn to scale. ABC is an equilateral triangle. DBC is an isosceles triangle and $\angle BDC = 100^\circ$. Find $\angle ABD$.

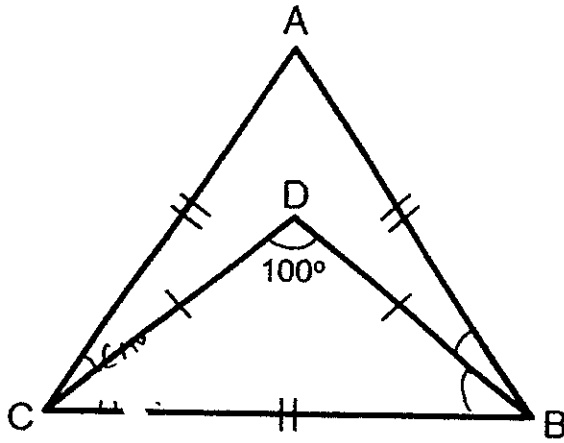

Ans: _____^o

24. The pattern in the box below shows part of a tessellation. Extend the tessellation by drawing two more unit shapes in the space provided within the box.

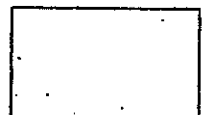
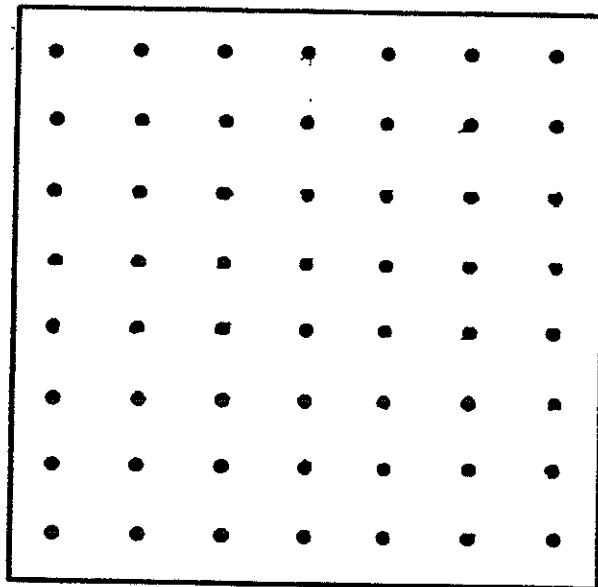

25. There were 600 people at a funfair. 120 of them were adults.
What percentage of the people at the funfair were children?

Ans: _____ %



Questions 26 to 30 carry 2 marks each.

Show your working clearly in the space provided for each question and write your answers in the space provided.

For questions which require units, give your answers in the units stated.

All diagrams are not drawn to scale.

Answers in fractions or ratio must be expressed in the simplest form.

26. Gabrielle drinks 7 bottles of mineral water each day. Each bottle contains 330 ml of water. What is the total volume of water that Gabrielle drinks each day? Express your answer in litres.

Ans: _____ l

27. Mrs Lee bought 9 kg of flour. She used $\frac{11}{12}$ of it to prepare pancakes and packed the rest equally into 3 packets. What was the mass of each packet of flour? Express your answer as a decimal.

Ans: _____ kg

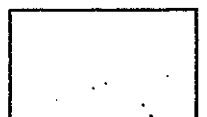

30. The bar graph below shows the number of children in each family living in a particular block of HDB flats.

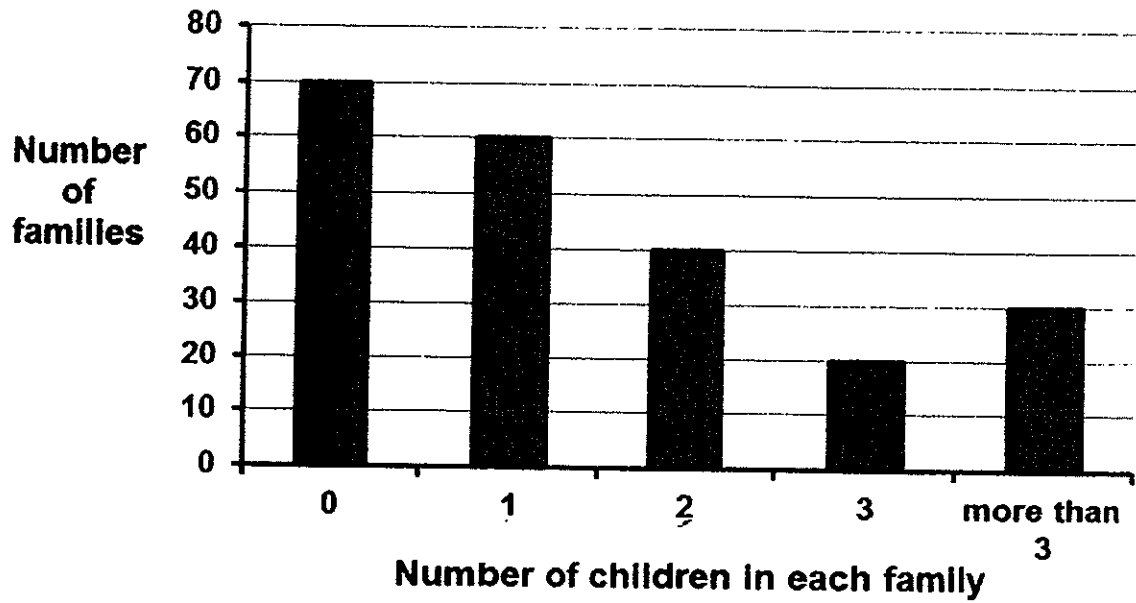

Find the total number of children in all the families that have 2 or less children.

Ans: _____

End of Paper

☺ Please check your work carefully ☺

Setters : Mr Ho K. H.
Mrs E. Tang
Mrs J. Seto





**RAFFLES GIRLS' PRIMARY SCHOOL
SEMESTRAL ASSESSMENT 2
MATHEMATICS (PAPER 2)
PRIMARY 5**

Name: _____ ()

Form class: P5 _____

Math Teacher: _____

Date: 27 Oct 2014

Duration: 1 h 40 min

Your Paper 2 Score (Out of 60 marks)	
---	--

INSTRUCTIONS TO CANDIDATES

1. Do not turn over this page until you are told to do so.
2. Follow all instructions carefully.
3. Answer **ALL** questions and show all working clearly.
4. The use of calculator is allowed for this paper.

Questions 1 to 5 carry 2 marks each. Show your working clearly in the space provided for each question and write your answers in the spaces provided. Figures are not drawn to scale. For questions which require units, give your answers in the units stated. (10 marks)

1. The figure below is not drawn to scale. AB and CD are straight lines. Find $\angle BED$.

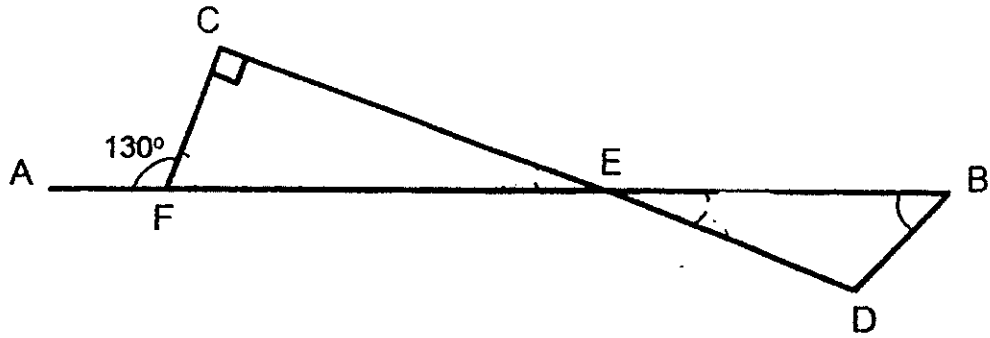

Ans: _____ ° [2]

2. In the figure below, ABCD is a rhombus with $\angle BAD = 68^\circ$. BE and CF are parallel lines with $\angle BCF = 55^\circ$. Find $\angle ABE$.

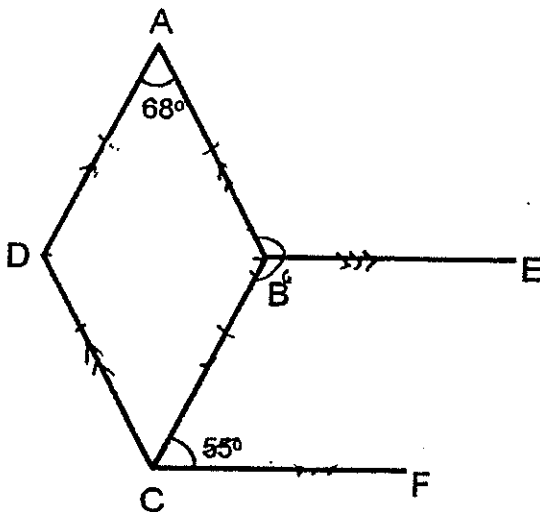

Ans: _____ ° [2]

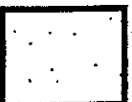

3. A group of 40 girls had to fold paper cranes for fund raising. When two of them fell ill and did not turn up, the rest of the girls had to fold 6 more paper cranes each. How many paper cranes did the girls have to fold altogether?

Ans: _____ [2]

4. In the figure below, PQ and QR are two sides of a parallelogram. Draw two lines PS and SR to complete the parallelogram.

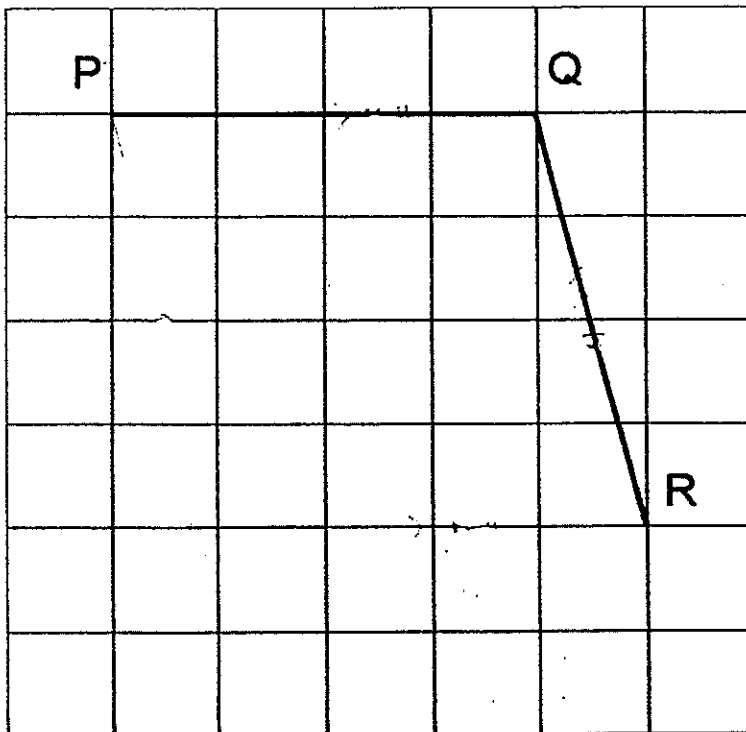

5. The figure below is made up of 12 identical rectangles.
Find the area of 1 rectangle.

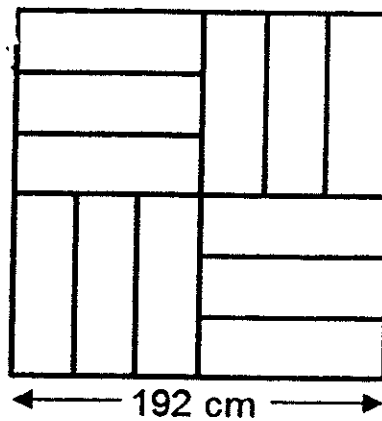

Ans: _____ cm² [2]



For questions 6 to 18, show your working clearly in the space provided for each question and write your answers in the spaces provided.
 Figures are not drawn to scale.
 The number of marks available is shown in the brackets [] at the end of each question or part-question. (50 marks)

6. At a bookshop, Natalie paid \$21.85 for a story book and 8 pens. Shirley paid \$33.05 for a similar story book and 15 similar pens. How much would 5 pens cost?

Ans : _____ [3]

7. In the figure below, ABCD is a square and CDF is an isosceles triangle with $DC = CF$. Given that $\angle ECF = 60^\circ$. Find $\angle BEF$.

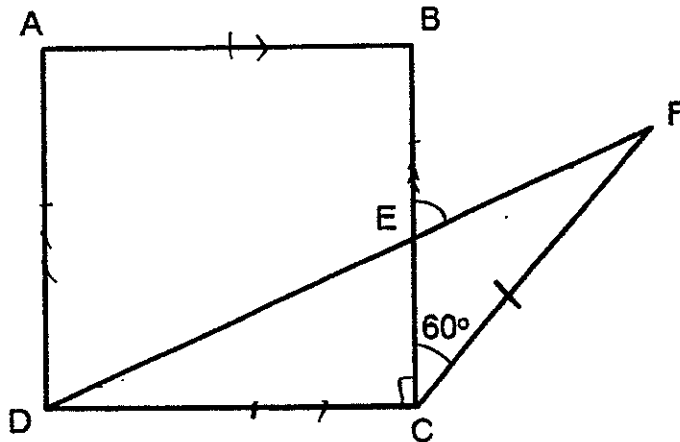

Ans: _____ [3]



8. Sammie and her five friends have a total of 251 dolls. She has 7 dolls less than the average number of dolls the rest of her friends have. How many dolls does Sammie have?

Ans: _____ [3]

9. Sean kept all his coins in a jar. On the first day, he took out half of the coins from the jar but put back 8 coins at the end of the day. On the second day, he took out half of the remaining coins from the jar but put back 8 coins at the end of that day. On the third day, Sean took out half of the remaining coins from the jar and spent all of them. In the end, Sean realised that he only had 26 coins left in the jar. How many coins did Sean have in the jar at first?

Ans: _____ [4]

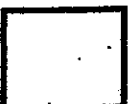

10. Heather bought a jigsaw puzzle. Over the first weekend, she fixed 38% of the puzzle. During the second weekend, Heather fixed another 792 pieces. By then, only 18% of the puzzle was not fixed.
- (a) What percentage of the puzzle was fixed during the second weekend?
 - (b) What was the total number of pieces in the jigsaw puzzle?

Ans : (a) _____ [1]

(b) _____ [3]



11. Sam was saving money to buy a watch which cost \$160. In week 1, he saved \$6. In week 2, he saved \$4 more than he did in week 1. In week 3, he saved \$4 more than he did in week 2. In which week would he have saved a total of \$160?

Ans: _____ [3]

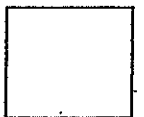

12. Container A was $\frac{1}{3}$ filled with orange juice. Then, Mr Tan added 23.4 ℓ of orange juice into it. How much more orange juice would he need to fill up Container A to its brims?

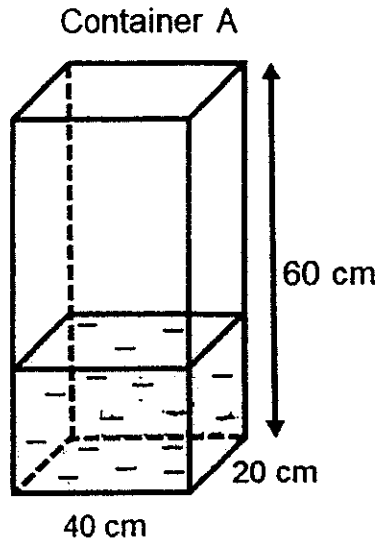

Ans: _____ [4]



13. Mr Raju bought a television set from Comet Megastore and enjoyed a 15% discount. He paid a total amount of \$2819.45 including 7% GST.
- (a) What was the price of the television set before GST?
 - (b) What was the original price of the television set?

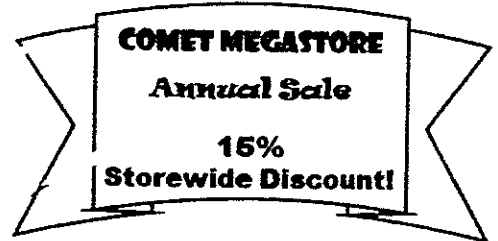

Ans: (a) _____ [2]

(b) _____ [2]



14. Marie had the same number of red, green and blue beads at first. After using some red and green beads and 1108 blue beads to make necklaces, Marie had 4250 beads left. There were twice as many red beads as green beads left. The number of blue beads left was 680 fewer than the number of red beads left. How many blue beads ~~had she left?~~
did she have at first

Ans: _____ [4]



15. Lee May bought 48 postage stamps. Each stamp cost either 50 cents or 65 cents. She paid \$27 in total. How many 50-cent stamps did she buy?

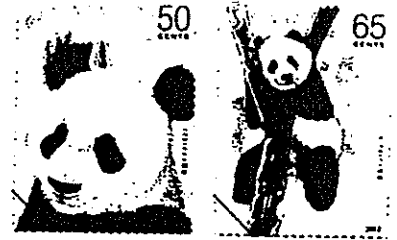

Ans: _____ [4]



16. The table below shows the parking charges at Galaxy Mall:

1 st hour or part thereof	\$2.80
Subsequent half an hour or part thereof	\$1.00
After 6 p.m.	\$3.50

- (a) Michelle arrived at Galaxy Mall at 11.45 a.m. and left at 1.30 p.m. How much did she have to pay for parking fees?
- (b) Mr Koh and his family went to Galaxy Mall to watch a movie. They left the mall at 8.30 p.m. after dinner. If Mr Koh paid \$11.30 for his parking fees, what was the earliest time they could have arrived at the mall?

Ans: (a) _____ [2]

(b) _____ [3]



17. There were 378 chairs in the school hall. The number of white chairs to the number of grey chairs was 1 : 5.
- (a) Find the number of grey chairs.
- (b) The teacher increased the number of white chairs so that the ratio of the number of white chairs to the number of grey chairs became 3 : 7.
How many white chairs were added?

Ans: (a) _____ [2]

(b) _____ [3]



18. Mr Jones had some cows and some horses on his ranch. He sold $\frac{2}{5}$ of the cows and $\frac{1}{6}$ of the horses. A total of 570 cows were sold. In the end, Mr Jones had the same number of cows and horses left.

- a) Find the total number of cows and horses on the ranch at first.
- b) Express the number of horses at first as a fraction of the number of cows at first. Give your answer in the simplest form.

Ans: (a) _____ [3]

(b) _____ [1]

End of Paper
Please check your work carefully ☺



Setters: Mr. Ho K. H.
Mrs E. Tang
Mrs J. Seto





Paper 2

Q1 $\angle a = 180^\circ - 130^\circ = 50^\circ$
 $\angle BED = 180^\circ - 90^\circ - 50^\circ$
 $= 40^\circ$

Q2 $\angle a = 180^\circ - 56^\circ = 124^\circ$
 $\angle b = 180^\circ - 68^\circ = 112^\circ$
 $\angle BED = 360^\circ - 112^\circ - 124^\circ$
 $= 124^\circ$

Q3 $40 - 2 = 38$
 $38 \times 6 = 228$
 $228 \div 2 = 114$
 $114 \times 40 = 4560$

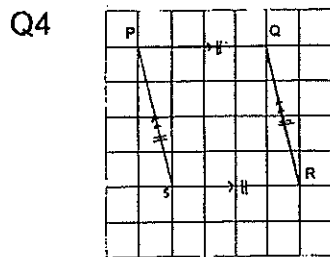

Q5 $192\text{cm} \times 192\text{cm} = 36864\text{cm}^2$
 $36864\text{cm}^2 \div 12 = 3072\text{cm}^2$

Q6 $S + 8P = 21.85$
 $S + 15P = 33.05$
 $7P \rightarrow 33.05 - 21.85 = 11.2$
 $P \rightarrow 11.2 \div 7 = 1.6$
 $1.6 \times 5 = 8$

Q7 $\angle a = (180^\circ - 60^\circ - 90^\circ) \div 2$
 $= 15^\circ$
 $\angle b = 180^\circ - 60^\circ - 15^\circ$
 $= 105^\circ$
 $\angle BEF = 180^\circ - 105^\circ$
 $= 75^\circ$

Q8 $7 \times 5 = 35$
 $251 - 35 = 216$
 $216 \div 6 = 36$

Q9 $26 \times 2 = 52$
 $52 - 8 = 44$
 $44 + 44 = 88$
 $88 - 8 = 80$
 $80 \times 2 = 160$



Q10 (a) $38\% + 18\% = 56\%$
 $100\% - 56\% = 44\%$

(b) $\frac{792}{44} \times 100 = 1800$

Q11

Week	1	2	3	4	5	6	7	8	9
\$	6	10	14	18	22	26	30	34	38

\$160

$6 + 10 + 14 + 18 + 22 + 26 + 30 + 34 = 160$

Q12 $40 \times 20 \times 60 = 48000$
 $48000 \times \frac{1}{3} = 16000$
 $16000 \text{ cm}^3 = 16 \text{ l}$
 $16 + 23.4 = 39.4$
 $48000 \text{ cm}^3 = 48 \text{ l}$
 $48 - 39.4 = 8.6$

Q13 $107\% \rightarrow \$2819.45$
 $100\% \rightarrow \$2635$
 $100\% - 15\% = 85\%$
 $85\% \rightarrow \$2635$
 $100\% \rightarrow \$3100$

Q14

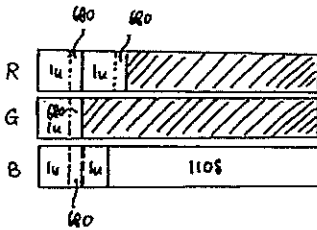

$680 \times 4 = 2720$
 $4250 - 2720 = 1530$
 $54 \div 1530$
 $14 \Rightarrow 1530 \div 5 = 306$
 $306 \times 2 = 612$
 $612 + 680 = 1292$
 $1108 + 1292 = 2400$

Q15 Assume all are 65 stamps

$0.65 \times 48 = 31.2$
 $31.2 - 27 = 4.2$
 $0.65 - 0.5 = 0.15$
 $4.2 \div 0.15 = 28$

Q16

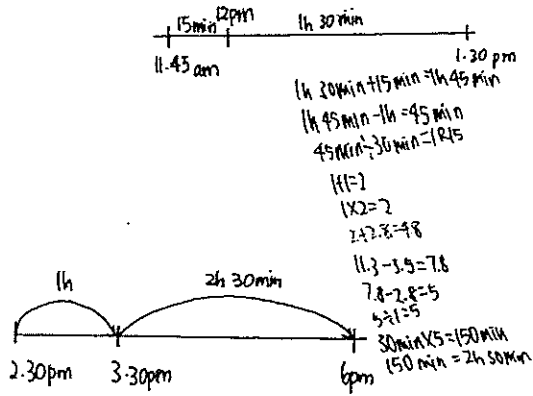

Q17

$W:G:T$
 $1:5:6$
 (378)
 $\frac{5}{6} \times 378 = 315$

$W:G$
 $1:5 \times 7$
 $7:35$

$K:T$
 $3:7 \times 5$
 $15:35$

$35 + 7 = 42$
 $42 \rightarrow 378$
 $16 \rightarrow 378 \div 42 = 9$
 $15 - 7 = 8$
 $9 \times 8 = 72$

Q18

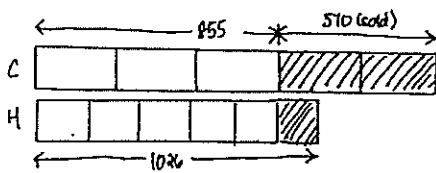

$2u > 570$
 $1u > 570 \div 2 = 285$
 $285 \times 3 = 855$
 $5p > 855$
 $1p > 855 \div 5 = 171$
 $H \rightarrow 171 \times 6 = 1026$
 $C \rightarrow 285 \times 5 = 1425$
 $1425 + 1026 = 2451$
 $\frac{1026}{1425} = \frac{18}{25}$

