

# Anglo-Chinese School (Junior)



## BITE-SIZED ASSESSMENT 3 (2021)

PRIMARY 5

SCIENCE

Tuesday

24 August 2021

50 min

Name: \_\_\_\_\_ ( ) Class: 5.( ) Parent's Signature: \_\_\_\_\_

### INSTRUCTIONS TO PUPILS

- 1 Do not turn over the pages until you are told to do so.
- 2 Follow all instructions carefully.
- 3 There are 13 questions in this booklet.
- 4 Answer ALL questions.
- 5 The marks are given in the brackets [ ] at the end of each question or part question.

Question Paper	Possible Marks	Marks Obtained
<b>Total</b>	<b>30</b>	

---

This question paper consists of 14 printed pages (inclusive of cover page).

1. The diagram shows the female reproductive system of a human.

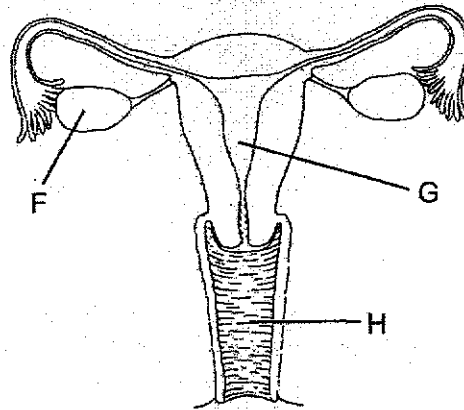

(a) Name and state the function of part F. [1]

---

(b) Which part of the reproductive system, F, G or H, does a baby develop in? Name the part. [1]

---

(c) The female fish releases a large number of eggs at a time from its body into the water. The picture shows a female fish releasing eggs and a male fish releasing sperms over the eggs at the same time to fertilise the eggs.

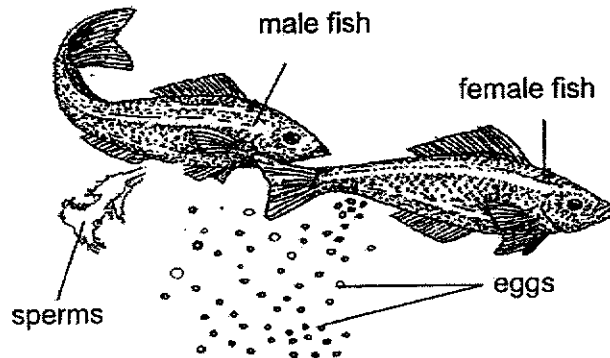

Based on the picture, explain why the female fish releases a large number of eggs at a time to ensure the continuity of its species. [1]

---



---

(Go on to the next page)

SCORE	3
-------	---

2. The diagrams show the human and the plant reproductive systems.

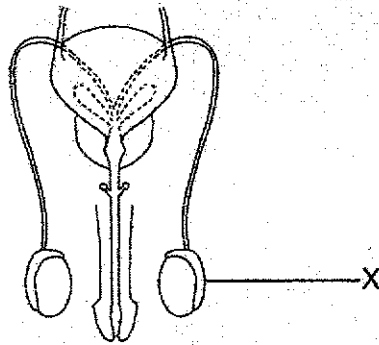

Human reproductive system

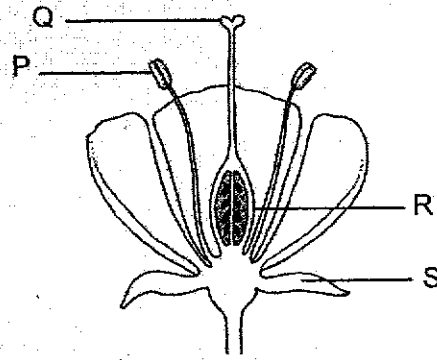

Plant reproductive system

(a) Which part of the plant reproductive system, P, Q, R or S, has a similar function as part X of the human reproductive system? State its function. [1]

---

---

(b) Name part R and state its function. [1]

---

---

(Go on to the next page)

SCORE	<hr/>
	2

3. Mr Tan had a lot of plants in his garden. He noticed bees flying around the flowers growing in his garden.

(a) How could bees be helpful to flowers pollinated by animals?

[1]

---

---

Mr Tan plucked two flowers, A and B from his garden. The diagrams show the cross-sections of flowers, A and B.

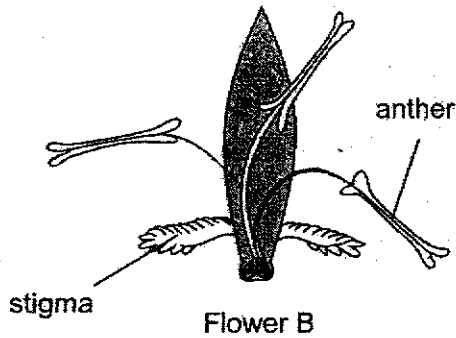
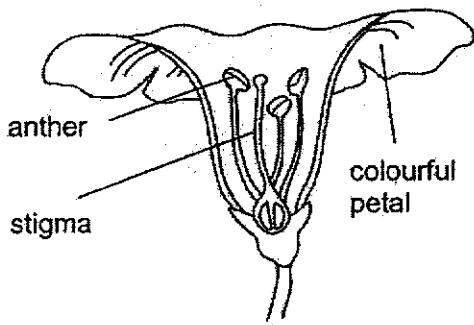

(b) The anthers of flower B are long and stick out of the flower and its stigma is feathery and exposed. Explain how this helps in pollination.

[2]

---

---

---

(Go on to the next page)

SCORE	3
-------	---

4. Fertilisation in flowering plants and humans can be prevented by certain methods.

A cut at part X of the plant reproductive system, as shown, prevents fertilisation from taking place.

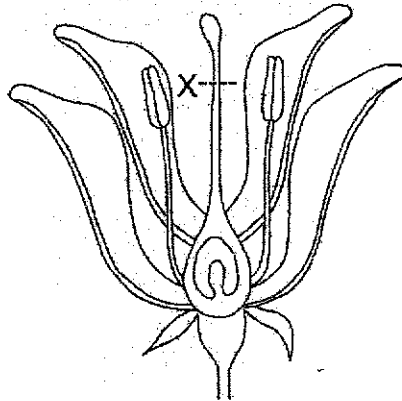

Plant reproductive system

Unlike the plant reproductive system, the human reproductive system needs cuts at two parts, Y and Z, as shown to prevent fertilisation from taking place.

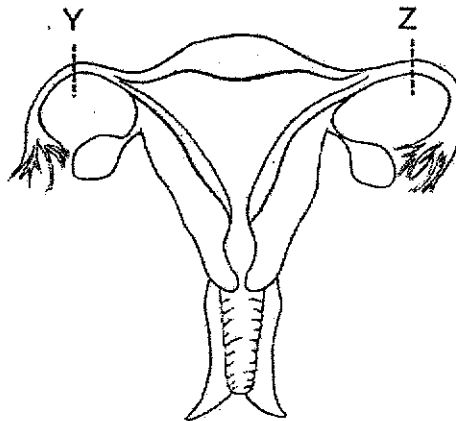

Human reproductive system

Give a reason why only one cut is required in the plant reproductive system but two cuts are required in the human reproductive system to prevent fertilisation. [1]

---



---

(Go on to the next page)

SCORE	1
-------	---

5. James had some plants in his garden. One of the plants produced bright coloured flowers. When the flowers of this plant bloomed, he removed the petals of some of the flowers. A cross-section of this flower is shown.

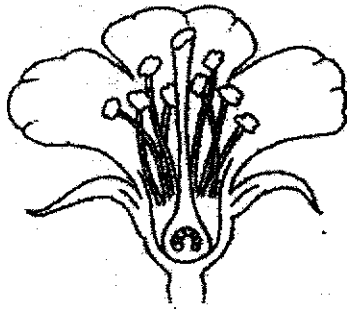

cross-section of flower with petals

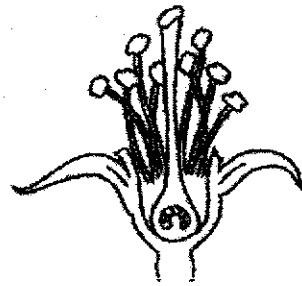

cross-section of flower without petals

- (a) He noticed that the number of fruits produced by flowers without petals had decreased. Explain why. [2]

---



---



---

- (b) James' brother obtained three identical flowers, L, M and N from the garden. He removed different parts from each of the flowers as shown.

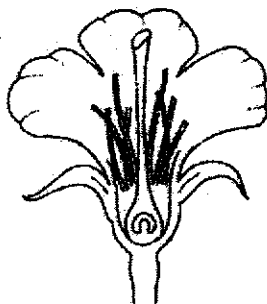

Flower L

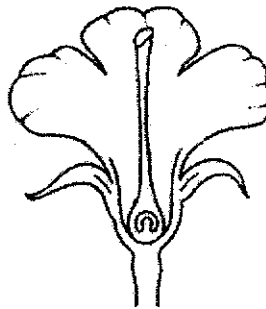

Flower M

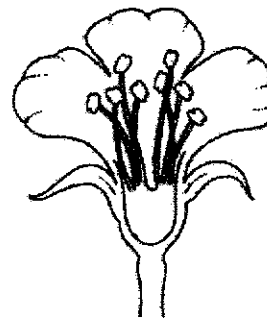

Flower N

- Which of the above flower(s), L, M and/or N, can still develop into a fruit after pollen is dusted across all the flowers? Give a reason for your answer. [1]

---



---

(Go on to the next page)

SCORE	3
-------	---

6. At the beginning, only island A had plants Y and Z.

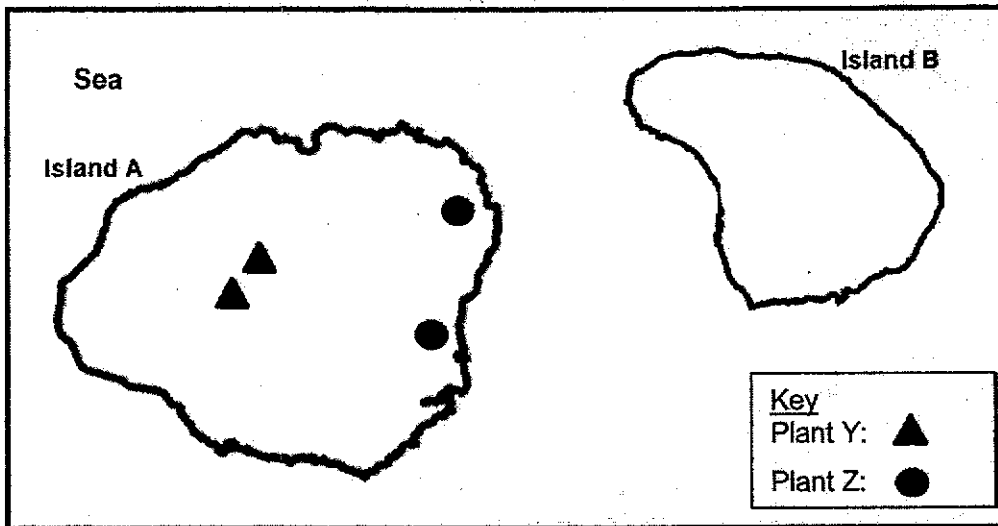

A few years later, island B started to have plant Z as shown.

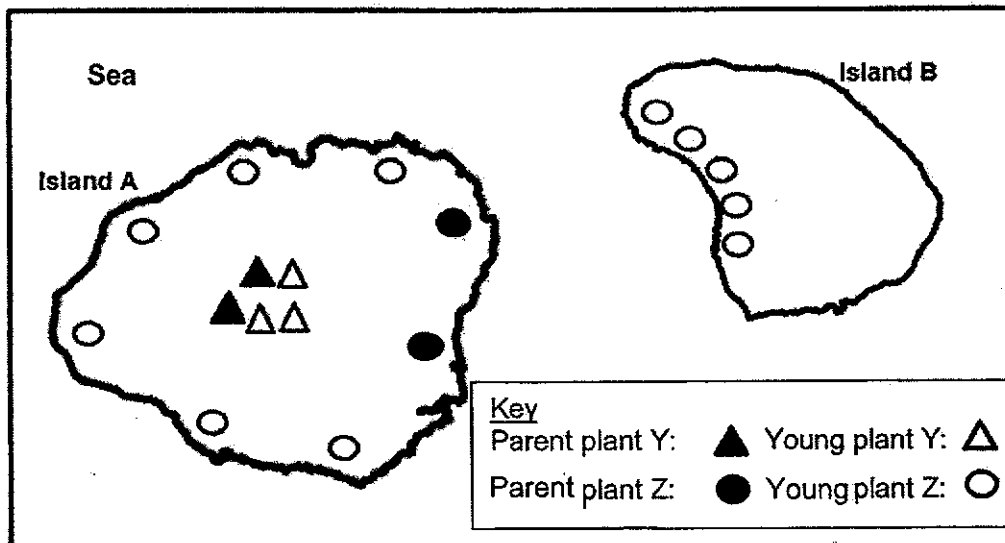

(a) Based on your observation of the dispersal pattern, identify the dispersal method for each of the fruits/seeds of plant Y and plant Z. [1]

Y: \_\_\_\_\_

Z: \_\_\_\_\_

(b) State an advantage of the method used by plant Y to disperse its fruits/seeds. [1]

\_\_\_\_\_

\_\_\_\_\_

(Go on to the next page)

SCORE	2
-------	---

7. Bala conducted an experiment to find out how the speed of wind affects the distance a fruit travels. He dropped the fruit from a height,  $h$ , in front of a fan as shown. He measured the distance,  $d$ , it travelled.

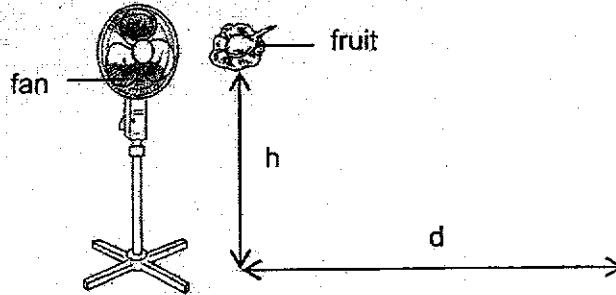

Each time the wind speed was changed, the distance,  $d$ , travelled by the fruit was measured and recorded in the table.

Wind speed	Distance, $d$ , travelled by the fruit (m)			Average (m)
	1 <sup>st</sup> attempt	2 <sup>nd</sup> attempt	3 <sup>rd</sup> attempt	
Low	1.5	1.4	1.6	1.5
Medium	3.2	3.1	3.3	3.2
High	5.6	5.5	5.4	5.5

- (a) How is the distance travelled by the fruit affected by the wind speed? [1]

---



---

- (b) Bala then wanted to find out how the size of the wing-like structure of the fruit affects the distance the fruit travelled.

Identify the variables that should be kept the same or changed to test this new aim. Place a tick (✓) in the correct boxes in the table. [1]

Variables		Keep the same	Change
(i)	Wind speed		
(ii)	Height that the fruit is dropped		
(iii)	Size of wing-like structure		
(iv)	Type of fruit		

(Go on to the next page)

SCORE	2
-------	---



8. Three different materials, A, B and C, are each connected in separate circuits as shown. Only the bulb in the circuit with material B did not light up.

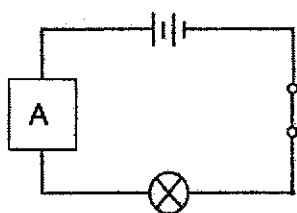

The bulb lights up.

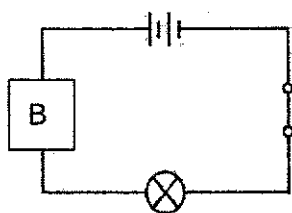

The bulb does not light up.

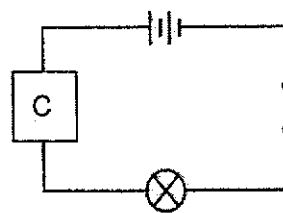

The bulb lights up.

Materials A, B and C are then connected to bulbs X and Y in another circuit as shown.

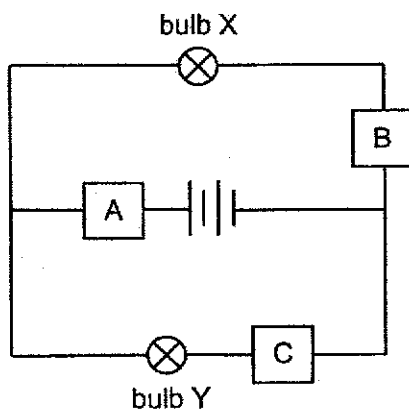

Which bulb(s), X and/or Y, will light up? Explain your answer.

[2]

---



---



---

(Go on to the next page)

SCORE	2
-------	---

9. The diagrams show a toy car and circuit A which is found in the toy car.

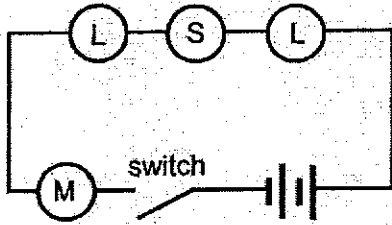
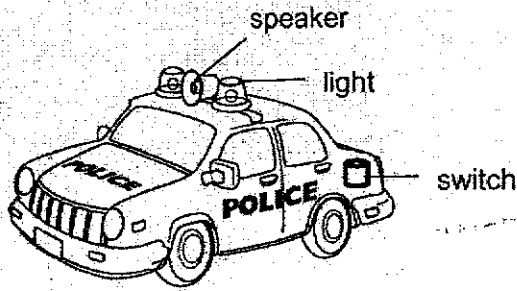

Circuit A

Key	Electrical Part
L	Light
S	Speaker
M	Motor to turn wheels

(a) Without adding or removing anything from the circuit, suggest one change to circuit A to increase the brightness of the light. [1]

---



---

(b) The same electrical parts in the toy car are connected to form circuit B as shown.

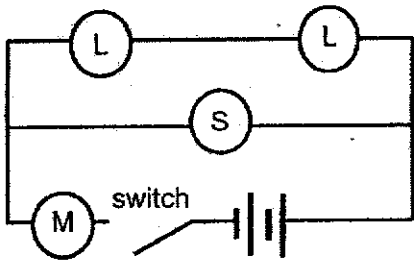

Circuit B

Key	Electrical Part
L	Light
S	Speaker
M	Motor to turn wheels

State an advantage of circuit B compared to circuit A. [1]

---



---

(Go on to the next page)

SCORE	2
-------	---

10. Tom conducted an experiment using a circuit as shown.

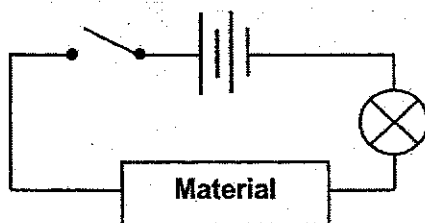

He placed different materials in the circuit and recorded his results in the table.

Material	Did the bulb light up?
A	Yes
B	Yes
C	No

(a) State the aim of Tom's experiment. [1]

---



---

Tom set up another circuit as shown, where materials, A, B and C could be placed at positions 1, 2 or 3.

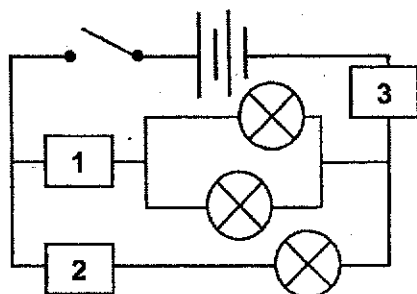

(b) Which positions should materials, A, B and C be placed so that (i) none of the bulbs light up and (ii) most number of bulbs light up?

(i) none of the bulbs light up [1]

Position	1	2	3
Material			

(ii) most number of bulbs light up [1]

Position	1	2	3
Material			

(Go on to the next page)

SCORE	3
-------	---

11. Jerry set up a circuit as shown.

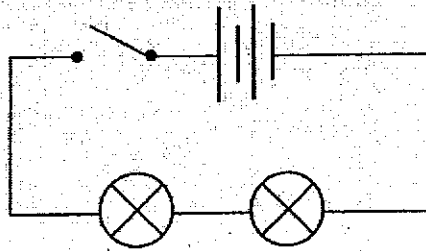

He measured the brightness of the bulbs and plotted the following graph.

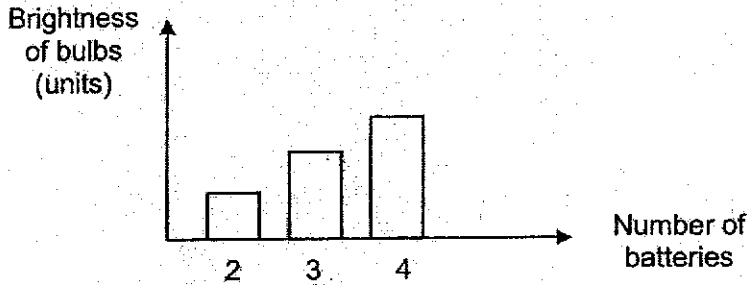

(a) State the relationship between the number of batteries and the brightness of the bulbs. [1]

---



---

Jerry added a 5<sup>th</sup> battery to the circuit and recorded his observation in the graph.

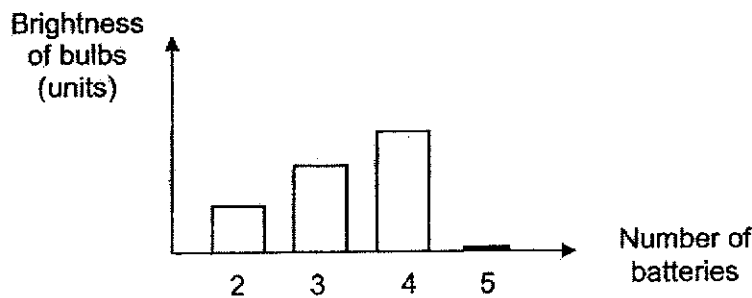

(b) Give a reason why the brightness of the bulbs changed when the 5<sup>th</sup> battery was added. [1]

---



---

(Go on to the next page)

SCORE	2
-------	---

12. Susan set up two circuits, M and N, as shown. Both bulbs in the circuits lit up when the switches were closed.

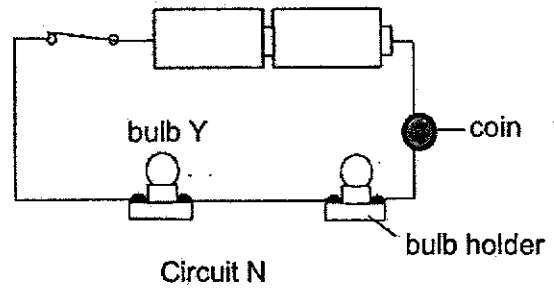
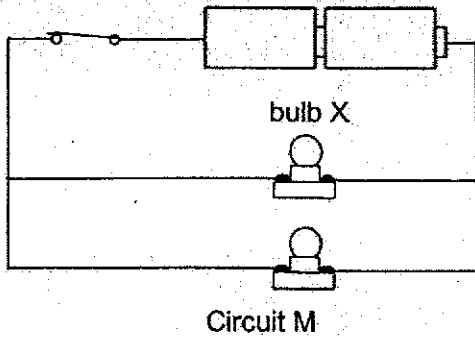

For each of the statements, indicate if the statement is 'True', 'False' or 'Not Possible to Tell' by placing a tick (✓) in the correct boxes. [2]

	Statements	True	False	Not Possible to Tell
(a)	When bulb X fuses, the other bulb in circuit M will not light up.			
(b)	Adding one more battery to circuit M will cause bulb X to be brighter.			
(c)	When bulb Y is removed from the bulb holder, the other bulb in circuit N will not light up.			
(d)	The coin in circuit N is made of copper.			

(Go on to the next page)

SCORE	2
-------	---

13. Ahmad conducted an experiment using circuit Y as shown.

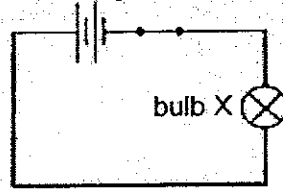

Circuit Y

He added a bulb in parallel to bulb X one at a time until there were three bulbs. All the electrical parts are working.

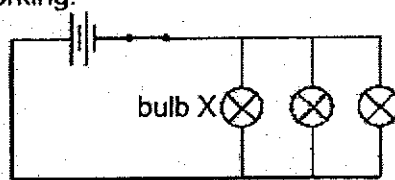

Circuit Y

(a) Complete the bar graph, using a ruler and pencil, to indicate the brightness of bulb X in circuit Y for every additional bulb added to the circuit. [1]

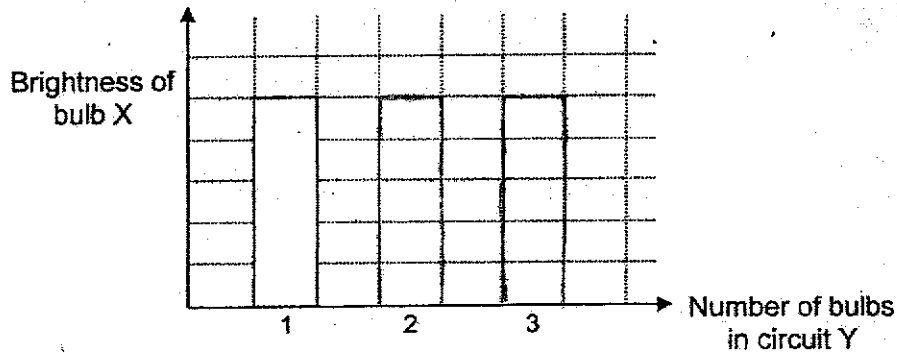

(b) Ahmad would like to set up another circuit to reduce the brightness of bulb X without adding or removing anything from circuit Y.

Draw the circuit diagram of this new circuit and label bulb X. [2]

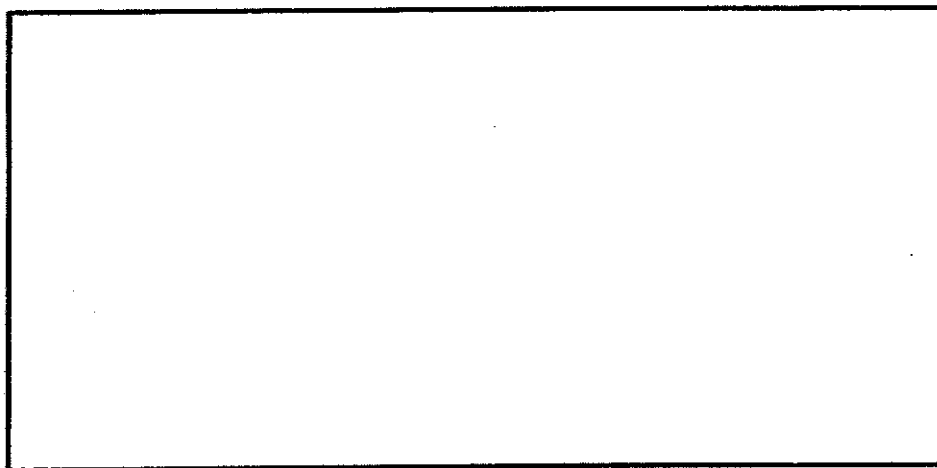

End of Paper

SCORE	3
-------	---

SCHOOL : ANGLO CHINESE PRIMARY SCHOOL  
 LEVEL : PRIMARY 5  
 SUBJECT : SCIENCE  
 TERM : 2021 WA3

Q1a)	Ovary, produce the eggs.
Q1b)	G. Womb
Q1c)	To increase the chances of eggs being fertilised which will hatch and develop into young.
Q2a)	P. It produces the male reproductive cells / pollen grains.
Q2b)	Ovary. It stores and protects the ovules.
Q3a)	The bees help in the transfer of pollen grains from the anther to the stigma of the flower.
Q3b)	The anthers stick out so that when pollen grains drop off, the wind can carry it to another flower easily. The stigma is feathery and exposed so that when pollen grains are blown there by the wind, it can receive the pollen grains easier.
Q4)	The human reproductive system needs two cuts because eggs are produced from two ovaries while if the flower only has one ovary and there is only one entrance which is at X.
Q5a)	Without petals, less insects will land on the flower, less flowers will be pollinated and fertilised to develop into fruits.
Q5b)	L and M. Their stigma and ovaries are still present so pollen grains can land on the stigma to pollinate it.
Q6a)	Y: splitting Z: water
Q6b)	Plant Y does not need other animals/wind or water to disperse its seeds.
Q7a)	As the wind speed increases, the distance travelled by the fruit increases.
Q7b)	i) Keep the same ii) Keep the same iii) Change iv) Keep the same
Q8)	Y. A and C are conductors of electricity so electricity will be able to flow through the circuit to light bulb Y up but B is not a conductor of electricity so electricity will not be able to flow through it to light up bulb X.
Q9a)	Rearrange the parts so that S and M are parallel to the light.
Q9b)	The lights will light up brighter.
Q10a)	To find out which material is a conductor of electricity.
Q10b)	i) A, B, C ii) A, C, B

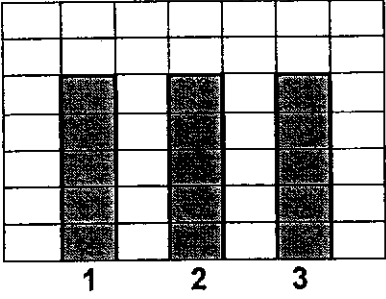
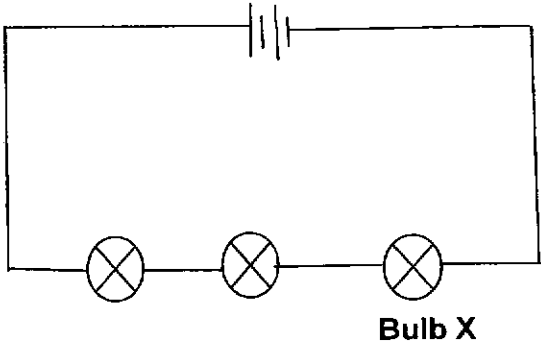
Q11a)	As the number of batteries increases, the brightness of the bulb increases.								
Q11b)	The bulbs fused.								
Q12)	a) False b) True c) True d) Not possible to tell								
Q13a)	 <p>A bar graph with a grid. The x-axis is labeled 1, 2, and 3. The y-axis has 10 horizontal grid lines. Three shaded bars are shown, each reaching the 7th grid line from the bottom.</p> <table border="1"><thead><tr><th>Category</th><th>Value</th></tr></thead><tbody><tr><td>1</td><td>7</td></tr><tr><td>2</td><td>7</td></tr><tr><td>3</td><td>7</td></tr></tbody></table>	Category	Value	1	7	2	7	3	7
Category	Value								
1	7								
2	7								
3	7								
Q13b)	 <p>A circuit diagram showing a battery at the top connected to three light bulbs in series. The rightmost bulb is labeled "Bulb X".</p>								