

NAN HUA PRIMARY SCHOOL
CONTINUAL ASSESSMENT 1, 2007
PRIMARY 5
SCIENCE

Sect A	/ 60
Sect B	/ 40
Total	/ 100

Name: _____ ()

Class: Primary 5 _____

Parent's Signature

Date: 1 March 2007

Duration: 1hr 45 min

Section A (60 marks)

For each question 1 to 30, four options are given. Make your choice (1,2,3,4) and shade the correct oval on the Optical Answer Sheet (OAS) provided.

1. The Sun is important to us because it provides _____

- A: us with heat and light
- B: living things with oxygen
- C: plants with light to make food
- D: carbon dioxide for plants to make food

- ① A and B only
- ② A and C only
- ③ B and C only
- ④ B and D only

2. Which one of the following statements about the Earth is true?

- ① It is a star.
- ② It gives out its own light.
- ③ It revolves around the Sun.
- ④ It rotates from East to West about its axis.

3. The change from day to night is caused by the

- (1) Earth facing the Sun.
- (2) Earth rotating about its own axis.
- (3) Moon revolving around the Earth.
- (4) Sun and Moon revolving around the Earth.

4. The _____ revolves around the Earth.

- (1) Moon
- (2) stars
- (3) Sun
- (4) planets

5. Plant cells have _____ but animal cells do not.

- (1) chloroplasts
- (2) cytoplasm
- (3) nucleus
- (4) cell membrane

6. The _____ controls all the activities of the cell.

- (1) brain
- (2) nucleus
- (3) cytoplasm
- (4) cell membrane

7. Which one of the following is not true?

- (1) The cell wall protects the cell.
- (2) The cell wall is absent in animal cells.
- (3) The cell wall makes food for the plant.
- (4) The cell wall gives the cell a regular shape.

8. To be able to make starch, a cell needs to have _____.
- ① cell wall
 - ② chloroplast
 - ③ cytoplasm
 - ④ cell membrane
9. Which one of the following best shows water conservation in action?
- (1) Leaving a leaky tap to drip.
 - (2) Watering plants with a hose.
 - ③ Brushing teeth using a mug of water.
 - (4) Leaving the shower on while soaping and shampooing.
10. Andrew pulled up the plunger of the syringe and drew in 10ml of air. He then covered the nozzle of the syringe with his finger and tried to push the plunger down, as shown in the diagram.

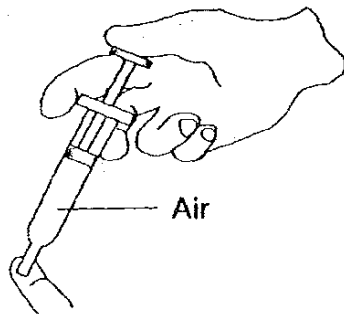

He found that he could push the plunger in, to a certain extent only. From this simple experiment, Andrew can conclude that air _____.

- ① can be compressed
- (2) has a definite shape
- (3) has a definite volume
- (4) does not have mass

2



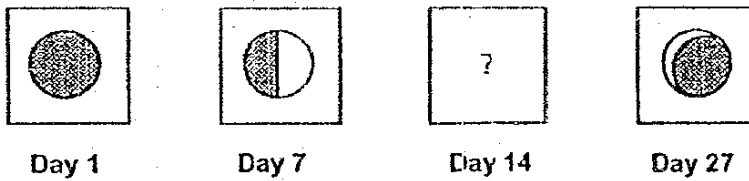

11. There is more _____ than _____ in air.

- ① nitrogen; oxygen
- ② oxygen; nitrogen
- ③ carbon dioxide; oxygen
- ④ carbon dioxide; nitrogen

12. The diagram below shows the changes in the appearance of the Moon on some days in a month.



Which of the following shows what the Moon looks like on Day 14?

- (1) 
- (2) 
- (3) 
- (4) 

13. Which of the following statements about the rotation of the Earth are correct?
- A: One half of the Earth always faces the Sun.
 - B: The Earth completes one rotation in 24 hours.
 - C: The Earth rotates on its axis from West to East.
 - D: The rotation of the Earth causes the Moon changing phases.

Which of ^{the} statements are true?

- (1) A, B and C only
- (2) B, C and D only
- (3) A, B and D only
- (4) A, ~~B~~ and D only

C

14. The diagram below shows some objects and their orbits in the Solar System.

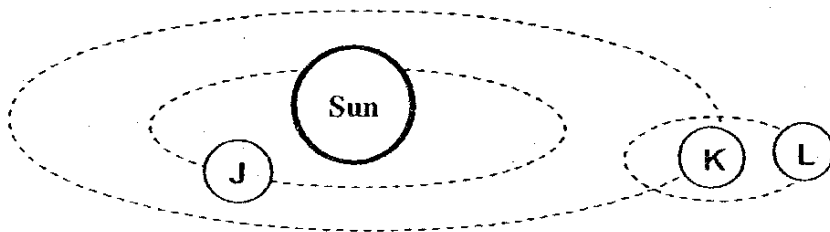

Which of the following statements can you infer based on the diagram only?

- A: L is man-made.
- B: K is a satellite of L.
- C: J and K revolve around the Sun.
- D: J will have a lower surface temperature than K.
- E: J will take a shorter time than K to complete one revolution around the Sun.

- (1) A and C only
- (2) C and E only
- (3) B, D and E only
- (4) B, C and E only

4

15. Study the diagram below carefully.

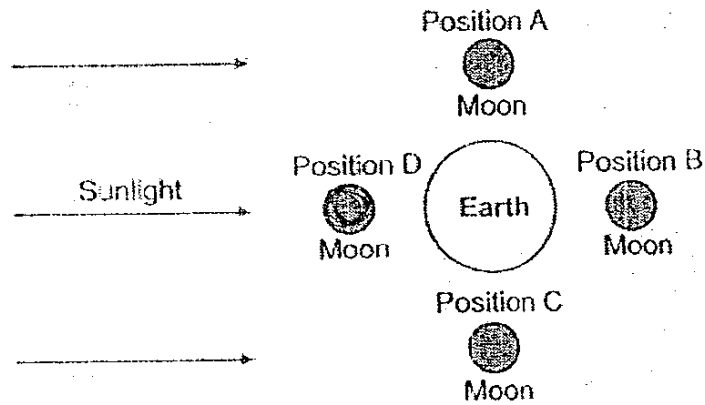

In which of the positions can you observe a new moon at night?

- (1) Position A
- (2) Position B
- (3) Position C
- (4) Position D

16. How many rotations about its axis would the Earth have made from Joseph's 12th birthday to his 14th birthday?

- (1) 2
- (2) 24
- (3) 365
- (4) 730

- (17) Look at the diagram below.

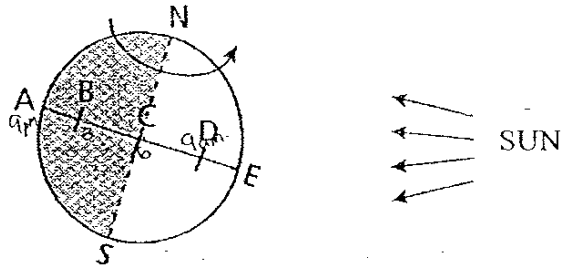

If the time at D is 9am, what would the time most likely be at B?

- (1) 3 am (2) 9 am
 (3) 12 noon (4) 9 pm

18. Peter studied the Solar System and recorded the characteristics of some objects in the table below.

Characteristics	Object W	Object X	Object Y	Object Z
Gives out light	No	No	Yes	No
Revolves around the Sun	Yes	No	No	Yes
Revolves around other planets	No	Yes	No	No
Has a great diversity of life	No	No	No	Yes
Man-made	No	Yes	No	No

Which of the following are objects W, X, Y and Z likely to be?

	Object W	Object X	Object Y	Object Z
(1)	Earth	Moon	Sun	Neptune
(2)	Jupiter	Weather satellite	Earth	Sun
(3)	Mars	Moon	Sun	Earth
(4)	Venus	Communication satellite	Sun	Earth

19. The movement of the Earth about its own axis and around the Sun brings about changes to our environment. Which one of the following correctly shows the effect of each type of movement?

	The Earth rotating about its own axis	The earth revolving around the Sun
(1)	The Sun rising in the East.	Flowers blooming in Spring.
(2)	The formation of tides.	The setting of the Sun.
(3)	Married couples celebrating their wedding anniversary.	The changes in the phases of the Moon.
(4)	The birds migrating to a warmer place.	Celebrating one's birthday.

20. Look at the table below

X	Y
Paramecium	Bird
Amoeba	Cat

Which of the following classification best represents X and Y?

	X	Y
(1)	Budding	Binary fission
(2)	Plant cells	Animal cells
(3)	Single-celled organisms	Multicellular organisms
(4)	Non-living things	Living things

21. Janet observed two cells and recorded the results in the table below. Study the table below carefully.

Cell parts	Cell A	Cell B
Cell wall	Absent	Present
Cell membrane	Present	Present
Cytoplasm	Present	Present
Nucleus	Present	Present
Chloroplasts	Absent	Present

Based on the above table, what conclusion can Janet arrive at?

- (1) Cell A is an animal cell and cell B is a plant cell.
 (2) Cell A is a red blood cell and cell B is a white blood cell.
 (3) Cell A belongs to the root of a plant and cell B belongs to a leaf.
 (4) Cell A belongs to a single-celled organisms and cell B belongs to a multicellular organism.
22. Jasper prepared two slides A and B. As he observed them through the microscope, he observed both had a fixed shape and had a cell wall. However he noticed that slide A had chloroplasts, while slide B did not. Where was the specimen for slide A and slide B taken from?

	Slide A	Slide B
<input type="radio"/> (1)	Hibiscus leaf	Amoeba
<input type="radio"/> (2)	Balsam root	Cheek cell
<input type="radio"/> (3)	Carrot root	Hibiscus root
<input type="radio"/> (4)	Elodea leaf	Onion bulb

23. Jane was trying to focus her sample and the stage was moving upwards. She then realised that the objective lens was touching the slide. However, as she was still unable to get a sharp image she decided to keep turning the focus knob in the same direction. What will happen?

- ① She will damage the slide only.
- ② She will damage the eyepiece.
- ③ She will get the sharp image she wanted.
- ④ She will damage the slide and the objective lens.

24. Which of the following statements are true of a cell membrane?

- Ⓐ It controls all the activities of the cell.
- Ⓑ It can be found only in an animal cell.
- Ⓒ It is a thin partially permeable layer.
- Ⓓ It allows some substances to enter and leave the cell.

- ① A and D only
- ② B and C only
- ③ C and D only
- ④ B, C and D only

25. An animal X had a mass of 2kg when it was 1 week old. It had a mass of 5kg when it was 4 weeks old. Which of the following would have contributed to the increase in mass?

- A: Cell growth
- B: Cell death
- C: Cell division

- ① A only
- ② C only
- ③ A and C only
- ④ B and C only

26. Jason said the following statements after studying the topic of cells.
- A: Both living and non-living things are made up of cells.
 - B: There are living things that are made up of only one cell.
 - C: Different cells have different shapes, sizes and functions.
 - D: Larger animals have larger cells than smaller animals of the same kind.

Which of the above statements are true?

- ① A and B only
- ② A and C only
- ③ B and C only
- ④ A, B, C and D

27. Three pupils, Janet, Justin and John, observed a sample slide using a microscope. Each pupil observed and recorded their observation, as shown in the table below.

Pupils	Cell parts observed
Janet	Cell membrane, nucleus
Justin	Cytoplasm, chloroplasts, nucleus
John	Cell wall, chloroplasts, nucleus

Whose records show that the cells they looked at were plant cells?

- ① John only
- ② Janet and John only
- ③ Justin and John only
- ④ Janet and Justin only

28. The table below shows some properties of three different types of material. Which one of them is correct?

Properties	Coins	Milk	Oxygen
① Has mass	Yes	No	Yes
② Occupies space	Yes	Yes	No
③ Has a definite shape	Yes	No	No
④ Can be compressed	Yes	Yes	Yes

29. Jeffery wanted to find out the effect of salt on the melting point of ice. He set up the experiment as shown below and added different amounts of salt to the ice cubes and recorded the melting point in the table below.

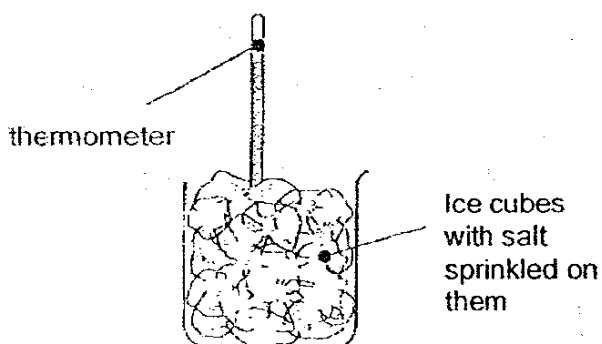

Amount of salt added (in g)	0	10	20	30
Melting point of ice (in °C)	0	-2	-3	-4

Based on the results obtained, which one of the following statements is correct?

- ① Adding salt does not affect the melting point of ice.
- ② The melting point of ice when 25g of salt was added should be -5°C .
- ③ As the amount of salt added decreases, the melting point of ice decreases.
- ④ As the amount of salt added increases, the melting point of ice decreases.

30. A room crowded with people, has all its doors and windows closed. Which one of the following shows how some of the gases will change in the room?

	Water Vapour	Oxygen	Carbon Dioxide	Nitrogen
①	Decrease	Decrease	Increase	Decrease
②	Increase	Increase	Decrease	No change
③	Increase	Decrease	Increase	No change
④	Decrease	Increase	Decrease	Increase

12

**NAN HUA PRIMARY SCHOOL
CONTINUAL ASSESSMENT 1, 2007
PRIMARY 5
SCIENCE**

Sect B	/ 40
--------	------

Name: _____ ()

Class: Primary 5 _____

Parent's Signature

SECTION B (40 marks)

Write your answers to questions 31 to 46 in the spaces provided. The number of marks for each question are shown in brackets () at the end of each question or part question.

31. Label the main parts of the microscope in the diagram below using the helping words given in the box. (3m)

power-switch	focus-knob	lamp
objective-lens	eyepiece	stage

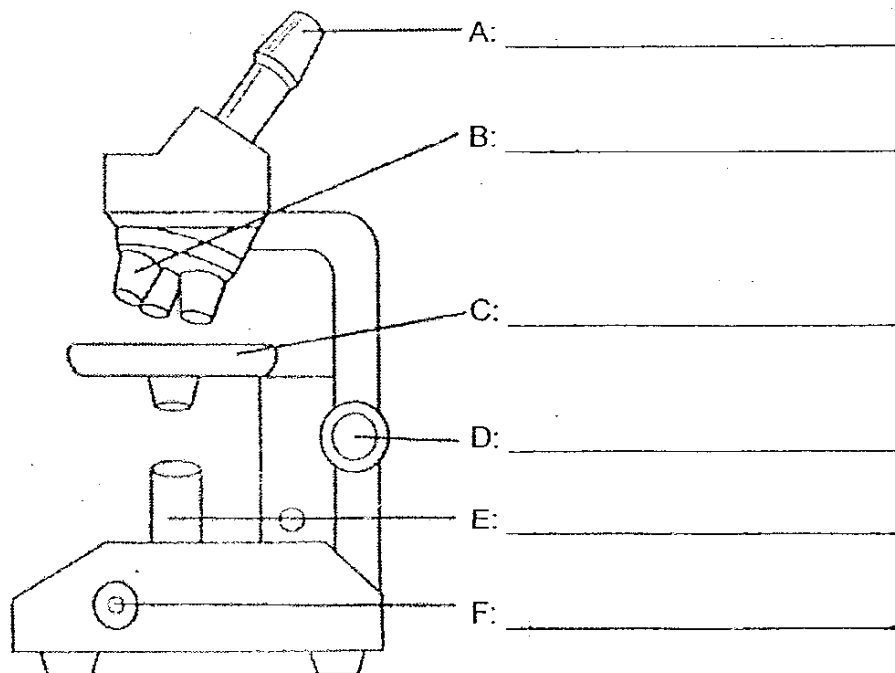

14

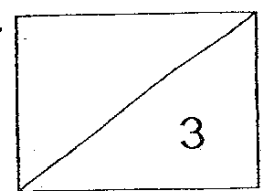

32. Study the flow chart about the Solar System below.

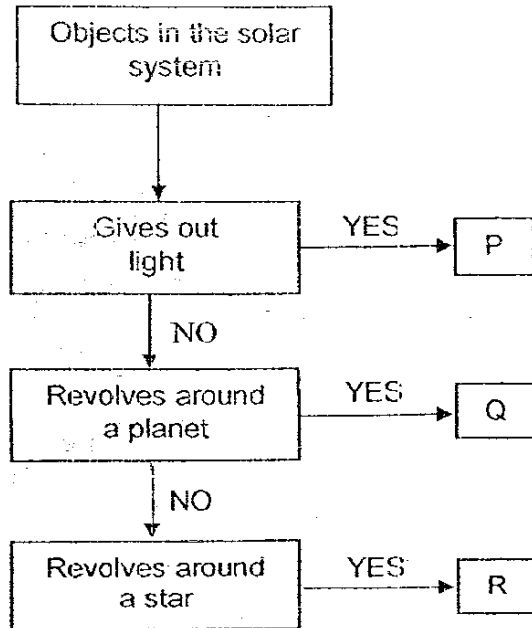

a) Name the P and Q in the solar system. (1m)

P is _____

Q is _____

b) From the information given above, answer the following questions related to R. (2m)

i) Name R.

ii) How long does R take to complete one revolution around the star?

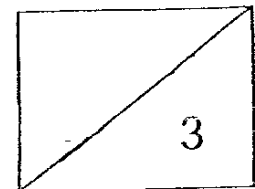

33. The following is a list of objects that are found in space.

Moon	Sun	Planets
Star	Man-made satellites	Earth

Two of the objects above have been classified for you in the classification table below. Complete the classification table by:

- Giving suitable headings, (i) and (ii), to the classification table below. (1m)
- Classifying the rest of the objects given in the box above, in the lines provided below. (2m)

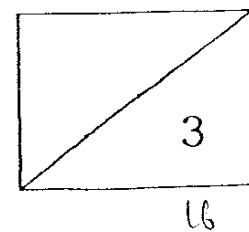
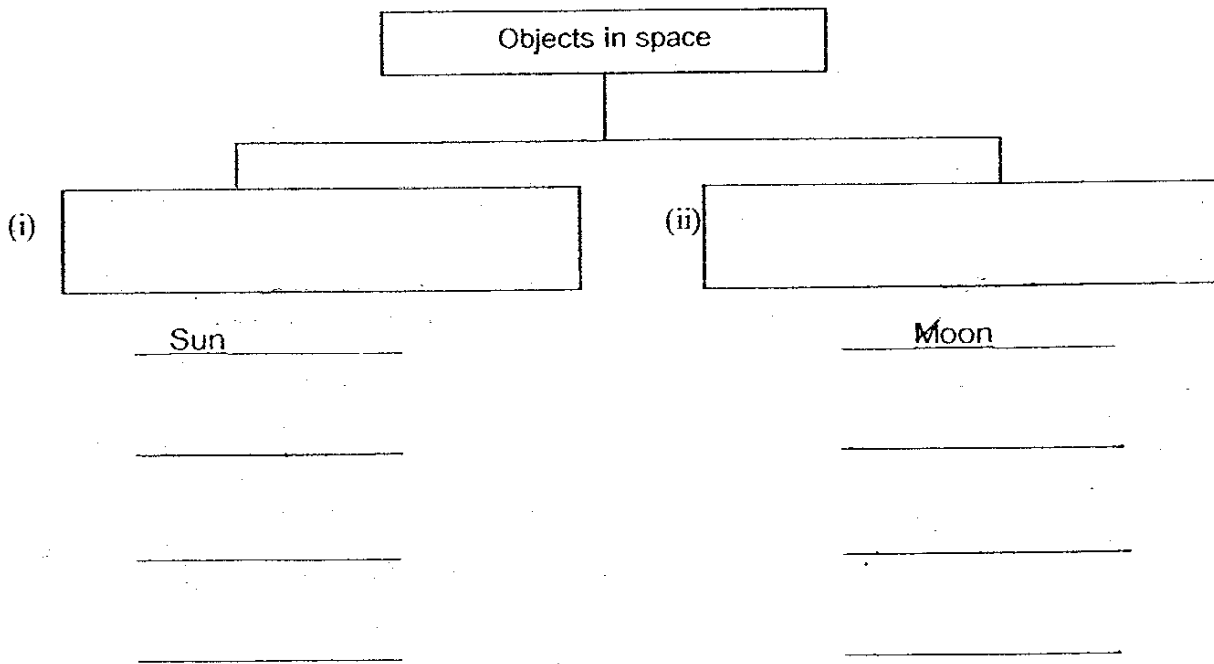

34. The diagram below shows the parts of a plant cell,

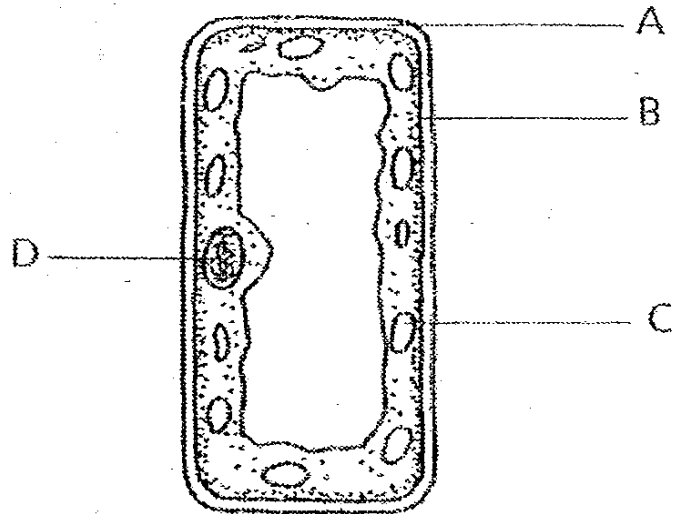

Study the diagram and give the name of the part and its function in the table below. (4m)

Parts of plant cell	Function
A:	
B:	
C:	
D:	

17

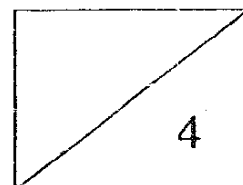

35a) State the use of a microscope?

(1m)

b) Where would you place a specimen slide when using a microscope?

(1m)

36. Study the diagram and the table below.

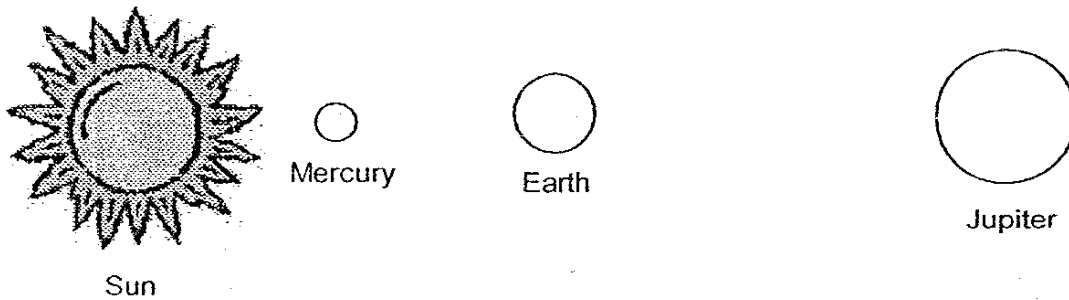

	Planets		
	Mercury	Earth	Jupiter
Distance from the Sun (million km)	58	150	778
Temperature (Average temperature in the day)	480 °C	25 °C	-148 °C
Presence of water	No	Yes	No

Using the information given in the table above, give **two** reasons why the Earth is able to support life as compared to the other two planets. (2 m)

(i) _____

(ii) _____

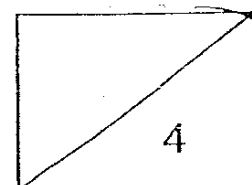

37. The picture below shows an object found in space.

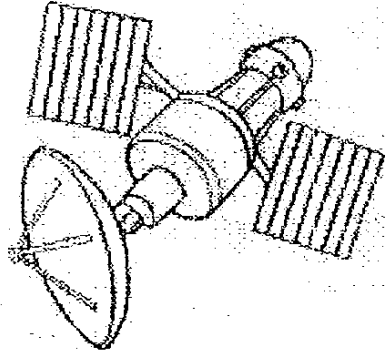

(a) What is this object known as?

(1 m)

(b) List **two** uses of this object.

(1 m)

9

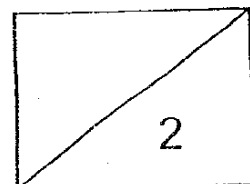

38. John was recording his observations of an object in space from his room every day. The observations were neatly tabulated in his Science Journal. One day, when he left his room, his cat toppled the ink bottle he was using for art. In the figure below see what was left after the ink spill.

Observation of _____

- It rises in the East and _____
- It can be very bright.
- It seems to be one of the largest objects up in the sky.
- It cannot be seen on a cloudy day.
- It is seen clear at night.
- Its shape seems to change.

(a) What was he observing? (1m)

(b) He says "it can be very bright". Does it mean the object is a light source? Explain your answer. (2m)

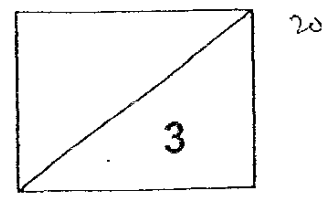

39. Janet set up an experiment as shown below. Study the diagram carefully:

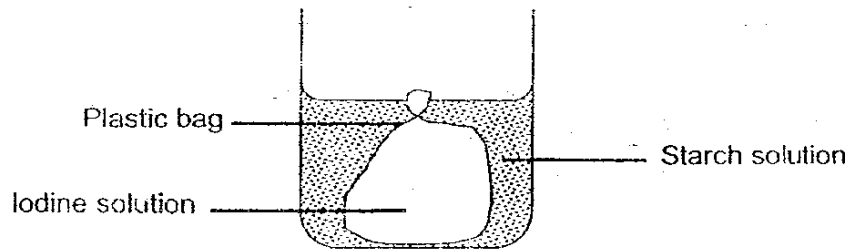

a) What will happen after sometime? (1m)

b) Which part of the cell does the plastic bag function as? (1m)

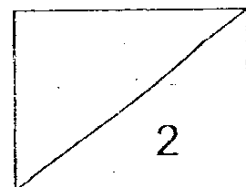

40. The graph below shows the total amount of light shining on the Moon measured using a special equipment. The measurements were made everyday for one complete month.

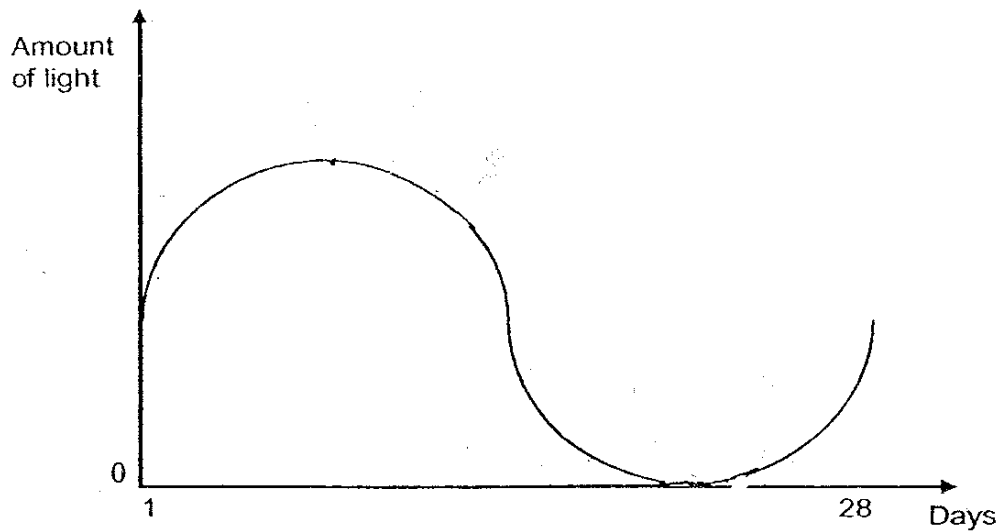

On the graph above, draw an arrow and label it as

- (a) '**full moon**' to show when there was a full moon. (1 m)
(b) '**new moon**' to show when there was a new moon. (1 m)

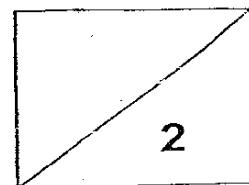

41. The diagram below shows a cell in a multicellular organism undergoing a certain process.

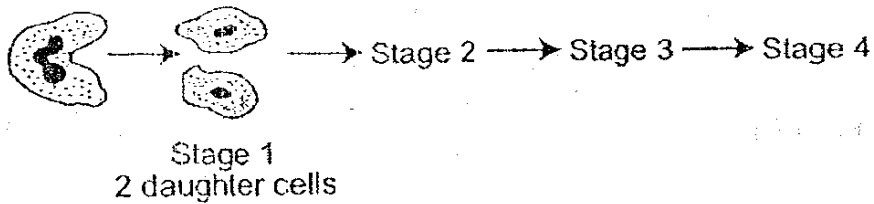

- a) Name the process that is taking place. (1m)
- _____
- b) What is the purpose of the process stated in (a)? (1m)
- _____
- c) How many cells will there be at Stage 4? (1m)
- _____

42. Josephine carries out an investigation with a plant cell and an animal cell. She places a plant cell and an animal cell in pure water.

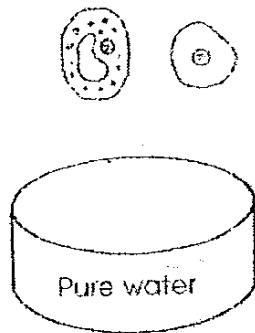

She observes that the plant cell remains tight and firm whereas the animal cell becomes swollen and eventually bursts. Explain the observations. (2m)

23

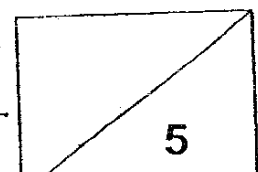

43. Susan grew a culture of yeast cells and another culture of bacteria. She counted the number of yeast cells and bacterial cells under a microscope and plotted the table and graph below.

Time (min)	0	20	40	60	80	100	120
No. of yeast cells	5	5	5	10	10	10	20
No. of bacterial cells	5	10	20	40	80	160	240

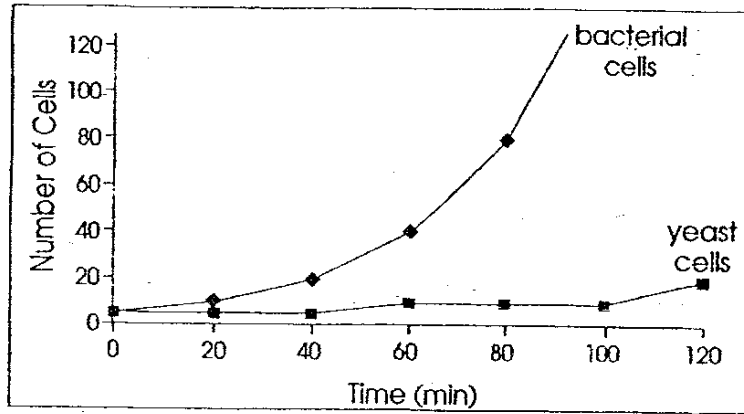

- a) What is the time taken to double: (1m)
- i) the number of yeast cells?
- _____
- ii) the number of bacterial cells?
- _____
- b) What do the results tell you about the division of bacterial cells when compared to the yeast cells? (1m)
- _____
- _____

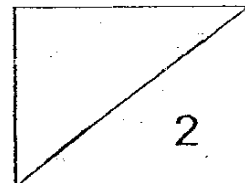

44. Jonathan had three substances A, B and C. He wanted to find out if they were a solid, liquid or gas. He tested the substances and recorded his results in the table below.

Test	A liquid	B gas	C solid
Does it have mass?	Yes	Yes	Yes
Does it occupy space?	Yes	Yes	Yes
Can it flow?	Yes	Yes	No
Can it be compressed?	No	Yes	No

- a) What is the state of matter for substance B? Explain your answer. (1m)

- b) What is the state of matter for substance C? Explain your answer. (1m)

45. Study the experimental set up below.

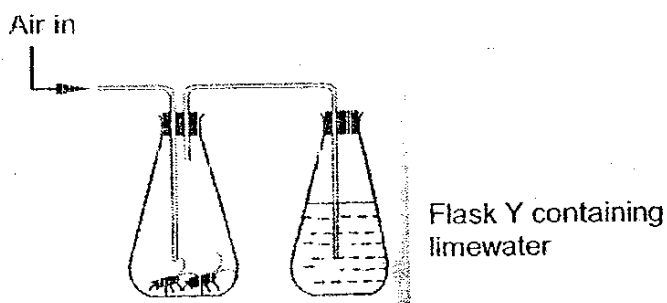

- a) What will happen to the lime water in flask Y after some time? (1m)

- b) Explain your answer in (a). (1m)

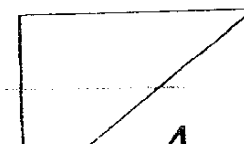

46. Two identical basins A and B were each filled with the same amount of water and left in two different places as shown in the diagram below.

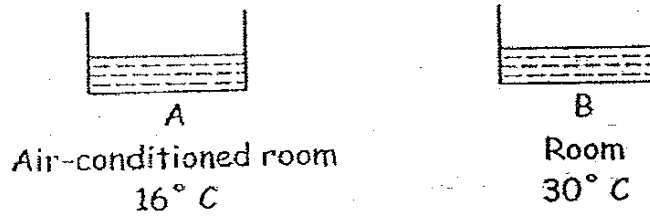

After 6 hours, the amount of water left in the two containers was measured.

- a) Which basin would have more water? (1m)

- b) Explain your answer in (a). (2m)

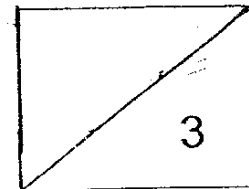

26
Have you checked your paper? ☺

26

End of paper

Nan Hua Primary School
 Primary 5 Science CA1 Exams (2007)

Answer Keys

SECTION A : (60 MARKS)

Qn no.	Ans
1	2
2	3
3	2
4	1
5	1
6	2
7	3
8	2
9	3
10	1

Qn no.	Ans
11	1
12	1
13	1
14	2
15	4
16	4
17	1
18	4
19	1
20	3

Qn no.	Ans
21	1
22	4
23	4
24	3
25	3
26	3
27	3
28	3
29	4
30	3

SECTION B (40 MARKS)

- 31a. Eyepiece
- 31b. Objective lens
- 31c. Stage
- 31d. Focus Knob
- 31e. lamp
- 31f. Power switch

- 32a. P is the sun. Q is the moon.
- 32b (i). It is planet (Earth).
- 32b (ii). It takes 365 1/2 day to complete one revolution around the star.

- 33a (i). Give out its own light.
- 33a (ii). Does not give out its own light.
- 33b. Sun: Star Moon: Man-made satellites
 Planets
 Earth

- 34a. Cell wall : It supports the plant cell. It gives the plant cell a regular shape.
- 34b. Cell membrane : The cell membrane controls the substances that move in and out of the cell. It surrounds and holds the cytoplasm inside it.
- 34c. Chloroplast : The chloroplast contains chlorophyll that traps sunlight for the plant to photosynthesis.
- 34d. The nucleus is the control centre which controls all the activities in the cell. The nucleus is responsible for cell division.
- 35a. A microscope magnifies object up to several hundreds.
- 35b. I would place it on the stage.

36 (i). Compared to Earth, Mercury is nearer to the sun so it is too hot for living thing to stay alive while Jupiter is further from the sun and receives too little heat for living thing to stay alive.

36 (ii). Earth has water which is essential for the survival of living things while Jupiter and Mercury do not have water.

37a. This object is known as man-made satellite.

37b. It is used for observation of Earth.

It is used for space exploration.

38a. He was observing the Moon.

38b. No. The Moon does not give out its own light, it reflects light from the sun, a star gives out light but the moon is not a star, it is a natural satellite, which does not give out light.

39a. The starch solution turns dark blue.

39b. The plastic bag function as the cell membrane that is partially permeable because it allows only certain substances to pass through but not others.

40.

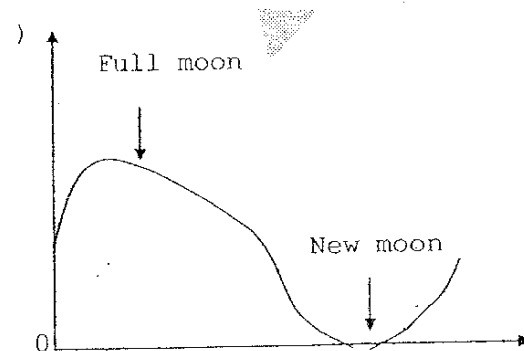

41a. The process is cell division.

41b. It is for growth and replacement of old and damaged cells in plants and animal.

41c. $2 \times 2 \times 2 \times 2 = 16$. There will be 16 cells.

42. The plant cell has a cell wall, which is tough and will support the plant cell against the forces of the excess water but the animal cell does not have a cell wall so it bursts.

43a (i). It takes 60 minutes.

43a (ii). It takes 20 minutes.

43b. The bacteria cells takes only 20 minutes to double the number while the yeast cells takes 60 minutes to double the number. This shows that bacteria cell divide more quickly than yeast cells.

- 44a. It is a gas. It can flow and can be compressed. It also has mass occupies space.
- 44b. The state of matter is solid. It cannot flow and cannot be compressed. It also has mass and occupies space.
- 45a. Chalky.
- 45b. During respiration, the insects in the flask take in oxygen and give out carbon dioxide. The limewater turns chalky when it comes in contact with carbon dioxide.
- 46a. The basin in the air-conditioned room.
- 46b. The higher the temperature of the surrounding the faster the rate of evaporation. The temperature is higher in the room (30° C) than in the air-conditioned room (16° C), so water evaporates faster in the room. Thus, the basin in the air-conditioned room will have more water.