

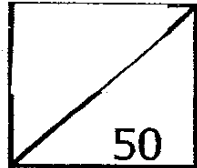

**Rosyth School**  
**Second Continual Assessment for 2007**  
**SCIENCE**  
**Primary 5**



Name: \_\_\_\_\_

Total  
Marks:

Class: Pr 5 \_\_\_\_\_

Register No. \_\_\_\_\_

Duration 1 h 15 min

Date: 23<sup>rd</sup> August 2007

Parent's Signature: \_\_\_\_\_

Instructions to Pupils:

1. Do not open the booklet until you are told to do so.
2. Follow all instructions carefully.
3. This paper consists of 2 sections, Section A and Section B.
4. For questions 1 to 15, shade the correct ovals on the Optical Answer Sheet (OAS) provided using a 2B pencil.
5. For questions 16 to 23, give your answers in the spaces provided in Section B.

	Maximum	Marks Obtained
<b>Section A</b>	<b>30 marks</b>	
<b>Section B</b>	<b>20 marks</b>	
<b>Total</b>	<b>50 marks</b>	

\* This booklet consists of 16 pages. (pg. 1 to 16)

This paper is not to be reproduced in part or whole without the permission of the Principal.

✓

**Section A (30 Marks)**

For each question from 1 to 15, four options are given. One of them is the correct answer. Make your choice (1, 2, 3 or 4). **Shade the correct oval (1, 2, 3 or 4) on the Optical Answer Sheet.**

1. Glen places some organisms under the sun. The following are the organisms.

- A: A plant growing in a pot.  
B: A fish tank with some guppies swimming in it.  
C: A dish of germinating seeds on wet cotton wool.

Which of the above organism(s) is/are respiring?

- (1) B only  
(2) A and B only  
(3) B and C only  
(4) A, B and C

2. Study the food chain below.



In the above food chain, which of the following best describes the lion?

- A: Prey  
B: Predator  
C: Carnivore  
D: Food producer

- (1) A and B only  
(2) B and C only  
(3) C and D only  
(4) A, B and C only

3. A cockroach is placed in a container as shown in the diagram below.

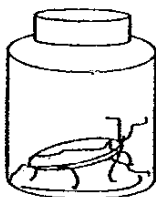

Which of the following graphs correctly shows the changes in the volume of carbon dioxide and oxygen in the container over a period of time?

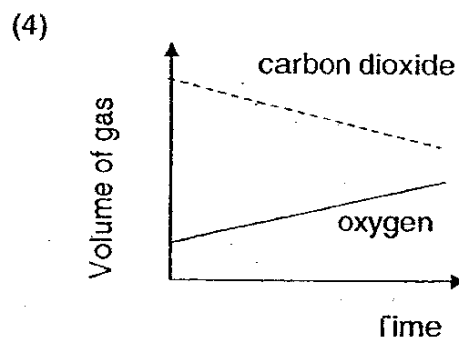
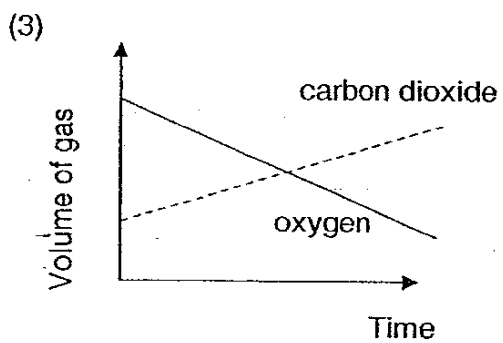
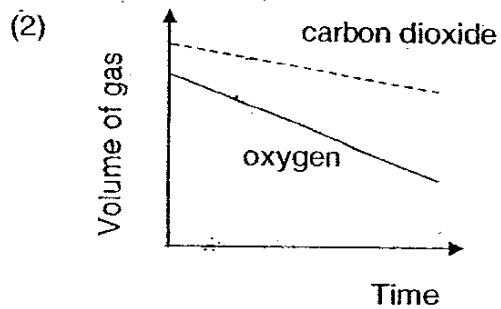
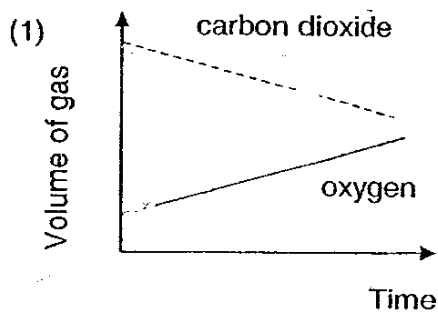

54

4. The table below shows a comparison between photosynthesis and respiration.

	Photosynthesis	Respiration
A ✓	Produces oxygen.	Produces carbon dioxide.
B ✓	Energy is stored in food substances.	Energy is released from food substances.
C	Takes place in plant cells.	Takes place only in animal cells.
D ✓	Takes place during the day or when there is enough light.	Takes place at all times.

Which of the following comparisons are true?

- (1) A and B only  
 (2) B and C only  
 (3) A, B, and D only  
 (4) B, C and D only
5. Steve carried out an experiment using four identical set-ups, like the one shown below. He placed them in four different locations W, X, Y and Z.

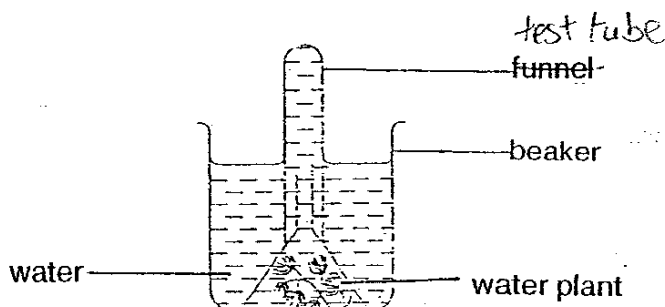

Three days later, he recorded the volume of oxygen collected in each set-up in a table, as shown below.

Place where set-up is located	W	X	Y	Z
Volume of oxygen collected (cm <sup>3</sup> )	1	3	2	6

Based on the results, which one of the following shows the correct order from the most to the least favourable location for photosynthesis?

- (1) W, Y, X, Z  
 (2) W, Z, Y, X  
 (3) X, Y, W, Z  
 (4) Z, X, Y, W

6. Study the diagram below carefully.

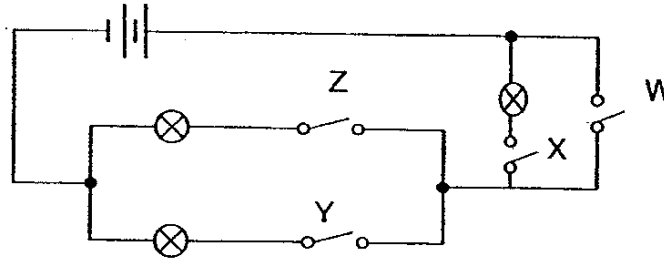

Which switches must be closed for 2 bulbs in the circuit to be lit?

- A: W and X
- B: X and Y
- C: X and Z
- D: Y and Z

- (1) A and B only
- (2) B and C only
- (3) B, C and D only
- (4) A, B, C and D

7. Study the diagram below.

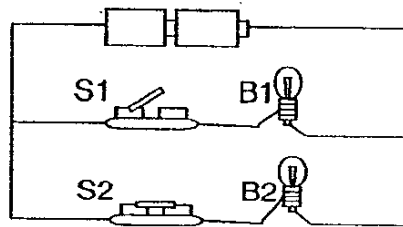

Which of the following circuit diagrams best represents the electric circuit given?

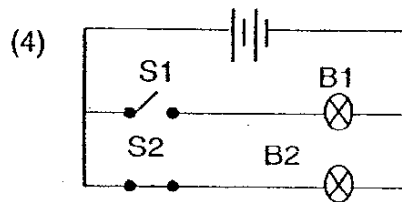
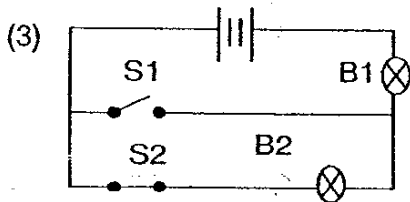
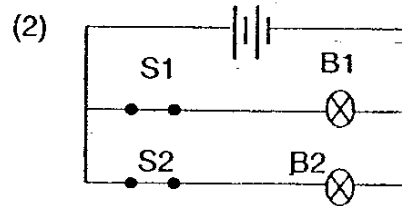
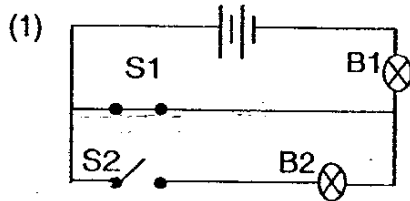

26

8. Timothy tested a circuit card for the possible connections and recorded his results in the table below.

Clips Tested	Did bulb light up?
E and G	Yes
E and H	No
F and G	Yes
F and H	No

Which of the following diagrams shows a possible connection of the clips?

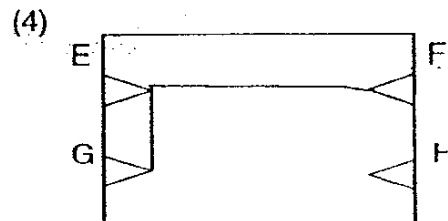
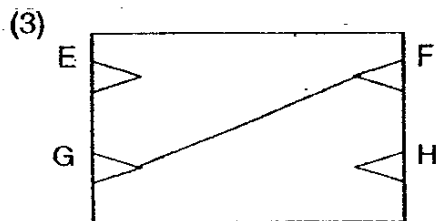
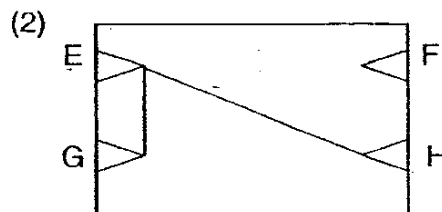
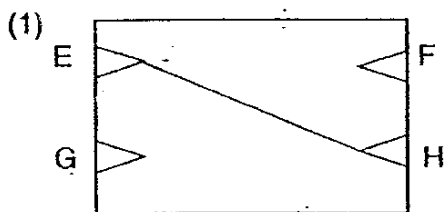

9. Ming Wei wanted to find out which bulb will be the brightest in an electrical circuit.



2.5 V



3.8 V



6 V

Which of the following variables should be kept the same to ensure a fair test?

- A: Type of bulb used.
- B: Type of batteries used.
- C: Arrangement of batteries:
- D: Number of batteries used.

- (1) A, B, and C only
- (3) B, C and D only

- (2) A, C and D only
- (4) A, B, C and D

10. Lilian sets up four circuits using identical batteries, bulbs and wires.

Circuit J

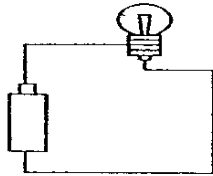

Circuit K

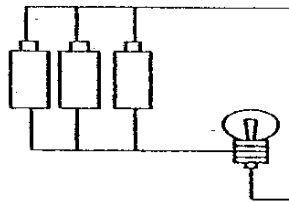

Circuit L

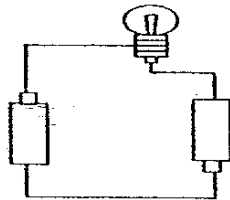

Circuit M

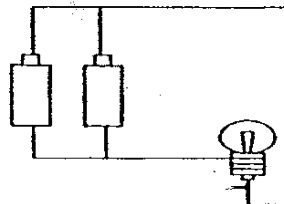

In which of the circuits will the bulbs be of equal brightness?

- (1) J and K only
- (3) J, K and M only

- (2) K and L only
- (4) J, K, L and M

11. Look at the circuit diagram below.

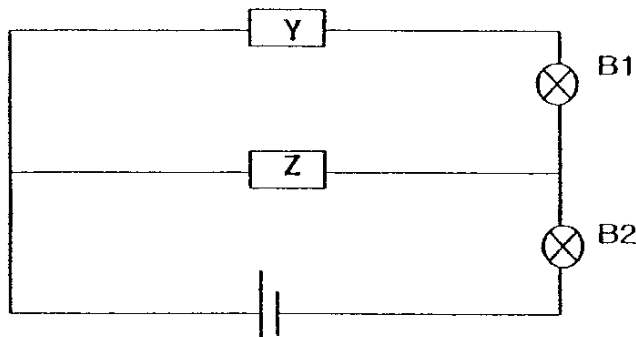

2 objects are placed at Y and Z so that only bulb B2 will light up. Which one of the following items could represent Y and Z?

	Y	Z
(1)	Toothpick	Gold ring
(2)	1-cent coin	Glass bulb
(3)	Gold ring	1-cent coin
(4)	Glass bulb	Toothpick

Study the flow chart below and answer Questions 12 and 13.

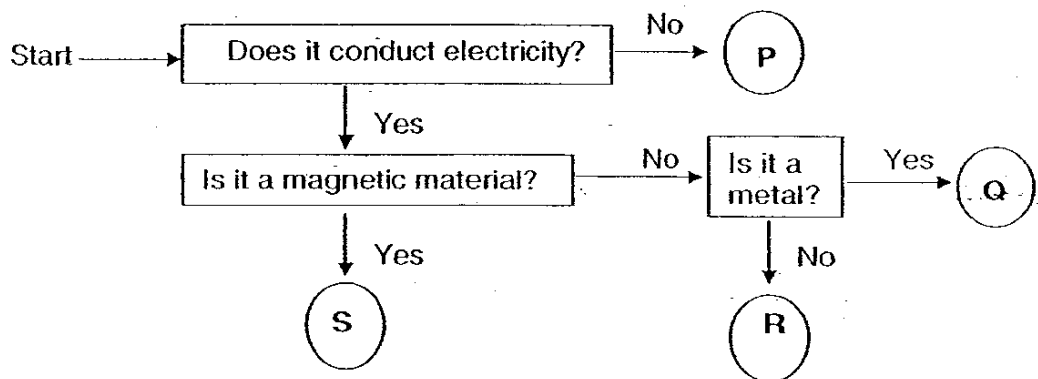

12. What object can Q be?

- (1) Iron pin
- (2) Lemon Juice
- (3) Mercury
- (4) Wooden ruler

13. Which of the following objects can be classified together with object 'P'?

- (1) Salt solution
- (2) Copper coin
- (3) Silver ring
- (4) Plastic comb

59





**Section B (20 Marks)**

For questions 16 to 23, write your answers in this booklet.

16. Bobby tested some food with iodine and recorded the results in a table as shown below.

Food	Changes Observed
Flour	Iodine turned dark blue
Dried Shrimp	Iodine remained brown
Tapioca	Iodine turned dark blue
Potato	Iodine turned dark blue
Beef	Iodine remained brown

- (a) What do you think Bobby was trying to find out? (1m)

---

---

- (b) Based on the results, state the difference in the food that comes from plants and the food that comes from animals. (1m)

---

---

17. The six arrows in the diagram below show the exchange of gases between living things and their surroundings.

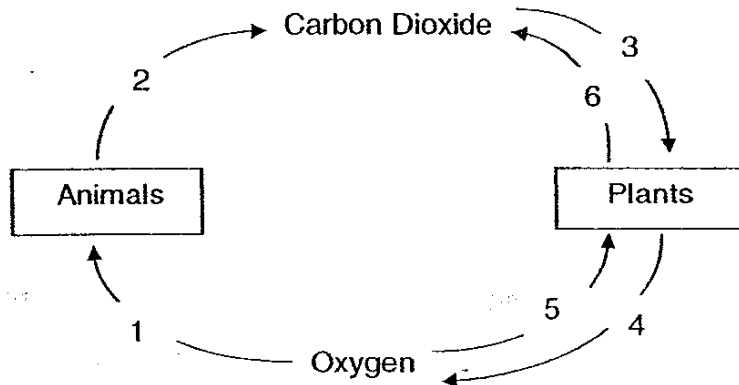

- (a) Which two arrows show the process of photosynthesis? (1m)

Arrows \_\_\_\_\_ and \_\_\_\_\_.

- (b) Name another product beside the gas that is represented by the arrows in (a) that is formed during photosynthesis. (1m)

b)

18. The graph below shows the amount of oxygen produced by plants in an enclosed container. The intensity of the light is the highest at 12 noon.

(a) Part of the graph (from 6 am to 10 am) has been drawn for you. Complete the rest of the graph to show the amount of oxygen produced by the plant from 10 am to 6 pm. (2m)

Amount of oxygen produced

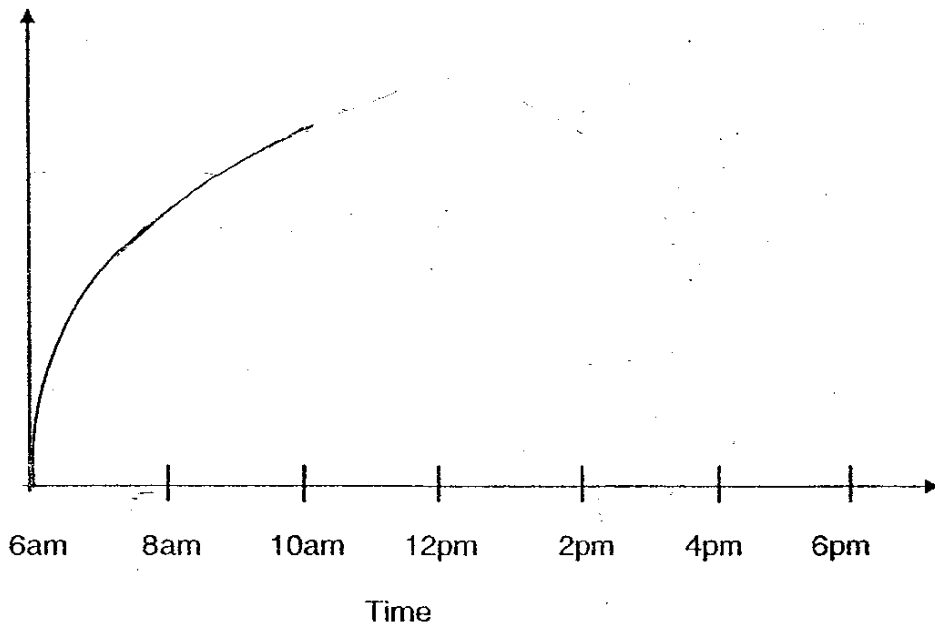

(b) State the relationship between the intensity of the light and the rate of photosynthesis. (1m)

19. The diagram below shows 4 lit bulbs A, B, C and D in a circuit. A switch is to be installed so that only a particular bulb can be switched on and off while the other 3 remained lit.

(a) Where should a switch be placed in the circuit such that it controls only 1 bulb?

Mark an 'X' on the circuit to show where the switch should be. (1m)

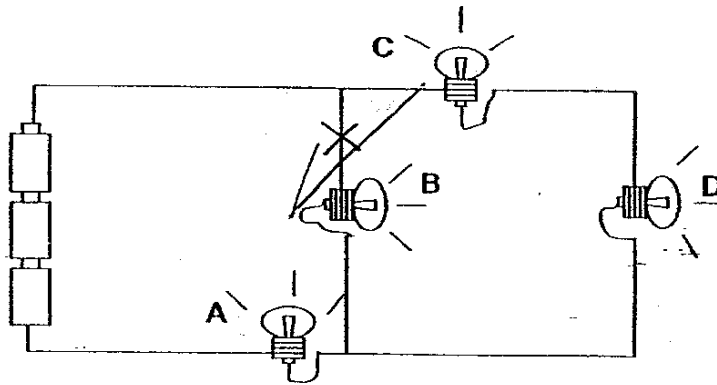

(b) Which bulb (A, B, C or D) does the switch control? (1m)

20. David wanted to find out whether liquid X or liquid Y is a better conductor of electricity. Using the materials given below, how should he carry out the experiment.

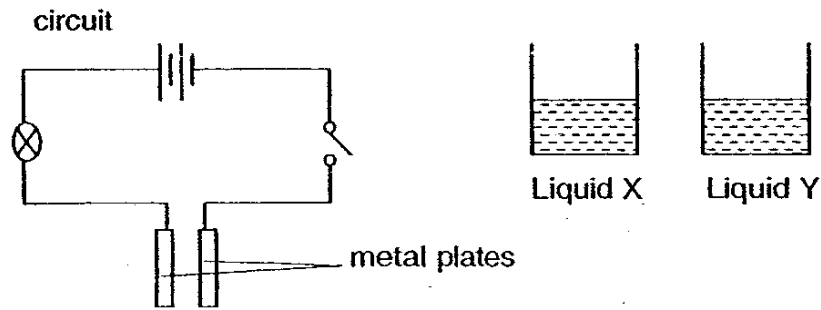

- (a) Write the steps in the box below. (2m)

Steps to carry out

- (b) From the experiment above, how can David conclude which liquid is a better conductor of electricity. (1m)

---

---

66

21. Raj set up an experiment as shown below.

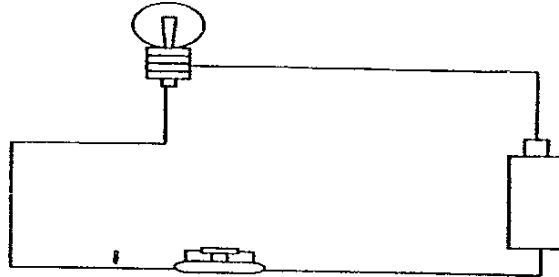

He repeated the experiment with different number of batteries. The results of this experiment are represented by the graph shown below.

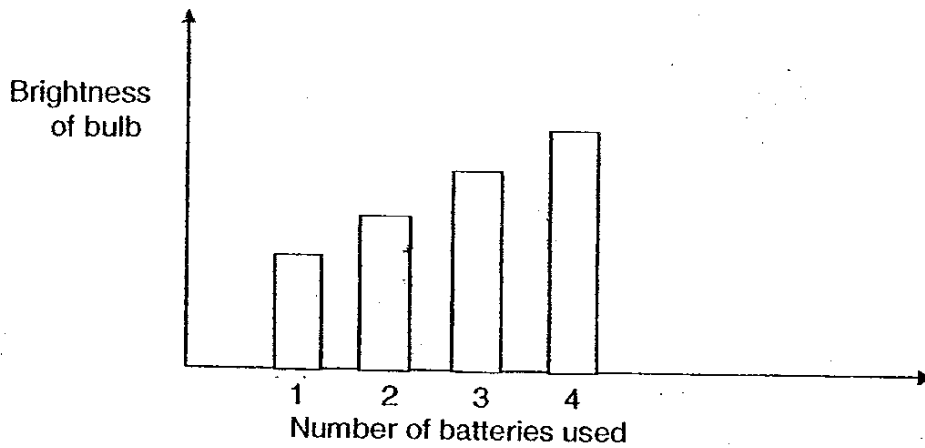

(a) What was Raj trying to find out from the above experiment? (1m)

---

---

(b) When a fifth battery was added to the circuit, the bulb did not light up. Explain why? (1m)

---

---

22. Study the circuit diagram below.

**Circuit A**

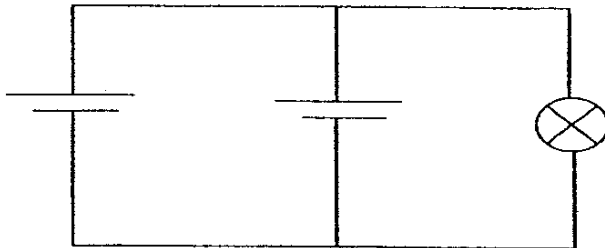

(a) Using the same components as above, draw another circuit diagram in the box below such that the bulb will be brighter. (2m)

**Circuit B**

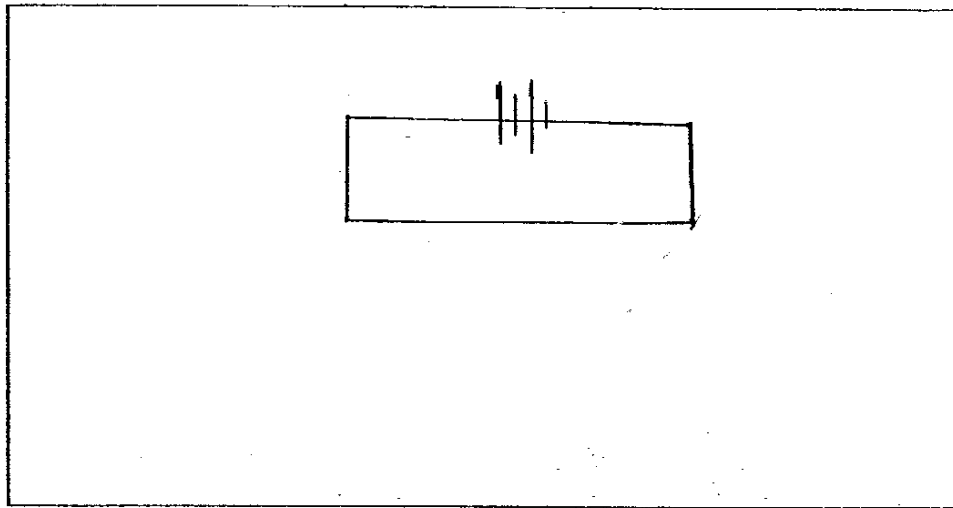

(b) Name one disadvantage of the above arrangement that you have drawn. (1m)

---

---



23. Study the two circuits G and H carefully.

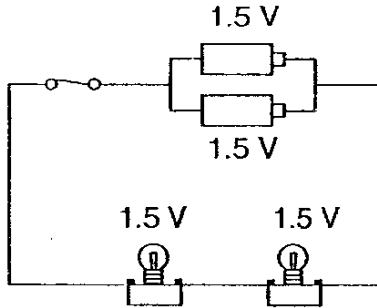

Circuit G

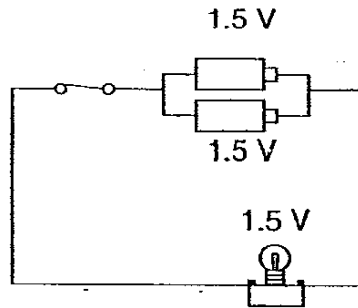

Circuit H

- (a) Write down the similarity in the arrangement of batteries between Circuits G and H. (1m)

---

---

- (b) In what way is Circuit G different from Circuit H in terms of brightness of the bulbs? (1m)

---

---

- (c) What will happen to the brightness of the bulb(s) if one battery is removed from each circuit? (1m)

---

---

End of Paper

Rosyth Primary School

Primary 5 Science CA2 Exams (2007)

**Answer Keys**

**SECTION A : (60 MARKS)**

Qn no.	Ans
1	4
2	2
3	3
4	3
5	4
6	2
7	4
8	4
9	3
10	3

Qn no.	Ans
11	1
12	3
13	4
14	1
15	3

**SECTION B (40 MARKS)**

- 16a. Bobby was trying to find out which food contain starch.  
16b. Food that comes from plants contains starch as the plants can make food on their own, where as animal cannot make food on their own and have to depend on others for food thus, animal do not have starch

- 17a. 3 and 4  
17b. Sugar / glucose

18a.

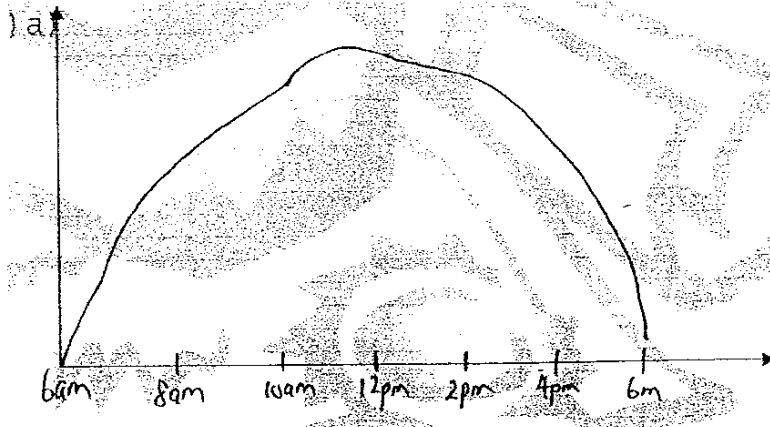

- 18b. The greater the intensity of the light, the faster the rate of photosynthesis

19a.

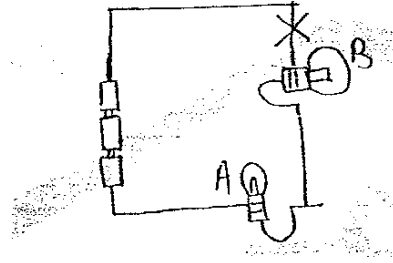

19b. The switch controls bulb

20a. First, insert the metal plant into liquid X. Then, close the switch and record the brightness of the bulb. Next, open the switch and remove the metal plates from liquid X and place it in to liquid Y. Close the switch and record the brightness of the bulb. Finally take out the metal plates from liquid Y and compare the recordings.

20b. The brighter the bulb shone when the metal plates are placed into liquid, the better conductor of electricity it is .

21a. He was trying to find out if the number of batteries would effect the brightness of the bulb.

21b. The filament became too hot and melted.

22a.

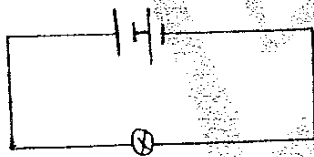

22b. The batteries will be used up faster

23a. They are arranged in parallel .

23b. The bulb in circuit H will be bright than those in circuit G.

23c. They will remain the same when one battery is removed from each circuit .