

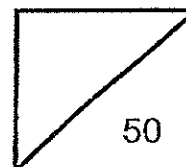

Rosyth School
Continual Assessment 2 for 2014
STANDARD SCIENCE
Primary 5



Name: _____

Total
Marks:

Class: Pr 5 _____

Register No. _____

Duration: 1 h 15 min

Date: 21 August 2014

Parent's Signature: _____

Instructions to Pupils:

1. Do not open the booklet until you are told to do so.
2. Follow all instructions carefully.
3. This paper consists of 2 Parts, Part I and Part II.
4. For questions 1 to 15 in Part I, shade the correct ovals on the Optical Answer Sheet (OAS) provided using a 2B pencil.
5. For questions 16 to 23, give your answers in the spaces given in the Part II.

| | Maximum | Marks Obtained |
|----------------|-----------------|-----------------------|
| Part I | 30 marks | |
| Part II | 20 marks | |
| Total | 50 marks | |

This booklet consists of 20 pages.

This paper is not to be reproduced in part or whole without the permission of the Principal.

Part I (30 Marks)

For each question from 1 to 15, four options are given. One of them is the correct answer. Make your choice (1, 2, 3 or 4). Shade the correct oval (1, 2, 3 or 4) on the Optical Answer Sheet.

1. The diagram shows the female reproductive system.

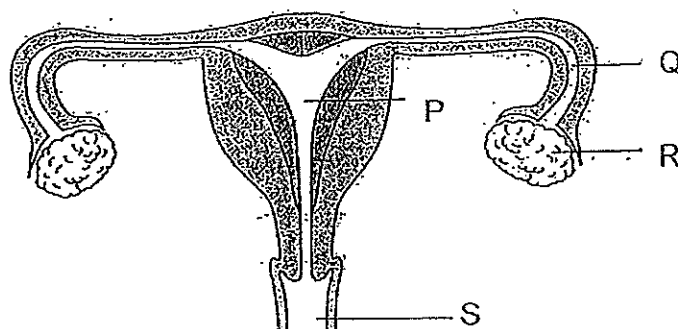

In which part is the egg formed and the foetus developed?

| | Formation of Egg | Development of Foetus |
|-----|------------------|-----------------------|
| (1) | R | P |
| (2) | Q | R |
| (3) | S | R |
| (4) | S | P |

2. Which of the following statements are true?

A: Sperms are produced by the males.
 B: Eggs of all animals have hard shells.
 C: Reproduction is a way to prevent extinction of a species.
 D: When all living things reproduce, a sperm and an egg is needed.

- (1) A and C only (2) B and D only
 (3) A, C and D only (4) A, B, C and D

3. Which one of the following shows the correct sequence of reproduction in flowering plants?

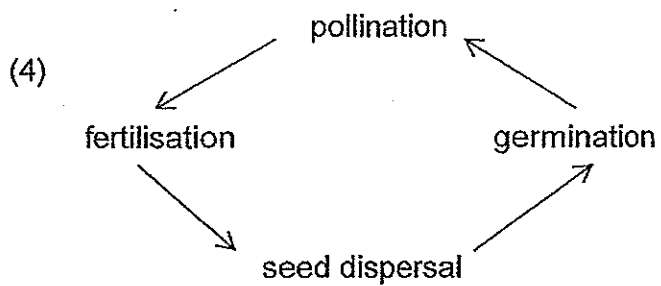
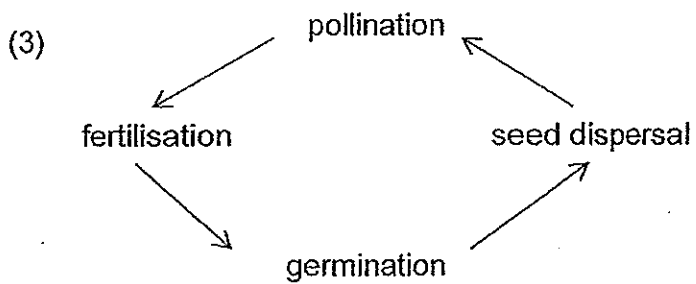
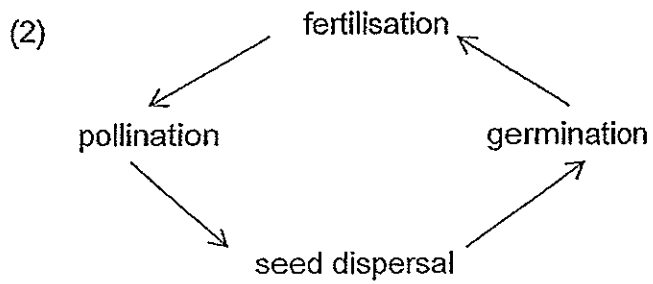
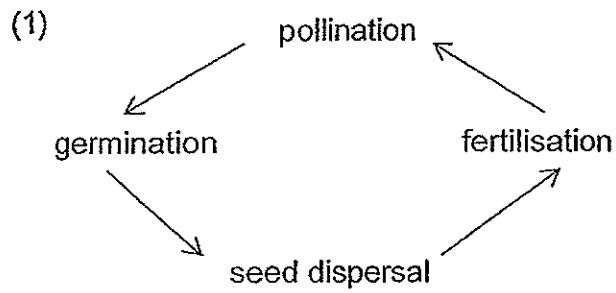

4. The parts of a seed are shown in the diagram below.

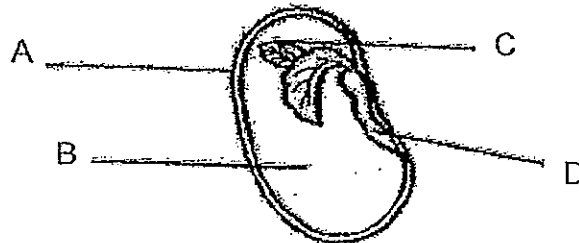

Which part of the seed provides food for the seedling?

- (1) A (2) B
(3) C (4) D
5. Timothy carried out an experiment to find out if the colour of a flower would affect the number of insects it attracted. The table below shows the characteristics of four types of flower K, L, M and N.

| Flower | Petal | | Smell |
|--------|-------|-------------------|-----------|
| | Size | Colour | |
| K | Large | Brightly-coloured | Scented |
| L | Small | White | Scented |
| M | Large | White | Scented |
| N | Small | Brightly-coloured | Unscented |

Which two flowers should he choose in order to conduct a fair experiment?

- (1) K and M (2) L and N
(3) K and L (4) M and N

6. Susan conducted an experiment using 2 seedlings of the same type. She ensured that the variables for her experiment were as stated in the table below.

| Types of Variable | Variable |
|---------------------|------------------------|
| Changed Variable | Amount of fertilizers |
| Measurable Variable | Height of the seedling |
| Unchanged Variables | Amount of water |
| | Intensity of light |

Based on the information given above, what was the likely aim of the experiment?

- (1) To find out if the intensity of light affects the growth of the seedlings.
 - (2) To find out if the height of the plant affects the growth of the seedlings.
 - (3) To find out if the amount of water given affects the growth of the seedlings.
 - (4) To find out if the amount of the fertilizer given affects the growth of the seedlings.
7. The following diagram shows parts of a flower.

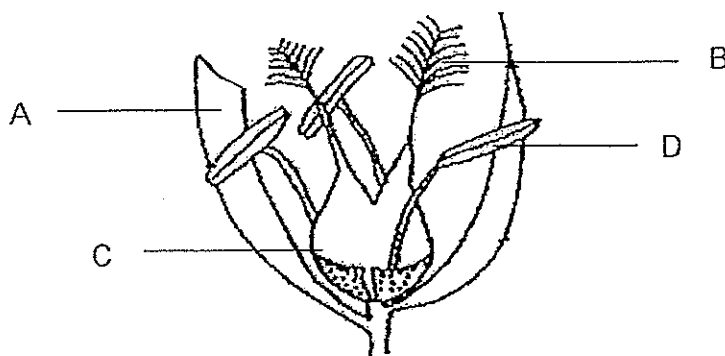

Which of the following statements correctly describes the function of each part?

| Part | Function |
|------|---------------------------|
| A | Protects the egg cell |
| B | Receives the pollen grain |
| C | Protects the anther |
| D | Protects the pollen grain |

- (1) A and C only
- (2) B and D only
- (3) B, C and D only
- (4) A, B and D only

8. The diagram shows the water cycle.

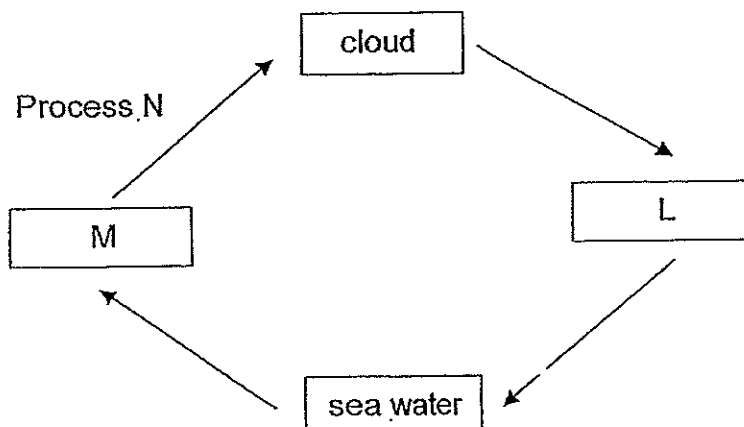

Which one of the following is correct?

| | L | M | Process N |
|-----|--------------|--------------|--------------|
| (1) | water vapour | rain | evaporation |
| (2) | rain | water vapour | evaporation |
| (3) | water vapour | rain | condensation |
| (4) | rain | water vapour | condensation |

9. Which of the following underlined substances gain heat energy in the given situations?

A: Ice melting in a glass of orange juice

B: Water evaporating from the ocean

C: Water droplets forming on a leaf surface in the morning

D: Ice pack placed on the forehead of a person with high fever

(1) A and C only

(2) B and D only

(3) A, B and C only

(4) B, C and D only

10. 25ml of water was poured into four different containers and left on the table at room temperature.

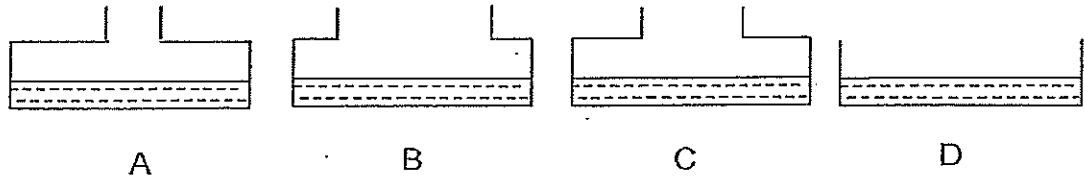

Which one of the following graphs most accurately shows the amount of water evaporated from each container?

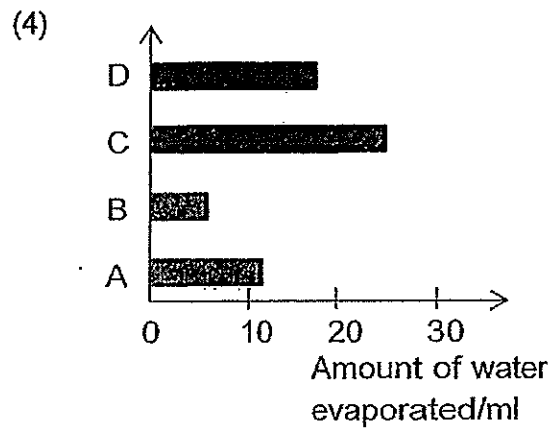
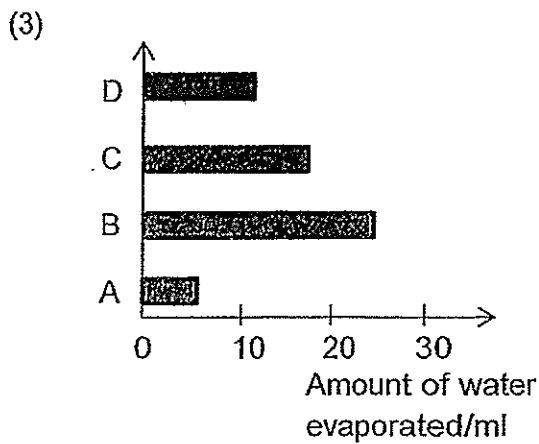
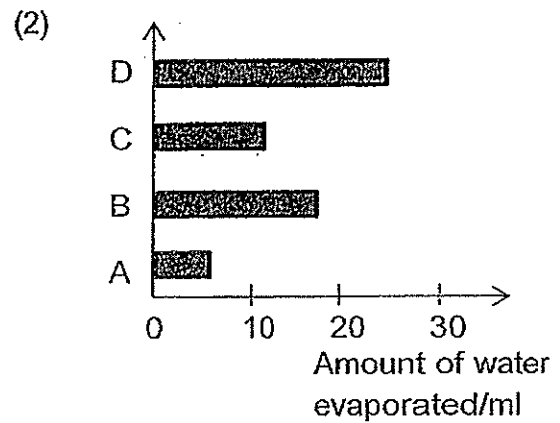
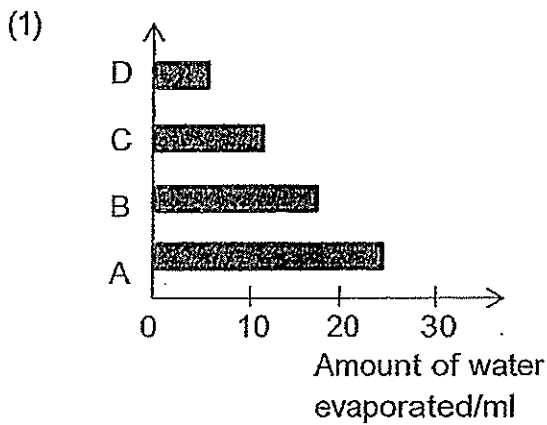

11. Which of the following are causes of water pollution?

- A: Oil spills in ocean
- B: Burning of trees to clear land
- C: Spilling of chemicals from factories into drains
- D: Use of pesticides to kill pests in a nearby plantation

- (1) A and C only
- (2) B, C and D only
- (3) A, C and D only
- (4) A, B, C and D

12. Jared wanted to study the factors that affect the rate of evaporation. He used two of the set-ups as shown in the table below to conduct some investigations.

| Set-Up | Material of container | Exposed surface area /cm ² | Original amount of water /ml | Temperature of water at the start / °C |
|--------|-----------------------|---------------------------------------|------------------------------|--|
| P | Plastic | 200 | 500 | 50 |
| Q | Glass | 200 | 250 | 50 |
| R | Plastic | 400 | 500 | 50 |
| S | Glass | 200 | 250 | 70 |

Which are the possible aims of his investigation?

- A: To find out if the material of container affects the rate of evaporation
- B: To find out if the exposed surface area affects the rate of evaporation
- C: To find out if the temperature of the water affects the rate of evaporation

- (1) A and B only
- (2) A and C only
- (3) B and C only
- (4) A, B and C

13. The diagram below shows four identical beakers W, X, Y and Z covered with a metal lid each filled with water at different temperatures. They were then left in the kitchen.

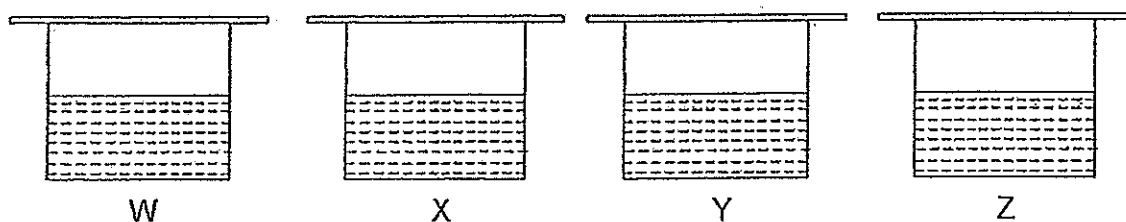

After 20 minutes, the following observations were seen on the surfaces outside the beakers and on their lids.

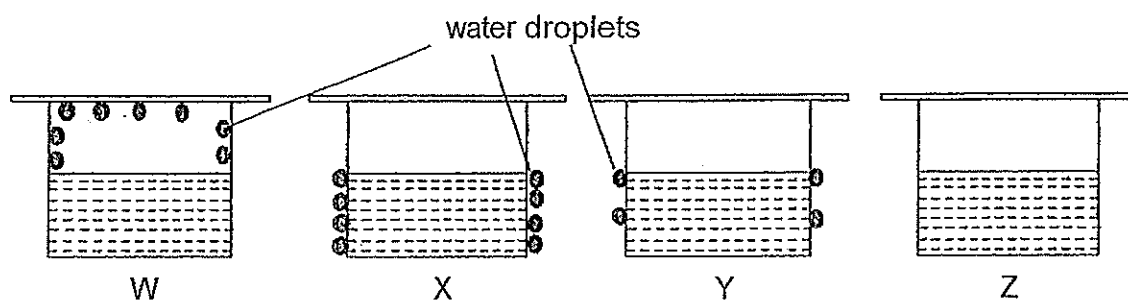

Based on the observations above, which of the following statements are true?

- A: Beaker X and Y contain warm water.
- B: Water in beaker Z is at room temperature.
- C: Water vapour from the surrounding air loses heat to form water droplets inside beaker W.
- D: Water vapour from the surrounding air loses heat to form water droplets outside beaker X and Y.

- (1) A and B only
- (3) A and C only

- (2) B and D only
- (4) A, B and D only

14. The diagram below shows the life cycle of a butterfly.

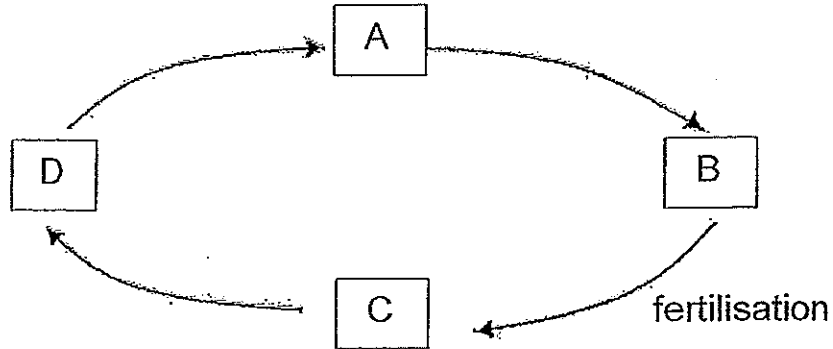

Which one of the following correctly shows the different stages of its life cycle?

| | A | B | C | D |
|-----|-------|-------|-------|-------|
| (1) | Larva | Egg | Pupa | Adult |
| (2) | Larva | Adult | Egg | Pupa |
| (3) | Pupa | Egg | Adult | Larva |
| (4) | Pupa | Adult | Egg | Larva |

15. A ball of plasticine was removed from a beaker of water and remoulded to form 3 similar balls as shown below. The balls were then carefully lowered into the same beaker of water. (Assume that there is no loss of water during the transfer)

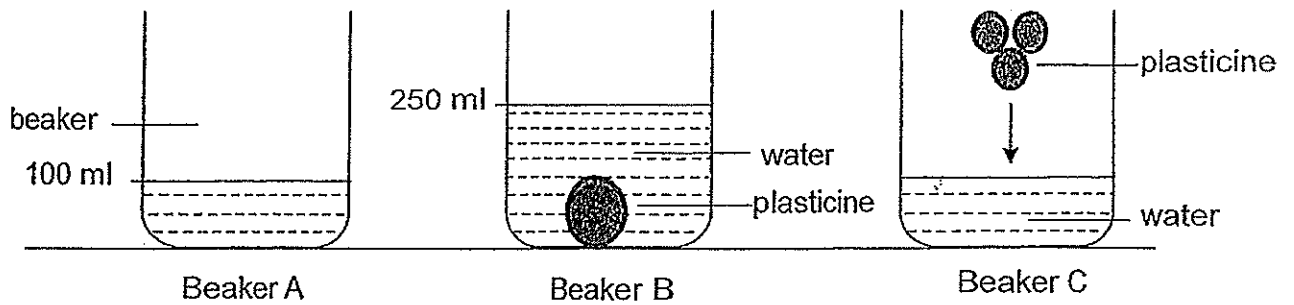

What is the volume in beaker C when the 3 similar balls are lowered?

- (1) 200 ml
(2) 230 ml
(3) 250 ml
(4) 300 ml

Part II (20 marks)

For questions 16 to 23, write your answers in this booklet.

16. The diagram below shows an egg surrounded by sperms in the human reproductive system.

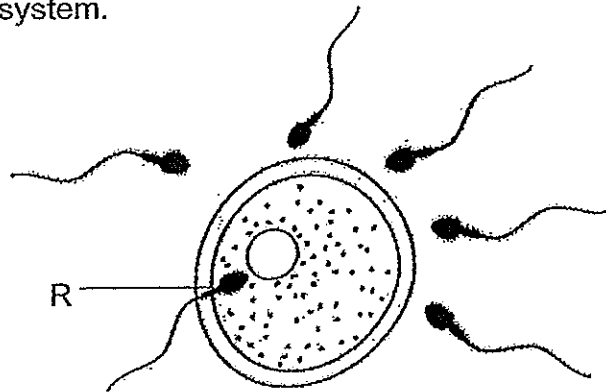

- (a) Name the process that took place when sperm R entered the egg. (1m)

- (b) Why must there be so many sperms released inside the female body? (1m)

17. Diagrams 1 and 2 below show the reproductive systems of a plant and a human respectively.

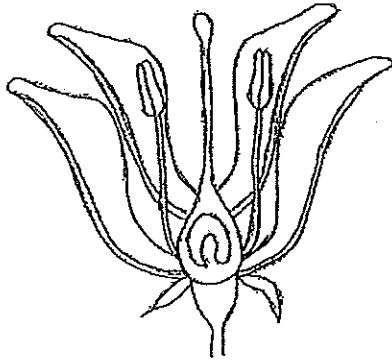

Diagram 1

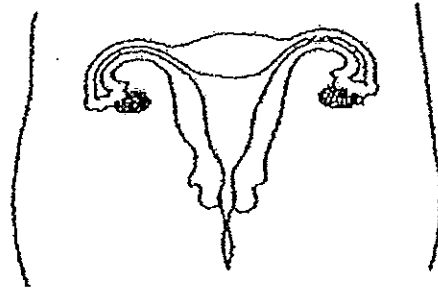
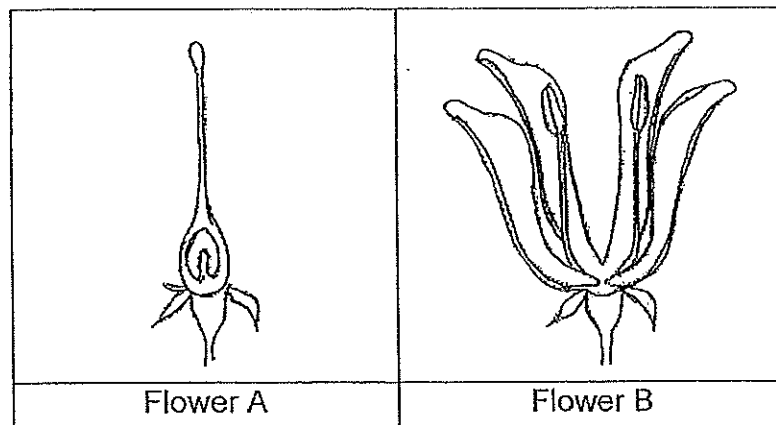

Diagram 2

- (a) Based on the diagrams, state one similarity between the reproductive systems of the plant and the human. (1m)

- (b) In an experiment, two similar flowers, A and B, from a growing plant were used. The different parts from each of these flowers were removed as shown in the diagram below.



Some pollen grains from the same type of flower were then dusted over the flowers.

- (i) In which flower, A or B, would the formation of fruits occur? Give a reason for your answer. (1m)

- (ii) There are two known methods of pollination namely insect pollination and wind pollination. Recently, farmers are starting to practise mechanical pollination where pollen is sprayed in large amount from an aircraft to the fields.

Suggest how can mechanical pollination help farmers? (1m)

18. Jerry heated some ice cubes in a beaker using a heating plate. He recorded the changes in temperature over a period of time as shown in the graph below.

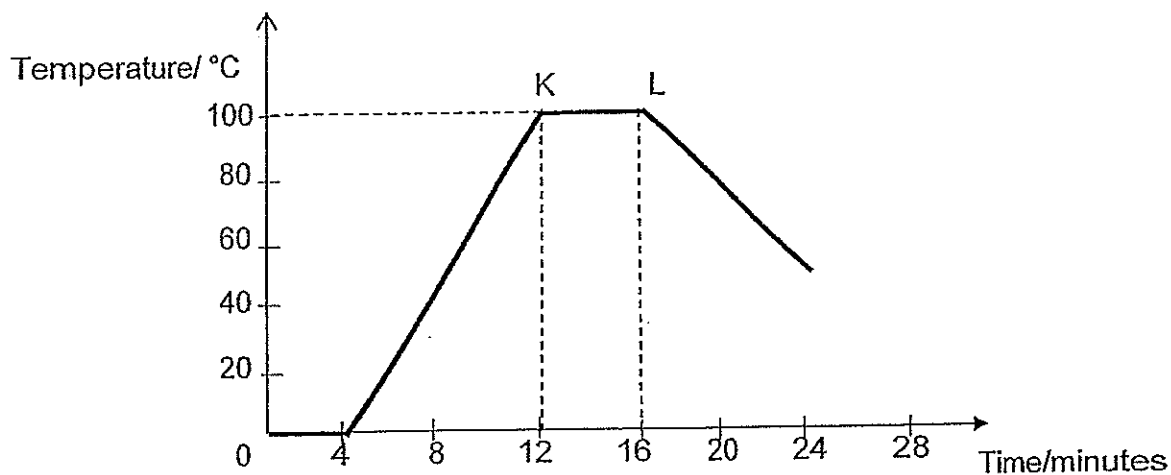

- (a) State what happened between K and L (1m)

- (b) Suggest two ways to heat up the beaker of ice cubes faster. (1m)

19. Four identical containers P, Q, R and S were each filled with an equal volume of water. They were left in four locations with different conditions over a period of four hours as shown in the table below.

| Container | Temperature/ °C | Wind speed/km/h |
|-----------|-----------------|-----------------|
| P | 30 | 25 |
| Q | 30 | 10 |
| R | 70 | 10 |
| S | 70 | 30 |

After four hours, the amount of water left in each container is measured. The result is shown in the graph below.

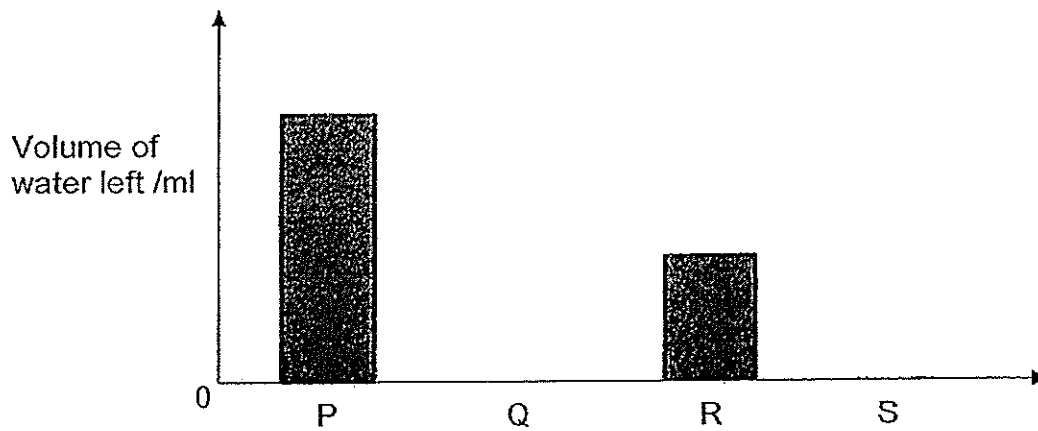

- (a) Draw the missing bar graphs to show the volume of water left in Q and S after 4 hours in the chart above. (1m)
- (b) What is the relationship between the speed of wind and the volume of water left in the containers? (1m)

- (c) Explain the above relationship. (1m)

20. A group of scouts went camping at a beach and was tasked to obtain drinking water from sea water. They dug a hole in the ground and lined it with a plastic sheet. They collected some sea water and poured it into the hole. An empty cup was placed in the middle and another plastic sheet was used to cover the hole. They also placed rocks at the two sides and a pebble was placed as shown below.

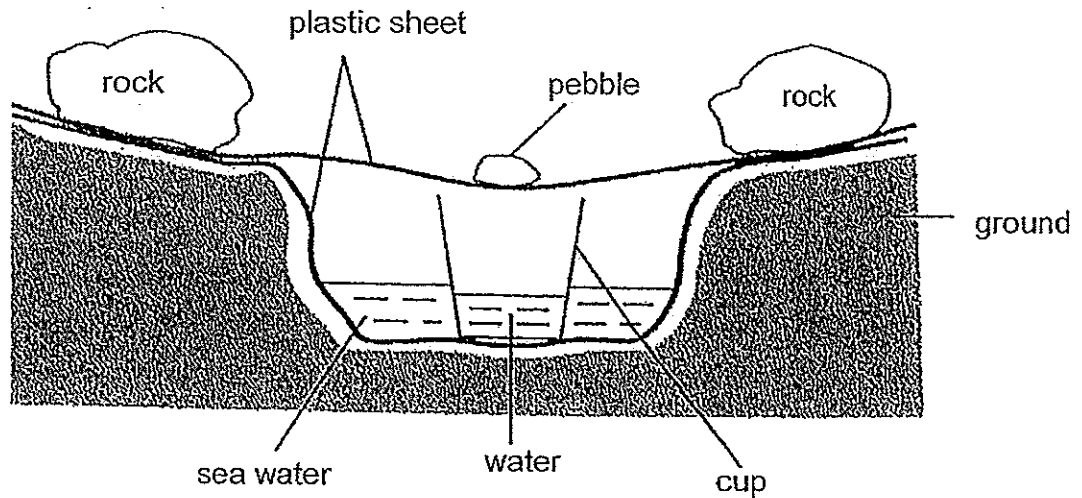

- (a) After a few hours, water was found in the cup. Describe how water was obtained. (2m)

- (b) What would be observed if the pebble on the plastic sheet in (a) was replaced with a few ice cubes? (1m)

Another group of scouts did a similar task with the same amount of sea water in the hole. Instead of using a cup, they used a large bowl to collect the water.

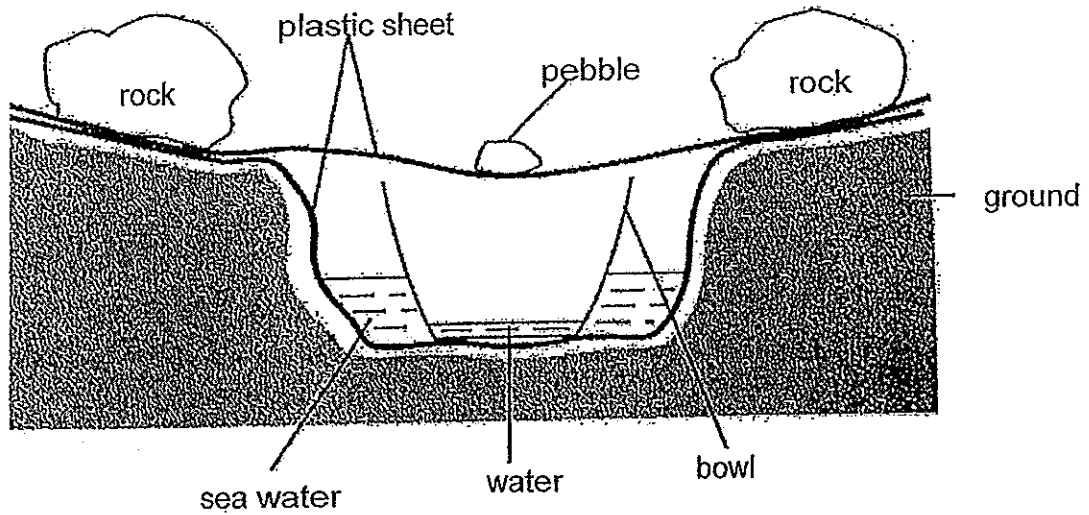

- (c) After a few hours, they found that less water was collected in the bowl. Explain why it had happened. (1m)

21. The table below shows how an insect's body length changes after each moult.

| Number of moults | Body Length (cm) |
|------------------|------------------|
| 1 | 2 |
| 2 | 3 |
| 3 | 4 |

(a) What do you think would happen to the mass of the insect as the number of moults increases? (1m)

(b) Why do the young of insects need to moult? (1m)

22. A measuring cylinder was packed with small stones to the 50 ml mark. 50 ml of water was then added but the water level did not reach the 100 ml mark as shown below.

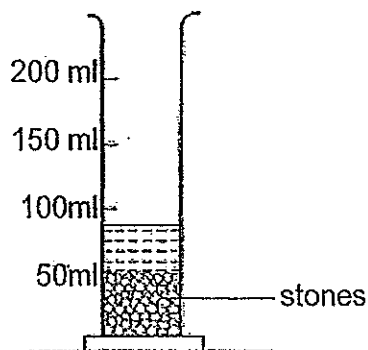

- (a) Explain why the water level did not reach the 100 ml mark. (1m)

In another investigation, two set-ups A and B, were used as shown below.

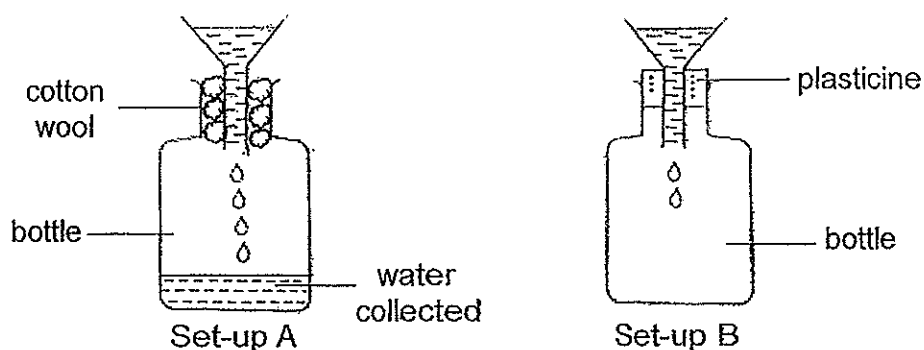

It was observed that the water flows into the bottle easily in set-up A but only a few drops of water entered the bottle in set-up B.

- (b) Explain the difference in the observations for set-ups A and B. (1m)

23. Tom hung a thin rod made of materials X and Y. Two identical glass beads were attached to the ends of the rod by the same amount of wax as shown in the diagram below.

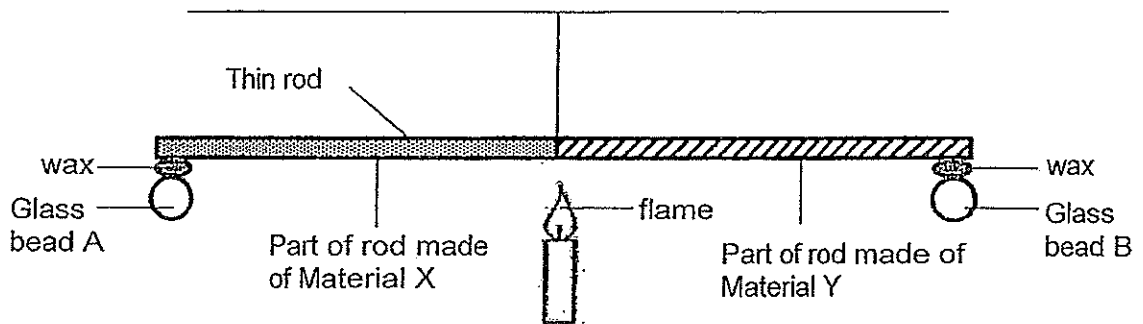

After a few minutes, Tom observed that glass bead B dropped.

- (a) Explain what caused glass bead B to drop. (1m)

- (b) Which material, X or Y, should Tom use to make a container to keep food warm for a longer period of time? Give a reason for your answer. (1m)

End of Paper

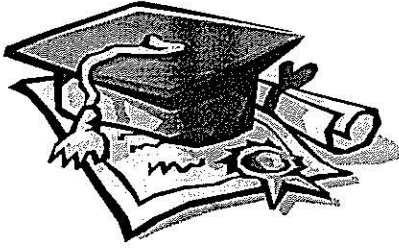

ANSWER SHEET

EXAM PAPER 2014
SCHOOL : ROSYTH
PRIMARY : P5
SUBJECT : SCIENCE
TERM : CA2

| Q1 | Q2 | Q3 | Q4 | Q5 | Q6 | Q7 | Q8 | Q9 | Q10 | Q11 | Q12 | Q13 | Q14 | Q15 |
|----|----|----|----|----|----|----|----|----|-----|-----|-----|-----|-----|-----|
| 1 | 1 | 4 | 2 | 1 | 4 | 2 | 4 | 2 | 2 | 4 | 3 | 2 | 4 | 3 |

16)a)Fertilisation

b)It increases the chance of the male sperm cell fertilizing with the female egg cell.

17)a)Both have female parts.

b)i)It has ovary for fertilization to take place.

ii)It helps speed up fertilization.

18)a)The ice cubes had melted and reached boiling point.

b)1)Increase the heat source.

2)pour hot water over the ice cubes.

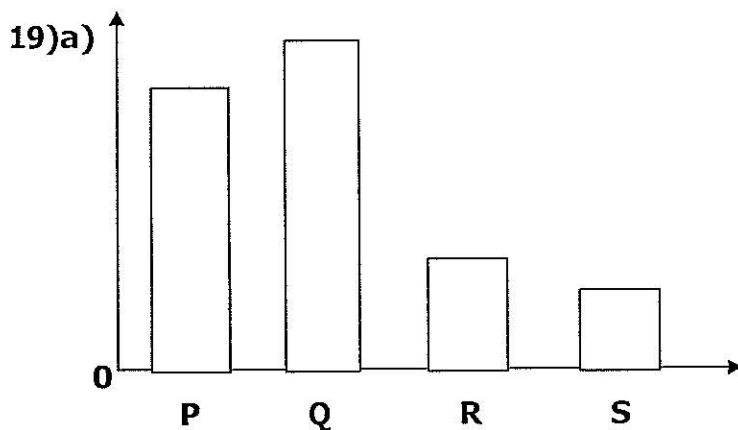

19)b)The faster the speed of the wind is the lesser amount of water left in the containers.

c)The greater the speed of wind, the faster the rate of evaporation.

20)a)The sea water evaporated onto the plastic sheet as water vapour, condenses with the cold plastic sheet turns to water droplets, and slides down to where the cup is collects more water and eventually drop into the cup as clear water.

b)A larger amount of water will be observed.

c)The seawater has a smaller exposed surface area to evaporate and less water was collected.

21)a)The mass of the insect will increase.

b)They moult to enable the body to grow.

22)a)There were small gaps in the stones and the water, took up the space in it, which is why it did not reach the 100ml mark.

b)Cotton wool allows the air to escape but the plasticine did not allow air to escape.

23)a)Heat traveled from the flame through the rod and made the wax melt.

b)X. X is a poorer conductor of heat and can keep the food warm for a longer period of time.