

Name: _____ ()

Class: Primary 5 _____

CHIJ ST NICHOLAS GIRLS' SCHOOL

Primary 5
Semestral Assessment 1 – 2016
SCIENCE
BOOKLET A
12 May 2016

Total Time for Booklets A and B: 1 hour 45 minutes

28 questions
56 marks

Do not open this booklet until you are told to do so.
Follow all instructions carefully.
Answer all questions.

This booklet consists of 20 printed pages.

Section A (28 x 2 marks = 56 marks)

For each question from 1 to 28, four options are given. One of them is the correct answer. Make your choice (1, 2, 3 or 4). Shade the correct oval (1, 2, 3 or 4) on the Optical Answer Sheet provided.

1. Which of the following about the human digestive system is correct?

	Organ involved in the digestion of food	Organ involved in the absorption of food
(1)	large intestine	small intestine
(2)	mouth	large intestine
(3)	small intestine	gullet
(4)	stomach	small intestine

2. Which of the following characteristics can be used to show the similarity between a crocodile and a salamander?

- (1) Both have scales.
- (2) Both live on land only.
- (3) Both reproduce by laying eggs.
- (4) Both breathe through lungs only.

3. The diagram below shows the different stages in the growth of a seedling.

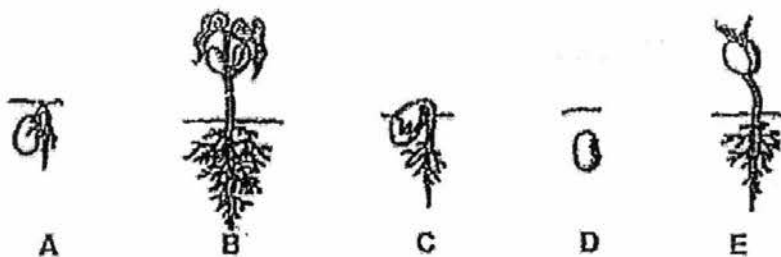

At which stage(s) does the seedling need light to survive?

- (1) Stage B only
- (2) Stage E only
- (3) Stage A, B and C only
- (4) Stage B, E and C only

4. Amelia observed four animals as shown below.

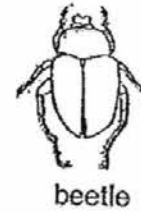
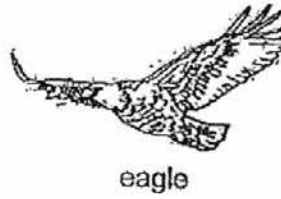
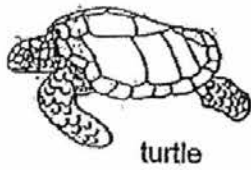

She classified them in the flowchart below.

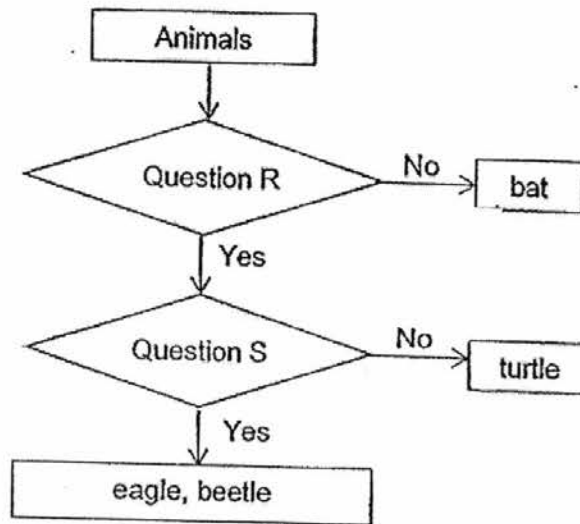

Which of the following best represents the two questions, R and S, in the flow chart?

	Question R	Question S
(1)	Can they fly?	Do they have wings?
(2)	Do they have wings?	Do they feed their young with milk?
(3)	Do they feed their young with milk?	Do they lay eggs?
(4)	Do they lay eggs?	Can they fly?

5. Amy thought of three possible setups to keep a grasshopper in a glass container as a pet.

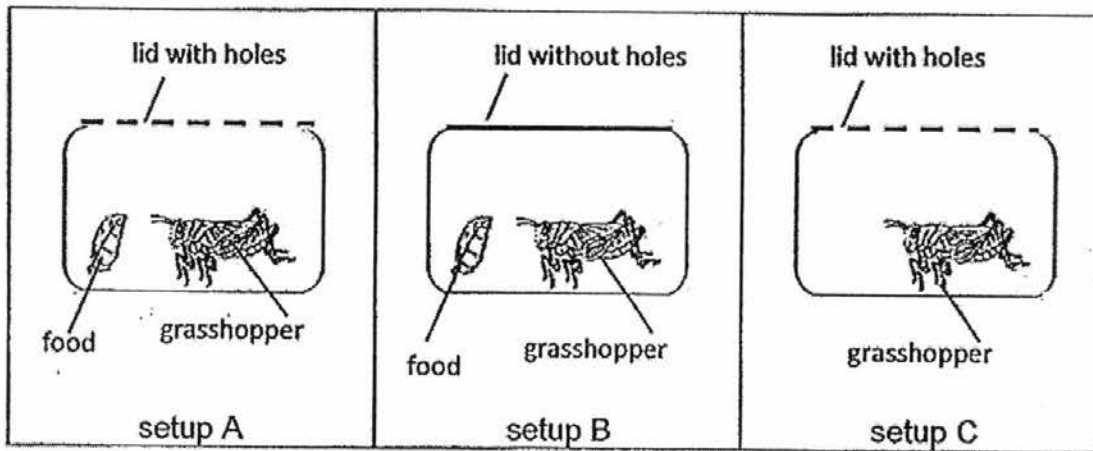

Which one of the following is correct?

	Least suitable way to keep the grasshopper	Most suitable way to keep the grasshopper
(1)	A	B
(2)	A	C
(3)	B	A
(4)	B	C

6. Which of the following is not part of the human circulatory system?

- A : Red blood cells
- B : Lungs
- C : Heart
- D : Blood vessels
- E : Windpipe

- (1) A and E only
- (2) B and E only
- (3) A, C and D only
- (4) A, B, C and D only

7. The diagram below shows the gaseous exchange between the surface of an air sac and the blood vessel of a human.

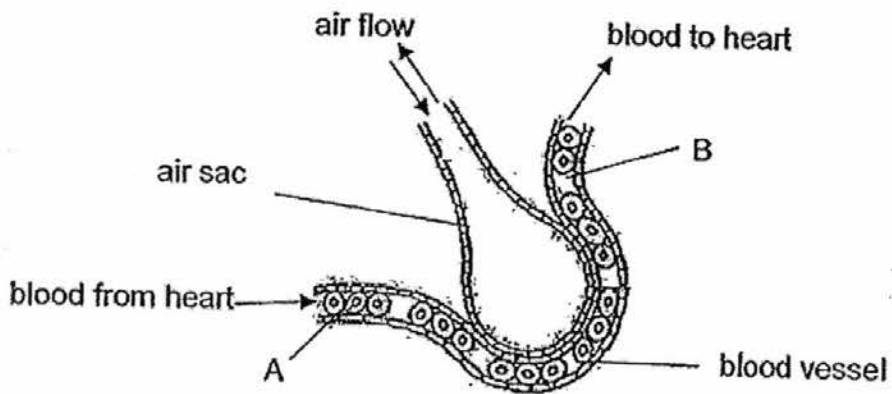

Which of the following correctly represents the level of oxygen and carbon dioxide respectively in A and B?

	A		B	
	oxygen	carbon dioxide	oxygen	carbon dioxide
(1)	high	high	low	low
(2)	low	low	high	high
(3)	high	low	low	high
(4)	low	high	high	low

8. Which of the following correctly shows the path of the air when we breathe out?

- (1) Nose → windpipe → lungs
 (2) Nose → windpipe → mouth
 (3) Lungs → mouth → nose
 (4) Lungs → windpipe → nose

9. The diagram below shows a plant cell taken from a leaf.

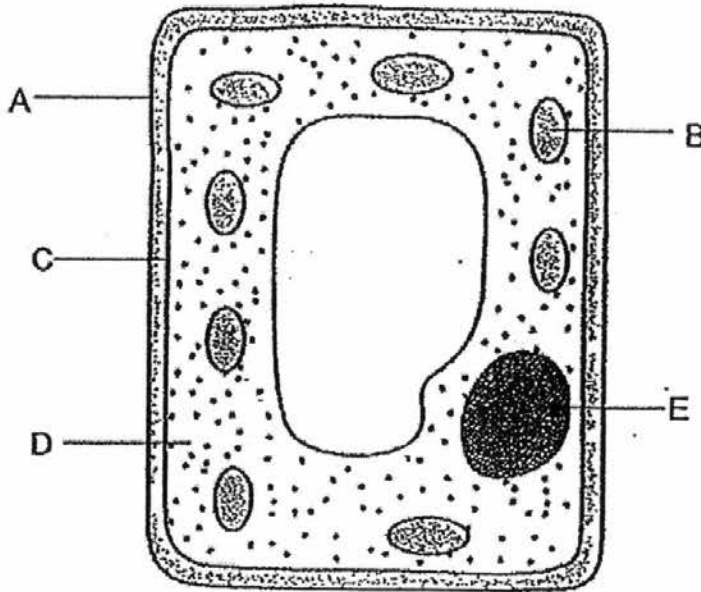

Which three parts are also found in cheek cells?

- (1) A, B and E
- (2) A, D and E
- (3) B, C and D
- (4) C, D and E

10. The diagram below shows a stem with its outer ring removed. After some time, the stem was swollen at point A.

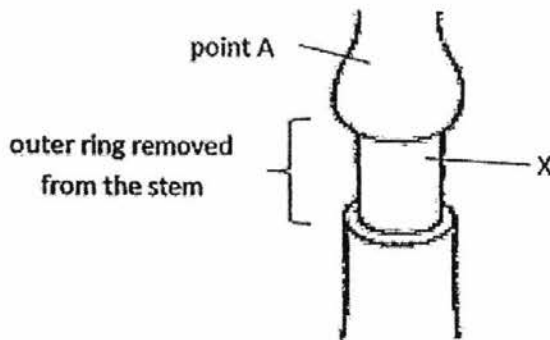

What is transported in the part labelled X?

- (1) food only
- (2) water only
- (3) food and water
- (4) water and mineral salts

11. The diagram below shows the movement of substances in a plant.

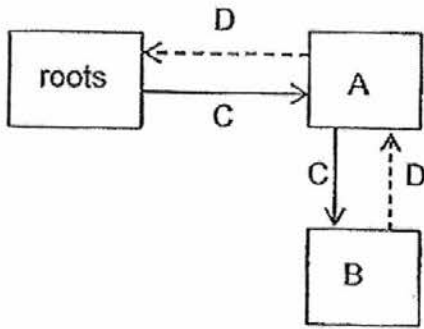

Which of the following correctly represents, A, B, C and D?

	A	B	C	D
(1)	leaf	stem	water	food
(2)	leaf	flower	food	water
(3)	stem	leaf	water	food
(4)	flower	stem	food	water

12. Tom and Jerry were trapped in a small lift. They remained still for about 30 minutes while waiting for help to arrive.

Which of the following correctly shows the changes in the amount of gases in the lift after 30 minutes?

	Oxygen	Carbon dioxide	Water vapour
(1)	increase	decrease	decrease
(2)	decrease	increase	increase
(3)	increase	decrease	remain the same
(4)	decrease	increase	remain the same

13. The graph below shows the number of breaths per minute taken by a cat over a period of time.

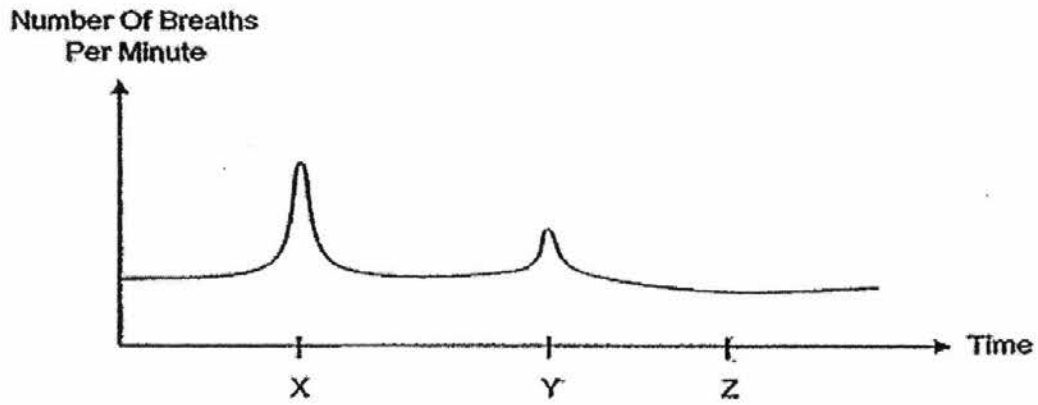

Which of the following correctly states the cat's activities at X, Y and Z?

	X	Y	Z
(1)	sleeping	walking around	chasing a mouse
(2)	chasing a mouse	sleeping	walking around
(3)	chasing a mouse	walking around	sleeping
(4)	walking around	chasing a mouse	sleeping

14. When the setup below was left overnight, the mixture inside the bag turned dark blue.

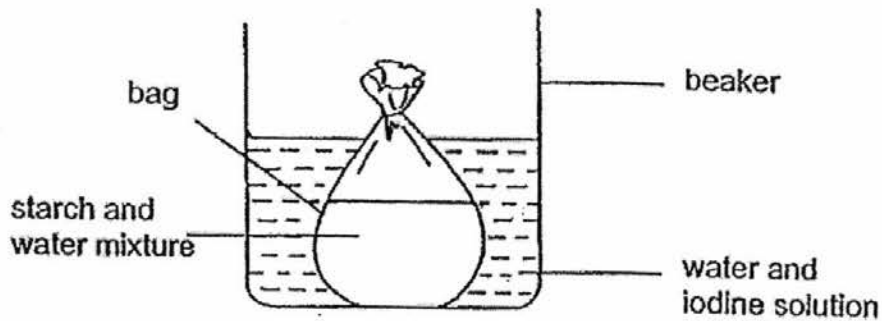

Which of the following shows the correct comparison between the parts of the setup and parts of a cell?

	Parts of the setup	Parts of a cell
(1)	Bag	Cell membrane
(2)	Beaker	Cell membrane
(3)	Starch and water mixture	Nucleus
(4)	Water and iodine solution	Cytoplasm

15. Wei Ming drew a diagram as shown below. The arrows indicate the direction of blood flow in the same blood vessel when his arm is lowered then raised.

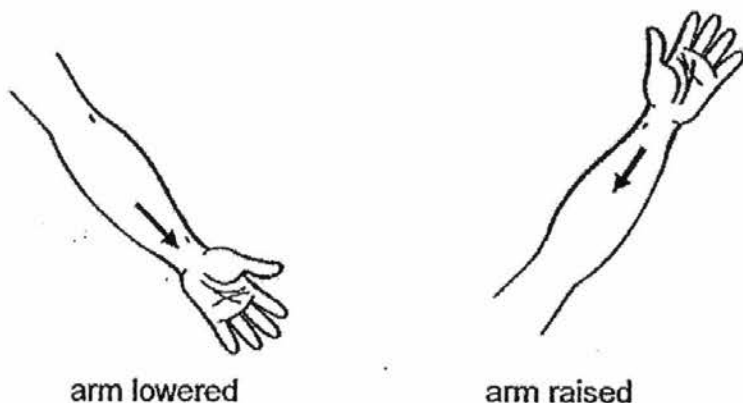

Wei Ming's teacher told him that his diagram was incorrect because _____.

- (1) blood should stop flowing when the arm was raised
- (2) the direction of blood flow in all blood vessels should always be towards the heart
- (3) the direction of blood flow in all blood vessels should always be away from the heart
- (4) the direction of blood flow in a particular blood vessel should not change when the position of the arm changes

16. John classified three types of cells as shown below.

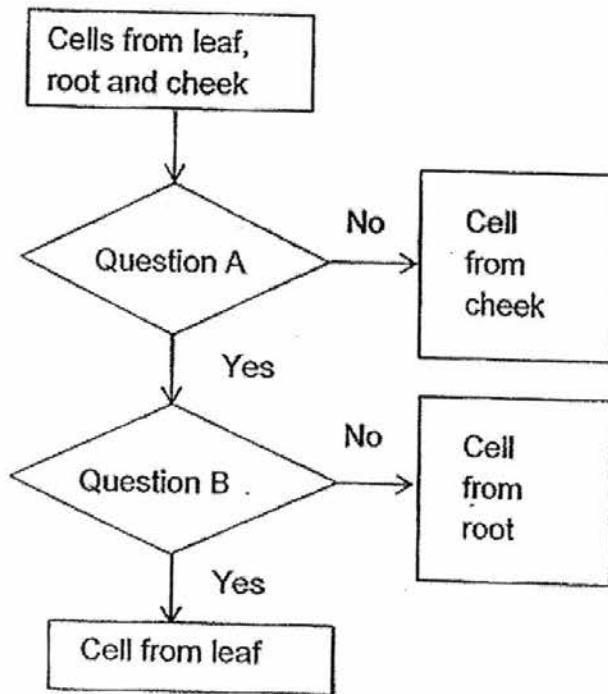

What are questions A and B?

	Question A	Question B
(1)	Does the cell have chloroplast?	Does the cell have a cell wall?
(2)	Does the cell have a cell wall?	Does the cell have chloroplast?
(3)	Does the cell have a nucleus?	Does the cell have a cell membrane?
(4)	Does the cell have a cell wall?	Does the cell have a nucleus?

17. Eileen placed 3 strips, Q, R and S, made of different materials into 3 beakers each containing 50ml of blue-coloured water. She left the strips in the beakers for 10 minutes and observed that there were different watermarks on each strip as shown in the diagram below.

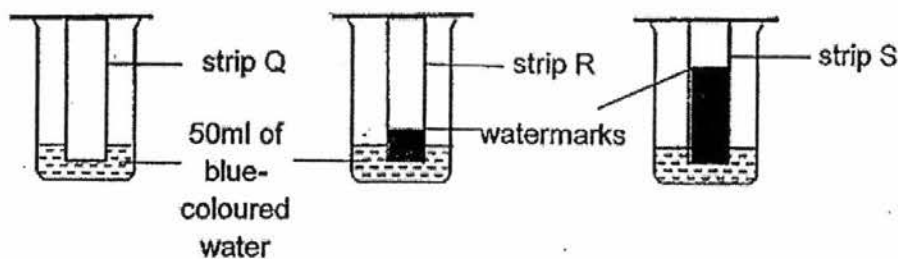

Based on her observations, Eileen wrote the following statements.

- A Strip Q is waterproof.
- B Strip R absorbed more water than strip S.
- C Strip S is the most water absorbent material.
- D None of the materials is suitable to be used to make hand towels.

Which of the statements above are correct?

- (1) A and C only
 - (2) B and D only
 - (3) A, B and C only
 - (4) A, B, C and D
18. Sharon set up an experiment to investigate the transparency of three different materials, X, Y and Z, using a data logger and a light sensor.

Which of the following variables should she keep constant in order to conduct a fair test?

- A Type of materials
 - B Brightness of the torch
 - C Thickness of materials used
 - D Distance between the torch and the materials
 - E Distance between the light sensor and the materials
- (1) A, C and D only
 - (2) C, D and E only
 - (3) A, B, C and D only
 - (4) B, C, D and E only

19. Hayley inserted a glass tube into an empty plastic bag and fastened them with a rubber band as shown in the diagram below.

She marked the water level on the container. She then blew air through the glass tube into the plastic bag.

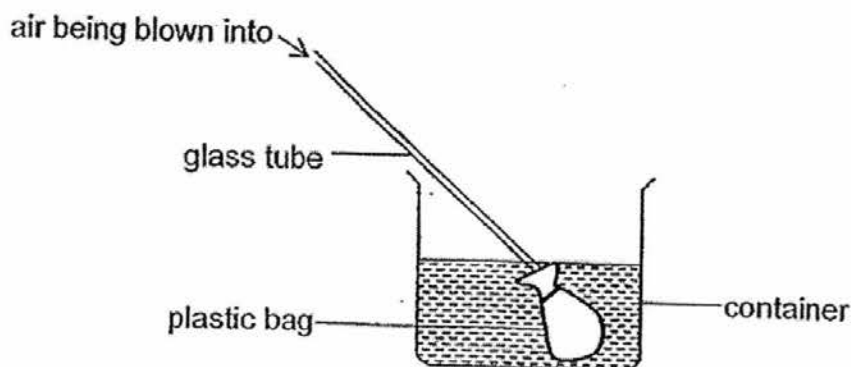

Which one of the following would be Hayley's observation when she blew air into the glass tube?

- (1) The volume of water will increase.
- (2) The water level in the container will drop as water would enter the plastic bag.
- (3) The air in the plastic bag would occupy less space and caused the water level in the container to decrease.
- (4) The air in the plastic bag would occupy more space and caused the water level in the container to increase.

20. Study the diagram below. An experiment was set up using a sealed metal container which holds 80cm^3 of water and 40cm^3 of air. 20cm^3 of water was removed from the container through tap Q and 50cm^3 of air was then pumped in through pump R.

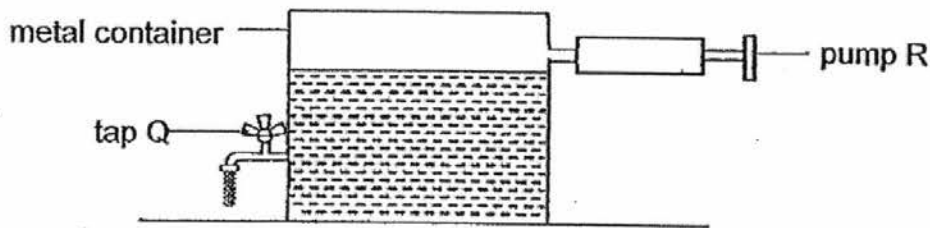

What would be the final volume of air in the container?

- (1) 50cm^3
 - (2) 60cm^3
 - (3) 90cm^3
 - (4) 110cm^3
21. Sulimah attached a coin to each of the four bars, A, B, C and D, using some wax. The diagram below shows the top view of the setup.

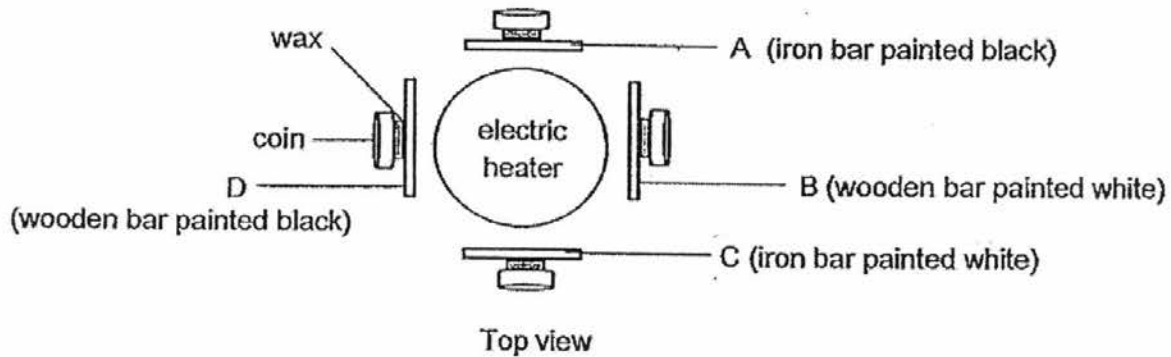

From which bar, A, B, C or D, will the coin drop first?

- (1) A
- (2) B
- (3) C
- (4) D

22 The setup below shows light shining on three shapes, A, B and C, made of wood. They are placed at different distances from the torch.

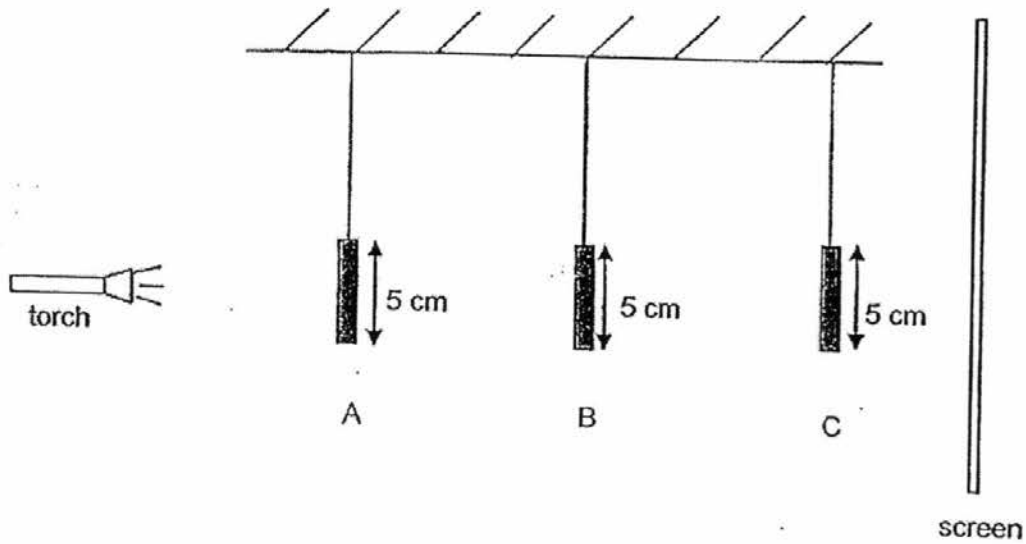

The diagram below shows what was seen on the screen.

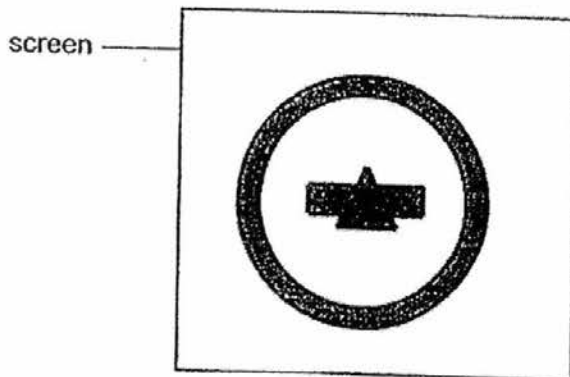

Which one of the following correctly represents shapes, A, B and C, respectively?

	A	B	C
(1)	ring	rectangle	triangle
(2)	ring	triangle	rectangle
(3)	rectangle	triangle	ring
(4)	rectangle	ring	triangle

23. Two beakers, E and F, contained 200ml and 500ml of water at 100°C respectively. Both beakers were left on a table in an air conditioned room of temperature 20°C .

Which of the following line graphs best represents the changes in the temperature of water in both beakers?

(1) Temperature ($^{\circ}\text{C}$)

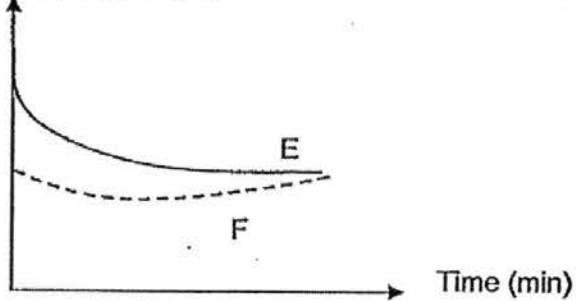

(2) Temperature ($^{\circ}\text{C}$)

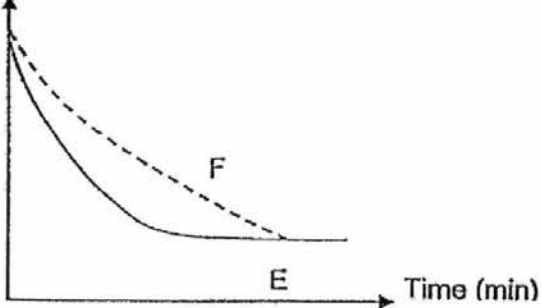

(3) Temperature ($^{\circ}\text{C}$)

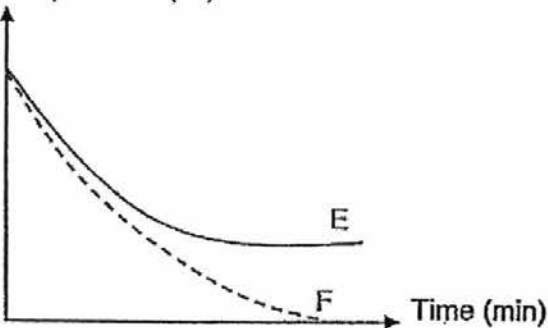

(4) Temperature ($^{\circ}\text{C}$)

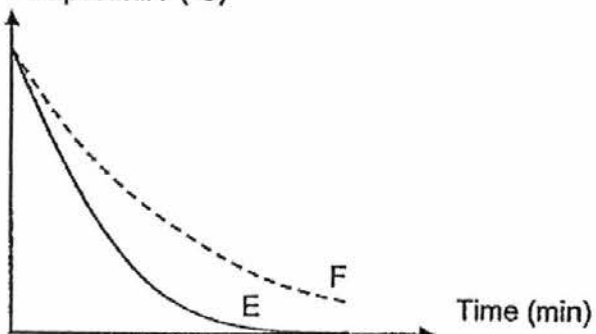

24. Ainul arranged three magnets, EF, GH, JK, and a steel bar PQ as shown below.

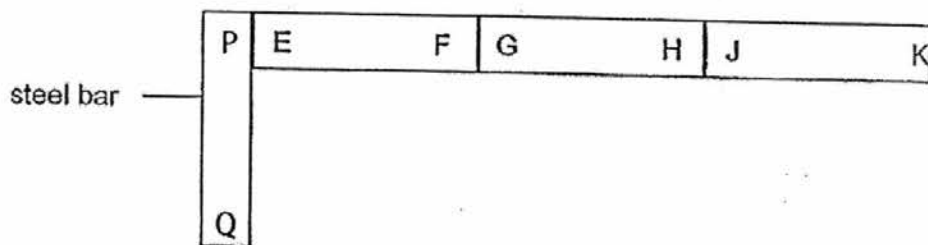

She then tried to rearrange the magnets and the steel bar.

Which one of the following arrangements is possible?

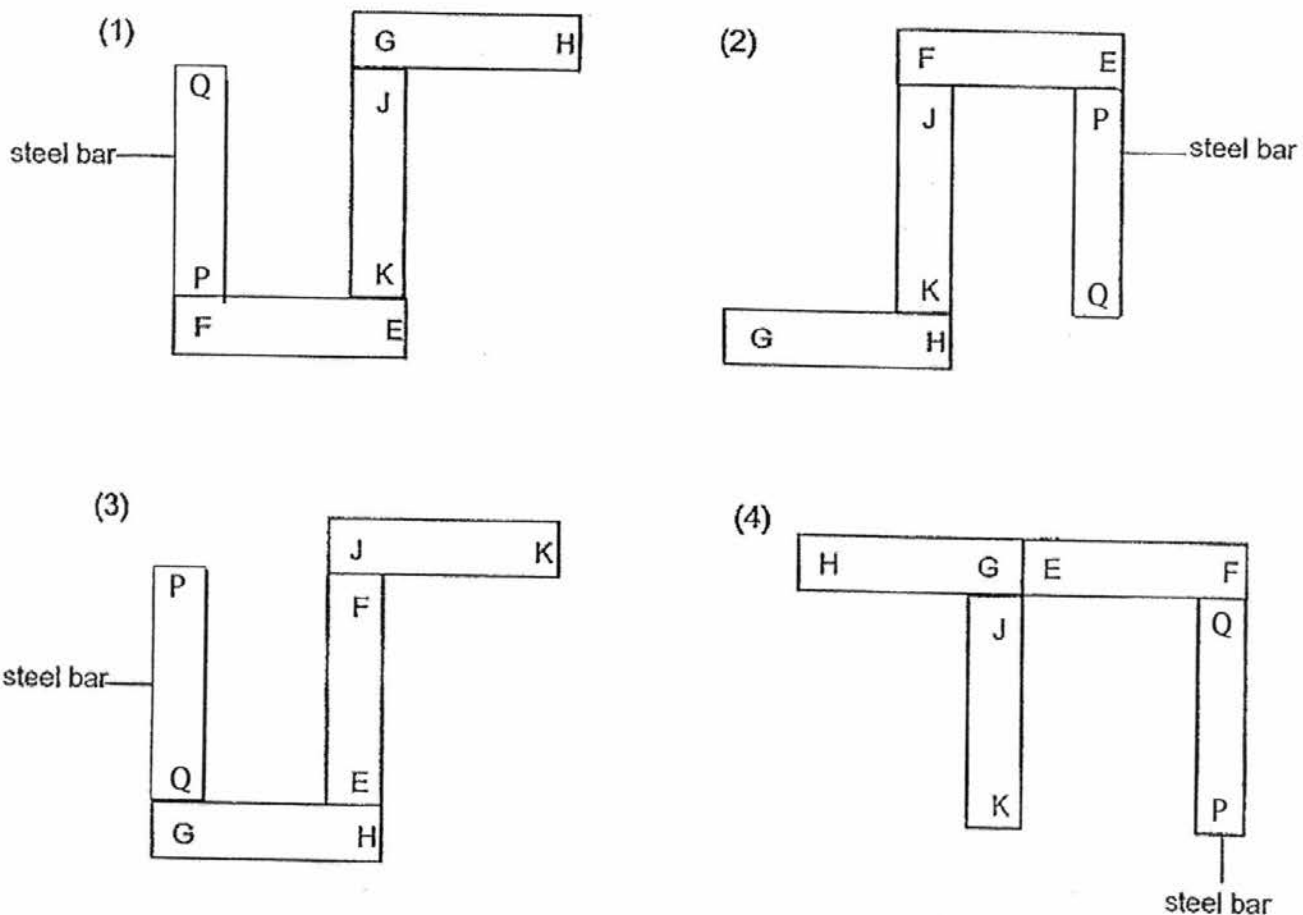

25. Priscilla hung a paper spiral above a candle as shown in the diagram below.

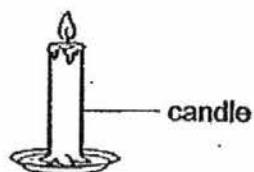
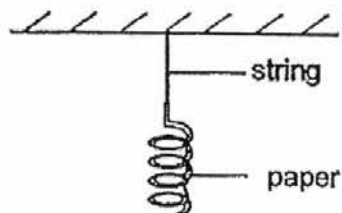

After some time, Priscilla made an observation about the paper spiral.

Which of the following is correct?

	Observation	Explanation
(1)	It will not spin.	The heat from the candle is lost to the surrounding.
(2)	It will be burnt.	The heat from the candle will be transferred to the paper spiral and it caught fire.
(3)	It will spin slowly.	The heat from the candle will heat up the surrounding air and the moving air will cause the paper spiral to spin slowly.
(4)	It will become shorter.	The heat from the candle will allow the paper spiral to contract.

26. The diagram below shows a light bulb.

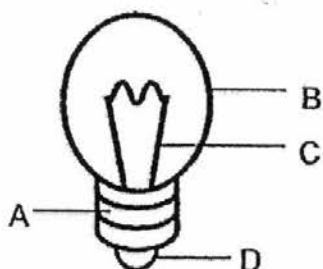

Which of the following part(s) are electrical insulators?

- (1) B only
- (2) C and D only
- (3) D and E only
- (4) B, D and E only

27. Sally set up a circuit as shown in the diagram below.

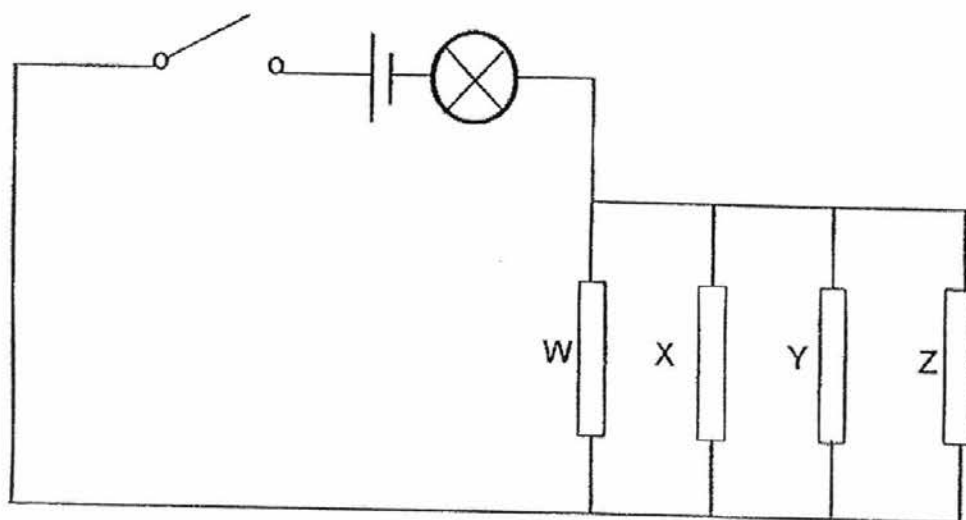

The table below shows the observations she made when the switch is closed.

Object(s) removed from circuit	Did the bulb light up?
W	yes
X and Y	yes
W, X and Y	no
W, Y and Z	no

Based on the observations above, which one of the following conclusions is correct?

	W	X	Y	Z
(1)	conductor	insulator	insulator	insulator
(2)	insulator	conductor	conductor	conductor
(3)	conductor	insulator	conductor	insulator
(4)	insulator	conductor	insulator	conductor

28. Study the electrical circuits below. The circuits have been set up using identical batteries, bulbs and wires.

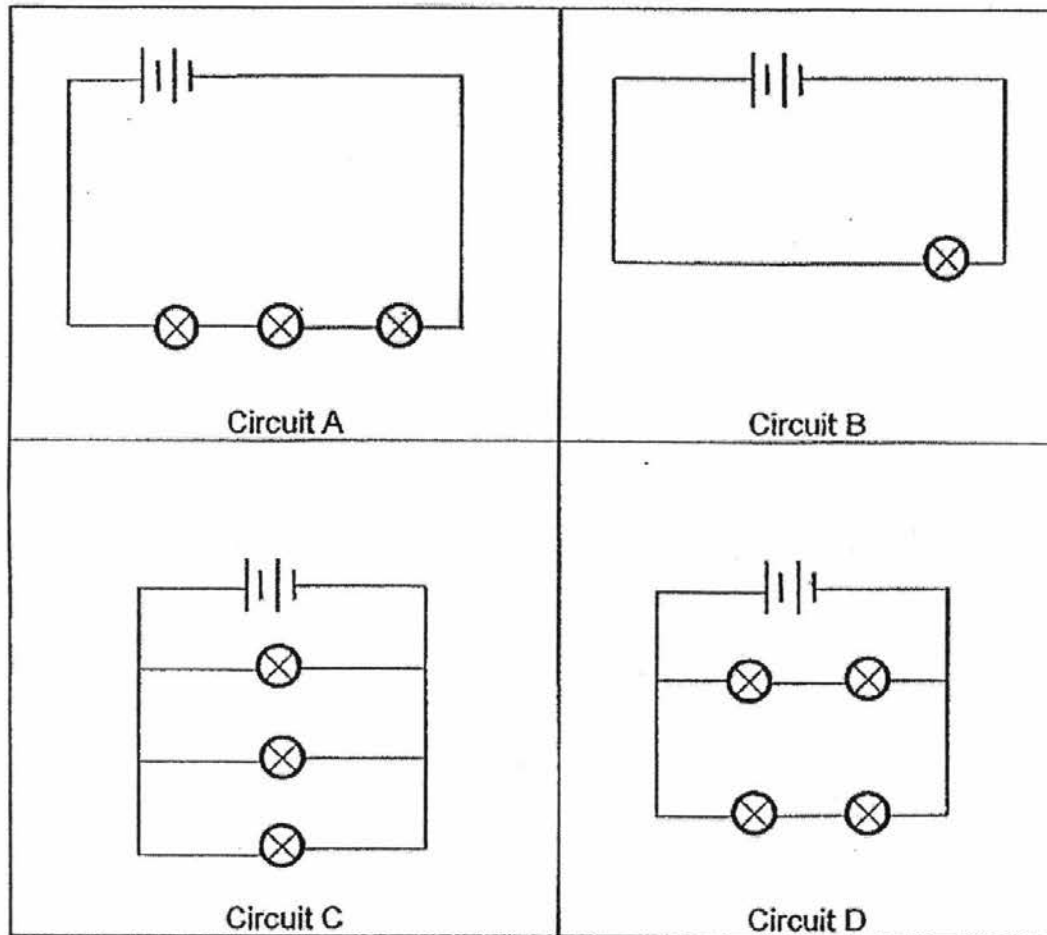

Which 2 of the above circuits will have the same brightness in each bulb?

- (1) Circuit A and C
- (2) Circuit A and D
- (3) Circuit B and C
- (4) Circuit C and D

End of Booklet A

Name : _____ ()

Class : Primary 5 _____

CHIJ ST NICHOLAS GIRLS' SCHOOL



Primary 5
Semestral Assessment 1 – 2016

SCIENCE

BOOKLET B

12 May 2016

Total Time for Booklets A and B: 1 hour 45 minutes

13 questions
44 marks

Do not open this booklet until you are told to do so.
Follow all instructions carefully.
Answer all questions.

This paper consists of 16 printed pages.

Booklet A	56
Booklet B	44
Total	100

Parent's Signature/Date

Section B (44 marks)

For questions 29 to 41, write your answers in this booklet.

The number of marks available is shown in the brackets at the end of each question or part question.

29. Study the classification chart below carefully.

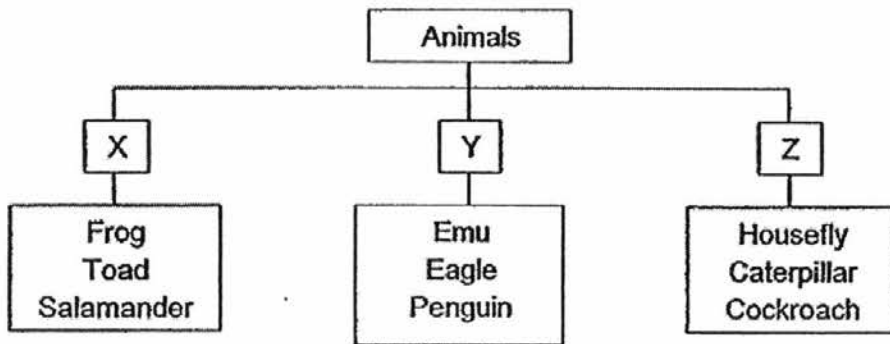

- (a) State one difference between animal X and Y in terms of their body coverings. [1]

The diagram below shows animal Q.



animal Q

- (b) Based on the classification chart, state 2 reasons why animal Q cannot be placed in group Z. [1]

Reason 1: _____

Reason 2: _____

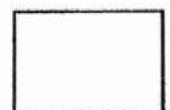

30. The graph below records the duration of the stages in the life cycle of organism X. The stages of the life cycle is not in the correct order.

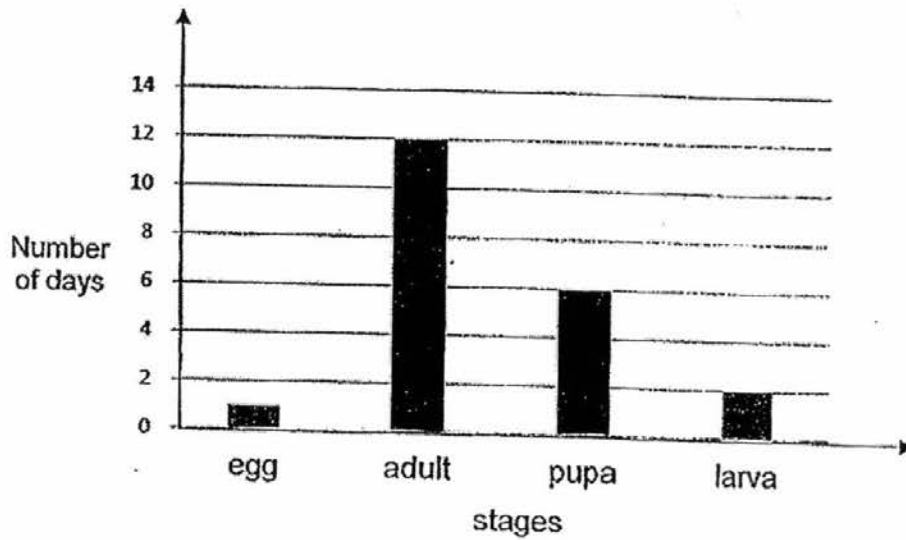

- (a) Write the stages of the life cycle of organism X in the correct order.

[1]

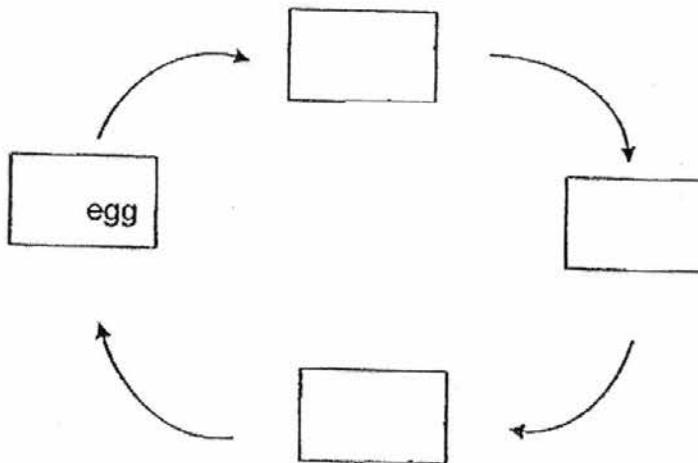

- (b) How many days would organism X take to become an adult after the egg is hatched?

[1]

- (c) Organism X lay many eggs at one time. Give a reason why.

[1]

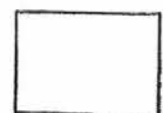

31. The diagram below shows the flow of blood in a fish and a human body.

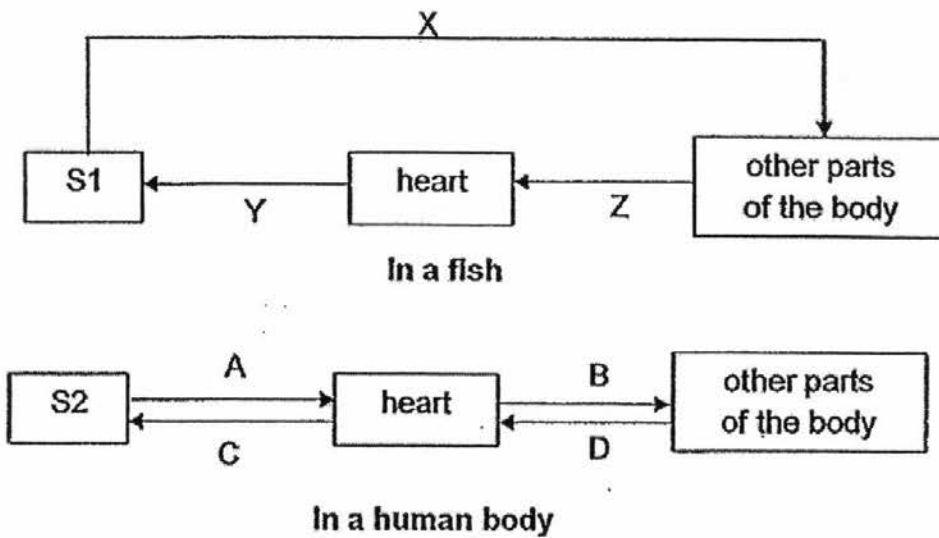

(a) Identify organs, S1 and S2.

[1]

S1 : _____

S2: _____

(b) State one difference between the blood flow found in the circulatory system of a fish and in a human.

[1]

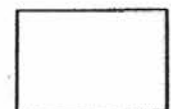

32. Look at the diagram below.

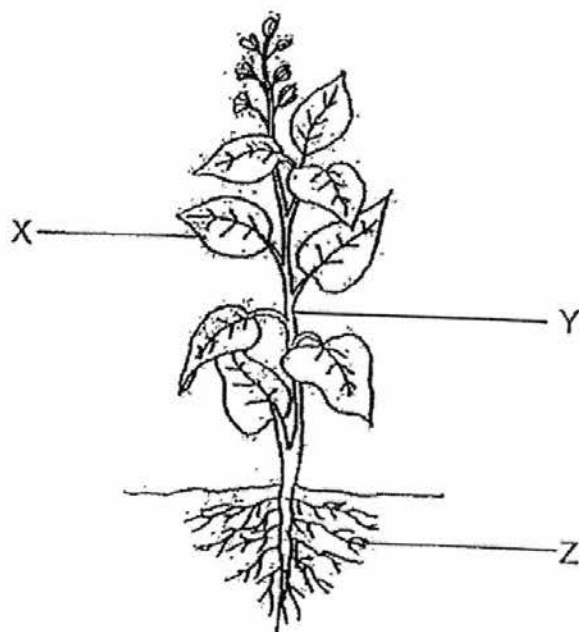

(a) Which part, X, Y or Z, of the plant will the following cells be found? [1]

(i)

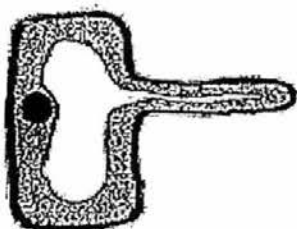

Part: _____

(ii)

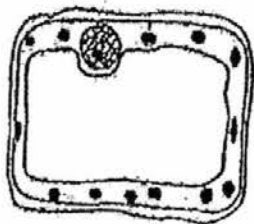

Part: _____

(b) Explain your answer in (a) (i).

[2]

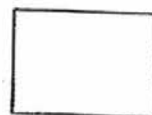

33. Anne conducted an experiment as shown below. Equal amounts of water and oil were added into each container. The setups were placed next to a window in the science lab.

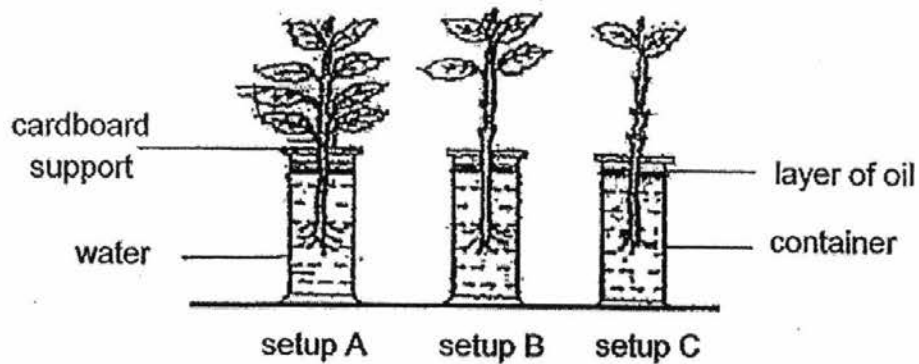

The amount of water left in all the containers were recorded daily over a period of 1 week and the results obtained were plotted in the graph as shown below.

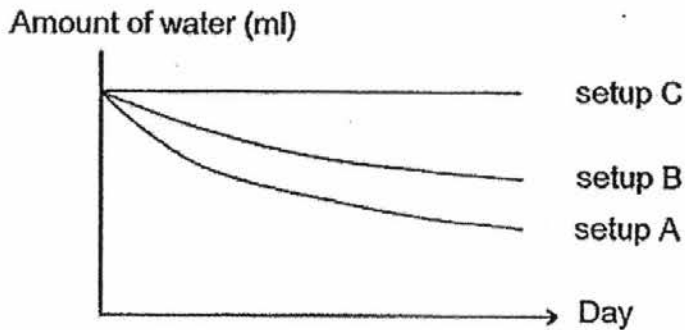

Anne's teacher commented that she had plotted one graph incorrectly.

- (a) Which graph is plotted wrongly? Explain why. [1]

- (b) What conclusion can she make from the results of her experiment? [1]

- (c) Give a reason how each of the following actions helps to make her experiment a fair test. [2]

- (i) using similar containers

- (ii) placing all the three set-ups at the same place

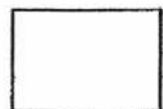

34. Judy conducted an experiment with 3 bags of the same size, C, D and E, made of different materials. Bag C was hung on 2 hooks and some weights were added into the bag. She recorded the maximum weight bag C could hold before it broke. She repeated the experiment with bags, D and E.

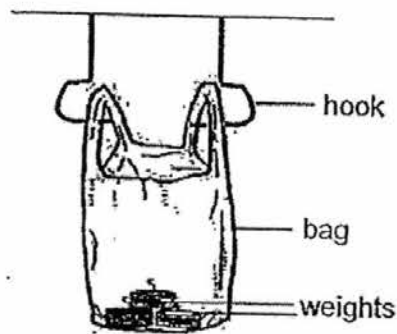

The results are shown below.

Material	Maximum weight each bag can hold (g)
C	1000
D	2500
E	500

- (a) State the property of material that Judy was testing. [1]

- (b) Which of the bags, C, D or E, could Judy use if she wanted to carry a 1.5-litre bottle of coke in it? Give a reason for your answer. [2]

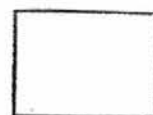

35. The diagram below shows two cups of the same size and made of the same material. The cups are fitted with 2 different cardboard sleeves. Same amount of hot coffee of 90°C were poured into the 2 cups.

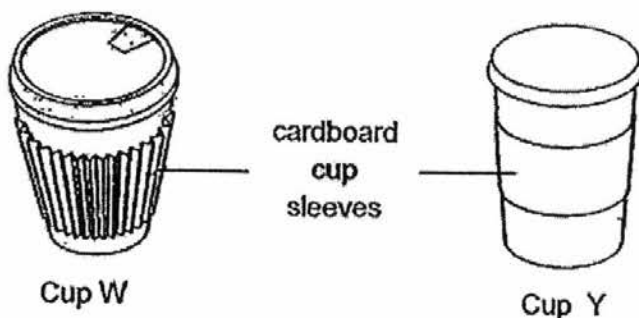

- (a) Which cup, W or Y, could be held for a longer period of time before it became too hot to hold on to? Explain your answer. [2]

- (b) State 2 properties of the cardboard that makes it suitable for making the cup sleeves. [1]

Property 1: _____

Property 2: _____

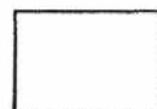

36. An experiment was set up to measure the amount of light that passed through water samples taken from different ponds, W, X, Y and Z.

The bar graph below shows the results.

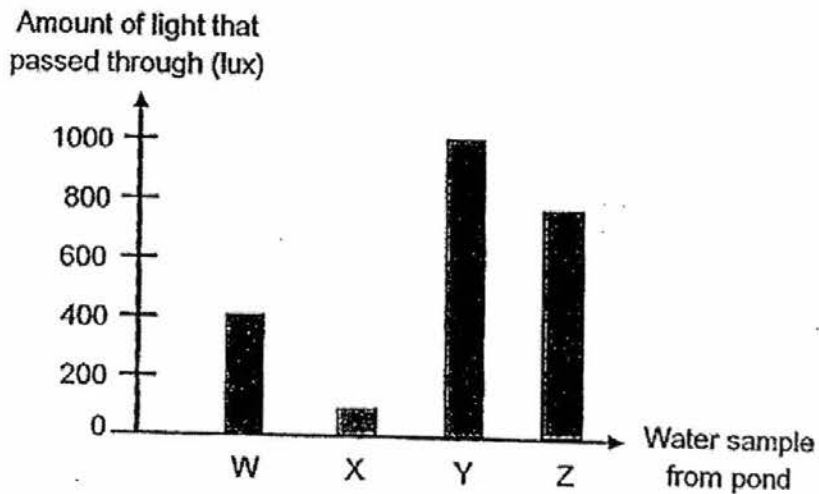

- (a) State one changed variable for this experiment.

[1]

- (b) Plant A is a submerged plant that requires a lot of light for growth. Which pond, W, X, Y or Z, would be most suitable for plant A to grow well in. Give a reason for your answer.

[1]

- (c) Based on the graph, give a possible reason to explain the result obtained for water sample from pond X.

[1]

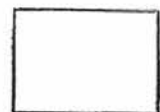

37. Shi Wei conducted the following experiment with a simple circuit as shown below. He started the experiment by connecting a very long rod Y to the circuit and measured the brightness of bulb B1 with the use of a data logger and a light sensor. He repeated his experiment with decreasing lengths of rod Y.

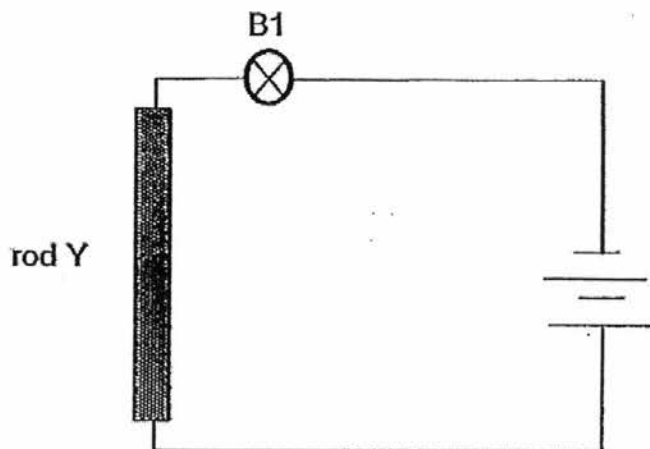

He recorded his results in the table below.

Length of rod Y (cm)	Brightness of B1 (lux)
2	900
4	700
6	()
8	300
10	100

- (a) What should the brightness of the bulb be when the length of rod Y is 6cm? Write the answer in the table above [1]
- (b) When Shi Wei closed the above circuit with a 4cm rod Y and added another similar bulb to the circuit, would the brightness of bulb B1 increase, decrease or remain the same? Explain your answer. [1]
- _____
- _____
- (c) When Shi Wei replaced rod Y with another rod W made of a different material, bulb B1 did not light up. What is rod W made of? [1]
- _____

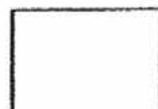

38. Study circuit A below.

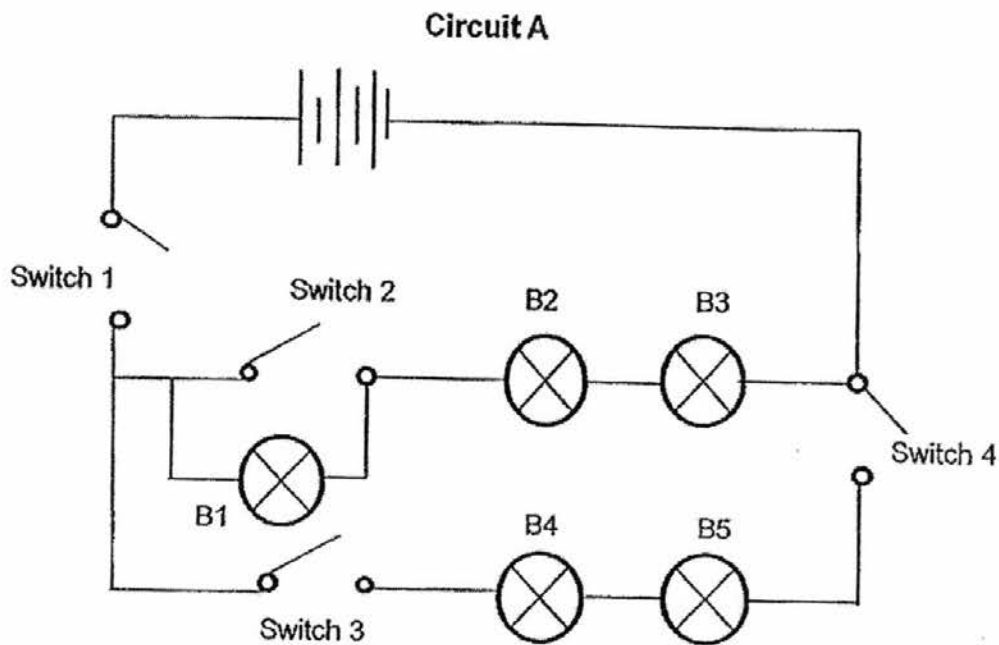

- (a) Complete the table below by stating the bulb(s) that would light up when different switches are closed. [2]

Switches that are closed	Bulbs that will light up
Switch 1	
Switch 1 and 4	
Switch 2, 3 and 4	
Switch 1, 3 and 4	



- (b) A circuit card is tested with a circuit tester and the results are recorded in the table below.

Clips tested	Bulb of circuit tester lights up?
A and B	Yes
A and D	No
B and E	Yes
C and E	Yes

- (i) Based on the results recorded in the table above, draw 3 lines in the circuit card below to show how the wires in the circuit card should be connected. [1]

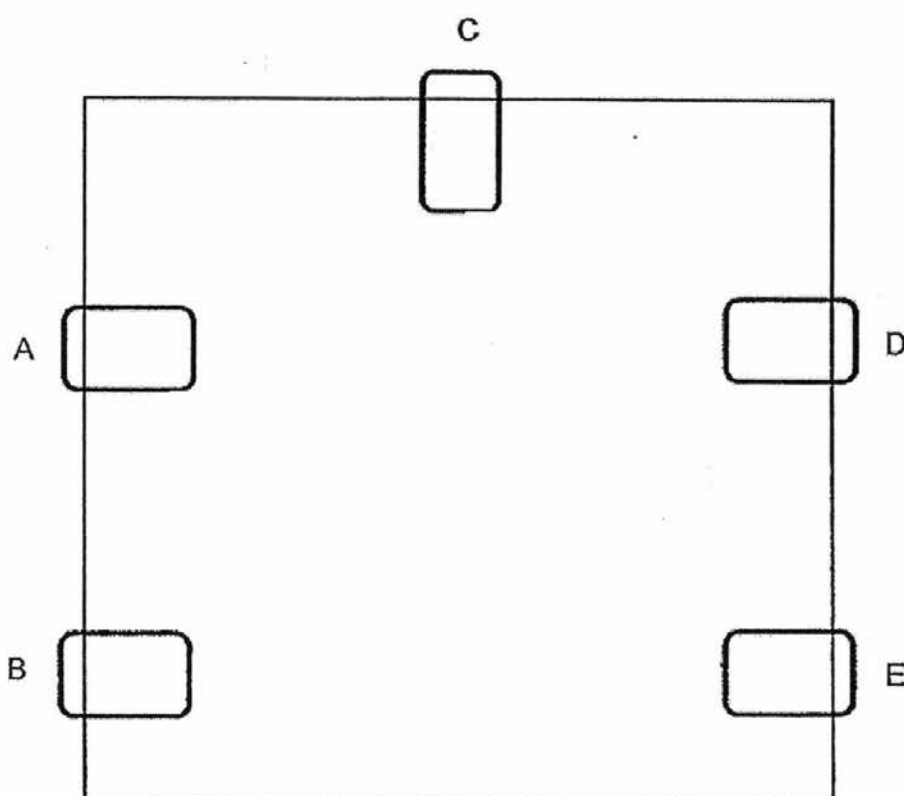

- (ii) Explain why the bulb in the circuit tester did not light up when clips A and D were tested. [1]



39. Matthew placed a solid made of substances P and S in a tank. Substance P has a lower melting point than substance S.

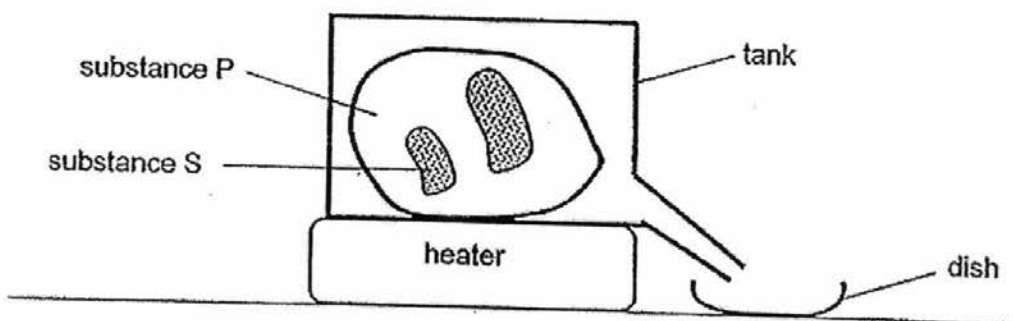

(a) He wanted to obtain a solid made of substance P only.

- (i) Explain how he could use the set-up above to do so. [2]

- (ii) In order to ensure that the solid does not contain substance S, at what temperature should he set the heater? [1]

(b) Matthew wanted to obtain a bar as shown below.



Suggest one change in the above set-up that would allow Matthew to obtain a bar as shown. Explain your answer. [1]

(c) What can Matthew do to obtain the bar made of substance P within a shorter time? [1]

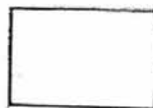

40. Elena filled a glass bottle with some water. She then placed the glass bottle in a container of water. The glass bottle floated slightly as shown in diagram 1.

When she filled the glass bottle with more water and placed it in a container of water, the glass bottle sank as shown in diagram 2.

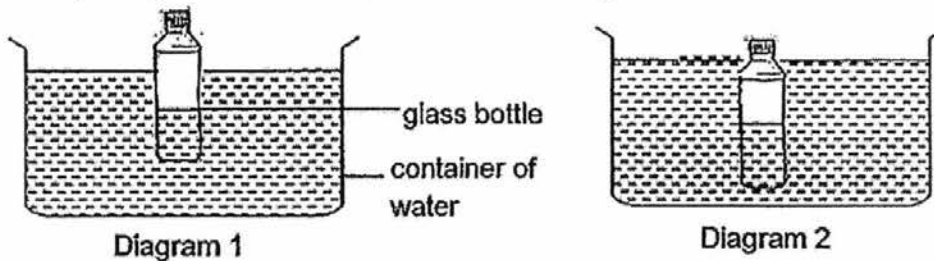

- (a) Give a reason why the glass bottle sank when it was filled with more water.

[1]

- (b) A submarine is a type of ship that can travel underwater in the sea. Some tanks which are filled with water can be found inside the submarine.

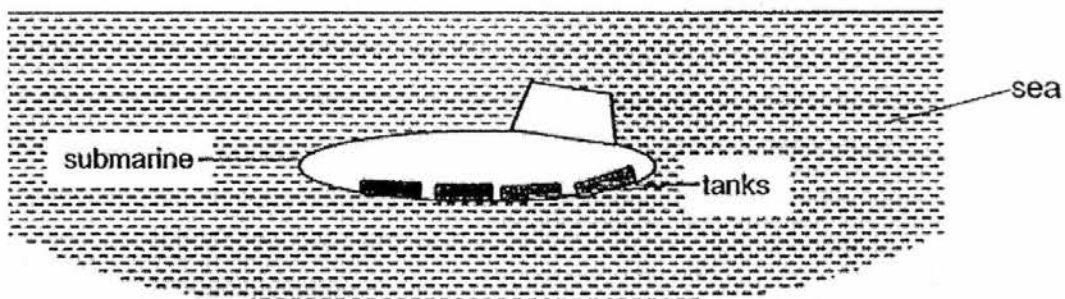

Based on Elena's experiment, what should be done to make the submarine rise to the surface of the sea?

[1]



- (c) In another experiment, Elena placed an empty bottle with two holes at points, R and S, into the container of water as shown below. She recorded the time taken for the bottle to sink to the bottom of the container.

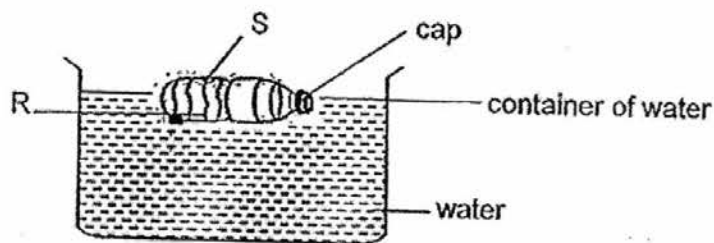

Give a reason why the plastic bottle sank after a while.

[2]

- (d) Elena wants to find out if the number of holes on the plastic bottle would affect the time taken for the plastic bottle to sink to the bottom of the container. Using the same apparatus, what could Elena do to carry out an investigation?

[1]

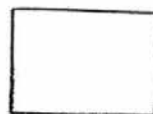

41. An experiment is set up as shown in the diagram. The bulb lights up when the switch is on.

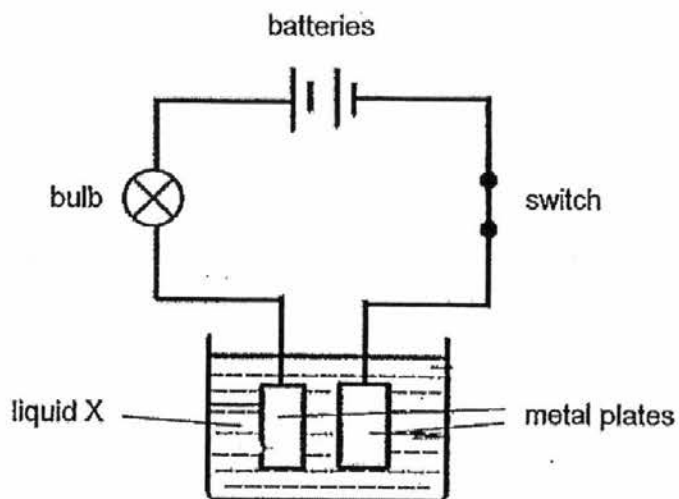

- (a) What does this experiment tell you about liquid X? [1]

- (b) What would you notice about the bulb if the number of batteries is increased? [1]

- (c) Give a reason for your answer in (b). [1]

- (d) Explain what you would observe if the metal plates are replaced with glass plates. [2]

End of Booklet B



EXAM PAPER 2016 (P5)

SCHOOL : CHIJ

SUBJECT : SCINECE

TERM : SA1

Q1	Q2	Q3	Q4	Q5	Q6	Q7	Q8	Q9	Q10
4	3	1	4	3	2	4	4	4	4
Q11	Q12	Q13	Q14	Q15	Q16	Q17	Q18	Q19	Q20
3	2	3	1	4	2	1	4	4	2
Q21	Q22	Q23	Q24	Q25	Q26	Q27	Q28		
1	2	2	3	3	1	3	3		

29)a)The animals in X has moist skin while the animals in Y have feathers for their outer covering.

b)Reason 1: It does not have 6 legs.

Reason 2: It does not have 3 body parts.

30)a)

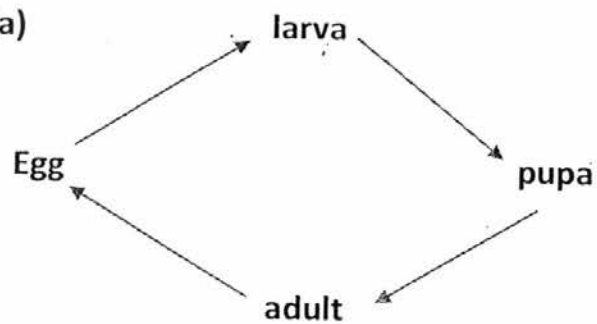

30)b)8

c)When some eggs are eaten, there will still be remaining eggs left.

31)a)S1: gills

S2: lungs

b)In a fish, the heart pumps the blood and blood enters the heart once and gets pumped to the gills and transported to the other parts of their body.

32)a)i)Z

ii)X

b)The roots of a plant is found underground and does not need to make food. Therefore, it does not have chloroplast which contain chlorophyll to make food for the plant.

33)a)Set up C. Although C had the least amount of roots and leaves the roots will still absorb some water in the container.

b)The plant with the most number of leaves is able to absorb the most water.

c)i)The same water level.

ii)The same amount of sunlight.

34)a)Strength

b)D. D could hold the most number of weights before breaking, therefore it is considered the strongest and most suitable to carry a 1.5 litre bottle of coke.

35)a)Cup W. The uneven part of the cup sleeves found on cup W decrease between the customer's hand and the hot drink. Hence, it will not feel so hot as there is lesser heat gain by the hand.

b)Property 1: flexibility

Property 2: poor conductor of heat

36)a) Different pond water.

b) Y. The most amount of light is able to pass through Y and A is able to receive sufficient light and grow.

c) The water was murky.

37)a) 500

b) Brightness decrease.

c) An insulator of electricity.

38)a)

Bulbs that will light up
B2, B3, B1
B1, B2, B3
None
B1, B2, B3, B4, B5

b)i)

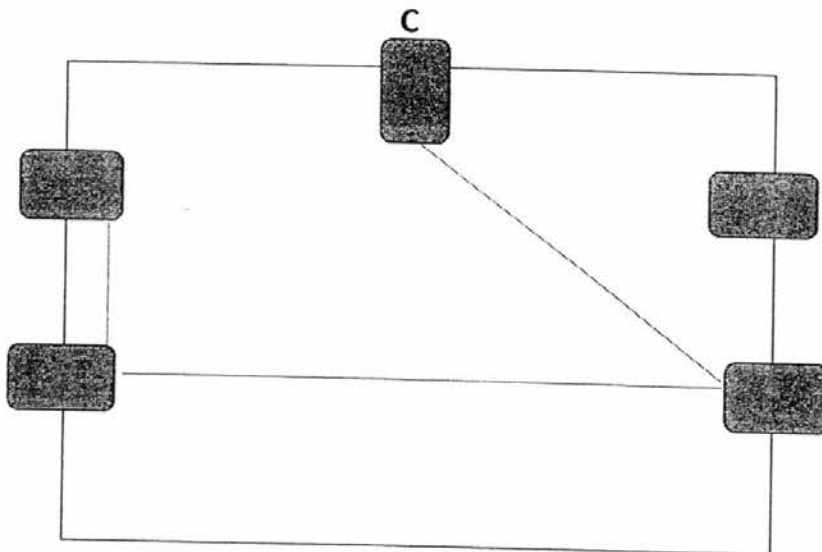

ii) D was made of an insulator of electricity and electricity was not able to pass through it.

39)a)i)Heat up the solid at the temperature that is all slightly higher than the melting point of P so that P will melt into a liquid to flow into the dish to cool.

ii)A temperature that is higher than the melting point P and lower than S melting point of P.

b)Change the dish to a rectangular container when P melts into a liquid it will flow into the container and take the shape of it.

c)Make the temperature colder.

40)a)The water in the bottle's mass increased so the glass bottle sank.

b)They should release the water into the sea.

c)Air in the bottle could escape through the holes and allow water to enter and take up the space that was once occupied by air.

d)Poke some holes in it.

41)a)X is a conductor of electricity.

b)It would be brighter.

c)The batteries would release more energy and the bulb would be brighter.

d)The bulb will not light up as glass is an insulator of electricity and does not allow electricity to pass through it. The circuit will become open and the bulb will not light up.