

TAO NAN SCHOOL
PRIMARY 5 SCIENCE YEAR-END EXAMINATION-2007

Name: _____ ()

Date: 25 October 2007

Class: P 5 (I)

Time: 8.00 - 9.45 a.m.

Parent's Signature: _____

Marks: _ _ /100

Section A (30 x 2 marks)

For each question from question 1 to 30, four options are given. One of them is the correct answer. Shade the correct oval (1, 2, 3 or 4) on the Optical Answer Sheet.

I.

CROP CHART

CROPS	MONTHS								
	JAN	FEB	MAR	APR	MAY	JUN	JUL	AUG	SEP
lettuce		△	△	△	●	●	●	●	●
broccoli		△	△	△ ●	△ ●	●	●	●	●
potato	△			●	●		△	△	
cabbage	●	●					△	△	△
pumpkin		●	●	●					△
melon	●	●	●						△
corn	●	●	●					△	△

KEY	
△	planting
●	harvesting

In what month would the farmer plant broccoli and lettuce and also harvest broccoli and pumpkins?

- (1) February
- (2) March
- (3) April
- (4) May

164

For questions 2 and 3 use the information below.

The food web shows the food relationships in a freshwater river.

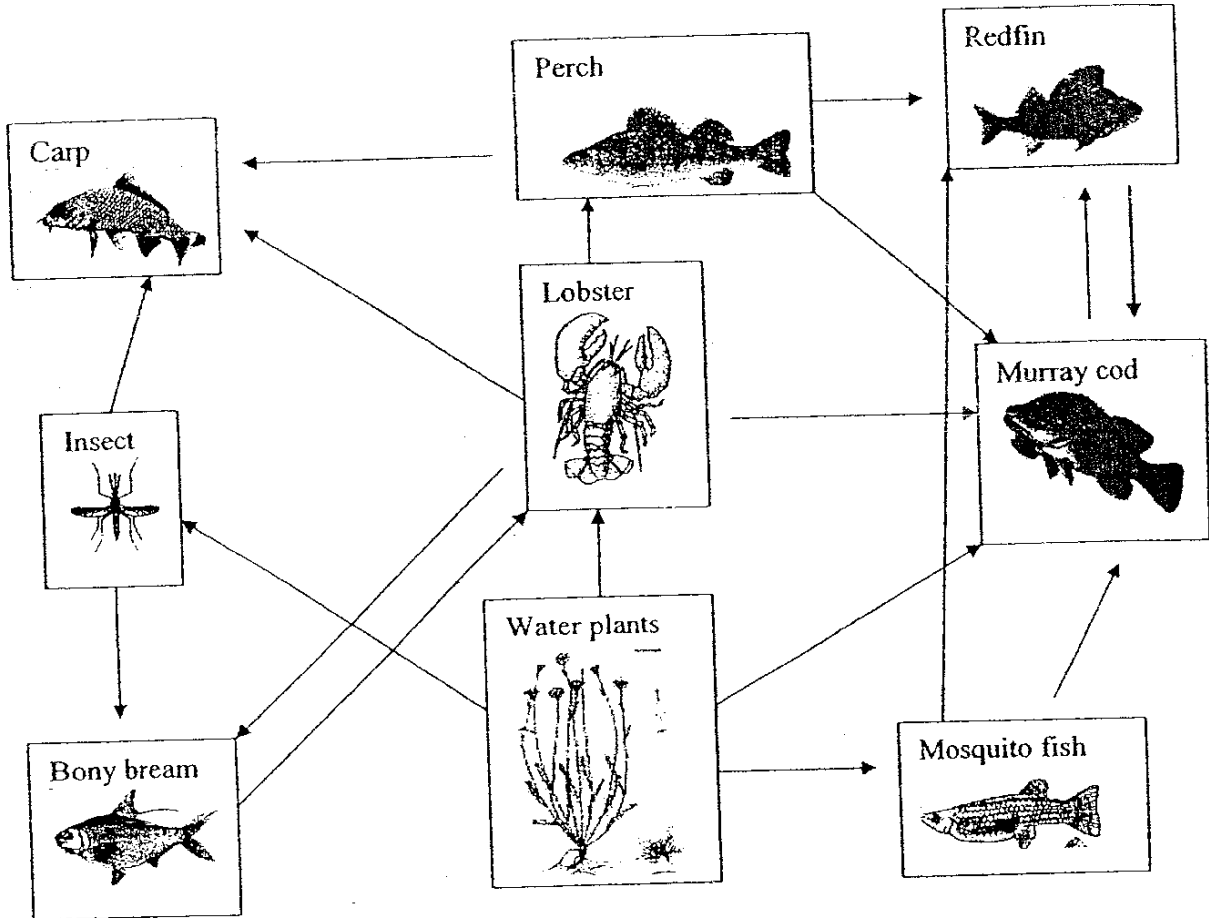

2. What is the Perch eaten by?

- (1) Lobster only
- (2) Carp and Redfin only
- (3) Lobster, Carp and Redfin only
- (4) Carp, Redfin and Murray cod only

3. Which one of the following is a herbivore?

- (1) Lobster
- (2) Murray cod
- (3) Bony beam
- (4) Mosquito fish

Study the diagram below and answer questions 4 and 5.

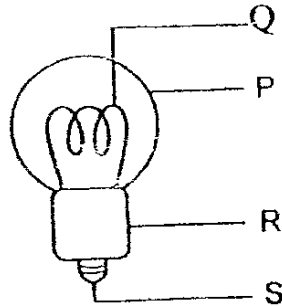

4. Which of the following statements about the part labelled Q are correct?
- A: It can be made of tungsten.
 - B: It melts when too much current flows through it.
 - C: It glows when the bulb is connected to an electric circuit.
- (1) C only
(2) A and B only
(3) B and C only
(4) A, B and C
5. Identify the two parts that have to be connected to an electric circuit so that the bulb lights up.
- (1) P and Q
 - (2) Q and R
 - (3) Q and S
 - (4) R and S

6. Study the classification below.

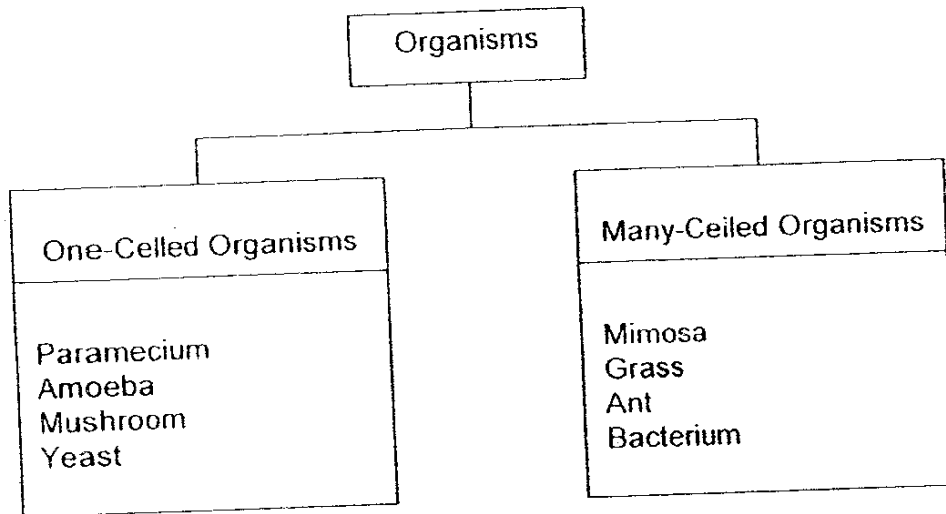

Which of the following organisms have been classified **incorrectly**?

- (1) Yeast and Mimosa
- (2) Amoeba and Grass
- (3) Mushroom and Bacterium
- (4) Paramecium and Ant

7. Study the classification chart below carefully.

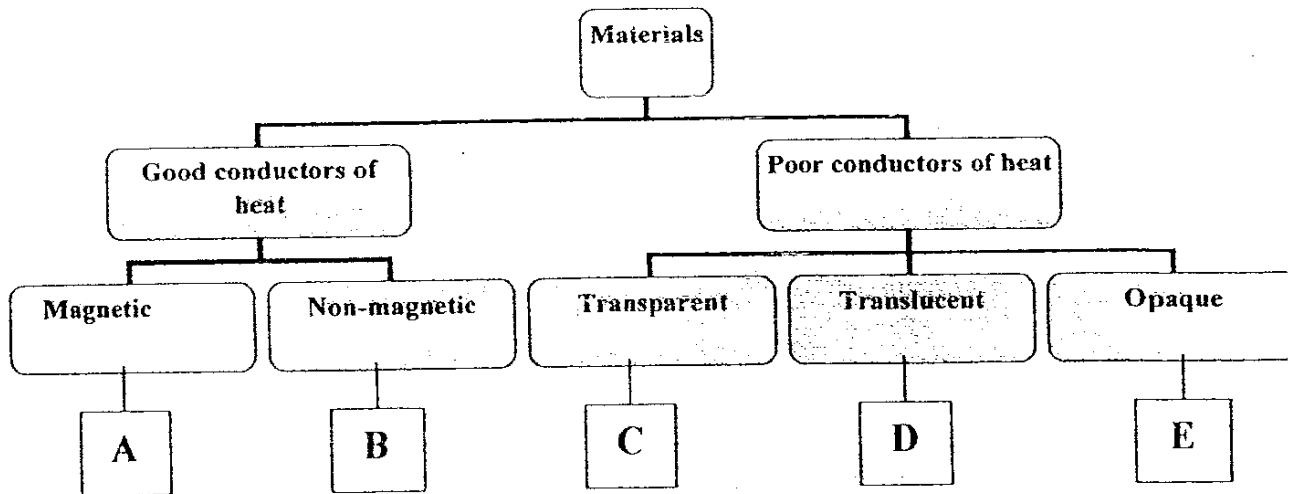

What can A, B, C, D and E be?

	A	B	C	D	E
(1)	steel	copper	frosted glass	tinted glass	cloth
(2)	cobalt	mercury	clear plastic	frosted glass	styrofoam
(3)	silver	nickel	tin	oil	leather
(4)	iron	aluminium	clear water	frosted plastic	wood

8. The equation below shows the process of respiration.

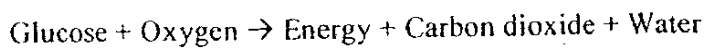

Which of the following is true?

- A: It takes place in the cell.
- B: In plants, it takes place during the day and night.
- C: Sunlight provides energy for respiration in plants.
- D: Energy, carbon dioxide and water vapour are the products of respiration.

- (1) A and B only
- (2) C and D only
- (3) A, B and D only
- (4) A, B, C and D

9. Which one of the following statements is **true**?

- (1) Root cells make chlorophyll in their cytoplasm.
- (2) Plant cells have cell walls but no cell membrane.
- (3) Leaf cells manufacture starch during photosynthesis.
- (4) Leaf cells have chloroplasts to trap light energy for photosynthesis.

10. Which of the following circuits will have **at least one** bulb lighted up?

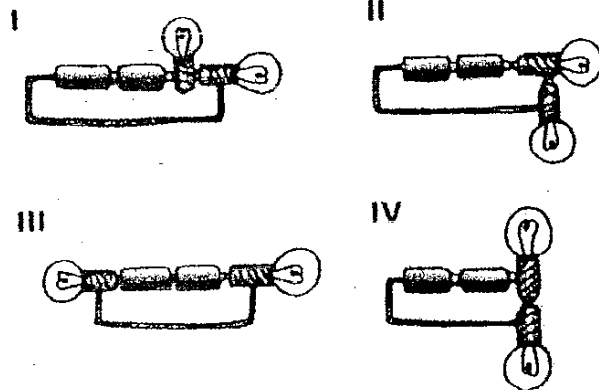

- (1) I only
- (2) III and IV only
- (3) II, III and IV only
- (4) All of the above

11. Where does fertilization takes place in the female reproductive system below?

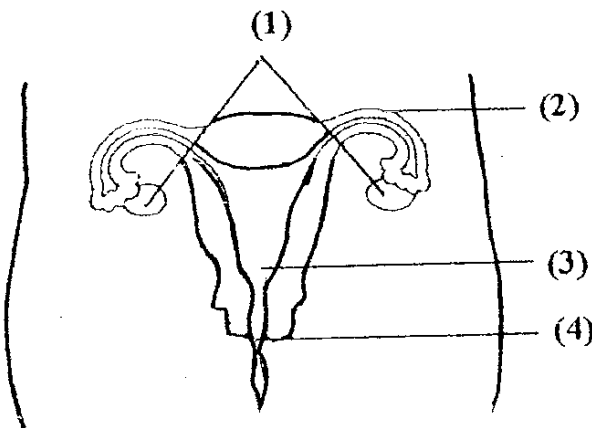

169

12. Below are statements about fungi made by four pupils. Which pupil made an incorrect statement?

- (1) Jonathan: Yeast and bread mould are examples of fungi.
- (2) Marcus: Fungi feed on decaying matter.
- (3) Eliza: All fungi are poisonous.
- (4) Chlce: Fungi undergoes respiration.

13. Richard balanced 2 loads, Load A and Load B on a lever as shown below.

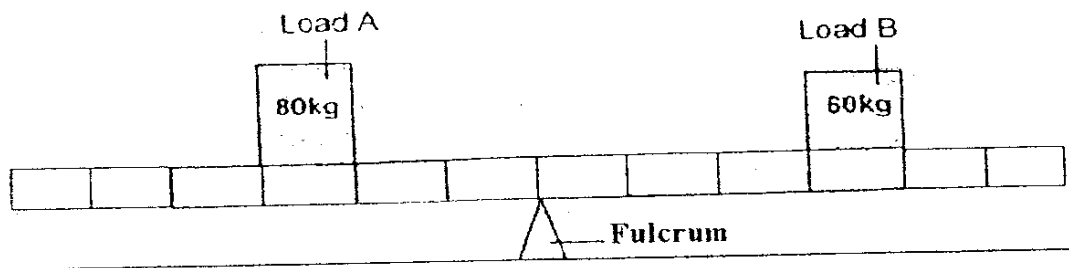

What should he do to make Load B tilt up?

- (1) He should move Load A towards the fulcrum.
- (2) He should move the fulcrum away from Load B.
- (3) He should move Load B towards the fulcrum.
- (4) He should move the fulcrum towards Load A.

170

14. Below is a classification table.

A	i	has legs	Go to B
	ii	does not have legs	go to D
B	i	8 legs or less	Go to E
	ii	more than 8 legs	go to F
C	i	body with no shell	Go to F
	ii	body with a shell	Mollusc
D	i	body with rings	Annelid
	ii	body with no rings	Nematode
E	i	6 legs	Insect
	ii	8 legs	Arachnid
F	i	all legs are of the same length	Myriapod
	ii	not all legs are of the same length	Crustacean



Using the classification table given, what is the organism above?

- (1) Annelid
- (2) Arachnid
- (3) Myriapod
- (4) Crustacean

(7)

15. Study the diagram of the wheel and axle below carefully.

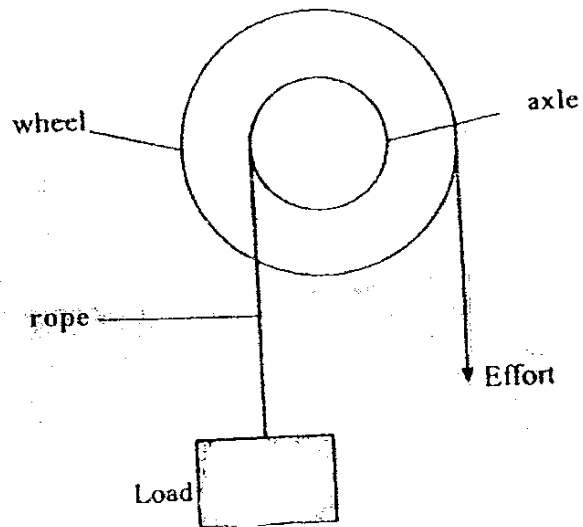

Which of the following conditions will require a bigger effort to lift the load?

- A: Increase the mass of the load.
- B: Increase the size of the axle.
- C: Increase the size of the wheel.

- (1) C only
- (2) A and B only
- (3) B and C only
- (4) A, B and C only

- 16 Which one of the following is an example of a pull?

- (1) Kicking a soccer ball.
- (2) Flicking an ant crawling on my shirt.
- (3) Pressing the buttons of a remote control.
- (4) Lifting a lid from a plastic food container.

17. A motor turns a driving gear in a machine at 10 turns per minute. The driving gear is attached to another gear that completes 24 turns a minute.

Which diagram represents the gear in this machine?

(1)

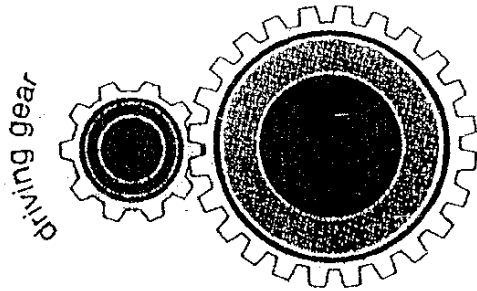

(2)

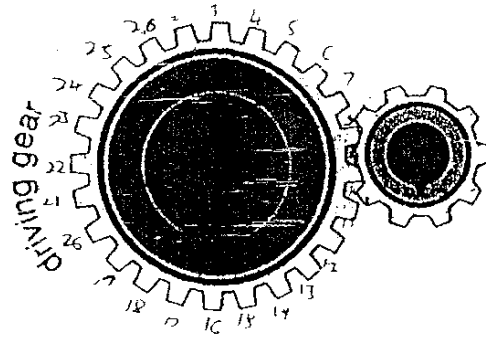

(3)

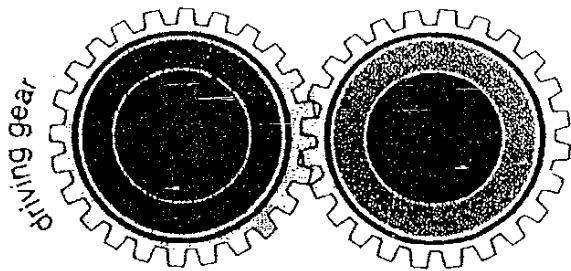

(4)

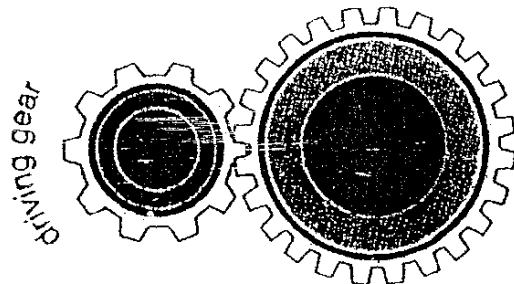

18. The table below shows some changes that take place around us and the result of these changes. Which of the following shows the result correctly?

	Change	Result
(1)	Revolution of the Earth	Day and night
(2)	No wind for a month	Low tide
(3)	Cutting of trees in a forest	Death of some animals.
(4)	Evaporation of water from a lake.	Drought in the country

19. The diagram below shows the position of the shadow cast by a stick at 4 different times during a day. Which diagram shows a shadow cast at 6.00pm?

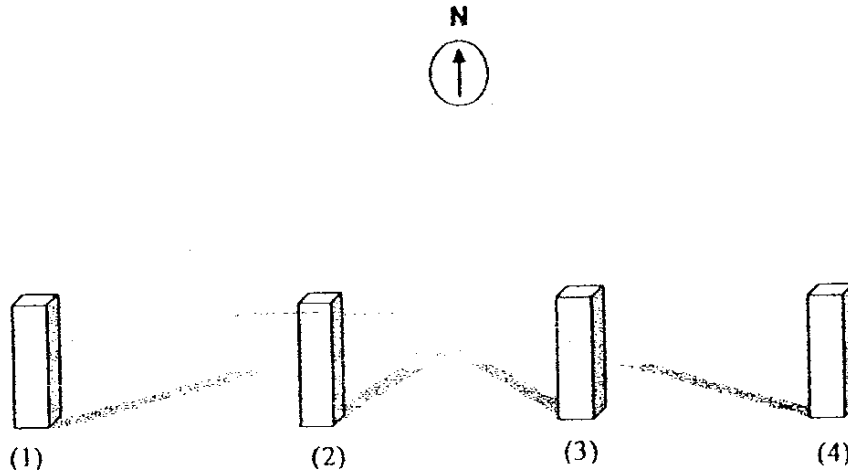

20. Henry has been advised never to touch a switch when his hands are wet. Which one of the following is the best reason?
- (1) The wires may rust.
 - (2) He may dirty the switch.
 - (3) He may get electrocuted.
 - (4) The switch may not work if it gets wet.

174

21 The diagram below shows 3 buzzers, A, B and C in a circuit.

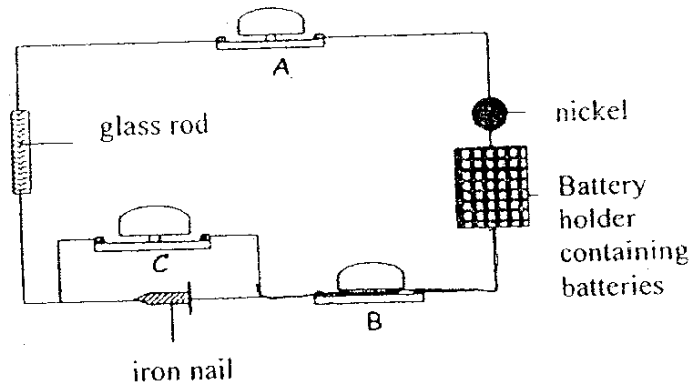

Which buzzer(s) will sound?

- (1) C only
- (2) A and B only
- (3) All of the buzzers
- (4) None of the buzzers

22 Which is the function of the cell wall of a plant cell?

- (1) It keeps the plant upright.
- (2) It absorbs water from the soil.
- (3) It controls the activities in the plant cell.
- (4) It helps to maintain the shape of the plant cell.

175

23. John carried out an experiment to determine the effects of objects of different masses on a spring. A line graph was plotted as shown below after the experiment.

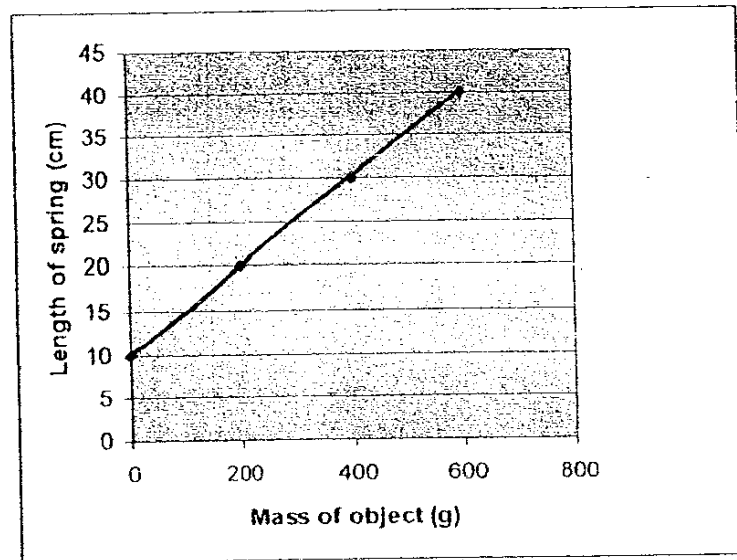

What can John conclude from the line graph above?

- A: The length of the spring increases proportionately with respect to the mass of the object.
- B: Doubling the mass will double the length of the spring.
- C: When a 600g object is hung on the spring, the length of the spring is 30cm.
- D: The extension of the spring is 15cm when a 300g object is hung on it.

- (1) A and B only
- (2) A and D only
- (3) B and C only
- (4) C and D only

176

24. Our blood can be classified into four groups – A, B, AB and O.

The table below shows how the blood types of blood donors and recipients are matched.

Blood Type	Blood type of person donating blood			
	A	B	AB	O
Blood type of person receiving blood				
A	Yes	No	No	Yes
B	No	Yes	No	Yes
AB	Yes	Yes	Yes	Yes
O	No	No	No	Yes

Michael's family members have the following blood types:

Father - B
Mother - A
Brother - AB
Sister - O
Michael - B

If Michael needs a blood transfusion, who can he receive blood from?

- (1) His father only
- (2) His mother and brother only
- (3) His father and his sister only
- (4) His father, brother and sister only

137

25. Li Ying carried out the experiment below.

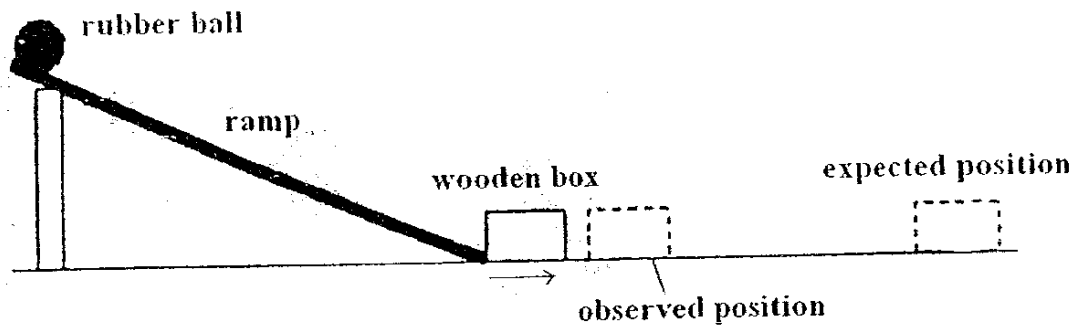

When she released the rubber ball, the box did not move as far as she had expected. What could she do to the set-up to ensure that the box moves to the expected position or further?

- A: Lower the ramp.
- B: Use a heavier ball.
- C: Use a smoother ramp.
- D: Add weights to the wooden box.

- (1) A and B only
- (2) A and D only
- (3) B and C only
- (4) C and D only

26. The diagram below shows the stages of reproduction of a yeast cell.

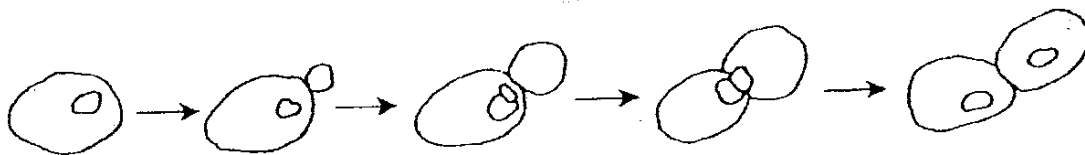

Which one of the following about this process is **incorrect**?

- (1) This method of reproduction is called budding.
- (2) The young cell and the parent cell share the same nucleus.
- (3) The young cell has the same characteristics as the parent cell.
- (4) Part of the cytoplasm of the young cell comes from the parent cell.

27. The diagram below shows certain objects in the Solar System

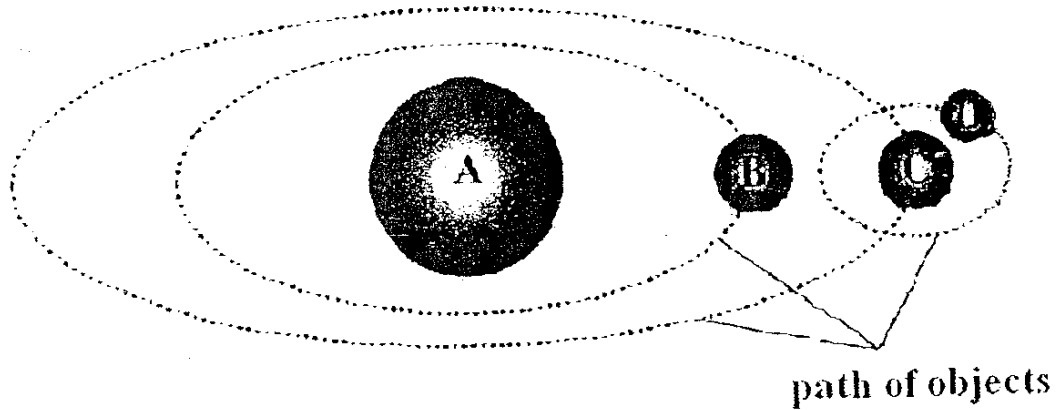

Object A is the source of light and heat.
 Object B and Object C move around object A.
 Object D moves around object C.

What are Object A, Object B, Object C and Object D?

	A	B	C	D
(1)	Sun	Mercury	Earth	Moon
(2)	Sun	Earth	Moon	Mercury
(3)	Moon	Earth	Mercury	Sun
(4)	Moon	Mercury	Earth	Sun

179

28 Below are the steps of a starch test.

- A — Pluck a leaf from a plant.
- B — Leave the plant in the Sun for a few days.
- C — Soak the leaf in a test tube of alcohol and place the test tube in hot water.
- D — Boil the leaf in water.
- E — Wash the leaf and then add a few drops of iodine solution over it.

Which of the following arrangements show the correct order of the starch test?

- (1) A, B, C, D, E
(2) A, B, D, C, E
(3) B, A, C, D, E
(4) B, A, D, C, E

29. In which of the following is/are heat produced?

- A: Striking a match.
B: Watering a plant.
C: Hitting a nail with a hammer

- (1) A only
(2) C only
(3) A and C only
(4) B and C only

180

30. The following diagram shows a circuit card.

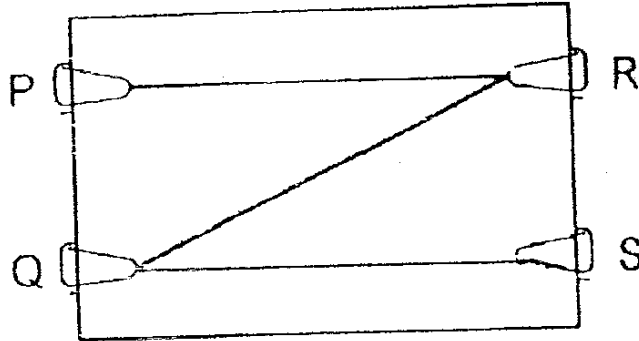

Pairs of clips were tested with a circuit tester.

Yes- Represents allow electricity to flow through.

No - Represents do not allow electricity to flow through.

Which of the following shows the result when the pairs of clips were tested with the circuit tester?

		P	Q	R	S
(1)	P		No	Yes	No
(2)	Q	No		Yes	Yes
(3)	R	Yes	Yes		No
(4)	S	Yes	Yes	Yes	

181

Name: _____ ()
Class : 5 ()

Section B (40 marks)

For questions 31 to 46, write your answers in the spaces provided.

Q31. Ying Run set up 2 circuits using three batteries and a bulb. The type of batteries and bulb used for the 2 circuits are also the same.

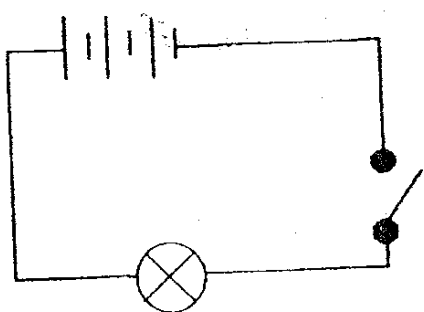

Setup A

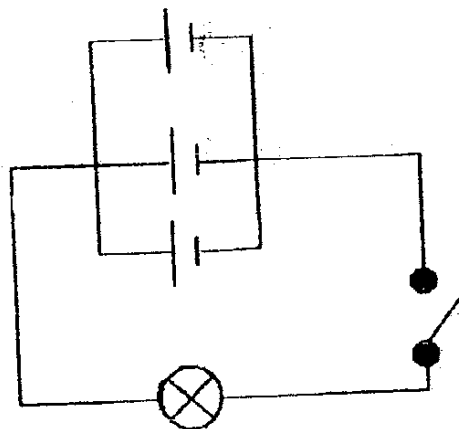

Setup B

- (a) When the switch is closed, the bulb in which setup will be brighter? Explain your answer. (1m)
- (b) Give one advantage of the arrangement of batteries in Setup B. (1m)

Q32. The same spring is used to move a toy car to the top of a block in two different ways as shown in the following setups.

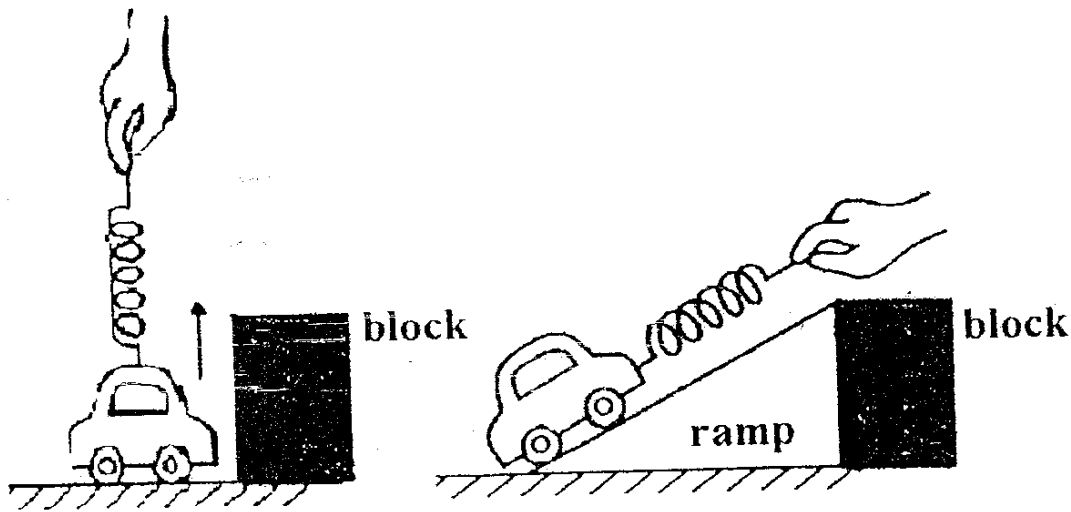

Setup X

Setup Y

	Setup X	Setup Y
Original length of spring	10 cm	10 cm
Length of the extended spring when the toy car is moved	16 cm	14 cm
Distance travelled by the toy car	8 cm	12 cm

(a) Which one of the two setups requires greater effort to move the toy car? Why? (1m)

(b) From the results given, what is the advantage of using the way in Setup X to move the toy car to the top of the block? (1m)

(c) What is the length of the extension of the spring in Setup Y? (1m)

33. Classify the substances in the box below in the table provided. (2m)

Substances:

Steam	Blood	Alcohol
Snow	Helium	Oil

Solid	Liquid	Gas

34. Alex connected two identical empty bottles and a glass tubing as shown in the diagram below. In the glass tubing, he had added a drop of red ink. He then placed each of the empty bottles in a basin of water.

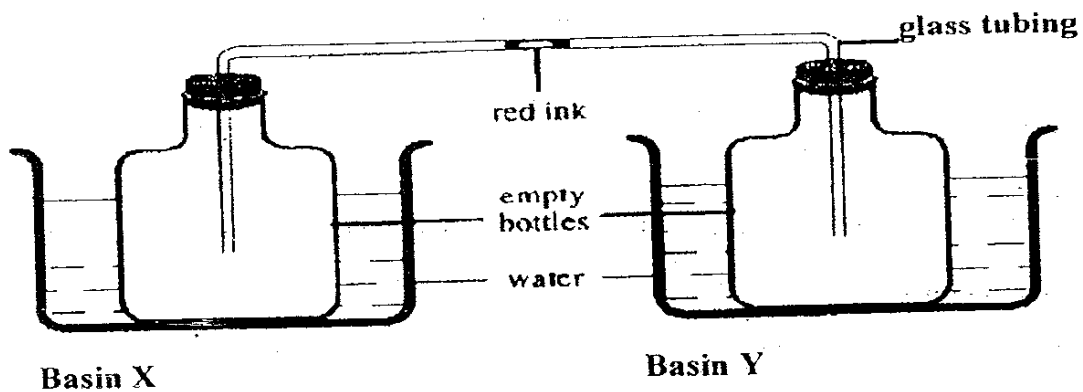

(a) In the table below, state the direction of the movement of the red ink by writing "Towards X" or "Towards Y" when the water has the following set of temperatures. (1m)

	Temperature of water (°C)		Direction of movement of the drop of red ink
	Basin X	Basin Y	
(i)	10	90	
(ii)	90	10	

(b) Explain your answer in (a), (i). (2m)

184

35. Clara drew the chart below to classify **plants** based on their methods of reproduction.

Complete the chart by filling in the empty boxes (a) and (b). (2m)

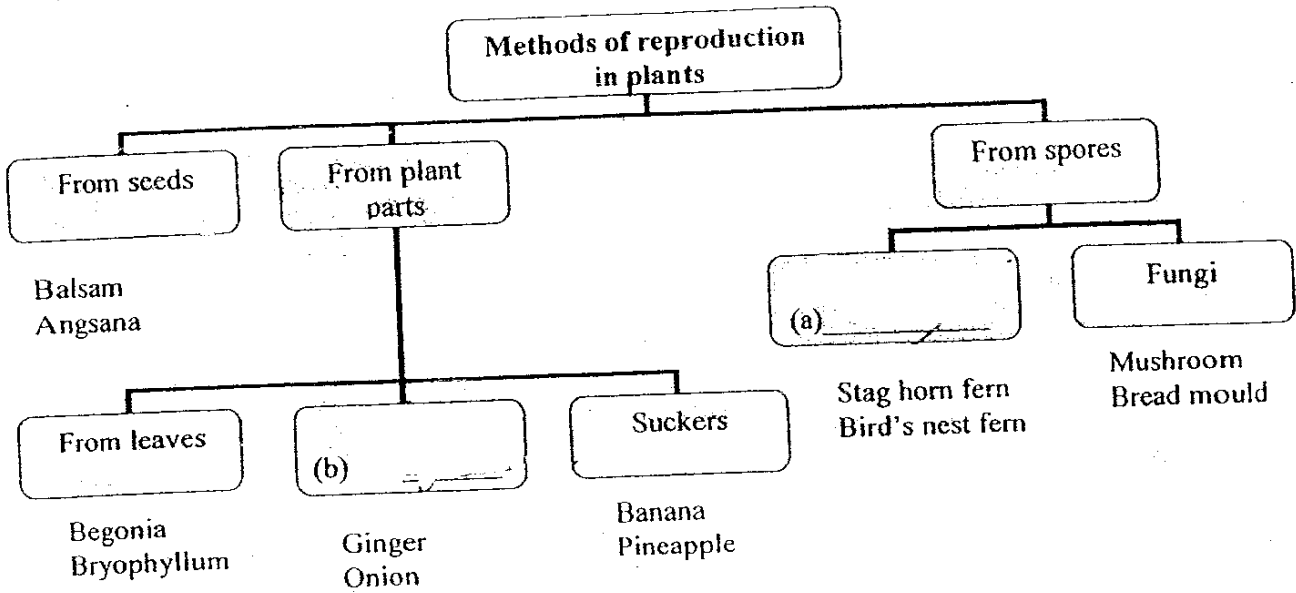

(c) Clara was told that there is an error in her chart. What is the error that Clara had made? (1m)

185

36. Read the following statements carefully.

- A: ~~The lungs expand.~~ The chest becomes bigger
- B: The air goes into the lungs.
- C: Air goes through the nose.
- D: The air goes into the windpipe.
- E: ~~Hairs in the nose trap dust and dirt present in the air.~~

Arrange the above statements in the correct order to describe what happens during breathing. The first has been done for you. (2m)

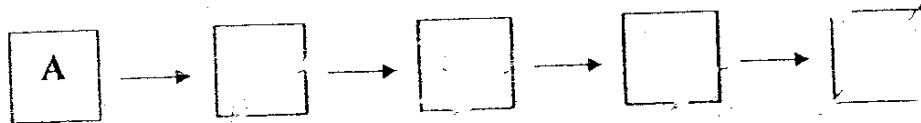

37. A substance has to pass through various parts of a plant cell before reaching the nucleus.

(a) Use the words given below to write the correct order in which the substance has to pass through. (1m)

Cell membrane Cytoplasm Cell wall

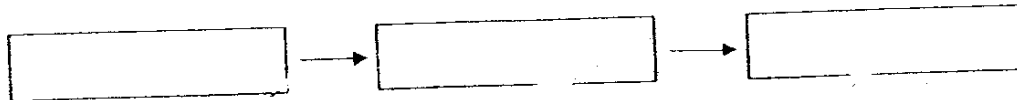

(b) Which organelle in the plant cell helps it to make food? (1m)

186

38. James measured the temperature of the air inside a covered glass container.

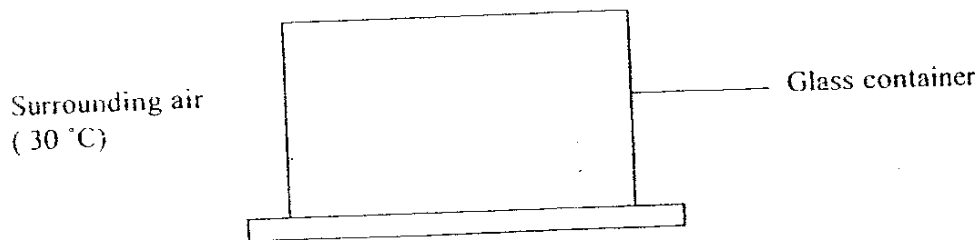

He then placed a lighted lamp inside the same covered container as shown below.

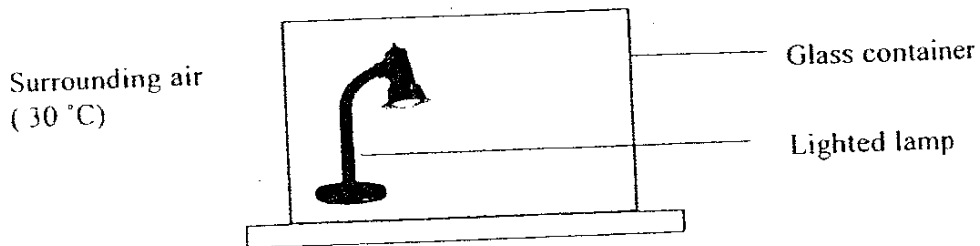

He took the temperature of the air inside the container every 20 minutes, for one hour.

- (a) Draw the temperature ^{Line} ~~time~~ graph to show the change in the temperature of the air inside the covered glass container during this hour. (1m)

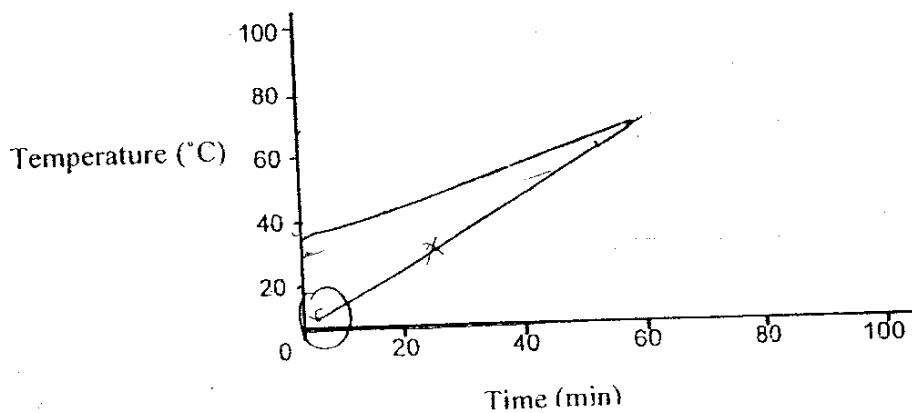

- (b) Explain the change in temperature of the air inside the covered glass container during this hour. (1m)
-
-

39. Look at the diagram of an insect-pollinated flower below.

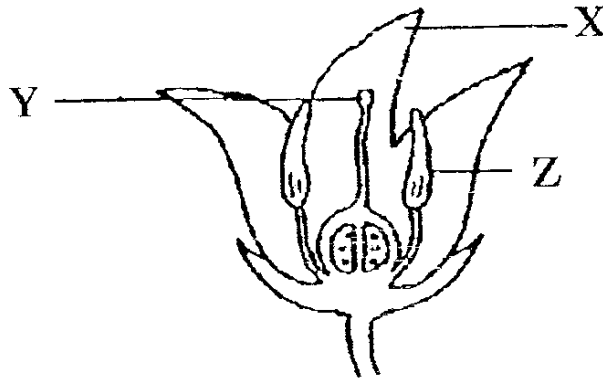

Identify the parts marked X, Y and Z and their corresponding functions in the table below.
(3m)

	Plant Part	Function
X		
Y		
Z		

188

40. Zheng Wei set up the circuit below using 2 bulbs, B1 and B2, and three switches, S1, S2 and S3.

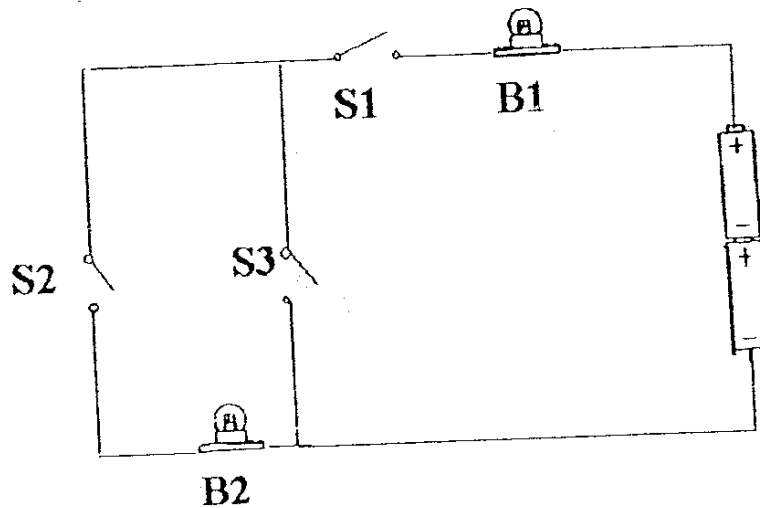

He wanted to find out which of the bulbs, B1 and B2, will light up when the switches were opened and closed. He recorded some of the data he collected in the table below.

(a) Fill in the empty boxes to complete the table. (3m)

	Switches			Did the bulb light up?	
	S1	S2	S3	B1	B2
i)	Open	Closed	Closed		
ii)	Closed	Closed	Open		
iii)	Open	Open	Closed		

(b) What could we do to make the bulbs glow more brightly? (1m)

189

41. The diagram below shows cells produced by a man and a woman. The cells are labelled, Cell A and Cell B respectively.

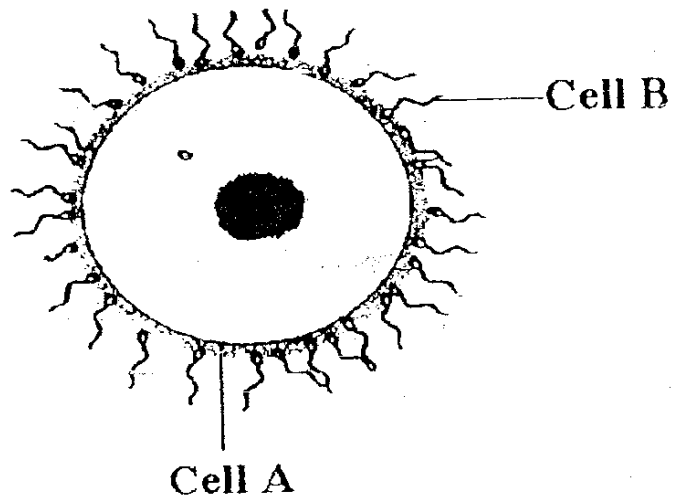

- (a) Identify Cell A and Cell B. (1m)

Cell A : _____

Cell B : _____

- (b) Which reproductive organ is Cell B produced in? (1m)
-

42. Linda observes 4 fruits each with a different method of fruit/seed dispersal and describes them as follows:

Fruit A: The fruit has a fibrous husk that traps air.

Fruit B: The fruit is fleshy, tasty and has a bright orange skin.

Fruit C: The fruit has a few seeds. It is pod-like and has a dry brown skin when ripe.

Fruit D: The fruit is small with one seed. It is tipped with a tuft of fine soft hair.

Based on the characteristics of the fruits, how are they dispersed? (2m)

Fruit	Method of fruit/seed dispersal
Fruit A	
Fruit B	
Fruit C	
Fruit D	

43. Yu Hui carries out an experiment according to the steps below:

Step 1: Fill a bottle with warm water.

Step 2: Add about 20g of glucose to the water in the bottle and stir.

Step 3: Add about 10g of yeast to the solution in the bottle.

Step 4: Stir the mixture well.

Step 5: Stretch a balloon over the top of the bottle. Use a rubber band to secure the balloon. Observe the balloon after 10 minutes.

Observation: Gas X is produced.

(a) What is Gas X? What can Yu Hui do to identify Gas X? (1m)

(b) Identify the process that has taken place in the experiment? (1m)

44. Terry carried out 4 different activities for the same duration. These activities are represented by the letters A, B, C and D. He then measured his breathing rate and pulse rate for each activity. The results are shown in the table below.

Activity	Breathing rate (per minute)	Pulse rate (per minute)
A	30	66
B	36	70
C	50	105
D	70	140

- (a) Match the activities A, B, C and D that Terry carried out with their corresponding descriptions. Each activity A, B, C and D can only be used once. (2m)

Description	Activity
Strolling in a park	
Jogging on the spot	
Sleeping at home	
Running a 100m race	

- (b) What is the relationship between his breathing rate and his pulse rate? (1m)

192

45. During a Science lesson

I have very good eyesight and do not need to use the microscope to look at the plant cells.



Zachery

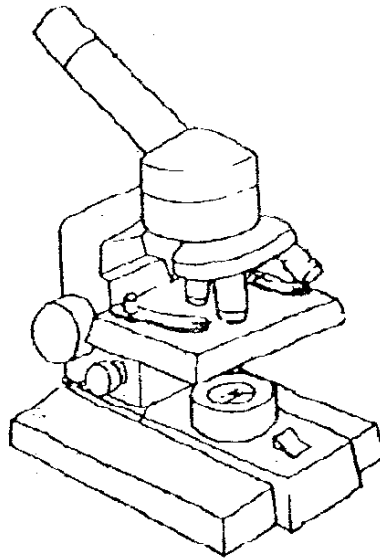

Using a microscope is much more effective.



Thomas

(a) Why did Thomas insist that it is better to use a microscope? (1m)

The boys wrote down the procedure when using the microscope. However, they missed out some words and would need your help to fill in the blanks to complete the procedure. (2m)

Procedure

Step 1: Switch on the power.

Step 2: Turn the (a) ^(b) _____ to the lowest magnification (Lower the ^(b) _____). Place the glass slide on it. _(c)

Step 3: To see more clearly, adjust the (c) _____ while looking through the (d) _____. You should be able to see the enlarged specimen.

193

46. Rachel and Audrey set up an electromagnet as shown below. They wanted to investigate how the material of the rod affects the number of paper clips attracted. Four rods A, B, C and D, each made of a different material is used. The same number of paper clips is used to test each material.

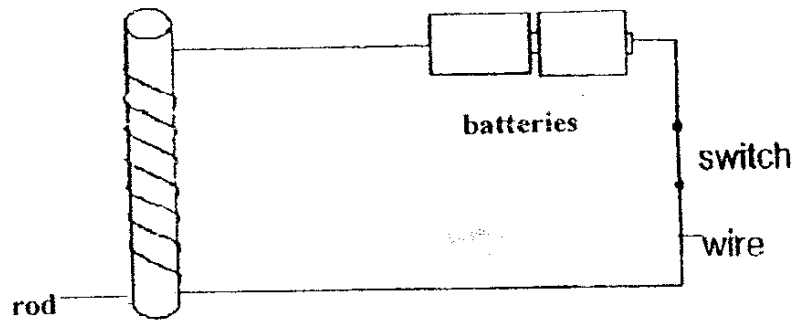

Their teacher required them to control their variables as shown below.

	Changed variable	Constant variable
Material of rod	√	
Number and type of batteries		√
Type of wire		√

The two girls also recorded the number of paper clips attracted and the number of turns of the wire around the rod.

Rod	Number of paper clips attracted	Number of turns of the wire
A	10	7
B	0	10
C	5	7
D	2	7

- (a) Their teacher looked at the recordings in the two tables and told the two girls that they did not conduct a fair test. Why is this so? (1m)

- (b) What variable was being measured? (1m)

- (c) What material is rod A made of? (1m)

ok

Tao Nan Primary School

Primary 5 Science SA2 Exams (2007)

Answer Keys

SECTION A : (60 MARKS)

Qn no.	Ans
1	3
2	4
3	4
4	4
5	3
6	4
7	3
8	3
9	4
10	4

Qn no.	Ans
11	2
12	3
13	3
14	3
15	2
16	4
17	2
18	3
19	1
20	3

Qn no.	Ans
21	4
22	4
23	2
24	3
25	3
26	2
27	1
28	4
29	3
30	4

SECTION B (40 MARKS)

- 31a. The bulb in setup A. Its batteries are arranged in series while in setup B arranged in parallel.
- 31b. They will make the bulb in the setup B last for longer time
- 32a. Setup X. In setup X, the toy car moves a shorter distance than setup Y. Hence greater effort is required
- 32b. It dose to have to go over a longer distance
- 32c. 14cm
33. Solid : Snow
Liquid: Blood, Oil, Alcohol
Gas: Steam, Helium
- 34a. i) Towards X ii) Towards Y
- 34b. When the water in Basin Y is heated, the air in the empty bottle expands, hence pushing the ink drop towards X.
- 35a. Ferns
- 35b. Underground stem.
- 35c. Fungi are not plant but she classified them as plants.
36. A → C → D → B
- 37a. Cell wall → Cell membrane → Cytoplasm

37b. Chloroplast.

38a.

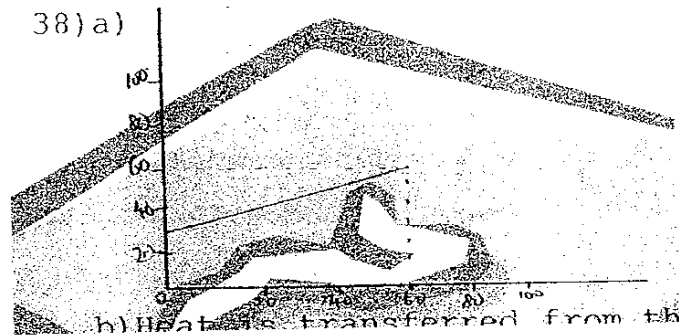

38b. Heat is transferred from the lamp to the air in the container.

39. X : Petals : It is to attract insect to pollinate the flower.
Y : Stigma : It is to trap the pollen grains.
Z : Anthers : It produces pollen grains.

40a i) No, No

40a ii) Yes, Yes

40a iii) No, No

40b. We could arrange the bulb in parallel position.

41a. A: Egg cell. B: Sperm.

41b. Testes

42. A: Water

B: Animals

C: Splitting

D: Wind

43a. She can pass the gas into a beaker of limewater. If the limewater turns chalky, the gas is carbon dioxide.

43b. Respiration.

44a. B,C,A,D

44b. The more his breathing rate, the more his pulse rate.

45a. The microscope can magnify the plant cells so that the plant cell is clearer.

45b. Step 2) b) Objective lens, a) stage

Step 3) c) focus knob, d) eye piece

46a. They changed two variables instead of one.

46b. The number of paper clips attracted.

46c. Steel.