



RAFFLES GIRLS' PRIMARY SCHOOL
WEIGHTED ASSESSMENT (1)

Your Score	25
Parent's signature	

Name : _____ Index No.: _____ Class: P5 _____ Date: _____

SCIENCE

Duration: 40 minutes

For questions 1 to 6, write your answers clearly in the spaces provided.
The number of marks is shown in brackets [] at the end of each question or part question.

1. The diagram below shows the parts of the reproductive systems A, B and C.

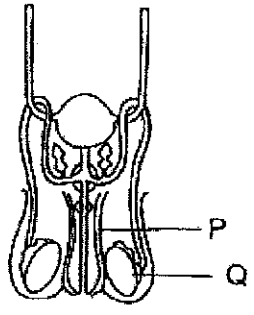

A

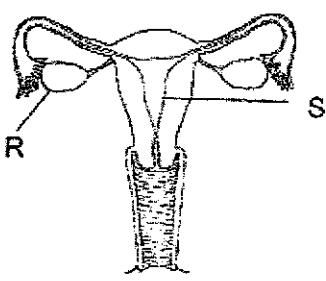

B

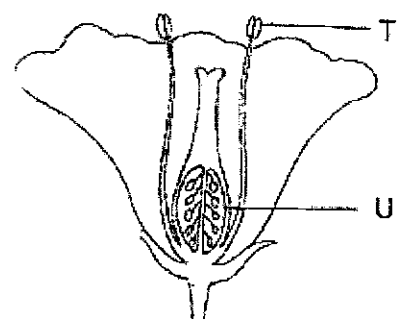

C

(a) Identify the parts of the reproductive systems of B and C that produce the egg cell respectively. [1]

Reproductive System B: _____

Reproductive System C: _____

Score	1
-------	---

Continue on next page

Continued from previous page

- (b) Compare the sexual reproduction process between systems B and C and state a similarity between them. [1]

- (c) State one similarity in the function between parts Q and T. [1]

Score	2
-------	---

2. The diagram below shows the cross section of flower X.

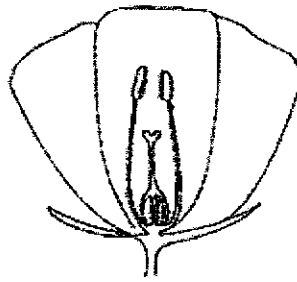

flower X

(a) Based on your observation of flower X, explain why it is not pollinated by wind. [1]

(b) Name the part of the flower that receive the pollen grains. [1]

The diagram below shows the cross section of flower Y on the same plant. Some parts are covered with plastic bags as shown below.

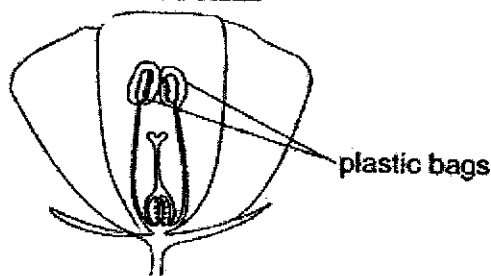

flower Y

(c) Mary commented that flower Y could develop into a fruit. Do you agree with her? Give a reason for your answer. [1]

Score	3
-------	---

3. Judy planted a seed of plant M into a pot of damp soil and observed its growth for eight days. She recorded the masses of the seed leaf and the shoot of the seedling over eight days and recorded the results as shown in the graph below.

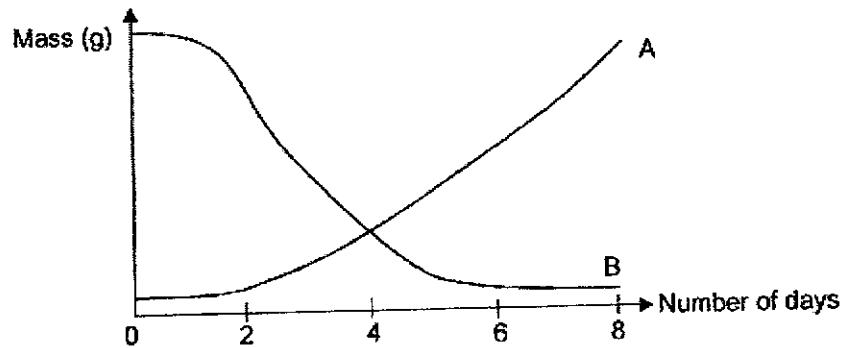

- (a) Which line, A or B, shows the change in the mass of the seed leaf during the experiment? Explain your answer. [1]

Continue on next page

Score	1
-------	---

Continued from previous page

Judy prepared three set-ups, A, B and C, using identical seeds from plant M as shown in the diagram below. She wanted to find out if the number of seeds will affect the growth of the germinating seeds.

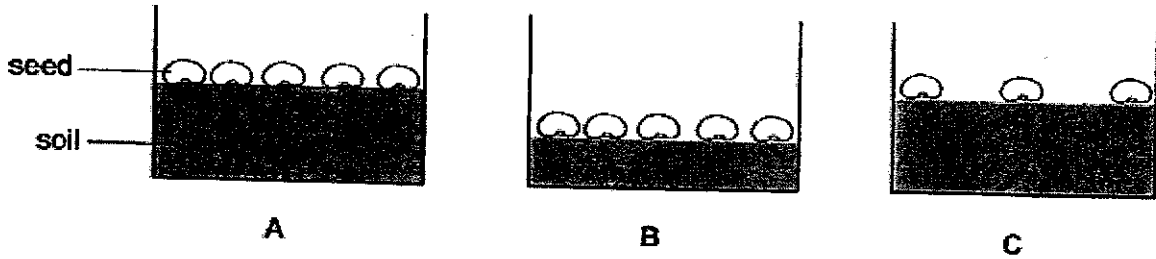

(b) Identify the following variables: [2]

(i) Independent variable(changed variable):

(ii) Dependent variable:

(c) Which set-ups should she use in order to conduct a fair test? [1]

(d) State another variable that must be kept the same to ensure a fair test. [1]

Score	4
-------	---

4. Sam prepared an experimental set-up as shown below. He heated a ball of wax in a layered cup with 7cm^3 of air trapped in between the layers. He repeated the experiment with different amounts of trapped air.

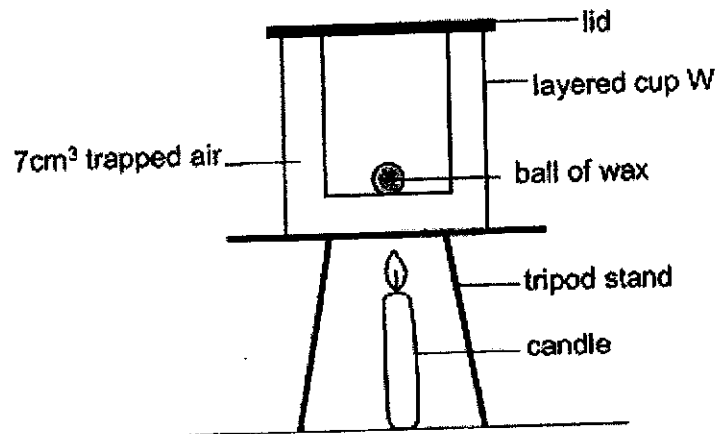

His results are shown in the table below.

amount of trapped air (cm^3)	time taken for the wax to melt completely (s)
7	40
16	100
55	220

- (a) Based on the information above, what is the relationship between the amount of trapped air and the time taken for the wax to melt completely? [1]

Continue on next page

Score	1
-------	---

Continued from previous page

Sam has a roll of bubble wrap as shown below.

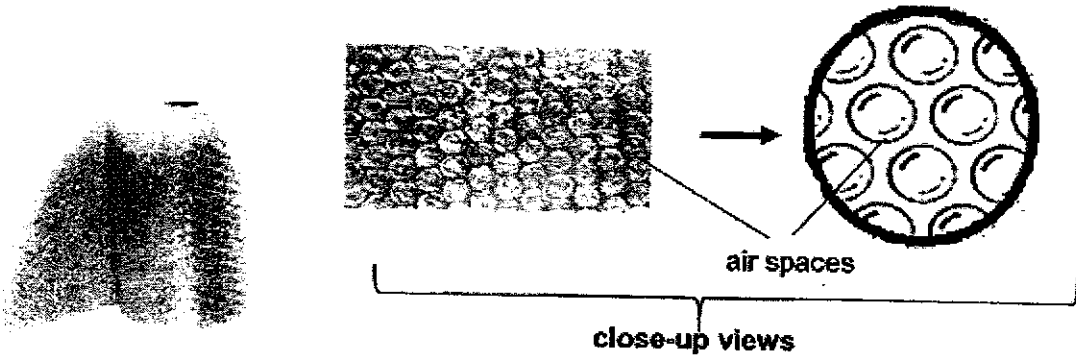

Sam had two identical boxes of hot rice, A and B, at a temperature of 60°C. He wrapped one of the boxes of rice with one layer of bubble wrap and left both boxes on the table as shown in the diagram below.

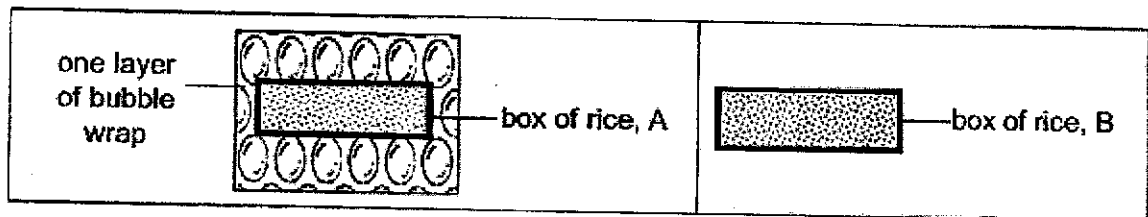

He recorded the change in the temperature of the boxes of rice in the result table below.

box of rice	temperature of box of rice (°C)	
	at first	after 10 minutes
A	60	57
B	60	50

(b) Explain why the box of hot rice, A, in bubble wrap had a smaller decrease in temperature after ten minutes. [2]

(c) Using the same box of hot rice, A at 60°C, as shown in the diagram above, and the roll of bubble wrap, suggest one way Sam could do to keep the box of hot rice, A, warm for a longer time. Explain your answer. [2]

Score	4
-------	---

5. The diagram below shows the different states of water. A, B, C and D represent the processes when water changes from one state to another.

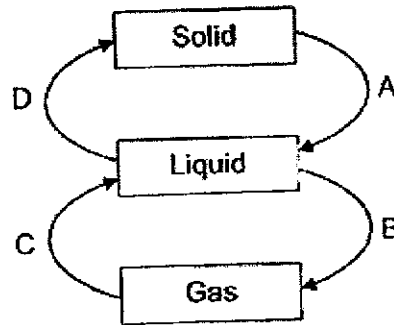

- (a) Identify the processes that takes place at A and B. [1]

Process A: _____

Process B: _____

Observe the set-up below carefully.

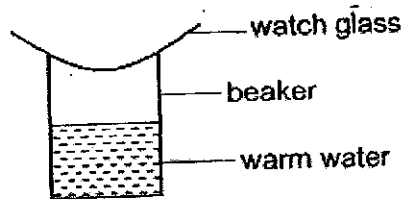

Water droplets were observed on the underside of the watch glass after five minutes.

- (b) Name the process that took place for the above observation. Explain your answer. [2]

Continue on next page

Score	3
-------	---

Continued from previous page

Sarah prepared two identical beakers filled with the same amount of water at 80°C. She covered both beakers with lids as shown in the diagram below.

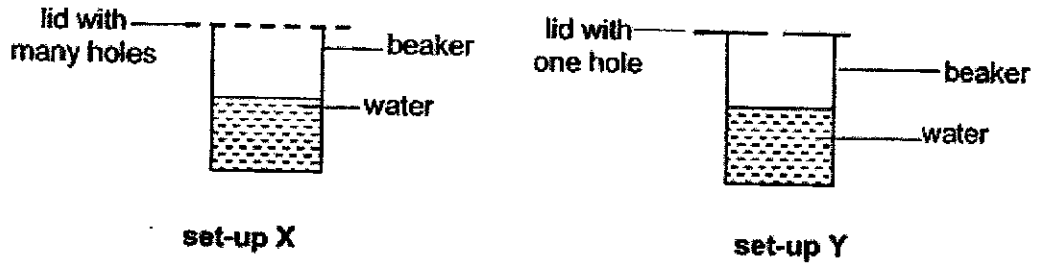

After five minutes, she observed that there was less water in one of the beakers.

- (c) Which set-up, X or Y, would have less water left in the beaker? Explain your answer. [2]

Score	2
-------	---

6. The table below shows the melting and boiling points of four substances, A, B, C and D.

substance	melting point (°C)	boiling point (°C)
A	-114	78
B	0	100
C	113	184
D	221	685

- (a) Based on the information above, write down the states, solid, liquid or gaseous, of substances B and C at 120 °C respectively. [2]

substance	state of substance at 120°C
B	
C	

Amy placed the same amount of substances A, B, C and D on identical dishes. She placed them in a room with a temperature of 30°C. She observed that one of the substances disappeared completely after five minutes.

- (b) Which substance, A, B, C or D, would likely disappear after five minutes? Explain your answer. [2]

End of Paper

Score	4
-------	---

SCHOOL : RAFFLES GIRLS' PRIMARY SCHOOL
LEVEL : PRIMARY 5
SUBJECT : SCIENCE
TERM : WA1

- 1) a) Reproductive System B : R
Reproductive System C : U

b) Both processes involve the fusion of male and female reproductive cells during fertilisation.

c) They both produce the male reproductive cell.

- 2) a) The stigma and anthers of the flower are not hanging out of the flower.

b) Stigma.

c) ~~Yes I agree. The stigma is still present to receive pollen grains from another flower for pollination to occur and result in fertilisation to develop into a fruit.~~

- 3) a) B. After a period of time, the seed leaf will decrease in mass as it supplied food to the seedling for germination. The seedling will grow its true leaves and it does not need to depend on the seed leaves for food.

b) i) The amount of seeds in each set-up.

ii) The height of seedling.

c) A and C

d) The amount of soil.

4) a) The more the amount of trapped air, the longer the time taken for the wax to melt completely.

b) Air is a poor conductor of heat, allowing the box of hot rice to lose heat from its surroundings slower. Hence there is a smaller decrease in temperature after ten minutes.

c) Increase the number of layers of bubble wrap around the rice box. There will be more air spaces that trap more air which to conduct heat from the hot rice to the cooler surrounding air more slowly.

5) a) Process A : Melting
Process B : evaporation

b) Condensation. The warm water gained heat, evaporated and turned into water vapour. The hotter water vapour lost heat and condensed on the cooler inner surface of the watch glass water vapour are formed.

c) Set-up X. When hot water in the beaker evaporated into water vapour, more water vapour comes into contact with the smaller surface area of the cooler lid and condensed into less water droplets to fall back into the beaker.

6) a) B : Gaseous
C : Liquid

b) Substance A. It has the lowest boiling point and thus it will evaporate the fastest.

The temperature difference between the boiling point and the room temperature is the least.