

CAT



RED SWASTIKA SCHOOL

RED SWASTIKA SCHOOL

2004 CONTINUAL ASSESSMENT 1

MATHEMATICS

Name : _____ ()

Class : Primary 6 / ____ (EM 1 / 2)

Date : 2 March 2004

BOOKLET A

15 Questions

25 Marks

Duration of Paper : 2 hours 15 minutes

Note:

1. Do not open this Booklet until you are told to do so.
2. Questions 1 - 15 are to be done on the OAS provided.
3. Read carefully the instructions given at the beginning of each part of the Booklet.
4. Do not waste time. If a question is difficult for you, go on to the next one.
5. Check your answers thoroughly and make sure you attempt every question.

Questions 1 to 5 carry 1 mark each. Questions 6 to 15 carry 2 marks each.

For each question, four options are given. One of them is the correct answer. Make your choice (1, 2, 3 or 4). Shade the correct oval (1, 2, 3 or 4) on the Optical Answer Sheet.

1. Simplify $2y \times y - y - 2 + 9$.

- (1) $2y^2 - y + 7$
- (2) $2y^2 - y - 7$
- (3) $2y^2 - 7$
- (4) $2y^2 + 7$

2. The solid shown in the figure below has _____ faces.

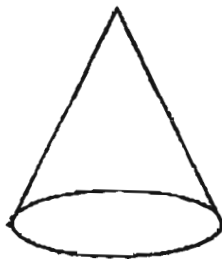

- (1) 1
 - (2) 2
 - (3) 3
 - (4) 4
3. Aminah had 40¢. Ben had \$1.40 more than Aminah. Chitra had 20¢ more than Ben. The ratio of the amount of money that Aminah had to the amount of money that Ben had to the amount of money that Chitra had was _____.
- (1) 1 : 4 : 5
 - (2) 1 : 9 : 5
 - (3) 2 : 4 : 5
 - (4) 2 : 9 : 10
4. David's allowance is half of Sam's allowance. Find the ratio of David's allowance to their total allowance.
- (1) 1 : 2
 - (2) 1 : 3
 - (3) 2 : 1
 - (4) 2 : 3

5. Tom bought two correction tapes for \$7. How much did he have to pay if he had bought 5 correction tapes instead?
- (1) \$15.00
 - (2) \$16.50
 - (3) \$17.50
 - (4) \$22.00
6. The area of a square of side $8w$ cm is _____ cm^2 .
- (1) $64w^2$
 - (2) $64w$
 - (3) $36w^2$
 - (4) $36w$
7. The ratio of the number of Susan's CDs to Fatimah's is 3 : 1. The ratio of the number of Dale's CDs to Fatimah's CDs is 10 : 3. What is the ratio of the number of Susan's CDs to the number of Dale's CDs?
- (1) 1 : 3
 - (2) 1 : 10
 - (3) 3 : 10
 - (4) 9 : 10
8. Kumar has 4m of raffia string. Zack's raffia string is thrice as long as Kumar's. What fraction of the total length of string is Zack's string?
- (1) $\frac{3}{4}$
 - (2) $\frac{2}{3}$
 - (3) $\frac{1}{2}$
 - (4) $\frac{1}{3}$
9. 0.7% express as a decimal is _____.
- (1) 0.7
 - (2) 0.07
 - (3) 0.007
 - (4) 0.0007
10. May spent 80% of her money on a book. If she had \$15, what amount of money had she left?
- (1) \$3
 - (2) \$5
 - (3) \$9
 - (4) \$12

11. If $\frac{2}{3}$ of a number is 8, what is 150% of the number?

- (1) 12
- (2) 15
- (3) 18
- (4) 36

12. Study the figure below carefully.

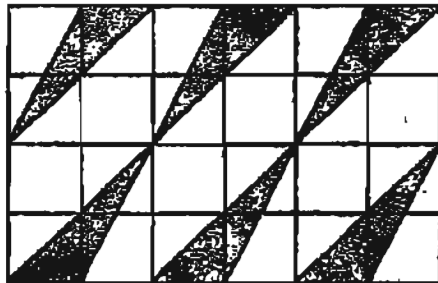

What fraction of the figure is shaded?

- (1) $16\frac{2}{3}\%$ ^{Percentage}
- (2) 25%
- (3) $37\frac{1}{2}\%$
- (4) 50%

13. Mrs Tan and Mrs Lim made some pies. The number of pies that Mrs Tan made was 40% that of Mrs Lim's. If Mrs Lim made 24 more pies than Mrs Tan, find the number of pies that both ladies made.

- (1) 40
- (2) 56
- (3) 60
- (4) 84

14. Peter weighs 60 kg. Sam weighs 25% less than Peter while Mark is 50% of Peter's weight. Find their total weight.

- (1) 105 kg
- (2) 127.5 kg
- (3) 135 kg
- (4) 165 kg

15. The volume of a cube is 512 cm^3 . Its total surface area is _____ cm^2 .

- (1) 64
- (2) 192
- (3) 256
- (4) 384



RED SWASTIKA SCHOOL

RED SWASTIKA SCHOOL

2004 CONTINUAL ASSESSMENT 1

MATHEMATICS

Name : _____ ()

Class : Primary 6 / ____ (EM 1 / 2)

Date : 2 March 2004

BOOKLET B

35 Questions

75 Marks

MARKS

	OBTAINED	POSSIBLE
BOOKLET A		25
BOOKLET B		75
TOTAL		100

Parent's Signature : _____

Questions 16 to 35 carry 1 mark each. Write your answers in the space provided. Give your answers in the units stated.

16. Muthu bought 7 sharpeners and 2 pencils for \$8. If each pencil cost \$ x , find the cost of each sharpener in terms of x .

Ans : \$ _____

17. Study the solid shown below.

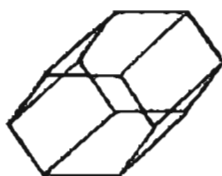

Which of the following nets shows the net of the solid above?

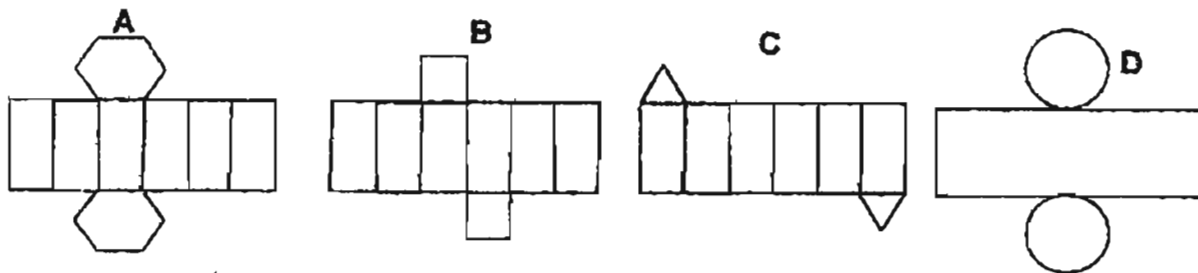

Ans : _____

18. The net of a cube is shown below. The square that is shaded is the *base* of the cube. Put an 'X' on the square that will represent the top of the cube.

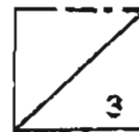
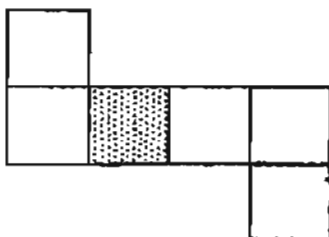

19. Meinua has a box of marbles. $\frac{2}{5}$ of the blue marbles is equal to $\frac{1}{3}$ the number of red marbles. There are 10 more white marbles than red marbles. If she has 112 marbles, how many more white marbles does she have than blue marbles?

Ans : _____

20. Mrs Tan divided some stamps among her sons. The ratio of Ray's stamps to Sam's stamps is 5 : 3. The ratio of Sam's stamps to Ted's stamps is 8 : 15. Find the ratio of Ray's stamps to Sam's stamps to Ted's stamps in the simplest form.

Ans : _____

21. Tim walked 3 times round a rectangular field measuring 65 m by 40 m. If he walked at a rate of 15 metres per minute, how long did he take?

Ans : _____ minutes

22. In the year 2003, the ratio of the number of boys to the number of girls in Red Swastika School was 3 : 7. One year later, 40 more boys joined the school and the ratio of the number of boys to the number of girls became 10 : 21. How many boys were there at first?

Ans : _____

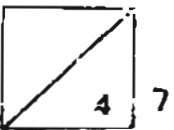

23. The ratio of the number of fighting fish in Tank A to Tank B was 2 : 5. When some fighting fish in Tank B died, the ratio of the number of fighting fish in Tank A to Tank B became 3 : 5. If there were 42 fighting fish at first, how many fighting fish died?

Ans : _____

24. The ratio of the number of sweets Ravi had to the number of sweets that Irene had was in the ratio 3 : 8. When Irene gave Ravi 15 sweets, they had the same number of sweets. How many sweets did Ravi had at first?

Ans : _____

25. Study the diagram below carefully.

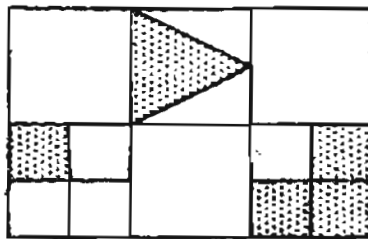

Find the ratio of the shaded part of the figure to the unshaded part of the figure.
Express your answer in the simplest form.

Ans : _____

26. 60% of a number is 168. What is the number?

Ans : _____

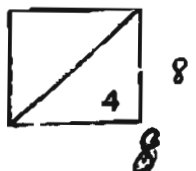

27. Express $8\frac{1}{2}\%$ as a decimal.

Ans : _____

28. How many more squares should be shaded so that the number of shaded squares is 64% of the total number of squares?

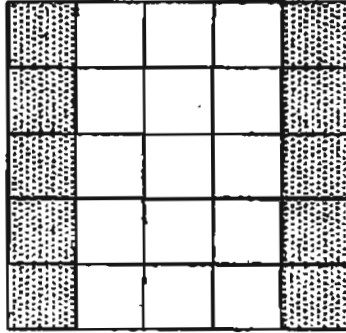

Ans : _____

29. There are 20% more dogs than cats in the SPCA. How many cats are there if 60 of the animals are dogs?

Ans : _____

30. Find the value of 28% of 4 kg.

Ans : _____ kg, _____ 8

31. The average of 4 numbers is 12. If three of the numbers are 7, 8 and 20, find ^{the} fourth number.

Ans : _____



32. Evaluate $(47 + 37) \div 4 - 3 \times 2$.

Ans : _____

33. Find the volume of a cube if the area of one face is 16 cm^2 .

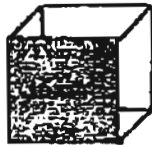

Ans : _____ cm^3

34. Arrange the following decimals in ascending order.

0.10, 0.095, 0.28, 0.101

Ans : _____

35. What is the missing number in the blank below?

$$6.5 \times 12 = 6.4 \times 12 + \underline{\quad} \times 12$$

Ans : _____



For Questions 36 to 50, show your workings clearly in the space below each question and write your answers in the space provided.

The number of marks for each question is shown in brackets [] at the end of each question or part-question.

36. Ron bought himself a soccer ball, a basketball and a shoe bag. The soccer ball cost $2\frac{1}{2}$ times as much as a basketball. The ratio of the cost of the shoe bag to the cost of the soccer ball was 3 : 10. If the total cost of what he bought was \$136, find the cost of the soccer ball.

Ans : _____ [2]

37. For every 3 white roses that a florist had, she had 4 red ones. For every 9 red roses that she had, she had 5 pink ones. If she had a total of 249 roses, how many red roses did she have?

Ans : _____ [2]

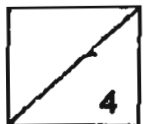

38. 30% of Amy's money is equal to 40% of Gina's money. If Gina has \$50 less than Amy, how much does Amy have?

Ans : _____ [2]

39. Square A has a side of q cm. The area of Square B is 6 cm^2 less than that of Square A.

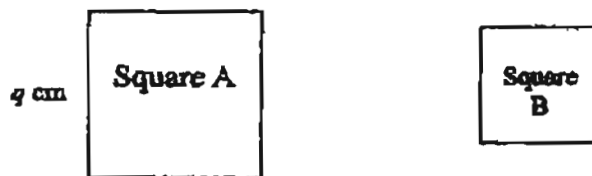

- (a) Find the area of Square B in terms of q .
(b) If $q = 8$, find the area of Square B.

Ans : (a) _____ [2]

Ans : (b) _____ [1]

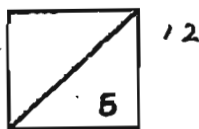

40. Sarah spent $\frac{1}{5}$ of her money on a skirt and a blouse. Her skirt cost twice as much as her blouse. She then had \$96 left. How much did she spend on her blouse?

Ans : _____
[3]

41. The figure below is not drawn to scale. ABCD is a parallelogram and XCB is an isosceles triangle. XD is a straight line.

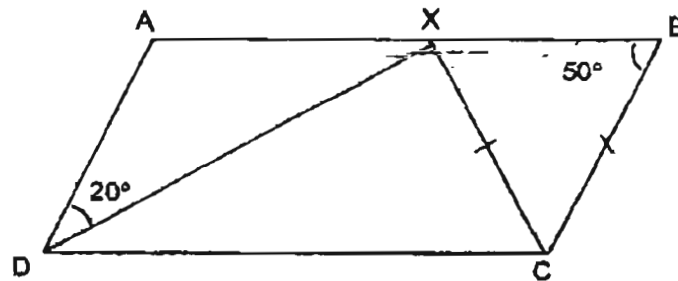

- (a) Which angle is equal to $\angle BCD$?
(b) Find $\angle CXD$.

Ans : (a) _____ [1]

Ans : (b) _____ [2] 13



Janice had some buttons. For every 9 white buttons that she had, there were 4 yellow buttons. After she used 8⁹ white buttons for a skirt, the ratio of white buttons to yellow buttons became 3: 2. How many buttons were left?

Ans : _____ [4]

43. Peter gives his parents 40% of his monthly salary and keeps the remainder for himself. If he spends 80% of his remaining salary and saves \$180, how much does he give to his parents?

Ans : _____ [4]

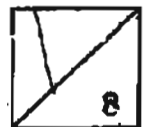

14

14

44. There are 3 tanks, each containing some water. Tank X has 40% more water than Tank Y. Tank Z contains 75% of the amount of water in Tank Y. The total volume of water in tanks Y and Z is 350 ml. What is the volume of water in Tank Z?

45. Tap A can fill up a pond in 4 hours while Tap B can fill up the same pond in 6 hours.

(a) What fraction of the pond can Tap B fill in 1 hour?

(b) If both taps are turned on at the same time, how long will it take for both taps to fill up the pond? (Express the time taken in hours and minutes.)

Ans : (a) _____ [1]

Ans : (b) _____ [3]

46. The diagram below is not drawn to scale.

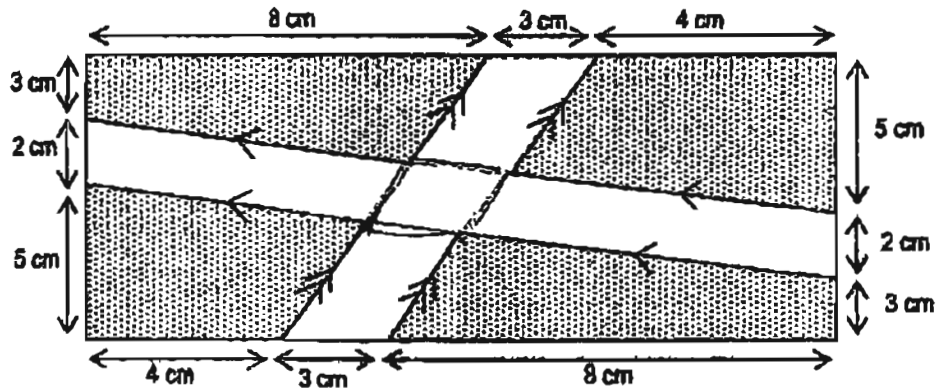

- (a) Find the area of the shaded part.
- (b) Find the area of the unshaded part.

Ans : (a) _____ [2]

Ans : (b) _____ [2]



47. A rectangular tank contains water to a height of 5 cm. 18 cubes of volume 64 cm^3 each were placed in the tank and were submerged in the water.

The ratio of the length to the breadth to the height of a tank is $5 : 2 : 4$ respectively. The perimeter of the base of the tank is 84 cm.

- (a) What is the volume of the tank?
- (b) What is the height of the water level after the 18 cubes have been put into the tank?

Ans : (a) _____ [2]

Ans : (b) _____ [3]

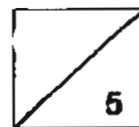

48. There are some pencils in Boxes A, B and C. The ratio of the number of pencils in Box A to that in Box B to that in Box C is $2 : 3 : 6$ respectively. When 4 pencils were transferred from Box C to Box B, the ratio became $4 : 7 : 11$. Find the total number of pencils in the 3 boxes.

Ans : _____ [5]

19

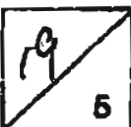

49. Ann booked a tour package at a discount of 25% for \$2625. Ken booked the same tour package at a travel fair and was given a discount of \$980.

- (a) What was the percentage discount given to Ken?
- (b) What was the difference in the percentage discount given to Ann and Ken?

Ans : (a) _____ [4]

Ans : (b) _____ [1]

20

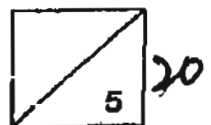

50. In January, 30% of the 40 pupils in the Botany Club ^{were} girls while the rest were boys. When a few girls left the club in June, the percentage of girls decreased to 20%. How many girls left the Botany Club?

Ans : _____ [5]

~ Please check your work carefully ~
End of paper

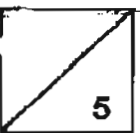

21

21

RED SWASTIKA SCHOOL
 2004 CONTINUAL ASSESSMENT 1
 MATHEMATICS
 PRIMARY 6

CAT

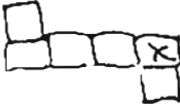
- | | | |
|---|---------------------------------|----------------------------|
| 1) 1 | 25) 1 : 3 | 47) a) 8640 cm^3 |
| 2) 2 | 26) 280 | b) 8.2 cm |
| 3) 4 | 27) 0.085 | 48) 88 pencils |
| 4) 2 | 28) 6 | 49) a) 28% |
| 5) 3 | 29) 50 | b) 3% |
| 6) 1 | 30) 1 kg 120 g | 50) 5 girls |
| 7) 4 | 31) 13 | |
| 8) 1 | 32) 15 | |
| 9) 3 | 33) 64 | |
| 10) 1 | 34) 0.095, 0.10, 0.101, 0.28 | |
| 11) 3 | 35) 0.1 | |
| 12) 2 | 36) \$ 80 | |
| 13) 2 | 37) 108 red roses | |
| 14) 3 | 38) \$ 200 | |
| 15) 4 | 39) a) $(q^2 - 6) \text{ cm}^2$ | |
| 16) $(\frac{8-2x}{7})$ | b) 58 cm^2 | |
| 17) A | 40) \$ 8 | |
| 18) | 41) a) Angle DAB | |
|  | b) 100° | |
| 19) 16 marbles | 42) 30 buttons | |
| 20) 40 : 24 : 45 | 43) \$ 600 | |
| 21) 42 | 44) 150 ml | |
| 22) 360 boys | 45) a) $\frac{1}{6}$ | |
| 23) 10 fishes | b) 2 hour 24 minutes | |
| 24) 18 | 46) a) 96 cm^2 | |
| | b) 54 cm^2 | |