



Rosyth School
Preliminary Examination 2011
Primary 6 Mathematics

Name: _____ Register No: _____

Class: _____

Date: 23 Aug 2011

Parent's Signature: _____

Total Time for Booklets A and B : 50 min

PAPER 1
(Booklet A)

Instructions to Pupils:

1. Do not open this booklet until you are told to do so.
2. Follow all instructions carefully.
3. Shade your answers in the Optical Answer Sheet (OAS) provided.
4. You are not allowed to use a calculator
5. Answer all questions.

Section	Maximum Mark	Marks Obtained
Paper 1 (Booklet A)	20	

* This booklet consists of 7 pages (excluding this cover page)

This paper is not to be reproduced in part or whole without the permission of the Principal.

Questions 1 to 10 carry 1 mark each. Questions 11 to 15 carry 2 marks each. For each question, four options are given. One of them is the correct answer. Make your choice (1, 2, 3 or 4). Shade the oval (1, 2, 3 or 4) on the Optical Answer Sheet.

(20 marks)

1 The number of people who attended an exhibition is 369 382.
Express this number to the nearest thousand.

(1) 360 000

(2) 370 000

(3) 369 000

(4) 400 000

2 Express 9 hundreds, 8 tens, 9 tenths and 8 hundredths as a decimal.

(1) 908.98

(2) 909.89

(3) 980.89

(4) 980.98

3 Find the value of $80 - 15 \div 5 + 4 \times 3$.

(1) 25

(2) 51

(3) 89

(4) 243

4 Find the value of $\frac{5}{7} \div 35$.

(1) $\frac{1}{49}$

(2) $\frac{1}{25}$

(3) 25

(4) 49

5 The capacity of a rectangular tank is 4.2 litres. It has a base area of 600 cm^2 .
What is its height?

(1) $\frac{1}{7} \text{ cm}$

(2) $\frac{1}{70} \text{ cm}$

(3) $\frac{7}{100} \text{ cm}$

(4) 7 cm

6 Which of the following is the same as 6 030g ?

(1) 6 kg 3g

(2) 6 kg 30g

(3) 60 kg 3g

(4) 60 kg 30 g

- 7 In the diagram below, the figures are drawn on a square grid. How many figures have a line of symmetry?

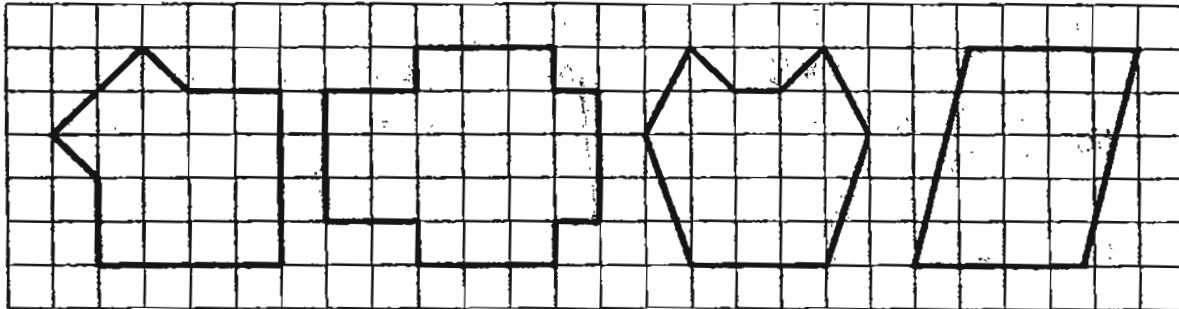

- (1) 1
- (2) 2
- (3) 3
- (4) 4

- 8 Mrs Tan parked her car in a car park from 07 45 to 10 30 on the same day. The parking fee is as shown in the table below. *2 h 45 min*
How much did she pay for the parking fee?

Parking Charges	
For the 1 st hour	\$2.50
For every subsequent $\frac{1}{2}$ hour or part thereof	\$0.80

- (1) \$3.30
- (2) \$4.10
- (3) \$4.90
- (4) \$5.70

9 The average of 3 numbers is $3y$. One of the numbers is y and another number is 5. Express the third number in terms of y in the simplest form.

(1) $8y - 5$

(2) $2y - 5$

(3) $3y$

(4) $4y$

10 These 4 solids below are formed by identical cubes which are glued together.

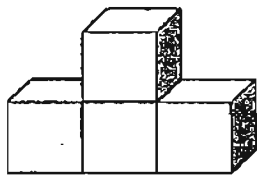

A

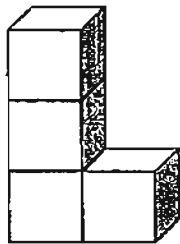

B

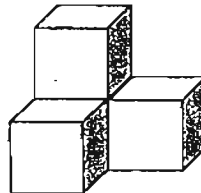

C

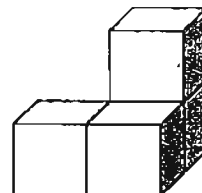

D

Which two solids can be joined to form the solid shown below?

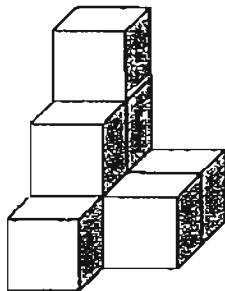

(1) A & C

(2) B & C

(3) A & D

(4) B & D

- 11 What fraction of the regular hexagon is shaded?

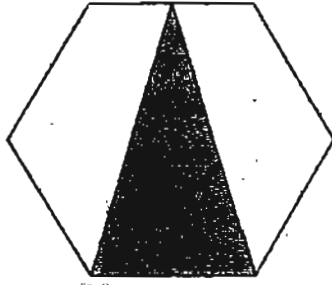

- (1) $\frac{1}{6}$
- (2) $\frac{1}{3}$
- (3) $\frac{2}{5}$
- (4) $\frac{1}{2}$
- 12 Chris had some M&M's chocolates. He gave $\frac{3}{10}$ of them to Keagan and $\frac{2}{5}$ of the remainder to Kumar. He had 105 left. How many M&M's chocolates had Chris at first?
- (1) 210
- (2) 250
- (3) 350
- (4) 375

- 13 In the figure, PQR is a straight line and $TP = TQ$. Find $\angle x$.

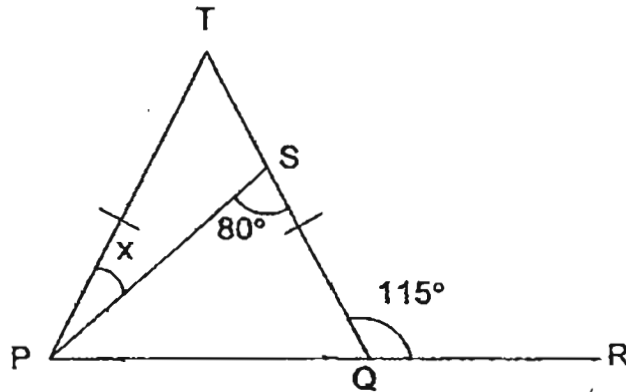

- (1) 15°
- (2) 30°
- (3) 35°
- (4) 40°
- 14 Harry jogs at 140 m/min for 1 hour daily. If he brisk walks at 80 m/min , how many minutes **more** will he take to complete the same distance?
- (1) 45 min
- (2) 60 min
- (3) 90 min
- (4) 105 min

- 15 Triangle XYZ is a right-angled triangle. The quadrant and the 2 parts of a circle have the same radius. Find the unshaded area in the figure. (Take $\pi = \frac{22}{7}$)

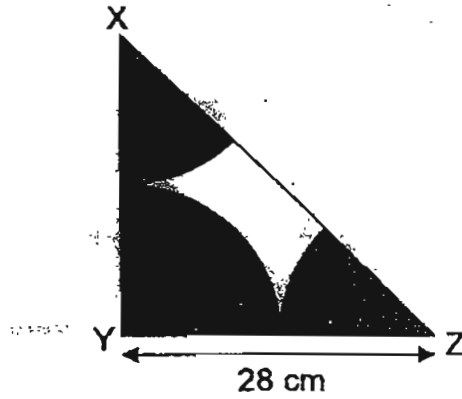

- (1) 84 cm^2
(2) 168 cm^2
(3) 308 cm^2
(4) 700 cm^2



**Rosyth School
Preliminary Examination 2011
Primary 6 Mathematics**

Name: _____ Register No. _____

Class: Pr 6 - _____

Date: 23 Aug 2011

Parent's Signature: _____

Total Time for Booklets A and B : 50 min

**PAPER 1
(Booklet B)**

Instructions to Pupils:

1. Do not open this booklet until you are told to do so.
2. Follow all instructions carefully.
3. You are **not** allowed to use a calculator
4. Answer all questions.

Section	Maximum Mark	Marks Obtained
Paper 1 (Booklet B)	20	

* This booklet consists of 7 pages (excluding this cover page)

This paper is not to be reproduced in part or whole without the permission of the Principal.

Questions 16 to 25 carry 1 mark each. Write your answers in the spaces provided. For questions which require units, give your answers in the units stated.

Do not write in this space

(10 marks)

16. Write down all the common factors of 9 and 36.

Ans: _____

17. Evaluate $4\frac{1}{4} - 1.42$, leave your answer as a decimal.

Ans: _____

18. Rearrange the following numbers in ascending order.

0.3 , 0.09 , $\frac{3}{11}$, $\frac{3}{8}$

Ans: _____

Do not write
in this space

19. Express $4\frac{2}{5}$ h in minutes.

Ans: _____ min

20. Three friends stood in the following arrangement:

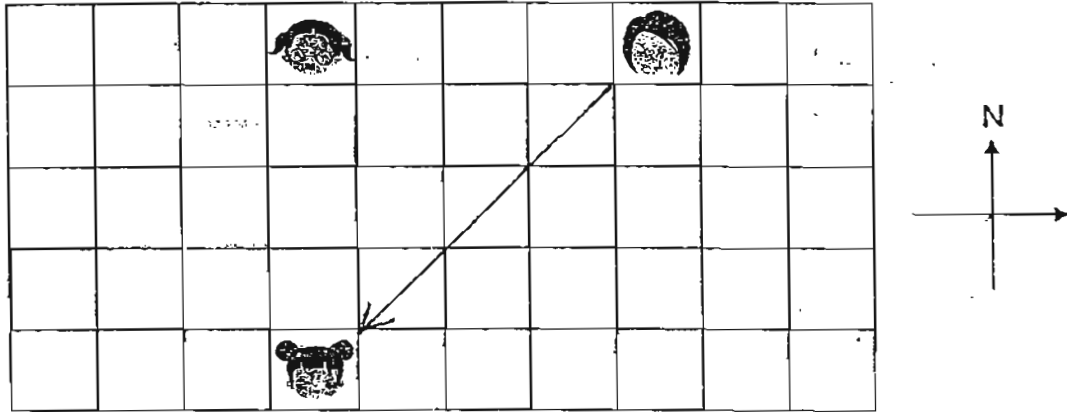

Susan is standing North of Li Xing and West of Mandy.
In which direction should Mandy walk towards Li Xing?

Ans: _____

21. A gardener wants to fence a square plot of land. He used 6 posts on each side. How many posts did he use altogether?

Ans: _____

22. The lights on three lightships flash at regular intervals. The first light flashes once every 4 ~~seconds~~^{minutes}, the second light flashes once every 5 ~~seconds~~^{minutes} and the third light flashes once every 8 ~~seconds~~^{minutes}. If the three lights flash together at 07 00, at what time will they next flash together?
Give your answer in 24-hour clock.

Do not write
in this space

Ans: _____

23. $\frac{2}{3}$ of Avin's height is equal to $\frac{3}{10}$ of Leo's height.

Find the ratio of Alvin's height to Leo's height.

Ans: _____

24. The figure below shows a cube.

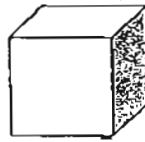

Do not write
in this space

Mark with an 'X' on a square to complete the net of the cube.

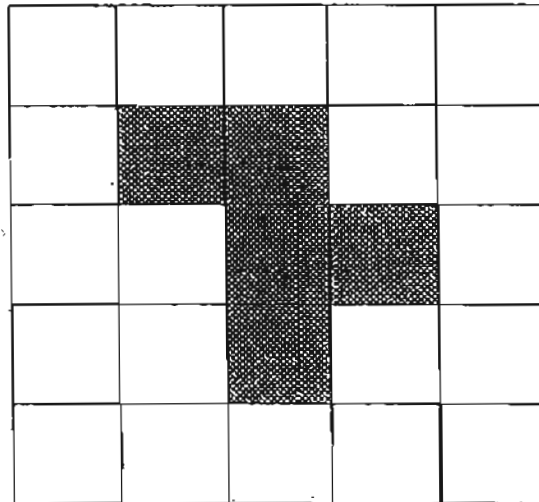

25. The pattern in the box shows a part of a tessellation. Extend the tessellation by drawing 2 more unit shapes in the space provided within the box.

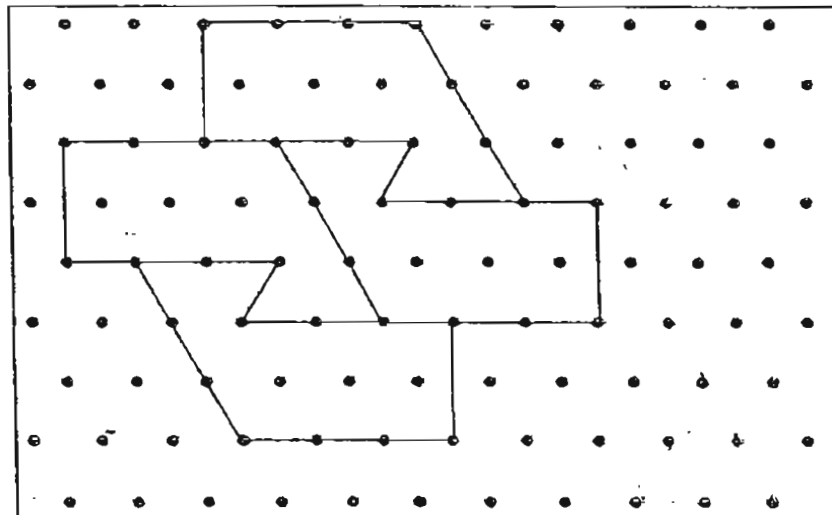

Questions 26 to 30 carry 2 marks each. Show your workings clearly in the space provided for each question and write your answers in the spaces provided. For questions which require units, give your answers in the units stated.

Do not write in this space

(10 marks)

26. If today is Tuesday, what day will it be in 100 days' time?

Ans: _____

27. In the figure, AGED is a parallelogram. ACD and DFE are triangles. Given that $\angle FGB = 70^\circ$, $\angle ACD = 30^\circ$ and $\angle BDA = 30^\circ$, find $\angle HDB$.

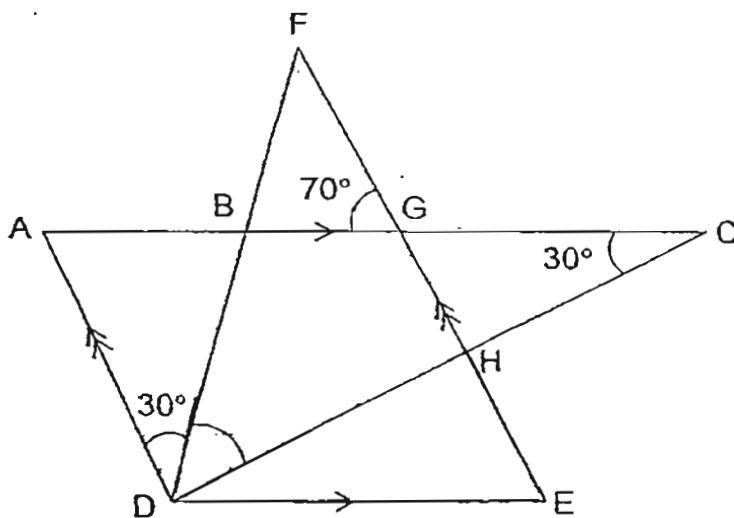

Ans: _____

28. A rectangular field measures 20 metres by y metres is surrounded by grass patch of width 2 metres. What is the area of the grass patch? Leave your answer in the simplest form in terms of y .

Do not write in this space

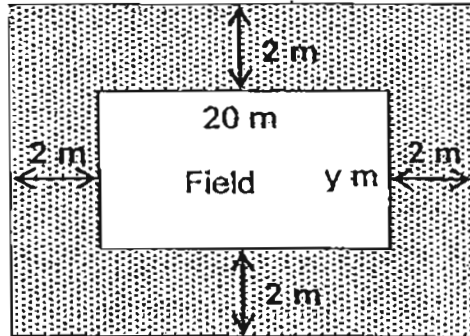

Ans: _____ m^2

29. The diagram below is made up of a quarter-circle and a three-quarter circle with centre O . Find the perimeter of the figure. (Leave your answer in terms of π)

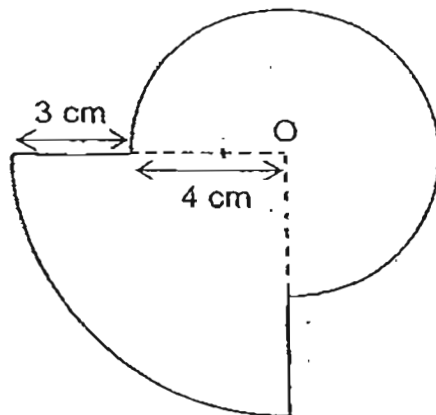

Ans: _____ cm

30. A group of Primary 1 pupils were asked to vote for their favourite colour. The results were represented in the pie chart below.

Do not write
in this space

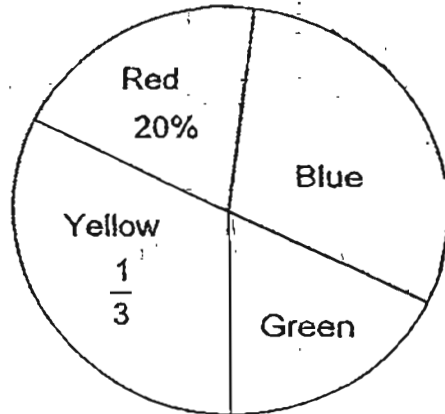

Half the number of pupils chose red and blue colour. If 8 more pupils choose blue than green colour, how many chose red colour?

Ans: _____

End of Paper 1



Rosyth School
Preliminary Examination 2011
Primary 6 Mathematics

Name: _____ Register No. _____

Class: Pr 6 - _____

Date: 23 Aug 2011

Parent's Signature: _____

Time: 1 h 40 min

PAPER 2

Instructions to Pupils:

1. Do not open this booklet until you are told to do so.
2. Follow all instructions carefully.
3. **Show your workings clearly** as marks are awarded for correct working.
4. Write your answers in this booklet.
5. You are allowed to use a calculator.
6. Answer all questions.

Questions	Maximum Mark	Marks Obtained
Q 1 to 5	10	
Q 6 to 18	50	

Section	Maximum Mark	Marks Obtained
Paper 1	40	
Paper 2	60	
Total	100	

* This booklet consists of 16 pages (excluding this cover page)

This paper is not to be reproduced in part or whole without the permission of the Principal.

Questions 1 to 5 carry 2 marks each. Show your working clearly in the space provided for each question and write your answers in the spaces provided. For questions which require units, give your answers in the units stated.

Do not write in this space

(10 marks)

1. The graph below shows the total distance Sam jogged yesterday over a period of time. What was Sam's average speed for the whole journey?

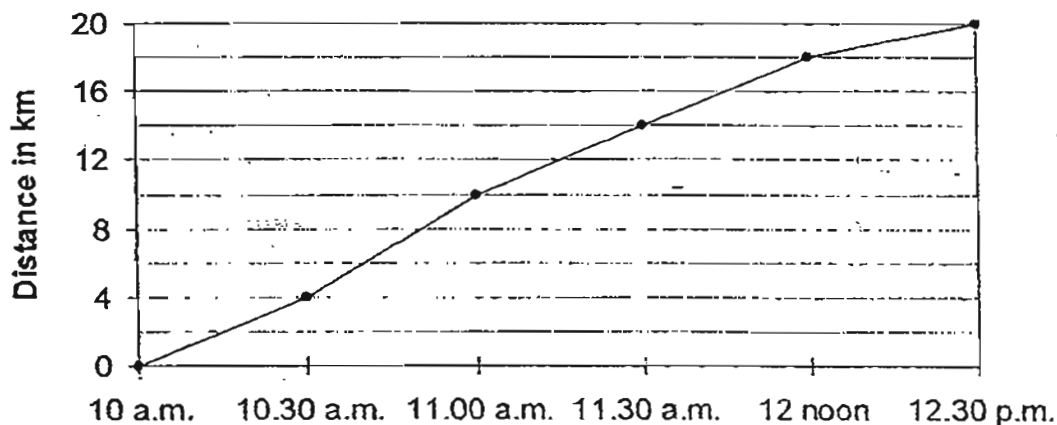

Answer: _____ km/h [2m]

2. A ball was dropped from a certain height. Each time it touched the ground, it bounced to a height which was $\frac{1}{3}$ of the height from which it was dropped. Given that it reached a height of 1.54 m on the third bounce, find the height at which it was dropped at first?

Answer: _____ [2m]

3. Find the perimeter of the figure below.

Do not write
in this space

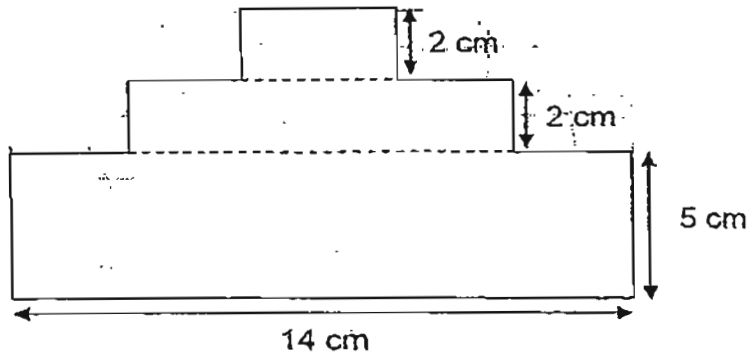

Answer: _____ cm [2m]

4. The pie chart below shows the number of computers sold in a company from July to ~~September~~^{October}. An equal number of computers were sold in July and in August. The ratio of the number of computers sold in August to the number of computers sold in October is 3 : 2. If 480 computers were sold in the 4 months, how many computers were sold in September?

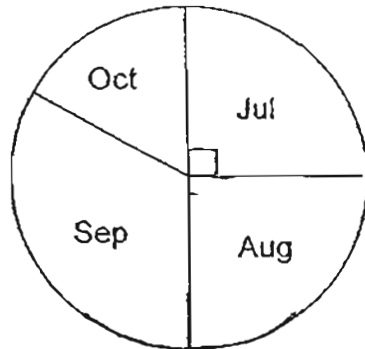

Answer: _____ [2m]

5. The figure below shows 2 overlapping rectangles A and B. The area of rectangle B is 20% more than the area of rectangle A. The unshaded area of rectangle A is 80% of the unshaded area of rectangle B. What percentage of rectangle B is shaded?

Do not write
in this space

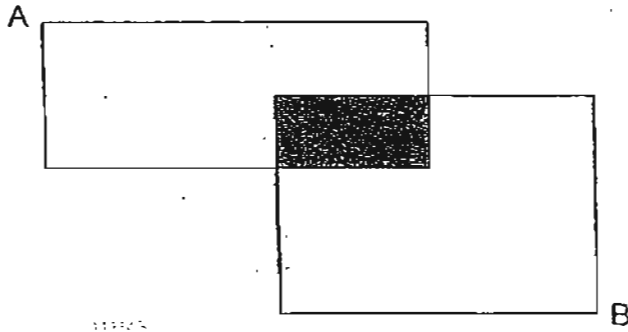

Answer: _____ [2m]

Questions 6 to 18, show your working clearly in the space provided for each question and write your answers in the spaces provided. The number of marks available is shown in brackets [] at the end of each question or part-question.

Do not write
in this space

(50 marks)

-
6. Velu and Rosie had some stamps. If Velu gave Rosie 52 stamps, she would have the same number of stamps as Rosie. If Rosie gave Velu 34 stamps, the ratio of the number of stamps Rosie had to the number of stamps Velu had will be 3 : 7. How many stamps did Velu have at first?

Answer: _____ [3m]

7. Mrs Tan baked some cheese muffins and some chocolate muffins. After she sold $\frac{1}{3}$ cheese muffins and $\frac{3}{5}$ of the chocolate muffins, she had twice as many cheese muffins than chocolate muffins left. If Mrs Tan baked 50 more cheese muffins than chocolate muffins, find the total number of muffins Mrs Tan baked.

Do not write
in this space

Answer: _____ [3m]

8. The figure below is formed by 3 semi-circles. AB is a straight line of 46 cm. Find the perimeter of the figure. Leave your answer in terms of π .

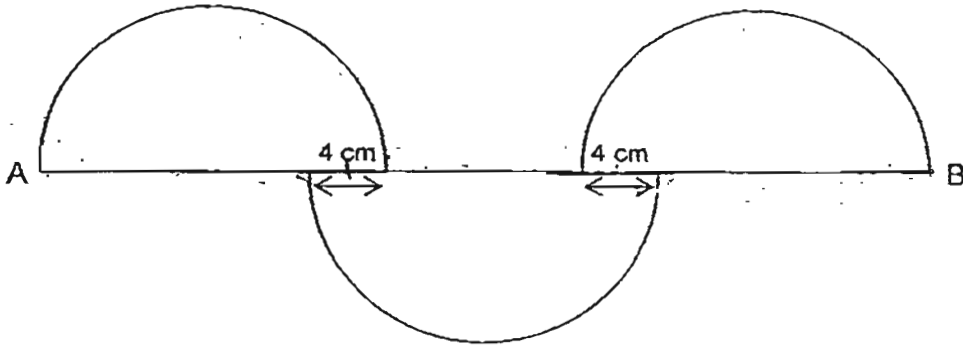

Do not write
in this space

Answer: _____ [3m]

9. The graph below shows the number of SMS and calls made by Cindy through her mobile phone over a 5-day period. Study the graph carefully and answer the questions.

Do not write in this space

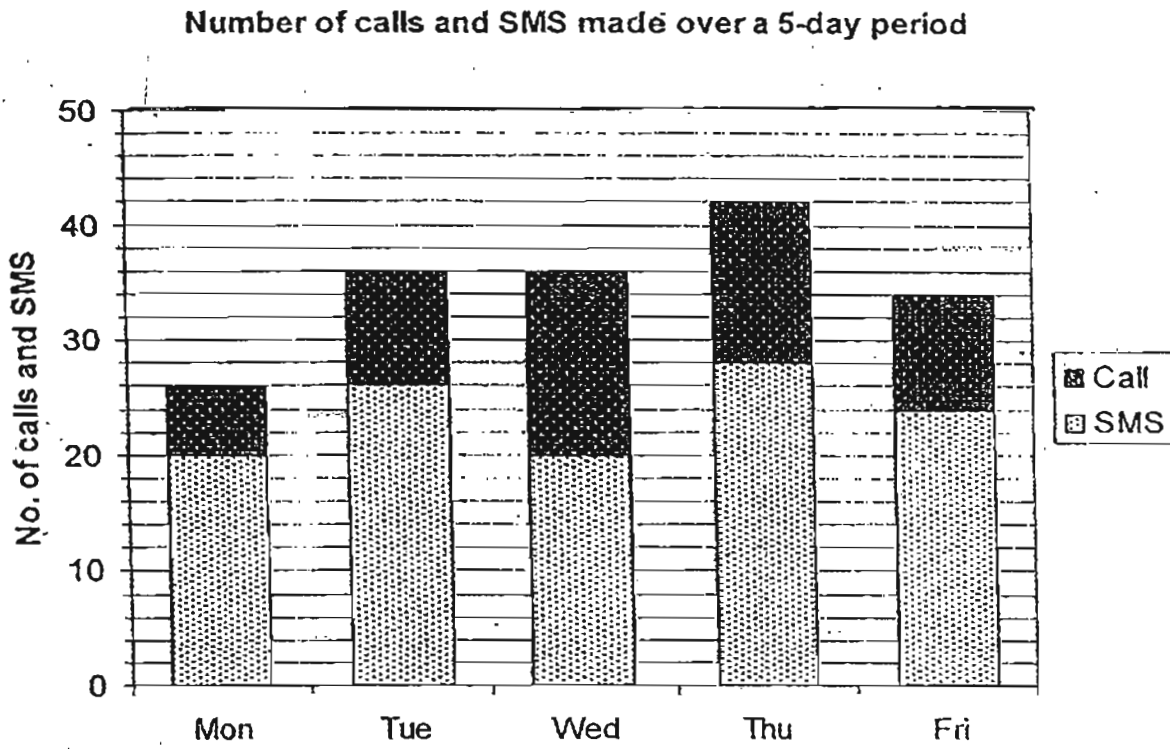

- (a) On which two days were the number of calls made the same?
- (b) On which day was the ratio of the number of calls made to the number of SMS made 1 : 2 ?
- (c) Find the total number of calls and SMS Cindy made over the 5-day period.

Answer: (a) _____ and _____ [1m]

(b) _____ [1m]

(c) _____ [1m]

10. In the figure below, ABCD is a square, $DC = DE$, AFE and BFD are straight lines. Given that $\angle AFB$ is 103° , find $\angle FDE$.

Do not write
in this space

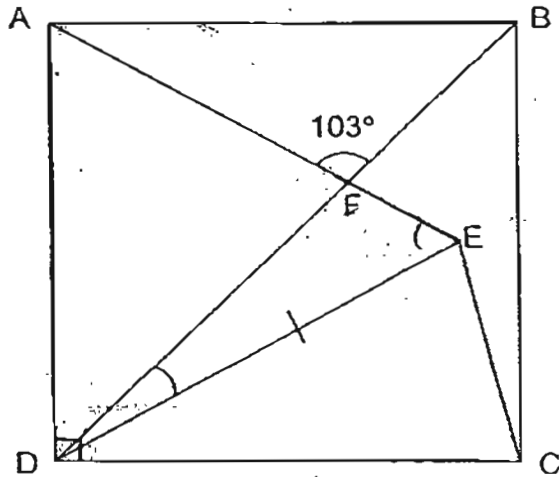

Answer: _____ [3m]

11. Charlene had some sweets and chocolates in a bag. If she ate one sweet, the ratio of the number of sweets to the number of chocolates left in the bag would be 2 : 3. If she ate one chocolate, the ratio of the number of sweets to the number of chocolates left in the bag would be 7 : 10. What was the ratio of the number of sweets to the number of chocolates Charlene had in the bag?

Do not write
in this space

Answer: _____ [3m]

12. Mr Tan had some apples and oranges in the ratio $4 : 5$. After selling 170 apples and 25% of the oranges, the ratio of the apples to oranges left became $1 : 2$.
What was the number of fruits Mr Tan had in the end?

Do not write
in this space

Answer: _____ [4m]

13. A confectionery factory baked a total of 3 123 cupcakes in 4 different flavours, Strawberry, Chocolate, Vanilla and Blackforest. The Blackforest flavour was the most popular and Vanilla was the least popular flavour with a difference of 528. The difference in the number of cupcakes between Strawberry flavour and Blackforest flavour was 351. The difference in the number of cupcakes between the Chocolate-flavour and Blackforest flavour was 190.

Do not write
in this space

- (a) How many Blackforest-flavour cupcakes were baked?
- (b) The cupcakes were packed into boxes for delivery. Each box can hold up to 20 cupcakes. What is the minimum number of boxes needed to pack all the Strawberry-flavour and Vanilla-flavour cupcakes?

Answer: (a) _____ [2m]

(b) _____ [3m]

14. Elijah and Abdul shared a sum of money. $\frac{1}{4}$ of Elijah's share is \$625 more than 10% of Abdul's share. If they had a total of \$15 100, what percentage of the sum of money is Elijah's share? (Give your answer correct to 1 decimal place).

Do not write
in this space

Answer: _____ [4m]

15. Two rectangular tanks A and B measures 40 cm by 20 cm by ~~30 cm~~ ^{40 cm} and 50 cm by ~~30 cm~~ ^{40 cm} by 45 cm respectively. Water is being filled by Tap P and Q at a rate of 1.2 litres/min and 5 litres/min in Tank A and Tank B respectively.

At 8 a.m., Tap P was turned on first.

- (a) What is the height of the water level in Tank A after 10 minutes?
- (b) At 8.10 a.m., Tap Q was then turned on. At what time will the height of the water level in both tanks equal?

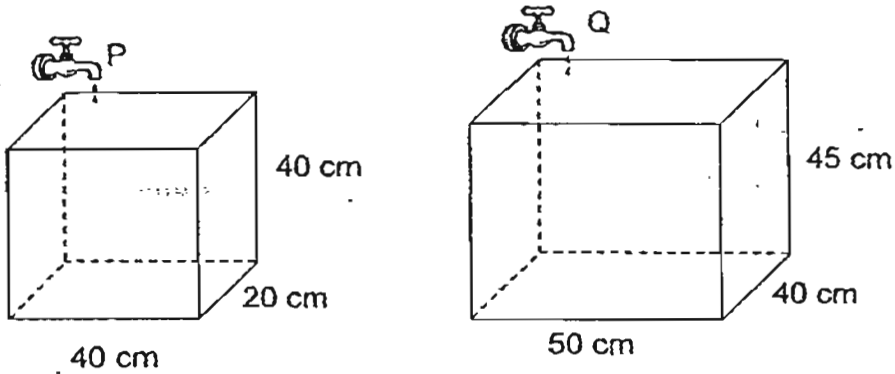

Do not write in this space

Answer: (a) _____ [2m]

(b) _____ [3m]

16. Michelle had 60% more cards than Adila. Usha had 35% fewer cards than Michelle. Michelle and Adila gave Usha some cards in the ratio of 3 : 1. As a result, Usha had $1\frac{1}{2}$ times as many cards as before. Given that Michelle had 238 more cards than Adila in the end, how many cards did Michelle give to Usha?

Do not write
in this space

Answer: _____ [5m]

17. The figure below is made up of 3 circles with the same radius 10 cm. X, Y and Z are the centres of the circles respectively. For each of the following, use the calculator value of π to find
- (a) the perimeter of the shaded parts, correct to 2 decimal places,
 - (b) the area of the shaded parts, correct to 2 decimal places.

Do not write
in this space

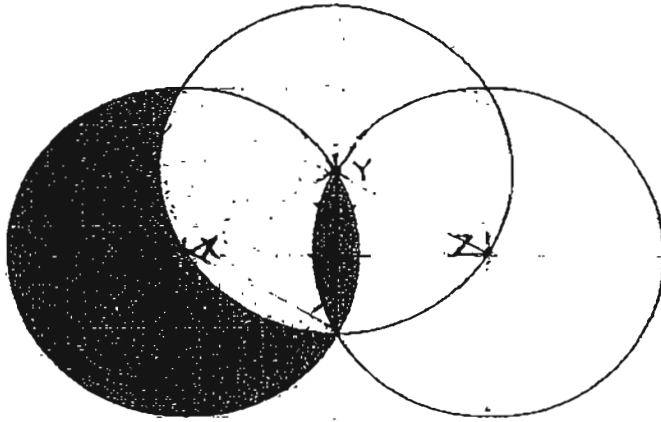

Answer: (a) _____ [2m]

(b) _____ [2m]

18. Abdul, Bernard and Chi Hao were all standing in a straight line waiting for the race to start. Chi Hao was 300 m ahead of Bernard and Bernard was 100 m ahead of Abdul. At 9 a.m., they started the race. Abdul overtook Bernard in 5 mins. In another 5 mins, Abdul overtook Chi Hao. If Bernard's speed is 150 m/min, at what time did Bernard overtake Chi Hao?

Do not write
in this space

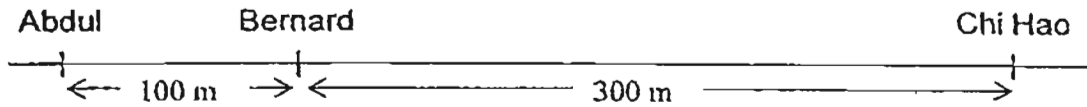

Answer: _____ [5m]

End of Paper

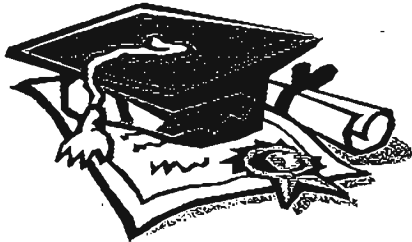

ANSWER SHEET

EXAM PAPER 2011

SCHOOL : ROSYTH
SUBJECT : PRIMARY 6 MATHEMATICS

TERM : PRELIMINARY

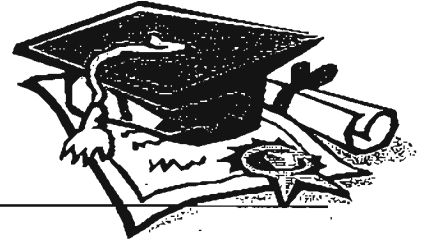

Q1	Q2	Q3	Q4	Q5	Q6	Q7	Q8	Q9	Q10	Q11	Q12	Q13	Q14	Q15
3	4	3	1	4	2	3	4	1	2	2	2	2	1	1

16) 1, 3, 9

17) 2.83

18) 0.09, 3/11, 0.3, 3/8

19) 264 min

20) South-West

21) 20 posts

22) 0740

23) 9:20

24)

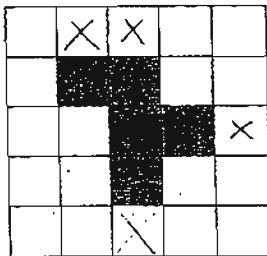

25)

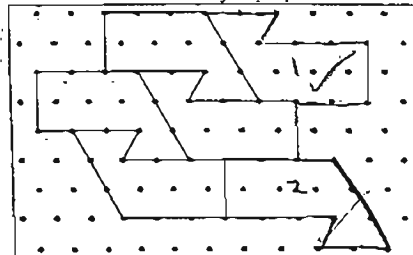

26) Thursday

27) 50°

28) $(4y+96)$

29) $(9.5\pi+6)$

30) 12 pupils

Paper 2

1) 10am \rightarrow 12.30pm

$$20 \div 2\frac{1}{2} = 20 \times \frac{2}{5} = 8$$

Sam's average speed was 8km/h

2) $3 \times 3 \times 3 = 27$

$$27 \times 1.54 = 41.58\text{m}$$

3) $5 + 2 + 2 = 9$

$$(14+9) \times 2 = 23 \times 2 = 46$$

The perimeter is 46cm.

4) July $\rightarrow \frac{1}{4} \times 480 = 120$

$$\text{Oct} \rightarrow \frac{2}{3} \times 120 = 80$$

$$\text{Sep} \rightarrow 480 - 80 - 120 - 120 = 160$$

$$\text{Or) Sep} \rightarrow 120 \times 2 - 80 = 160$$

160 computers were sold in September.

5) shaded $\rightarrow 5u - 4u = 1u$

$$6u - 5u = 1u$$

$$1u/6u \times 100\% = 16\frac{2}{3}\%$$

$16\frac{2}{3}\%$ of rectangle B is shaded

6) $5u - 52 \rightarrow 3u + 34$ (R at first)

$$5u - 3u \rightarrow 34 + 52$$

$$2u \rightarrow 86$$

$$1u \rightarrow 86 \div 2 = 43$$

$$5u \rightarrow 43 \times 5 = 215$$

$$215 + 52 = 267 \text{ stamps.}$$

7) $1 - 1/3 = 2/3$ (cheese left)

$1 - 3/5 = 2/5$ (choc left)

$2/3$ cheese $\rightarrow 2/5$ choc $\times 2 = 4/5$ choc

$4/6$ cheese $\rightarrow 4/5$ choc

<u>Cheese</u> :	<u>choc</u>	<u>Diff</u>
-----------------	-------------	-------------

6	:	5		1u
---	---	---	--	----

$1u \rightarrow 50$

$6u + 5u = 11u$

$11u \rightarrow 50 \times 11 = 550$

Mrs Tan baked a total of 550 muffins.

8) $46 - (4 \times 4) = 46 - 16 = 30$

$30 \div 3 = 10$

Diameter of semi-c $\rightarrow 10 + 4 + 4 = 18$

Radius of semi-c $\rightarrow 18 \div 2 = 9$

Circumf. Of 3 semi-c $\rightarrow 1\frac{1}{2}c \rightarrow 1\frac{1}{2} \times 2\pi r$

$= 3/2 \times 2 \times \pi \times 9 = 27\pi$

$10 + 4 = 14$

$27\pi + 14 + 10 + 14 = 27\pi + 38$

The perimeter is $(27\pi + 38)$ cm.

9)a) Tuesday and Friday

b) Thursday

c) 174

10) $\angle ADB = 90^\circ \div 2 = 45^\circ$

$\angle AFD = 180^\circ - 103^\circ = 77^\circ$ (< on a str line)

$\angle FAD = 180^\circ - 77^\circ - 45^\circ = 180^\circ - 122^\circ = 58^\circ$ (< in a Δ)

$\angle AED = \angle FAD = 180^\circ - (58^\circ \times 2) - 45^\circ$

$= 180^\circ - 116^\circ - 45^\circ = 180^\circ - 161^\circ = 19^\circ$

$\angle FDE$ is 19°

11) $\frac{-1s}{S:C}$ $\frac{-1c}{S:C}$

$2u:3u$ $7p:10p$

$2u + 1 \rightarrow 7p$

$3u \rightarrow 10p + 1$ $\times 10$

$3u - 1 \rightarrow 10p$

$20u + 10 \rightarrow 70p$ $\times 7$

$21u - 7 \rightarrow 70p$

$20u + 10 \rightarrow 21u - 7$

$10 + 7 \rightarrow 21u - 20u$

$1u \rightarrow 17$

$3u \rightarrow 51$ ©

$2u \rightarrow 34$

$34 = 1 = 35$ (s)

S : C

35 : 51

$$\begin{aligned}
 12) & 4u - 170 \rightarrow 1p \\
 & 5u - 1.25u \rightarrow 2p \\
 & \quad 3.75u \rightarrow 2p \\
 & 8u - 340 \rightarrow 2p \\
 & 8u - 340 \rightarrow 3.75u \\
 & 4.25u \rightarrow 340 \\
 & 1u \rightarrow 80 \\
 & 1p \rightarrow (4 \times 80) - 170 = 150 \\
 & 3p \rightarrow 450 \text{ fruits} \\
 & \text{Mr Tan had 450 fruits in the end.}
 \end{aligned}$$

$$\begin{aligned}
 13) a) & 3123 + 528 + 351 + 190 = 4192 \\
 & 4192 \div 4 = 1048 \\
 & 1048 \text{ Blackforest flavour cupcakes were baked.}
 \end{aligned}$$

$$\begin{aligned}
 b) & V \rightarrow 1048 - 528 = 520 \\
 & S \rightarrow 1048 - 351 = 697 \\
 & 520 + 697 = 1217 \\
 & 1217 \div 20 = 60R17 \\
 & 60 + 1 = 61
 \end{aligned}$$

A minimum of 61 boxes are needed to pack all the Strawberry-flavour and Vanilla-flavour cupcakes.

$$\begin{aligned}
 14) & \frac{1}{4}E \rightarrow \frac{1}{10}A + 625 \\
 & \frac{4}{4}E + \frac{10}{10}A \rightarrow 15100 \\
 & \frac{4}{4}E \rightarrow \frac{4}{10}A + 2500 \\
 & \frac{4}{10}A + 2500 + \frac{10}{10}A \rightarrow 15100 \\
 & \frac{14}{10}A \rightarrow 15100 - 2500 = 12600 \\
 & \frac{1}{10}A \rightarrow 12600 \div 4 = 900 \\
 & \frac{1}{4}E \rightarrow 900 + 625 = 1525 \\
 & \frac{4}{4}E \rightarrow 1525 \times 4 = 6100 \\
 & \frac{6100}{15100} \times 100\% \approx 40.4\%
 \end{aligned}$$

Elijah's share is 40.4% of the sum of money.

$$\begin{aligned}
 15) a) & 1.2L \times 10 = 12L \\
 & 12L = 12000\text{cm}^3 \\
 & 12000\text{cm}^3 \div 40\text{cm} \div 20\text{cm} = 15 \\
 & \text{The height of the water level is 15cm.}
 \end{aligned}$$

$$\begin{aligned}
 b) & 1.2L = 1200\text{cm}^3 \\
 & 1200\text{cm}^3 \div 40\text{cm} \div 20\text{cm} = 1.5\text{cm} (\text{increase in water level per min}) \\
 & 5L = 5000\text{cm}^3 \\
 & 5000\text{cm}^3 \div 50\text{cm} \div 40\text{cm} = 2.5\text{cm} \\
 & 2.5 - 1.5 = 1 \rightarrow \text{water level diff. in 1 min} \\
 & 15 \div 1 = 15 \rightarrow \text{time taken to catch up} \\
 & 8.10 \text{ am} \rightarrow 8.25 \text{ am} \\
 & \quad 15\text{min}
 \end{aligned}$$

The height of the water level in both tanks will be equal at 8.25am

16) Before

A → 100%

M → 160%

U → 104%

Given

M:A

3:1

$$1\frac{1}{2} \times 104\% = \frac{3}{2} \times 104\% = 156\%$$

$$156\% - 104\% = 52\%$$

$$4u \rightarrow 52\%$$

$$1u \rightarrow 52\% \div 3 = 13\% \text{ (A gave)}$$

$$3u \rightarrow 13\% \times 3 = 39\% \text{ (M gave)}$$

$$100\% - 13\% = 87\%$$

$$160\% - 39\% = 121\%$$

$$121\% - 87\% = 34\%$$

$$34\% \rightarrow 238$$

$$1\% \rightarrow 7$$

$$39\% \rightarrow 273$$

Michelle gave 273 cards to Usha.

$$17) a) \frac{4}{3} \times 2\pi r = \frac{4}{3} \times 2 \times \pi \times 10 \approx 83.78 \text{ cm}$$

$$b) \frac{2}{3} \times \pi r^2 = \frac{2}{3} \times \pi \times 10 \times 10 \approx 209.44 \text{ cm}$$

$$18) 5 \times 150 = 750$$

$$750 + 100 = 850$$

$$850 \div 5 = 170 \text{ (A's speed)}$$

$$170 \times 10 = 1700$$

$$1700 - (300 + 100) = 1700 - 400 = 1300$$

$$1300 \div 10 = 130 \text{ (CH's speed)}$$

$$150 - 130 = 20$$

$$300 \div 20 = 15$$

$$9 \text{ am} \rightarrow 9.15 \text{ am}$$

15min

Bernard overtook Chi Hao at 9.15am