



RED SWASTIKA SCHOOL

2016 PRELIMINARY EXAMINATION

MATHEMATICS PAPER 1

Name : _____ ()

Class : Primary 6 / _____

Date : 25 August 2016

BOOKLET A

15 Questions

20 Marks

Duration of Paper 1 (Booklets A & B): 50 minutes

Note:

1. Do not open this Booklet until you are told to do so.
2. Read carefully the instructions given at the beginning of each part of the Booklet.
3. Do not waste time. If a question is difficult for you, go on to the next one.
4. Check your answers thoroughly and make sure you attempt every question.
5. In this booklet, you should have the following:
 - (a) Page 1 to Page 6
 - (b) Questions 1 to 15
6. You are not allowed to use a calculator.

Questions 1 to 10 carry 1 mark each. Questions 11 to 15 carry 2 marks each. For each question, four options are given. One of them is the correct answer. Make your choice (1, 2, 3 or 4). Shade the correct oval (1, 2, 3 or 4) on the Optical Answer Sheet. (20 marks)

1 In 6 859 703, which digit is in the ten thousands place?

- (1) 5
- (2) 6
- (3) 8
- (4) 9

2 What is the missing number in the box?

$$0.37 \div 10 = 37 \div \square$$

- (1) 0.001
- (2) 0.01
- (3) 100
- (4) 1 000

3 A meat seller bought meat at \$2.50 per kg. He sold it at \$1.60 per 500 g. How much did he earn for selling 1 kg of meat?

- (1) \$0.35
- (2) \$0.45
- (3) \$0.70
- (4) \$0.90

4 Mindy, Nancy and Osman shared 350 stickers in the ratio 3 : 2 : 5. Find the number of stickers Osman had more than Mindy.

- (1) 35
- (2) 70
- (3) 105
- (4) 175

- 5 What is the volume of water in the beaker?

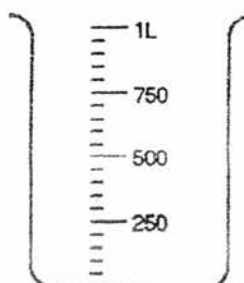

- (1) 270 ml
(2) 275 ml
(3) 300 ml
(4) 350 ml
- 6 Ganesh took 215 minutes to complete his work. What time did he start doing his work given that he completed it at 1.05 p.m.?
- (1) 9.30 a.m.
(2) 10.50 a.m.
(3) 3.20 p.m.
(4) 4.40 p.m.
- 7 The figure below is made of an equilateral triangle with sides 4 cm and a rhombus. Find the perimeter of the figure.

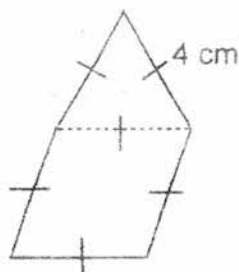

- (1) 16 cm
(2) 20 cm
(3) 24 cm
(4) 28 cm

- 8 The picture below shows a map of ABC Neighbourhood. In which direction is the cinema from Kelly's house?

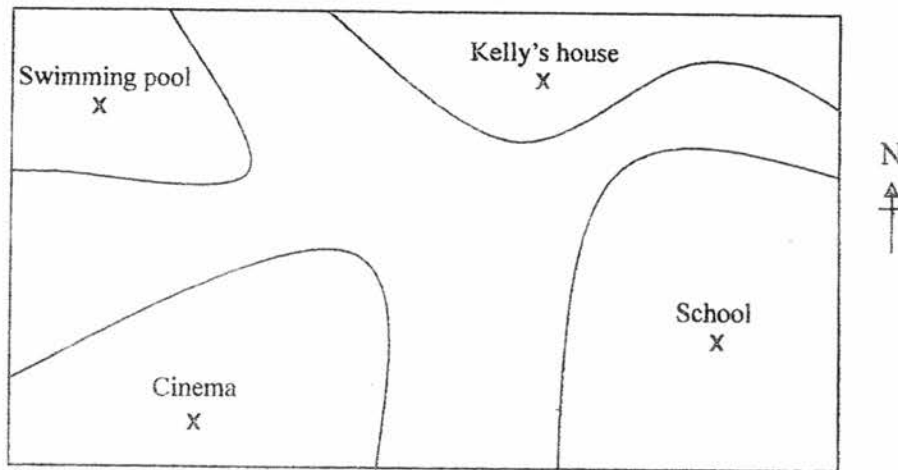

- (1) North-East
- (2) North-West
- (3) South-East
- (4) South-West

- 9 What is the sum of $\angle a$, $\angle b$, $\angle c$ and $\angle d$?

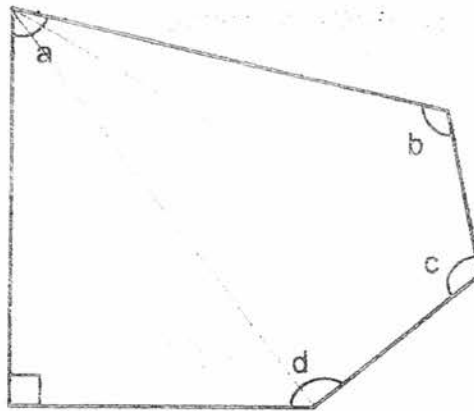

- (1) 360°
- (2) 450°
- (3) 540°
- (4) 630°

- 10 A group of 15 students was asked to choose their favourite number from 1 to 5. The table below shows the results.

Favourite Number	Number of students
1	3
2	5
3	2
4	2
5	3

How many students had chosen an odd number as their favourite number?

- (1) 6
(2) 7
(3) 8
(4) 9
- 11 For every $\frac{1}{4}$ of the pizza that Rosaline eats, Yin Le will eat $\frac{1}{6}$ of it.
What fraction of the pizza will Yin Le eat if Rosaline eats $\frac{1}{3}$ of it?

- (1) $\frac{1}{8}$
(2) $\frac{2}{9}$
(3) $\frac{1}{2}$
(4) $\frac{2}{3}$

- 12 A cardboard 9 m by 3 m was cut into 3 identical pieces. What could be the maximum perimeter of one of the cut pieces?

- (1) 8 m
(2) 12 m
(3) 20 m
(4) 24 m

- 13 The net below is folded into a cube.

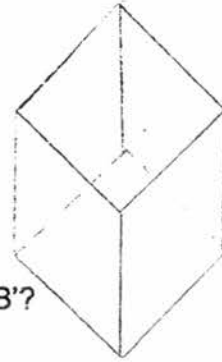
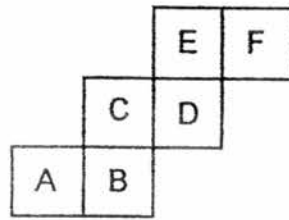

Which letter is directly opposite to the face of 'B'?

- (1) A
 - (2) C
 - (3) E
 - (4) F
- 14 The pie chart below shows the number of cars, motorcycles and lorries parked in a car park.

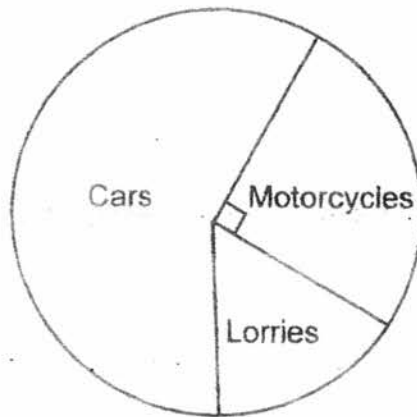

There are 10 motorcycles parked in the car park. Each motorcycle has 2 wheels while the car and lorry has 4 wheels each. Find the total number of wheels for the vehicles parked in the car park.

- (1) 40
- (2) 80
- (3) 100
- (4) 140

15 Mr Lim drove his car for 30 minutes at an average speed of 90 km/h.
Find the distance travelled by Mr Lim.

- (1) 3 km
- (2) 45 km
- (3) 180 km
- (4) 2700 km



RED SWASTIKA SCHOOL

2016 PRELIMINARY EXAMINATION

MATHEMATICS PAPER 1

Name : _____ ()

Class : Primary 6 / _____

Date : 25 August 2016

BOOKLET B

15 Questions
20 Marks

In this booklet, you should have the following:

- (a) Page 7 to Page 13
- (b) Questions 16 to 30

MARKS

	OBTAINED	POSSIBLE
BOOKLET A		20
BOOKLET B		20
TOTAL		40

Parent's Signature : _____

Questions 16 to 25 carry 1 mark each. Write your answers in the spaces provided. For questions which require units, give your answers in the units stated. (10 marks)

16 What is 2.65 when rounded off to the nearest tenth?

Ans: _____

17 The tank below contains water to a height of 4 m. Find the volume of the water in the tank.

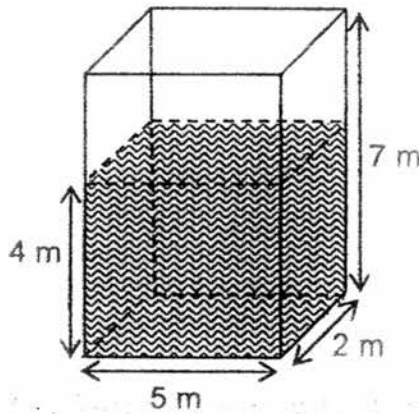

Ans: _____ m³

18 Find the area of the triangle below.

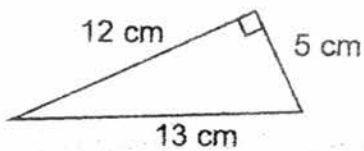

Ans: _____ cm²

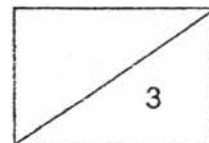

PQ and QR are two sides of a parallelogram PQRS. Use the diagram below to answer Questions 19 and 20.

- 19 Complete the parallelogram by drawing the other two sides in the square grid below.

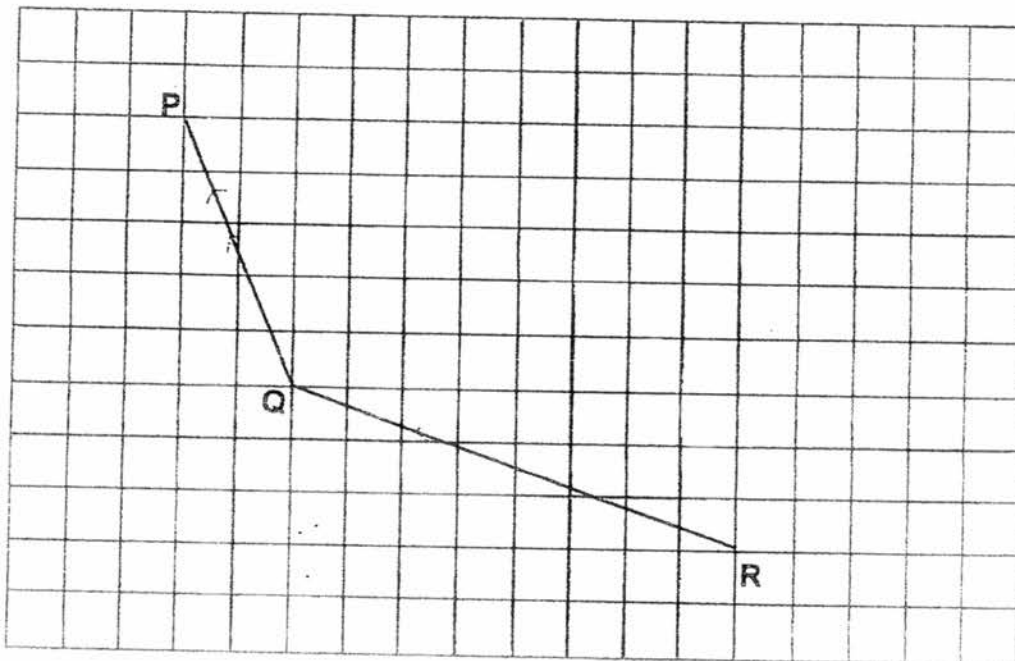

- 20 Measure and write down the size of $\angle PQR$.

Ans: _____^o

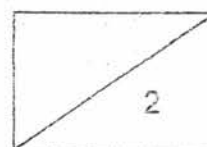

The bar graph below shows the number of families with and without children in an estate. Use the information to answer Questions 21, 22 and 23.

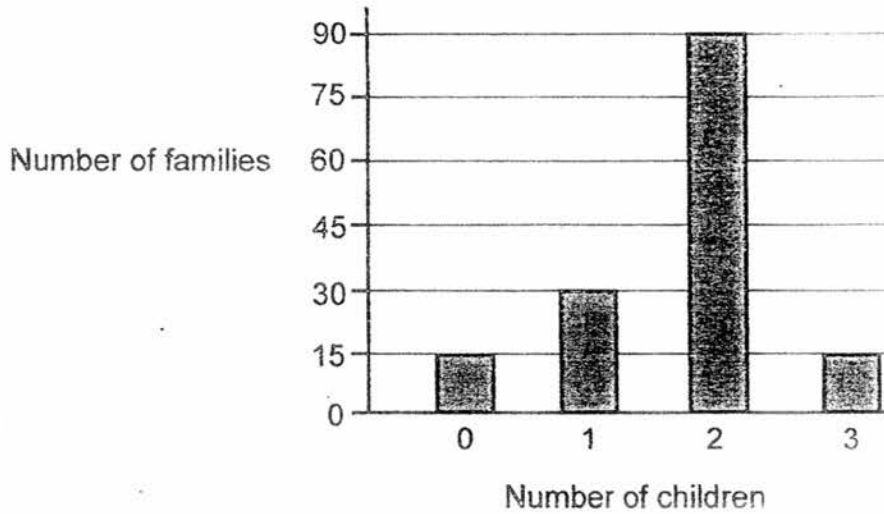

21 How many families are there in the estate?

Ans: _____

22 Find the number of children in the estate.

Ans: _____

23 Will the average number of children per family increase, decrease or remain the same when another family without children shift into the estate?

Ans: _____

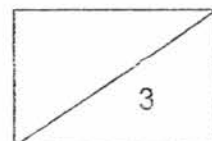

- 24 Town X and Town Y were 48 km apart. A car left Town X while a lorry left Town Y at the same time and the ratio of their average speed was 7 : 5 respectively. Find the distance travelled by the car when the two vehicles met.

Ans: _____ km

- 25 Kester and Yu Rei start cycling at the same time from the same place. If they cycle in the opposite direction, they will be 57 km apart after 2 hours. If they cycle in the same direction, Kester will be 3 km ahead of Yu Rei after 2 hours. Find Kester's average speed.

Ans: _____ km/h

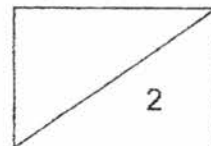

Questions 26 to 30 carry 2 marks each. Show your workings clearly in the space provided for each question and write your answers in the spaces provided. For questions which require units, give your answers in the units stated. (10 marks)

26 How many sixths are there in $12\frac{1}{2}$?

Ans: _____

27 Mrs Lim packed $\frac{2}{5}$ kg of flour equally into 6 packets. How many kilograms of flour was there in 1 packet?

Ans: _____ kg

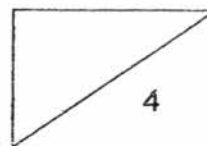

- 28 Draw two straight lines to form a symmetric figure with AB as the line of symmetry.

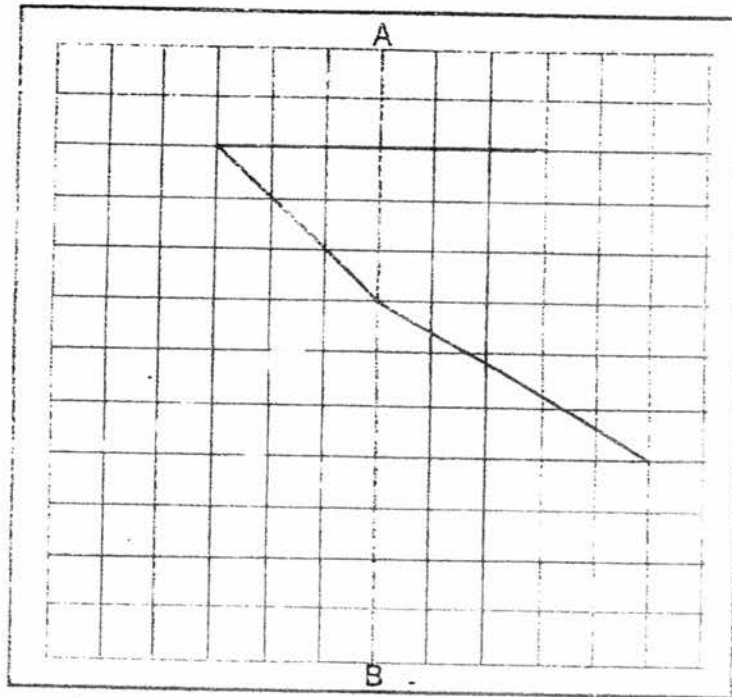

- 29 The pattern in the box below shows part of a tessellation. Extend the tessellation by drawing two more unit shapes in the space provided within the box.

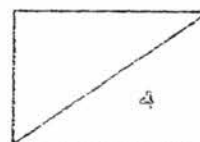
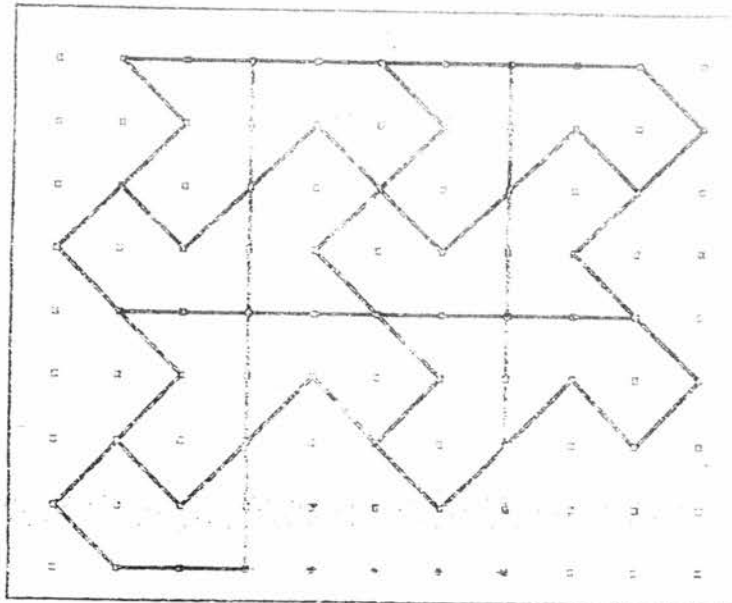

- 30 In the figure, what fraction of the square is covered by the circle? Give your answer in terms of π .

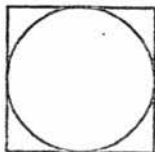

Ans: _____

END OF PAPER

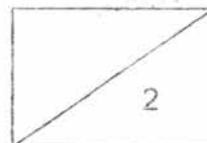



RED SWASTIKA SCHOOL
2016 PRELIMINARY EXAMINATION
MATHEMATICS
PAPER 2

Name : _____ ()

Class : Primary 6 / _____

Date : 25 August 2016

18 Questions

60 Marks

Duration of Paper 2: 1 hour 40 minutes

Note:

1. Do not open this Booklet until you are told to do so.
2. Read carefully the instructions given at the beginning of each part of the Booklet.
3. Do not waste time. If a question is difficult for you, go on to the next one.
4. Check your answers thoroughly and make sure you attempt every question.
5. In this paper, you should have the following:
 - (a) Page 1 to Page 15
 - (b) Questions 1 to 18
6. You are allowed to use a calculator.

MARKS

	OBTAINED	POSSIBLE
PAPER 1		40
PAPER 2		60
TOTAL		100

Questions 1 to 5 carry 2 marks each. Show your working clearly in the space below each question and write your answers in the spaces provided. For questions which require units, give your answers in the units stated.

(10 marks)

-
- 1 Zhi Kai had a total of 345 local and foreign stamps. He gave half of his local stamps away and bought 15 more foreign stamps. In the end, the number of the foreign stamps he had was thrice as many as the number of local stamps. How many local stamps did he have at first?

Ans: _____

-
- 2 Joyce wanted to buy 7 identical blouses but found that she was short of \$14.50. In the end, she bought 5 of the blouses and had \$8.50 left. Find the cost of each blouse.

Ans: \$ _____

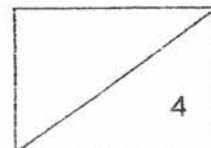

- 3 When Tina increases her number of marbles by half and Sam decreases his number of marbles by half, both of them will have y marbles each. Find their total number of marbles at first in terms of y .

Ans: _____

- 4 In the figure below, ABCD is a rhombus and DEFB is a square. BD is the diagonal of the rhombus and $\angle CBF = 235^\circ$. Find $\angle DCB$.

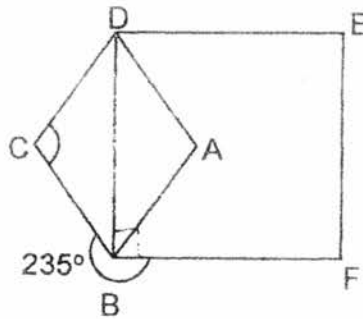

Ans: _____^o

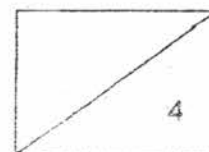

- 5 Samantha divided the triangle below into 6 smaller triangles with equal area as shown.

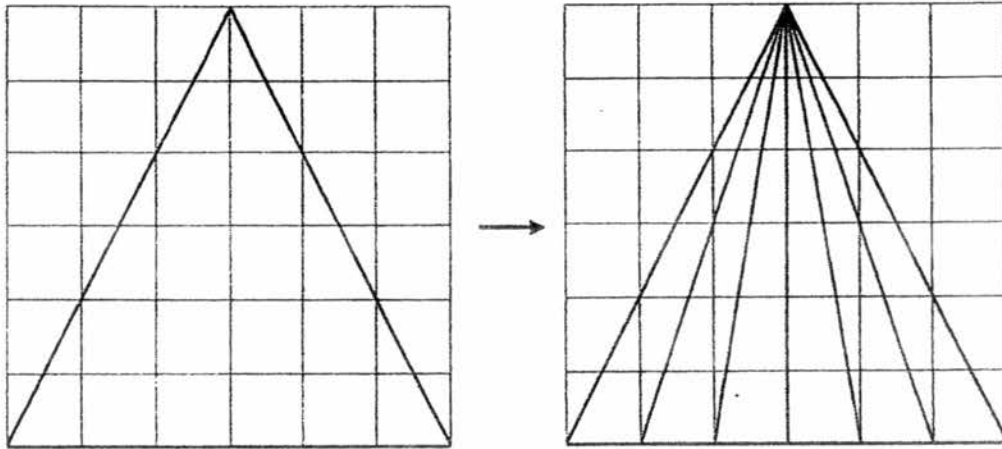

Complete the drawing below to show how Samantha can divide the triangle below into 6 smaller triangles with equal area in another way.

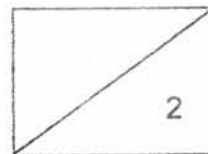
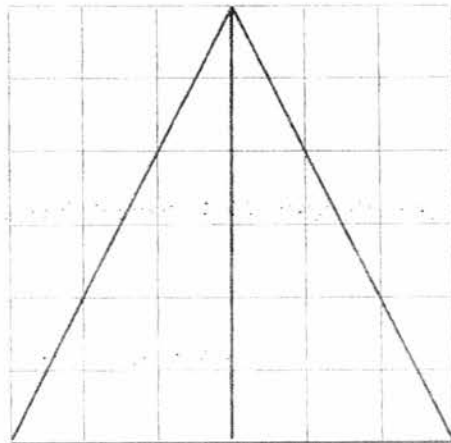

For Questions 6 to 18, show your working clearly in the space below each question and write your answers in the spaces provided. The number of marks available is shown in brackets [] at the end of each question or part-question. (50 marks)

6 Mrs Koh wants to pack 28 erasers and 70 pencils into some bags. Each bag must contain a mixture of erasers and pencils.

- (a) What is the maximum number of bags in which she can pack these items equally without any leftover?
- (b) Find the total number of items in each bag given that she packs all the items into the maximum number of bags.

Ans: (a) _____ [2]

(b) _____ [1]

7 Elise, Fahim and Greg shared a box of sweets. Elise took $\frac{2}{3}$ of the sweets from the box. Fahim took half of the remaining sweets and another 14 sweets from the box. Greg took the last 9 sweets. How many sweets were there in the box at first?

Ans: _____ [3]

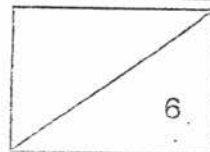

- 8 Mrs Tan has a bag containing some ten-cent and fifty-cent coins. If she adds in 4 ten-cent coins, 70% of the coins in the bag are fifty-cent coins. If she continues to add in another 20 fifty-cent coins, 80% of the coins in the bag are fifty-cent coins. Find the value of her ten-cent coins at first.

Ans: _____ [3]

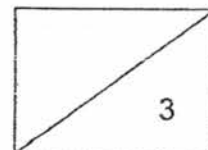

- 9 The diagrams below show a balloon placed beside two vertical poles. At first, the ratio of the height of each pole above the balloon is 4 : 1, as shown in Diagram 1. When the balloon is lowered by 30 cm as shown in Diagram 2, the ratio of the height of each pole above the balloon became 11 : 5. Find the difference in the height of both poles.

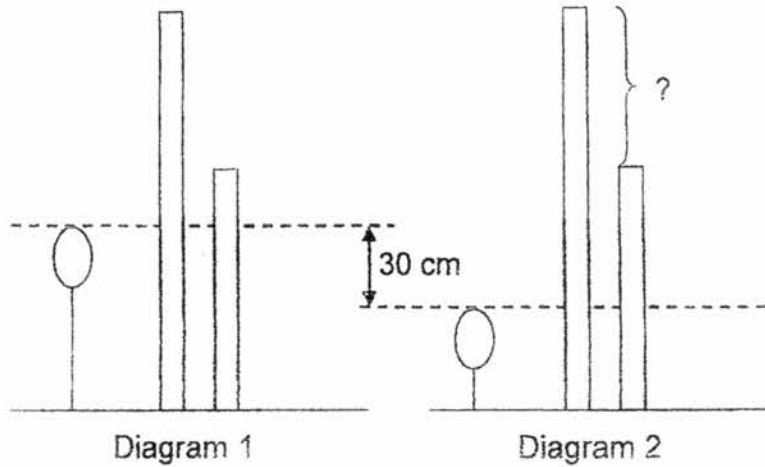

Ans: _____ [3]

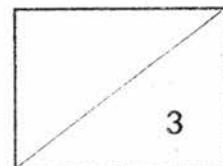

- 10 In the figure below, the diameter of the two identical quadrants is 40 cm. Find the perimeter of the figure. Take $\pi = 3.14$.

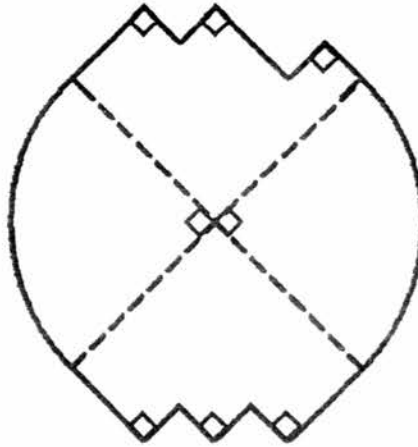

Ans: _____ [3]

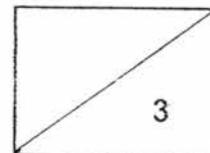

- 11 In the figure below, AD, BE and CF are the diameters of the circle. Given that $OA = FE$,

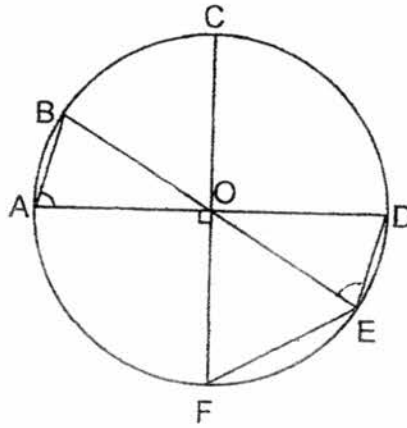

- (a) name an isosceles triangle in the figure,
 (b) find $\angle OAB$.

Ans: (a) _____ [1]

(b) _____ [2]

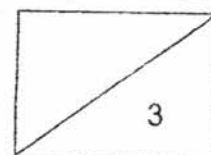

- 12 Bala stacked some cubes into a solid as shown below. The base area of each cube is 16 cm^2 . The volume of the solid is 896 cm^3 .

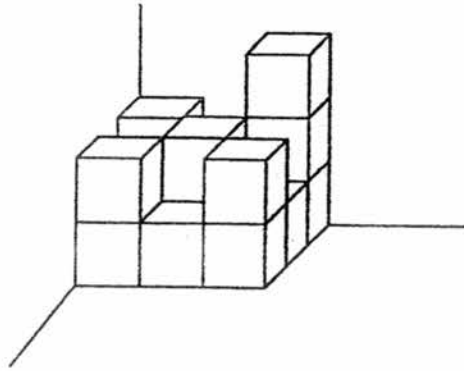

- (a) Find the volume of one cube.
- (b) How many cubes did Bala use?
- (c) Bala observed his solid from the top. Which one of the following (P, Q, R or S) shows the top view of his solid?

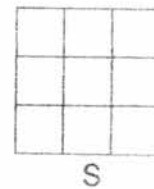
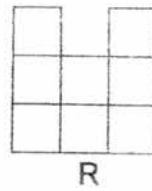
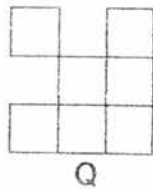
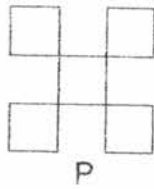

Ans: (a) _____ [2]

(b) _____ [1]

(c) _____ [1]

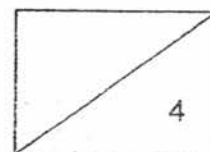

- 13 Figure 1 shows a square tile. Each inner square is formed by joining the mid-points of the sides of the outer square.

Figure 1

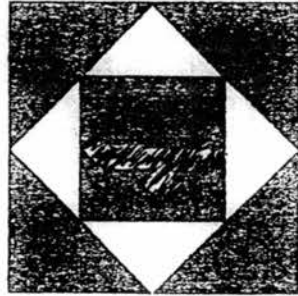

- (a) What fraction of the square tile in Figure 1 is shaded?
- (b) Figure 2 shows a bigger square ABCD, 100 cm by 100 cm, laid with the square tiles. Find the total shaded area in the bigger square ABCD.

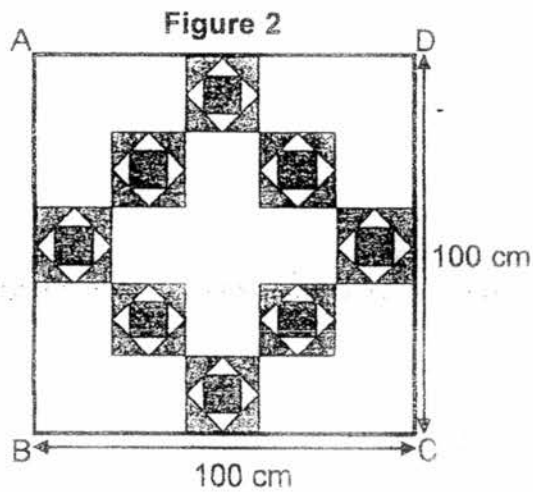

Ans: (a) _____ [1]

(b) _____ [3]

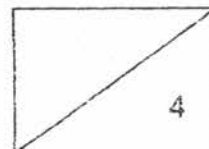

14 Sean, Ken and Don sat for a Mathematics test. All their marks scored were in whole numbers. The sum of Sean's and Ken's marks was 156. The average marks of the three boys were 75.

- (a) Find Don's mark.
- (b) Given that Don scored the lowest mark and Sean scored the highest mark among the three boys, what could be the highest possible marks Sean had scored?

Ans: (a) _____ [2]

(b) _____ [2]

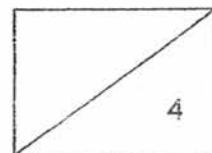

15 A trapezium-shaped table can seat 5 people.

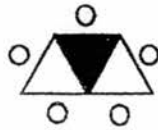

Mr Png uses the trapezium-shaped tables to form figures that follow a pattern to plan the number of people sitting around the tables for a gathering. The first three figures are shown below.

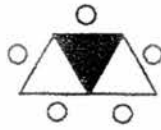

Figure 1

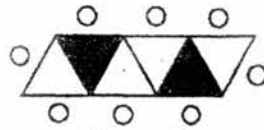

Figure 2

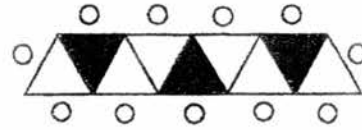

Figure 3

- (a) The table below shows the number of people Mr Png could plan for each figure. Complete the table for Figure 4.

Figure Number	Total number of people	Number of people who are seated at the unshaded triangles
1	5	4
2	8	6
3	11	8
4		10

[1]

- (b) Find the least number of trapezium-shaped tables Mr Png need if he is planning to seat 21 people around the tables.
- (c) Find the maximum number of people who could sit around the trapezium-shaped tables if Mr Png plans 24 people to sit at the unshaded triangles of his tables.

Ans:(b) _____ [2]

(c) _____ [2]

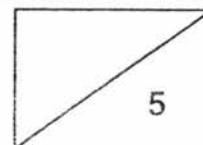

- 16 Pauline places 2 identical three-quarter circles onto a black rectangular mat without overlapping as shown in the diagram below. The diameter of each of the three-quarter circle is 28 cm.

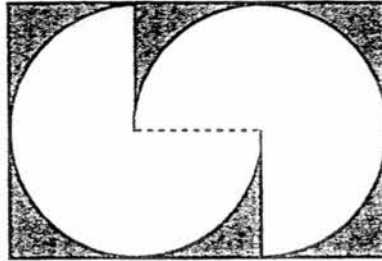

- (a) Find the length of the rectangular mat.
- (b) Find the area of the rectangular mat not covered by the 2 identical three-quarter circles.

Take $\pi = \frac{22}{7}$.

Ans: (a) _____ [1]

(b) _____ [4]

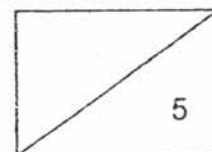

17 4 children, Abby, Ben, Chris and Denise, shared some story books. Abby received 20% less story books than Ben while the remaining story books were shared between Chris and Denise in the ratio of 7 : 5. Given that Denise received 25% of the number of story books Abby received,

- (a) what fraction of the total story books did Chris received?
- (b) what percentage of Abby's story books must be given to Denise so that they both have the same number of story books?

Ans: (a) _____ [3]

(b) _____ [2]

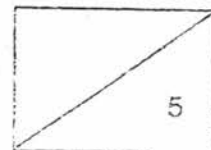

18. Mr Wang sold 4 times as many ipads as laptops and collected a total of \$8 400. Each laptop costs \$325 more than an ipad. The amount collected for all the ipads sold was \$3 480 more than the amount collected for all the laptops sold. How many laptops did Mr Wang sell?

Ans: _____ [5]

END OF PAPER 2

5

PRELIMINARY EXAM PAPER 2016

SCHOOL : RED SWASTIKA PRIMARY SCHOOL
SUBJECT : MATHEMATICS
TERM : PRELIMINARY EXAMINATION 2016

PAPER 1

BOOKLET A

Q1	Q2	Q3	Q4	Q5	Q6	Q7	Q8	Q9	Q10
1	4	3	2	4	1	2	4	2	3
Q11	Q12	Q13	Q14	Q15					
2	3	3	4	2					

BOOKLET B

16) 2.7 17) $40m^3$ 18) $30cm^2$

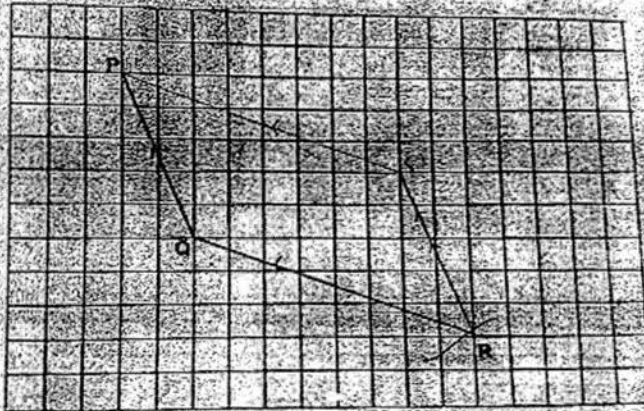

19)

20) 133° 21) 150 22) 255 23) Decrease 24) 28km 25) 15km/h

26) 75 27) $\frac{1}{15}$ kg

28)

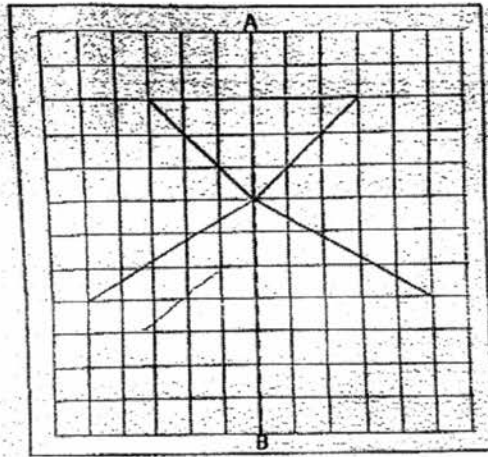

29)

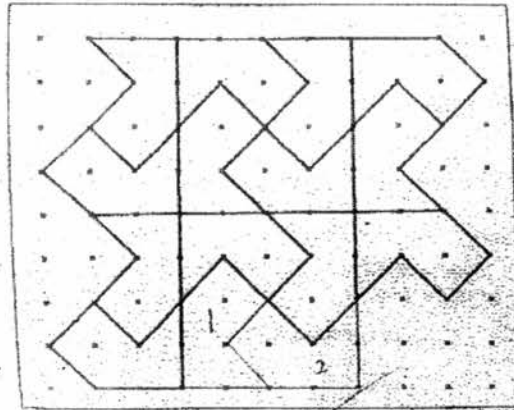

30) $\frac{\pi}{4}$

PRELIMINARY EXAM PAPER 2016

SCHOOL : RED SWASTIKA PRIMARY SCHOOL
SUBJECT : MATHEMATICS PRIMARY 6
TERM : PRELIMINARY EXAMINATION 2016

PAPER 2

Q1 WORKING

$$L: F = 1:3$$

$$5 \text{---} 345 + 15 = 360$$

$$1u = 72$$

$$2u = 144$$

Answer: 144

Q2 WORKING

$$2 \text{ blouses --- } \$14.50 + \$8.50 = 23$$

$$1 \text{ blouse --- } \$11.50$$

Answer: \$11.50

Q3 WORKING

$$3u \text{---} y$$

$$1u \text{---} \frac{y}{3}$$

$$8u \text{---} \frac{8y}{3}$$

Answer: $\frac{8y}{3}$

Q4 WORKING

$$360 - 325 - 92 = 35$$

$$180 - 35 - 35 = 110$$

Answer: 110°

Q6 WORKING

a) Factor of 28: 1,2,4,7,14,28

Factor of 70: 1,2,5,7,10,14

b) $28 \div 14 = 2$

$70 \div 14 = 5$

$2 + 5 = 7$

Answer: a) 14, b) 7

Q7 WORKING

1u ---- $9 + 14 = 23$

6u ---- 138

Answer: 138

Q8 WORKING

$10c : 50c = 3 : 7 \times 2 = 6 : 14 (+20)$

$2 : 8 \times 3 = 6 : 24$

$24 - 14 = 10$

10u --- 20

1u ---- 2

6u --- 12

$12 - 4 = 8$

$8 \times \$0.10 = \0.80

Answer: \$0.80

Q9 WORKING

$$T : S : O = 4 : 1 : 3 \text{ (x2)}$$
$$8 : 2 : 6$$

$$30 : -30$$

$$11 : 5 : 6$$

$$3u \text{ --- } 30\text{cm}$$

$$6u \text{ --- } 60\text{cm}$$

Answer : 60cm

Q10 WORKING

$$\frac{1}{2} \times \pi \times 40 = 62.80$$

$$20 \times 4 = 80$$

$$62.80 + 80 = 142.80$$

Answer : 142.8cm

Q11 WORKING

$$S / 180 - 30 = 150$$

$$150 \div 2 = 75$$

Answer: a) DOE b) 75°

Q12 WORKING

$$(a) \sqrt{16} = 4$$

$$4 \times 4 \times 4 = 64$$

$$(b) \sqrt{16} = 4$$

$$4 \times 4 \times 4 = 64$$

$$896 \div 65 = 4$$

Answer: (a) 64cm² (b) 14 (c) (R)

Q13 WORKING

$$(a) 2u \times 2u = 4u$$

$$1u \times 1u = 1u$$

$$\frac{1}{2}u \times 1u \times 1u = \frac{1}{2}u$$

$$\frac{1}{2}u \times 4 = 2u$$

$$2u + 1u = 3u$$

$$(b) 100 \div 5 = 20$$

$$20 \times 20 = 400$$

$$\frac{3}{4} \times 400 = 300$$

$$300 \times 8 = 2400$$

$$\text{Answer: (a) } \frac{3}{4}, \text{ (b) } 2400 \text{ cm}^2$$

Q14 WORKING

$$(a) 75 \times 3 = 225$$

$$225 - 156 = 69$$

$$(b) 156 \div 2 = 78$$

$$78 - 69 = 9$$

$$9 - 1 = 8$$

$$78 + 8 = 86$$

$$\text{Answer: (a) } \underline{69} \text{ (b) } \underline{86}$$

Q15 WORKING

$$(b) \text{ Fig 5 --- } 17$$

$$\text{Fig 6 --- } 20$$

$$\text{Fig 7 --- } 21$$

$$21 - 2 = 19$$

$$19 \div 3 = 6R1 \approx 7$$

$$(c) 24 - 2 + 22$$

$$22 \div 2 = 11$$

$$11 \times 3 = 33$$

$$33 + 2 = 35$$

$$\text{Answer: (a) } \underline{14}, \text{ (b) } \underline{7}, \text{ (c) } \underline{35}$$

Q16 WORKING

(a) $28 + 14 = 42$

(b) $\frac{3}{4} \times \frac{22}{7} \times 14 \times 14 = 462$

$462 \times 2 = 1176$

$1176 - 924 = 252$

Answer: (a) 42cm, (b) 252 cm²

Q17 WORKING

(a)

Abby

--	--	--	--	--	--

Ben

--	--	--	--	--	--

Denise

--

Abby : Ben = 20 : 25

Chris : Denise = 7 : 5

$20 + 25 + 7 + 5 = 57$

Chris: $\frac{7}{57}$

(b) Denise & Abby in the end = $\frac{20u+5}{2} = 12.5u$

$20u - 12.5u = 7.5u$

$\frac{7.5}{20} \times 100\% = 37.5\%$

Answer: (a) $\frac{7}{57}$ (b) 37.5%

Q18 WORKING

$$8400 - 3480 = 4920$$

$$4920 \div 2 = 2460 \text{ (laptop money collected)}$$

$$2460 + 3480 \text{ (ipad money collected)}$$

$$495 \times 12 = 5940$$

$$12 \div 4 = 3$$

Answer: 3

End of paper 2

www.testpaper.biz