

SA1

Anglo-Chinese School (Junior)**SEMESTRAL ASSESSMENT (2021)****PRIMARY 6****SCIENCE****BOOKLET A****Tuesday****18 May 2021****1 hr 45 min**

Name: _____ () Class: 6.()

INSTRUCTIONS TO PUPILS

- 1 Do not turn over the pages until you are told to do so.
- 2 Follow all instructions carefully.
- 3 There are 28 questions in this booklet.
- 4 Answer ALL questions.
- 5 Shade your answers in the Optical Answer Sheet (OAS) provided.

This question paper consists of 15 printed pages (inclusive of cover page).

2

For each question from 1 to 28, four options are given. One of them is the correct answer. Make your choice (1, 2, 3 or 4) and shade your answer on the Optical Answer Sheet.

(56 marks)

1. Max has a medical condition. He has fungus growing on his feet.



The doctor advised Max to wear slippers instead of covered shoes as -

- (1) there will be no trapped air for the fungus to grow
 - (2) water from his sweat will evaporate faster from his feet
 - (3) more water vapour will condense into water droplets on his feet
 - (4) air flowing through his feet will make the temperature too cold for the fungus to grow
2. The diagram shows a bulb.



The table shows the properties of some materials.
Which material is most suitable for making part A of the bulb?

Material	Characteristics
(1) A	<ul style="list-style-type: none"> • Soft • Allows some light to pass through • Poor conductor of electricity
(2) B	<ul style="list-style-type: none"> • Soft • Does not allow light to pass through • Poor conductor of electricity
(3) C	<ul style="list-style-type: none"> • Hard • Allows most light to pass through • Poor conductor of electricity
(4) D	<ul style="list-style-type: none"> • Hard • Allows some light to pass through • Good conductor of electricity

3

3. Study the human organ systems.

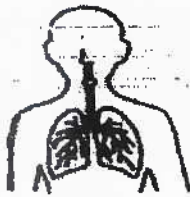

System X

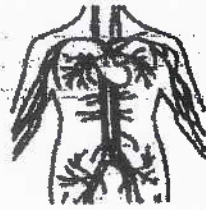

System Y

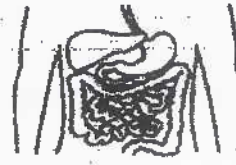

System Z

Which statements are true?

- A System X provides the body with support and shape.
- B System Y transports oxygen from system X to all parts of the body.
- C A substance is transported from system Z to all parts of the body by system Y.
- D System Y transports only water and mineral salts from system Z to all parts of the body.

- (1) A and B only
- (2) B and C only
- (3) A, C and D only
- (4) B, C and D only

4. Ian set-up an experiment as shown.

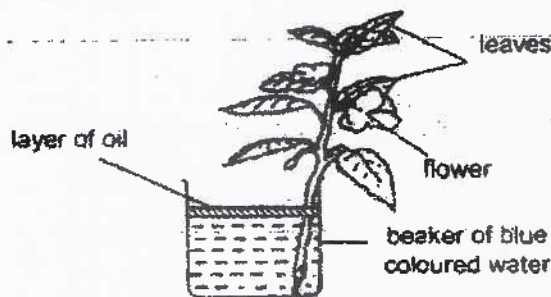

After two days, Ian observed that the leaves and flowers of the plant were stained blue. Which statement explains his observation?

- (1) Water-carrying tubes are present in the leaves and flower only.
- (2) Food made in the leaves are transported to all parts of the plant.
- (3) Food-carrying tubes transported the blue coloured water up the stem to all parts of the plant.
- (4) Water-carrying tubes transported the blue coloured water up the stem to all parts of the plant.

5. Josiah placed a mouse in a sealed tank for six hours.

Which of the following correctly shows the changes in the volume of the different gases in the tank after six hours?

	Carbon dioxide	Oxygen	Water vapour
(1)	the same	more	less
(2)	more	less	the same
(3)	less	more	the same
(4)	more	less	more

6. The diagram shows the direction of blood flow in some parts of the body.

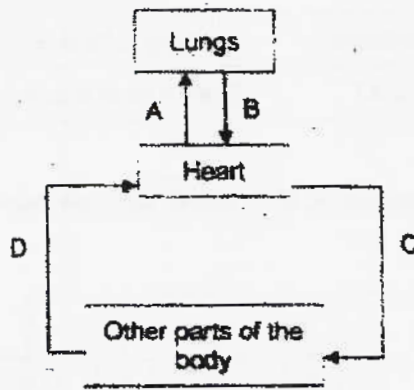

The same amount of blood was taken from A, B, C and D. Which graph shows the correct comparison of the amount of carbon dioxide in the blood samples?

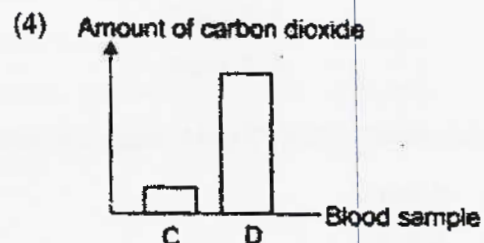
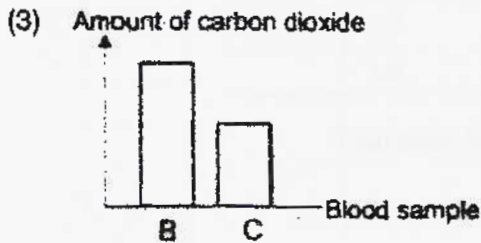
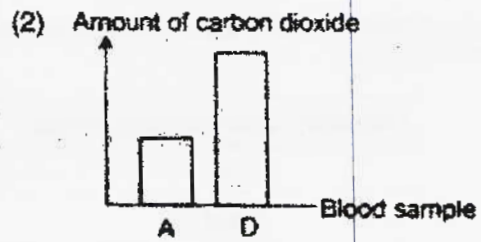
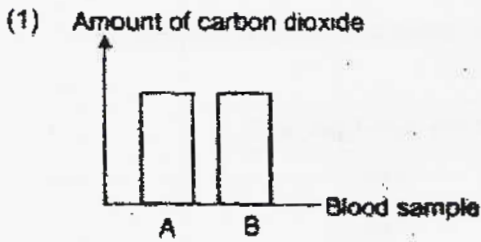

5

7. Study the flowchart.

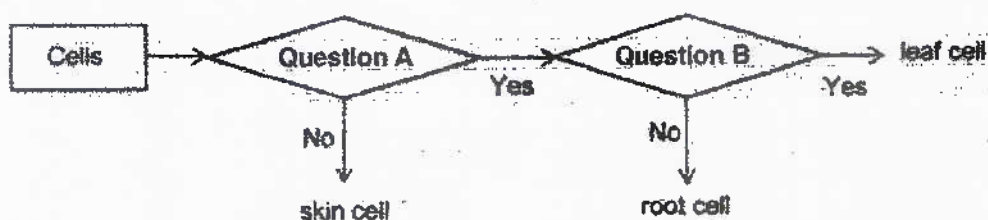

Which correctly represents questions A and B?

	Question A	Question B
(1)	Does it have chloroplast?	Does it have a cell wall?
(2)	Does it have a cell wall?	Does it have chloroplast?
(3)	Does it have a cell membrane?	Does it have a nucleus?
(4)	Does it have a nucleus?	Does it have a cell membrane?

8. Ji Heng wanted to find out if objects, A, B, C, and D, were electrical conductors. He set up the circuit shown.

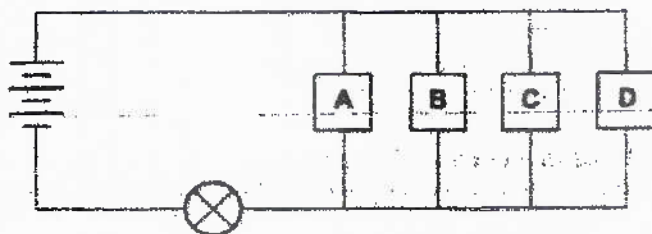

Ji Heng recorded what happened to the bulb when certain objects were removed from the circuit.

Object(s) removed from circuit	Did the bulb light up?
A	Yes
B and C	Yes
A, B and C	No
A, C and D	No

Which object(s), A, B, C and D is/are conductors of electricity?

- (1) A only
- (2) B only
- (3) A and C only
- (4) B, C and D only

9. David conducted an experiment by adding bulbs to two similar circuits as shown.

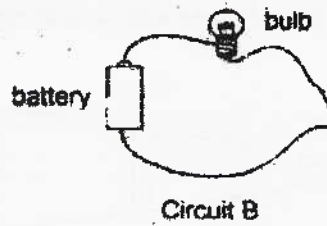
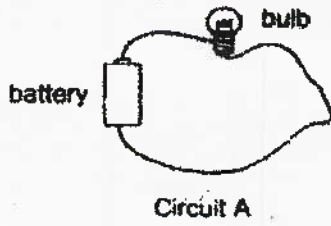

He kept adding identical bulbs to each circuit until the bulbs in circuit B did not light up anymore. He recorded his observation in the graphs as shown.

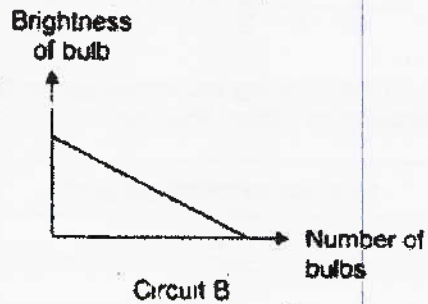
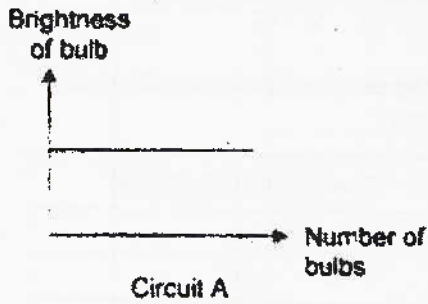

How did David arrange the bulbs in each circuit?

	Circuit A	Circuit B
(1)	Parallel	Series
(2)	Series	Parallel
(3)	Parallel	Parallel
(4)	Series	Series

7

10. Alvin placed a torchlight at the 1 cm mark and an object at the 4 cm mark of the ruler as shown. A shadow was cast on the screen.

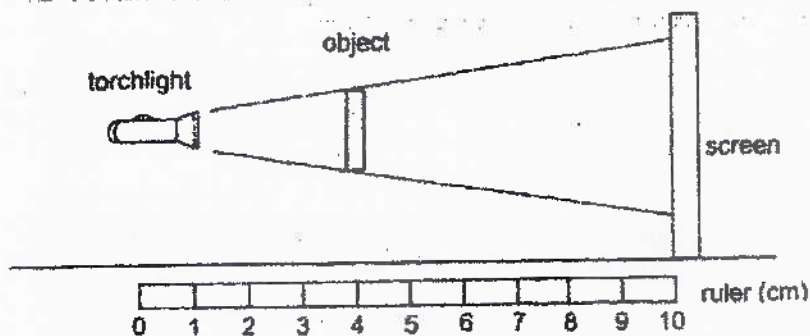

Which of the following two combinations of the positions of the torchlight and object will cast bigger shadow on the screen?

	Position of torchlight (cm)	Position of object (cm)
A	0	4
B	1	3
C	2	8
D	4	6

- (1) A and C
 (2) B and C
 (3) B and D
 (4) A and D
11. Ryan placed an empty glass flask with a rubber stopper into a hot basin of water as shown in the diagram. After a while, Ryan observed that the rubber stopper popped out of the glass flask.

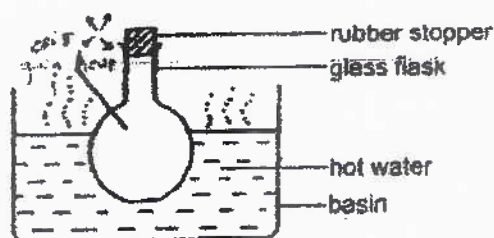

Which of the following correctly explains why the rubber stopper popped out?

- (1) The flask contracted.
 (2) The air in the flask expanded.
 (3) The hot water lost heat to the surroundings.
 (4) The rubber stopper gained heat and expanded.

8

12. Brandon wanted to test the heat conductivity of two materials. He used identical sized rods made of different materials, A and B, and set up the experiment.

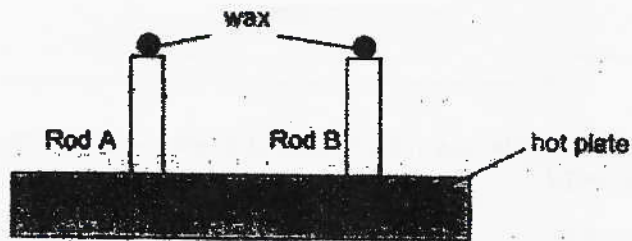

He recorded the time taken for the wax to melt completely on each rod in the table.

Rod	A	B
Time taken (min)	6	30

Which is a better material to store ice and the correct reason for it?

	Material of Rod	Reason
(1)	A	Rod A took a shorter time to melt the wax.
(2)	A	Rod A is a better conductor of heat than Rod B.
(3)	B	Rod B gains heat faster than Rod A.
(4)	B	Rod B loses heat slower than Rod A.

13. Jake set up the experiment in the garden as shown in the diagram. Leaves A, B and C are wrapped tightly in a clear plastic bag so that no air can enter or escape.

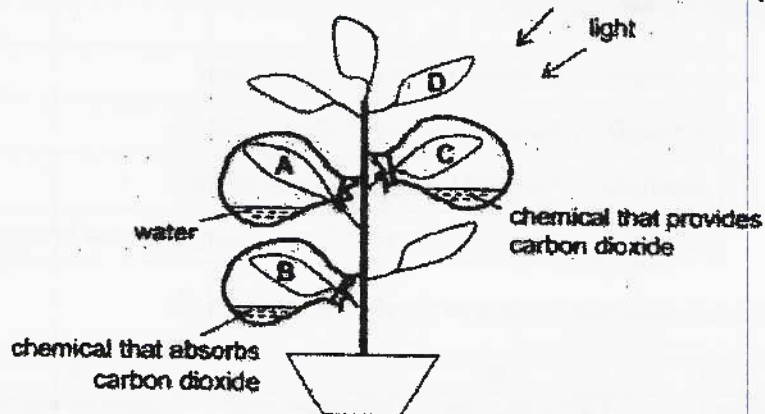

Which leaves would be able to photosynthesise?

- (1) A and C only
- (2) B and D only
- (3) A, B and C only
- (4) A, C and D only

9

14. A ball is released from point A.



Which graph shows the changes in the amount of potential energy of the ball as it rolls down the ramp?

- (1) Potential energy

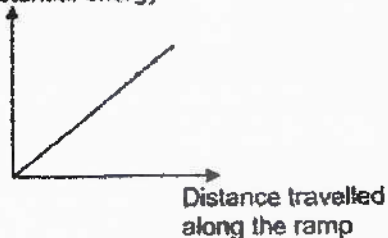

- (2) Potential energy

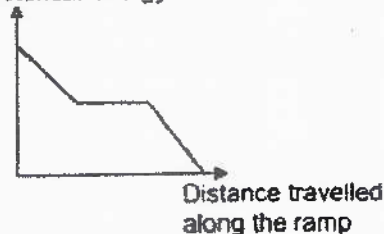

- (3) Potential energy

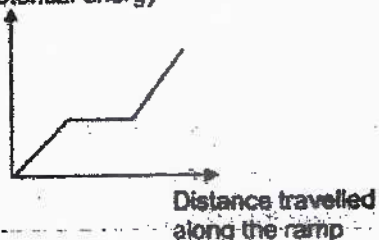

- (4) Potential energy

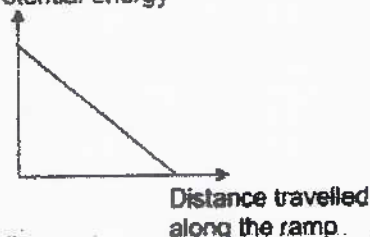

15. Kelvin conducted four activities, A, B, C and D. He recorded the main energy conversion(s) for each activity

Activity A	Electrical Energy \rightarrow Heat Energy
Activity B	Electrical Energy \rightarrow Kinetic Energy
Activity C	Potential Energy \rightarrow Kinetic Energy
Activity D	Potential Energy \rightarrow Kinetic Energy \rightarrow Heat Energy

Which of the following best represents activities A, B, C and D?

	A	B	C	D
(1)	Using an electric fan	Turning a toy pinwheel	Rubbing your hands together	Using an electric iron
(2)	Turning a toy pinwheel	Rubbing your hands together	Using an electric iron	Using an electric fan
(3)	Rubbing your hands together	Using an electric iron	Using an electric fan	Turning a toy pinwheel
(4)	Using an electric iron	Using an electric fan	Turning a toy pinwheel	Rubbing your hands together

10

16. Ali did an experiment by placing a toy car on material X and held a magnet under it as shown.

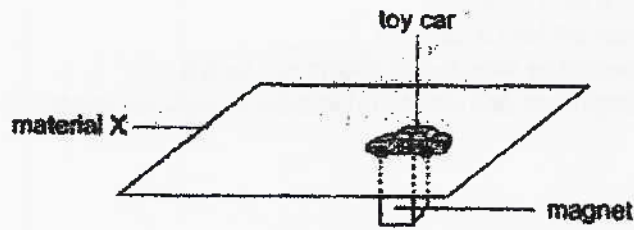

When Ali moved the magnet, the toy car moved in the same direction. What conclusions can be made based on Ali's experiment?

- A The magnet was attracted to material X.
- B The toy car is made of magnetic material.
- C Material X is made of non-magnetic material.
- D The magnetic force acting on the toy car is weak.

- (1) A and B only
- (2) B and C only
- (3) C and D only
- (4) A and D only

17. Two bar magnets, A and B, were brought close to each other as shown.

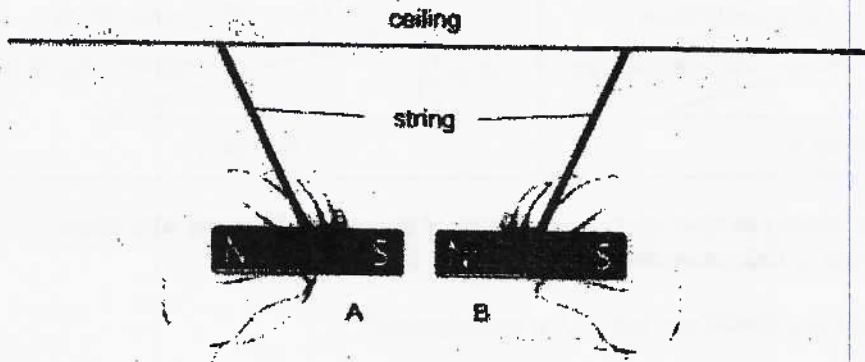

Which is the correct direction of the magnetic force acting on each magnet after the magnets were released?

	A	B
(1)	→	→
(2)	←	→
(3)	→	←
(4)	←	←

18. Which of the following statements about forces are true?

- A A force is a form of energy.
- B A force can act from a distance.
- C A force cannot be seen but its effects can be felt.
- D Gravitational force and magnetic force are always pull forces.

- (1) A and D only
- (2) B and C only
- (3) A, B and C only
- (4) B, C and D only

19. Betty conducted an experiment using metal blocks of the same size but with different masses. She released the blocks from ramps with different types of surfaces as shown.

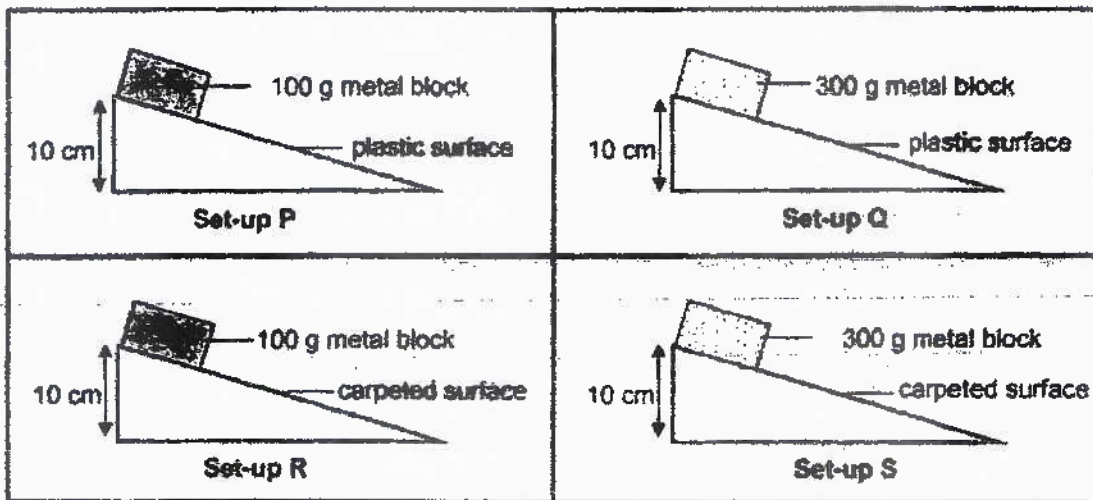

She wanted to investigate how the type of surface of the ramp affects the time taken by the metal block to slide down the ramp.

Which pair of set-ups should she use for her investigation?

- (1) P and Q
- (2) P and R
- (3) Q and R
- (4) P and S

20. Carl took a walk in the eco-garden and recorded the number of organisms he found there. He then classified them into two groups, plants and animals.

Plants	Animals
4 orchid plants	2 caterpillars
2 mango trees	3 butterflies
2 staghorn ferns	3 dragonflies
	2 water snails
	5 garden snails

How many populations of organisms did he find in the garden?

- (1) 6
- (2) 7
- (3) 8
- (4) 23

21. Study the food web.

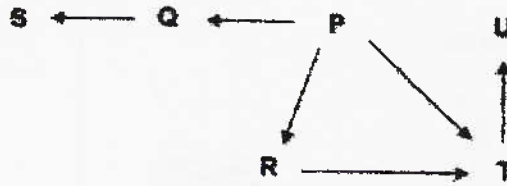

Which animals are prey and/or predator?

	Prey	Predator
(1)	P, R, T	S, T, U
(2)	Q, R, T	S, T, U
(3)	S, T, U	Q, R, T, S
(4)	Q, R, T	Q, R, S, T, U

22. The table shows the characteristics of three animals A, B and C.

Characteristics	Animals		
	A	B	C
The adult has three pairs of legs.	No	No	Yes
The young looks like the adult.	Yes	No	No
The adult lays its eggs in water.	No	Yes	Yes

Which animal(s) is/are likely to have a four-stage life cycle?

- (1) A only
- (2) C only
- (3) A and B only
- (4) B and C only

23. Which structural adaptations of the polar bear help it to cope with the extreme temperature of the environment it lives in?

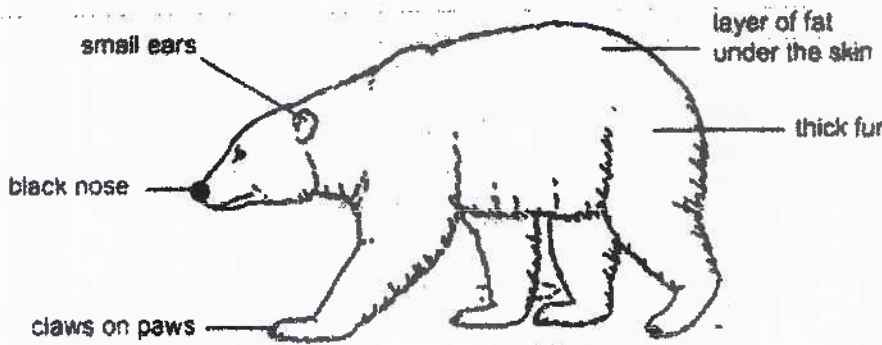

- (1) black nose and claws
- (2) thick fur and layer of fat
- (3) small ear, black nose and claws
- (4) small ears, thick fur and layer of fat

24. The diagram shows fruits from different plants.



What are the dispersal methods of the fruits?

	A	B	C
(1)	animals	wind	splitting
(2)	wind	water	animals
(3)	splitting	wind	animals
(4)	water	animals	splitting

25. Alice placed a glass of water with ice cubes on a table and observed it for five minutes. Which processes occurred during the five minutes?

- A melting
- B freezing
- C condensation



- (1) A only
- (2) A and B only
- (3) A and C only
- (4) A, B and C

26. James drew the water cycle as shown.

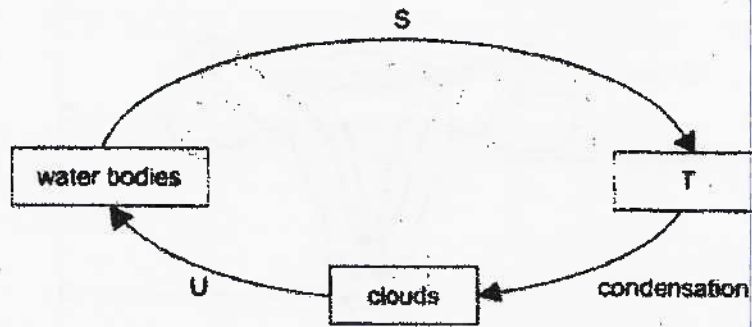

Which of the following correctly identifies S, T and U?

	S	T	U
(1)	evaporation	tiny water droplets	falls as snow
(2)	condensation	water vapour	falls as snow
(3)	evaporation	water vapour	falls as rain
(4)	boiling	tiny water droplets	falls as rain

27. Jack filled two identical beakers with water and marbles as shown. He poured all the water and the marbles into large beaker.

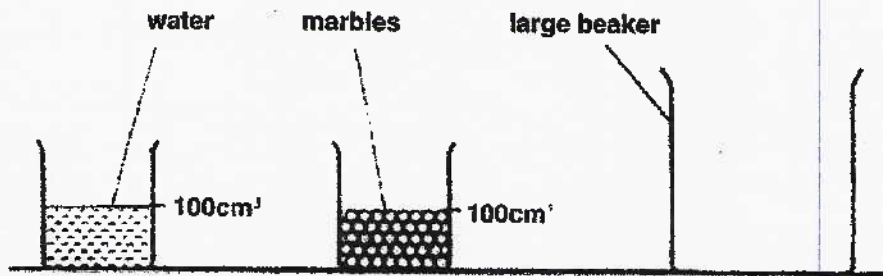

What is the total volume of the water and marbles in the large beaker and the explanation for it?

	Total Volume	Explanation
(1)	190 cm ³	The marbles displaced some of the water.
(2)	190 cm ³	The water displaced the air between the marbles.
(3)	200 cm ³	The water and the marbles are 100 cm ³ each.
(4)	200 cm ³	The water and marbles occupied space in the large beaker.

28. The diagram shows various parts of the female reproductive system.

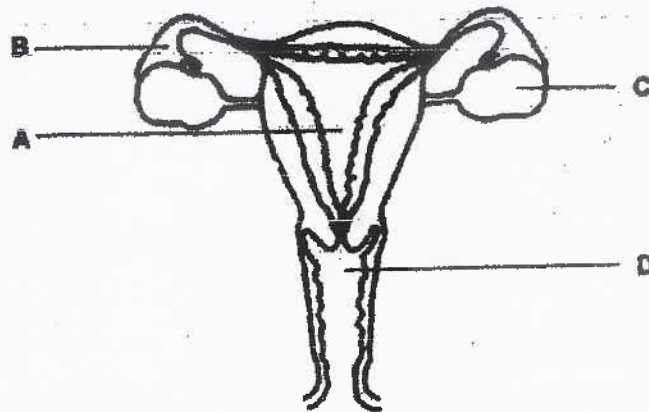

In which part of the female reproductive system will a foetus grow?

- (1) A
- (2) B
- (3) C
- (4) D

End of Booklet A

Anglo-Chinese School (Junior)



SEMESTRAL ASSESSMENT (2021)

PRIMARY 6

SCIENCE

BOOKLET B

Tuesday

18 May 2021

1 hr 45 min

Name: _____ () Class: 6 ()

INSTRUCTIONS TO PUPILS

- 1 Do not turn over the pages until you are told to do so.
- 2 Follow all instructions carefully.
- 3 There are 13 questions in this booklet.
- 4 Answer ALL questions.
- 5 The marks are given in the brackets [-] at the end of each question or part question.

Booklet	Possible Marks	Marks Obtained
A	56	
B	44	
Total	100	

This question paper consists of 18 printed pages (inclusive of cover page).

For questions 29 to 41, write your answers in this booklet.

The number of marks available is shown in brackets [] at the end of each question or part question. (100 marks)

29. Josh cut and removed two parts, X and Y, of a stem as shown.

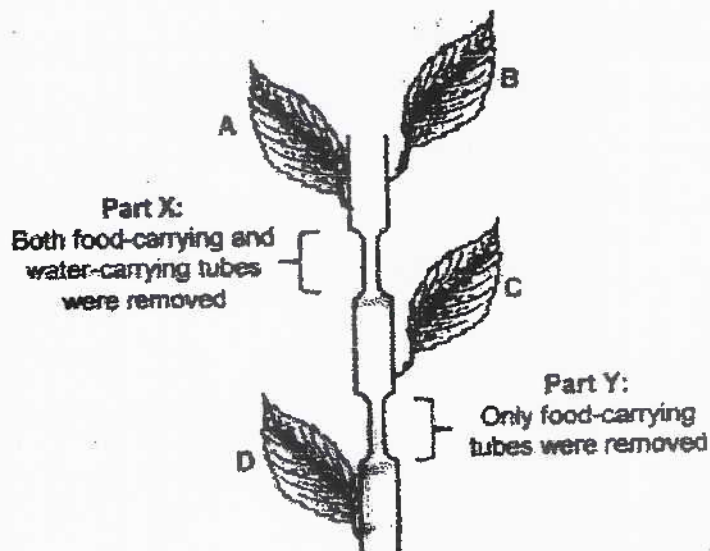

(a) Which leaves, A, B, C and/or D will die after some time? Explain your answer. [1]

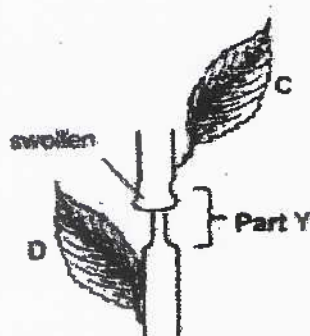

(b) After a few days, Josh observed that the stem just above part Y became swollen. Explain why. [2]

(Go on to the next page)

SCORE	3
-------	---

30. Fishes absorb dissolved oxygen from the water as the water passes through the gills.

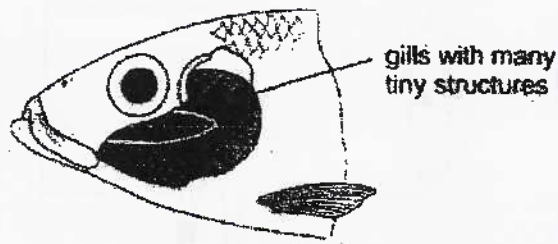

(a) Other than absorbing dissolved oxygen from the water, state another function of the gills. [1]

(b) Explain how the many tiny structures of the gills help the fish get more dissolved oxygen. [1]

(c) Mr Lim set up an experiment as shown in the diagram and placed both tanks, R and S, near the window.

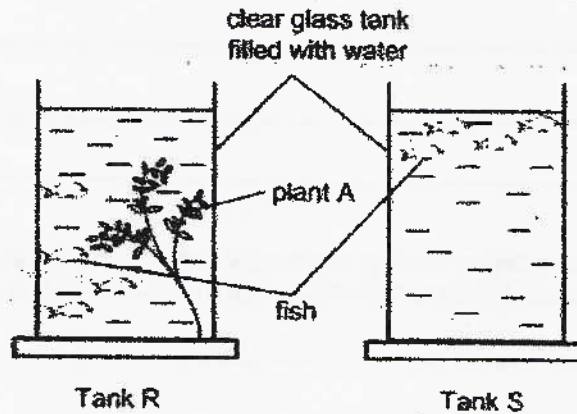

After a few hours, Mr Lim observed that the fish in tank R swam freely while the fish in tank S swam near the water surface.

Mr Lim concluded that the presence of plant A helped the fish survive better. Explain why. [1]

(Go on to the next page)

SCORE	
	3

31. The water storage system comprises a water storage tank and a circuit which ensures that water does not overflow from the tank. The buzzer will sound when the tank is almost full so that water will stop flowing into the tank from the inlet.

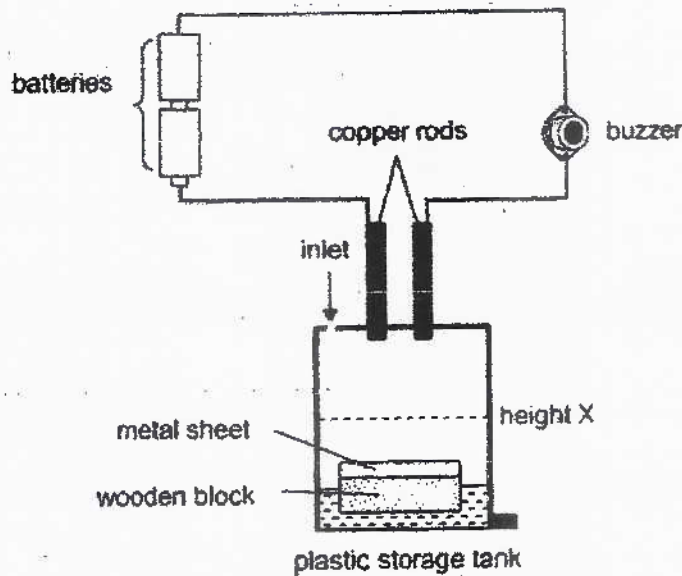

- (a) Describe how the system works such that the buzzer sounds when the tank is almost full of water. [2]

- (b) Without replacing or adding anything to the system, suggest a change to the system so that the buzzer sounds when the water reaches height X. [1]

(continue on the next page)

5

- (c) Add a bulb to the circuit to indicate when the water storage tank is almost full of water. The bulb must light up without decreasing the loudness of the buzzer.

Draw in the part circuit diagram to show how you would connect the bulb. [1]

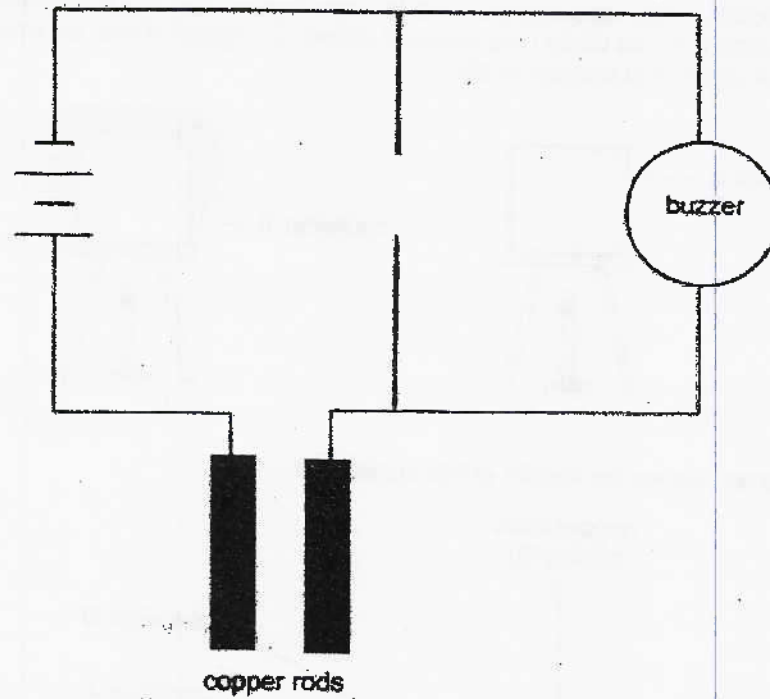

(Go on to the next page)

SCORE	4
-------	---

32. (a) What is temperature?

[1]

Two similar metal containers, A and B, were heated and the temperature of air in each container was taken over a period of time. Container B was covered by a thick layer of cotton with pockets of air.

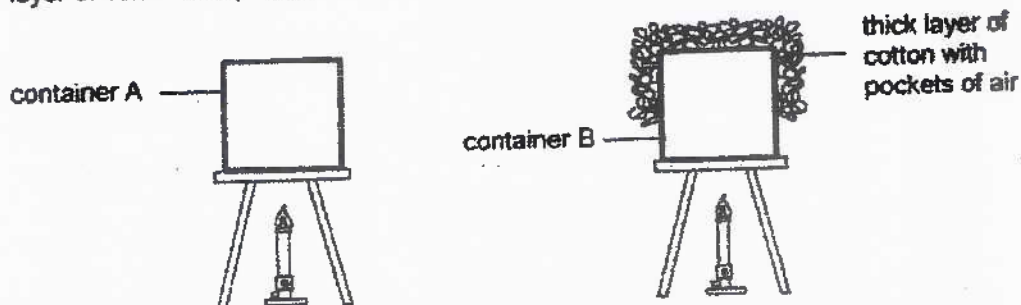

The graph shows the results of the experiment.

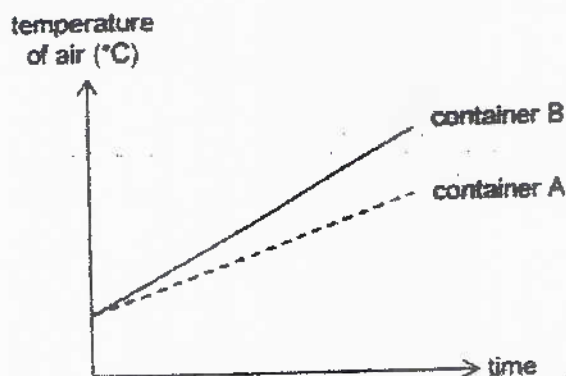

(b) Why does using similar metal containers ensure a fair test?

[1]

(c) Some winter jackets are made with thick layers of cotton. Explain how wearing the jacket helps the person keep warm.

[2]

(Go on to the next page)

SCORE	4
-------	---

33. Kelvin conducted an experiment using the set-up as shown. He released the toy car R from point A.

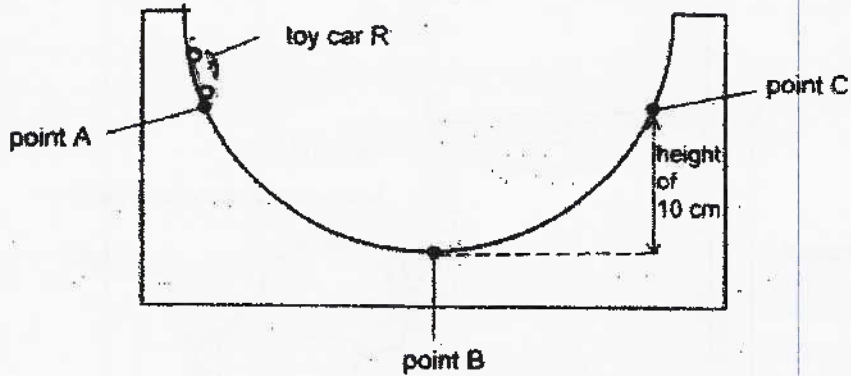

- (a) Toy car R moved past point B but was not able to reach point C. Explain why. [1]

Kelvin repeated his experiment with three other toy cars, S, T and U, and recorded the height reached by the toy car from point B in the table.

Toy car	Mass of toy car (g)	Height reached by toy car (cm)
R	20	6
S	30	7
T	40	8
U	50	9

- (b) What is the relationship between the mass of the toy car and the height reached by the toy car? [1]

- (c) Without replacing or adding anything to the set up, suggest another way to get toy car R to reach point C. Explain your answer [1]

(Go on to the next page)

SCORE	3
-------	---

34. As water from container M flows into container N, it turns the water wheel which is connected to a generator and a light bulb. The bulb lights up after some time.

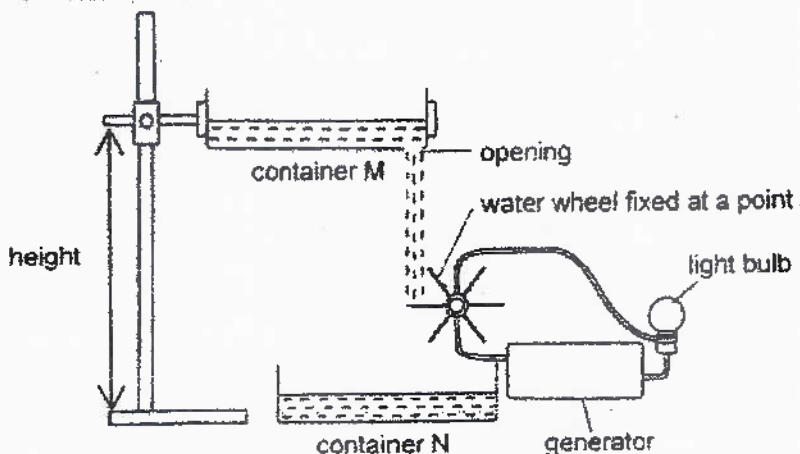

- (a) Fill in the boxes to show the energy conversions. [1]

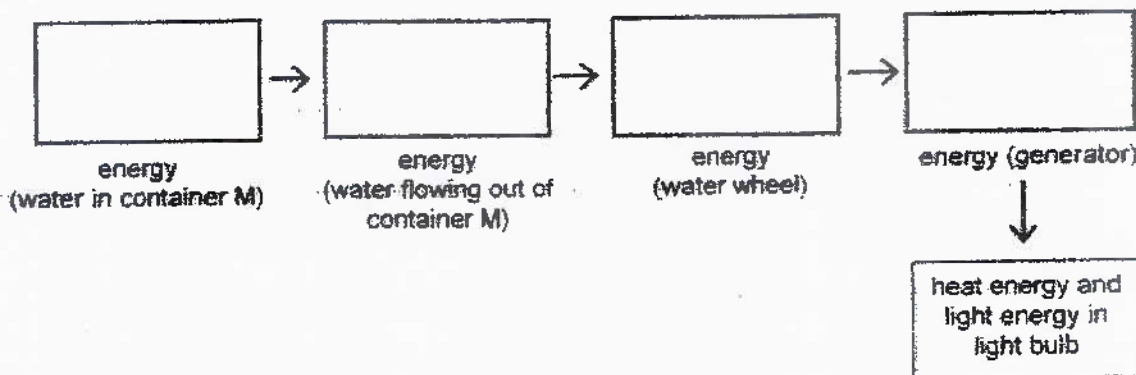

- (b) State two changes that can be made to container M to make the water wheel turn faster. [2]

(Go on to the next page)

SCORE	3
-------	---

35. Tony carried out an experiment using a toy car. He wound up the toy car, released it and measured the distance travelled by the toy car. He repeated the experiment on different types of surfaces, A, B and C.

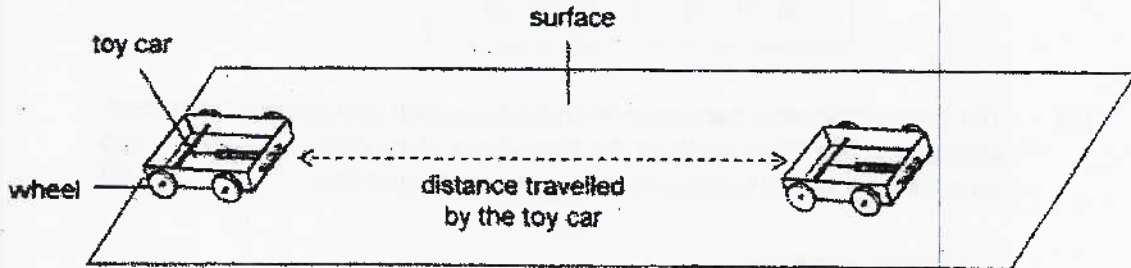

- (a) What was the aim of Tony's experiment? [1]

- (b) Other than the toy car, which two other variables should he keep constant to ensure a fair test? [1]

Tony recorded his results in a table.

Surface	Distance travelled by toy car (cm)		
	1 st try	2 nd try	3 rd try
A	8	9	9
B	10	11	12
C	7	8	7

- (c) Based on the results in the table, what can Tony conclude about surface C? Explain why. [1]

(Go on to the next page)

SCORE	3
-------	---

36. Study the food chain in a habitat.



- (a) The graph shows what happened when the population of organism D increased. Identify the correct line graph for the populations of the different organisms and write the letters A, B, C and D in the boxes next to each line. [2]

Number of organisms

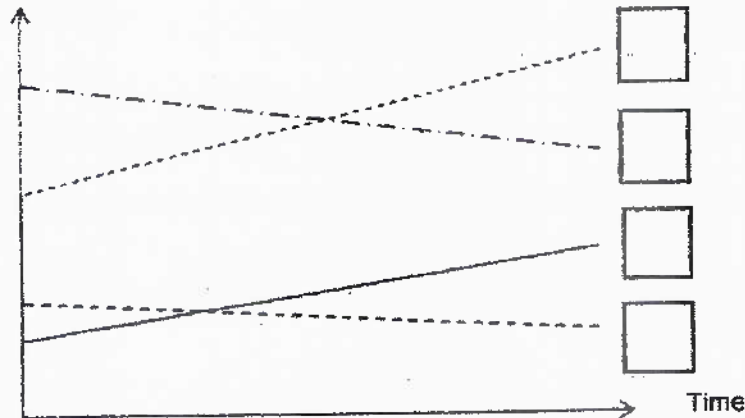

- (b) Due to a disease that only affected organism C, there was a drastic decrease in the population of C.

State two immediate effects to the other populations and explain why. [2]

Effect 1 : _____

Effect 2 : _____

(continue on the next page)

- (c) There are two other food chains that exist in the same habitat as shown.



Construct a food web using all three food chains in the box provided to show the relationships among the organisms based on the food they eat. [1]

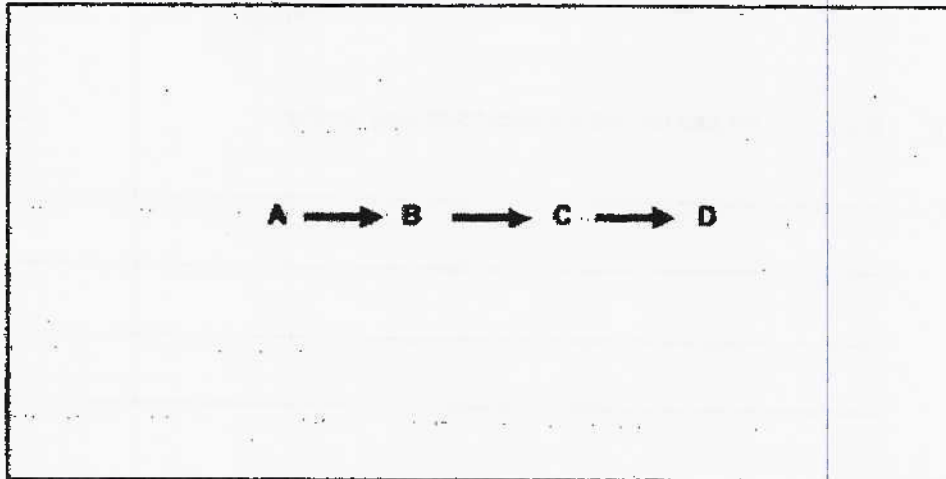

(Go on to the next page)

SCORE	5
-------	---

37. The Egyptian plovers and crocodiles have a unique relationship. The Egyptian plovers will fly into the opened mouth of the crocodiles to eat the food stuck in between the teeth of the crocodiles and then fly away.

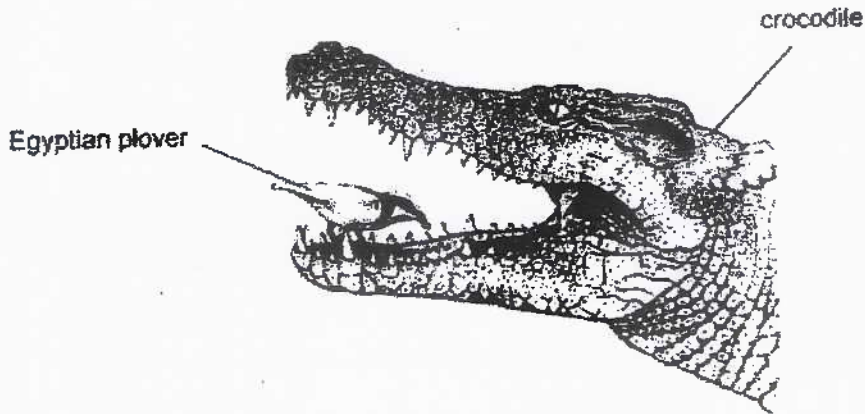

- (a) State how the two organisms depend on one another. [2]

- (b) The rivers in Egypt are drying up. In order to survive, the crocodiles move into artificial water bodies like dams which makes them closer to people. People hunt the crocodiles to protect themselves, as well as use their meat and body parts for medicinal use and food

Explain how the continued hunting of the crocodiles affect the population of the Egyptian plovers over a period of time. [1]

(Go on to the next page)

SCORE	/
	3

38. The diagrams show the life cycles of two organisms P and Q.

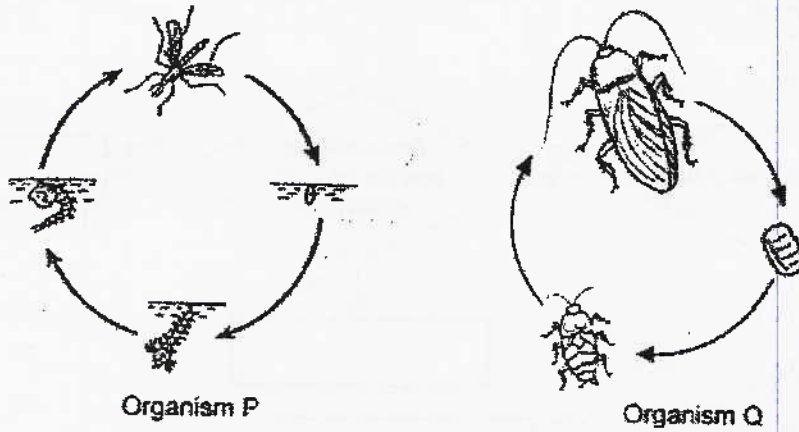

(a) State two differences in the life cycles of organisms P and Q. [2]

Difference 1 : _____

(b) The young of Organism P uses its breathing tube to take in air from the surrounding.

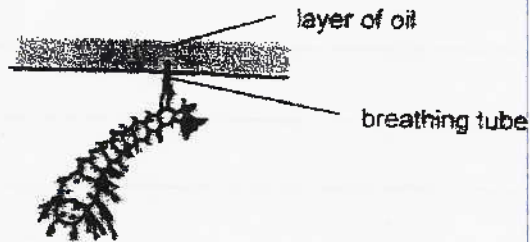

How would spraying a layer of oil on the water surface prevent organism P from breeding? [1]

(Go on to the next page)

SCORE	3
-------	---

39. Sean classified some animals using the flowchart.

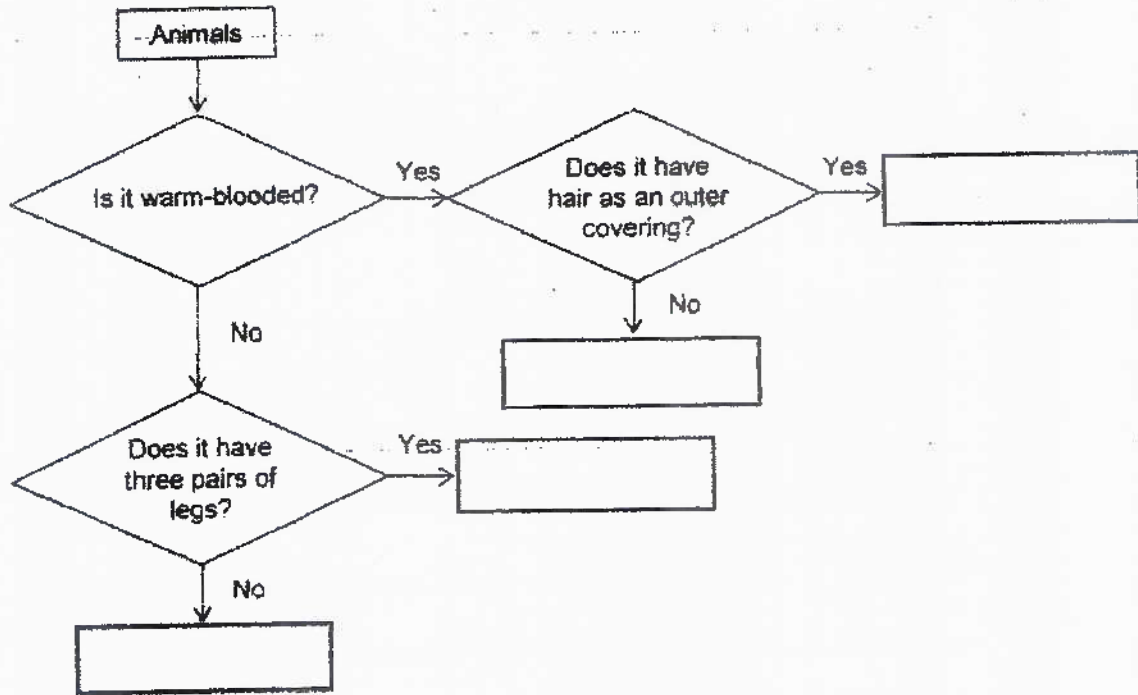

(a) Complete the flowchart by filling in the boxes with the correct animal groups. [2]

(b) Explain how having hair as an outer body covering is an advantage to an animal that lives in a cold habitat. [1]

(continue on the next page)

- (c) Animal X huddle together in tightly packed groups when there is strong cold winds during a snow storm.



Animal X

How does this behavioural adaptation help the animal survive the extreme cold environment? [1]

(continue on the next page)

SCORE	4
-------	---

40 The diagram shows the life cycle of a flowering plant.

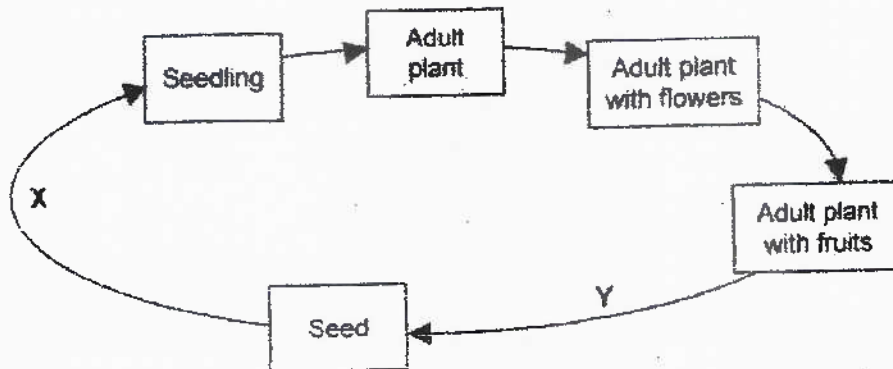

(a) What do letters X and Y represent in the life cycle of the flowering plant? [1]

X _____

Y _____

The table shows the characteristics of three different flowers A, B and C.

Flower	Are the petals colourful?	Does the flower have a sweet scent?	Length of petals (cm)
A	Yes	Yes	8
B	Yes	No	2
C	No	Yes	6

(b) Which flower can best attract pollinators? Explain your answer [1]

(continue on the next page)

(c) Study the flowers, A and C, as shown in the diagram.

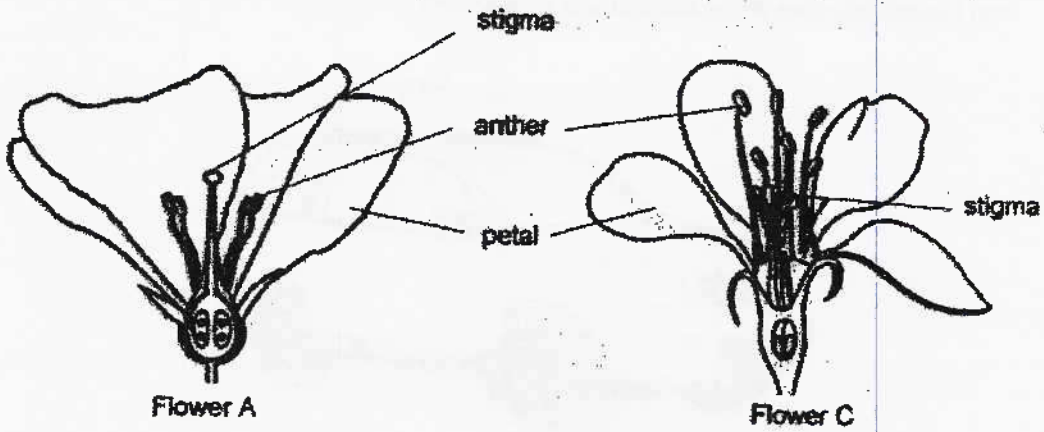

The anthers of Flower C are long and stick out of the flower and its stigma is feathery and exposed. State how Flower C is pollinated. Explain why. [1]

(Go on to the next page)

SCORE	
	3

41. While driving with the windows closed during his recent holiday in winter, Ali noticed that the windows of his car had become misty. The temperature in the car was 22°C and the temperature of the surrounding air was 5°C .

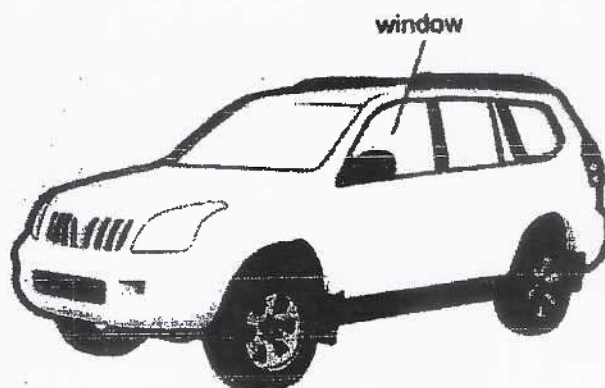

- (a) He observed that water droplets had formed on the inner surface of the car windows. Explain his observation. [2]

- (b) He wound down one of the windows. After a while, water droplets stopped forming on the inner surface of the other windows.

Explain why the water droplets stopped forming after one of the windows was wound down. [1]

End of Paper

SCORE	
	3

ANSWER KEY

YEAR : 2021
LEVEL : PRIMARY 6
SCHOOL : ACS (JUNIOR)
SUBJECT : SCIENCE
TERM : MID-YEAR EXAM

BOOKLET A

Q1	2	Q2	3	Q3	2	Q4	4	Q5	4
Q6	4	Q7	2	Q8	3	Q9	1	Q10	3
Q11	2	Q12	4	Q13	4	Q14	2	Q15	4
Q16	2	Q17	3	Q18	2	Q19	2	Q20	2
Q21	2	Q22	2	Q23	4	Q24	3	Q25	3
Q26	3	Q27	2	Q28	1				

BOOKLET B

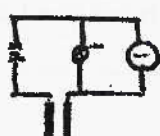
Q29	<p>a) Leaves A and B. The water-carrying tube was cut at part X. So water absorbed by the roots could not be transported to leaves A and B. Without water and food leaves A and B will die.</p> <p>b) The food carrying tube at part Y was cut off. So the food made by leaf C could get collected at the part just above part Y as the food made by leaf C could not be transported below part Y and above part X.</p>
Q30	<p>a) Remove carbon dioxide from the fish</p> <p>b) With more tiny structures, there will be greater surface area of the gills in contact with the dissolved oxygen in the water and hence allow gaseous exchange to carry out at a faster rate hence helping the fish get more dissolved oxygen.</p> <p>c) Plant A gives O₂ during photosynthesis and fish to take in O₂.</p>
Q31	<p>a) The metal sheet will rise and touch the copper rods. A closed circuit is formed and electricity will flow through the circuit and make the buzzer sound.</p> <p>b) Lower the circuit till height X.</p> <p>c)</p> 

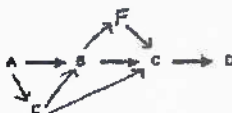
Q32	<p>a) A measure of how hot or cold something is</p> <p>b) To ensure that the difference in the increase of the temperature of the air is only due to the thick layer of cotton with pockets of air.</p> <p>c) Air is a poor conductor of heat so air in the thick layer of cotton with pockets of air slows down heat loss from the person to surrounding air.</p>
Q33	<p>a) Some of the kinetic energy of the car was converted to heat energy and sound energy. Which does not aid in the movement of the toy car R.</p> <p>b) The greater the mass of toy car the greater the height reached by the toy car.</p> <p>c) Release toy car R somewhere higher than point A. To increase the potential energy converted to kinetic energy.</p>
Q34	<p>a) Potential → kinetic → kinetic → electrical</p> <p>b) Increase the size of opening to container M increase the height of which container M is raised from the ground.</p>
Q35	<p>a) To see how the type of surface affects the distance travelled by the toy car.</p> <p>b) The number of times he wound up the toy car.</p> <p>c) Surface C caused the most friction between the wheels of the car and the surface.</p>
Q36	<p>a) BADC</p> <p>b) Effect 1 : decrease in the population size of D as there is less C for D to prey on and hence less food for D. Effect 2 : B will increase in population size. Thus will be less C to prey on B and hence there will be more B.</p> <p>c)</p> 
Q37	<p>a) The Egyptian plover depends on the crocodile for food and protection.</p> <p>b) There will be less food for the plovers got to eat from the crocodiles as there are fewer Crocodiles. This will cause the plover population to decrease over time.</p>
Q38	<p>a) Difference 1 : organism P has a 4-stage life cycle. While organism Q has a 3-stage life cycle. Difference 2 : the young of organism P does not resemble the adult while the young of organism Q resembles its adult.</p> <p>b) The organism will not be able to get O₂ from the surrounding air as the layer of oil blocks respiration.</p>

<p>Q39</p>	<pre> graph TD A[Animal] --> B{Is it warm-blooded?} B -- Yes --> C{Does it have hair or wool covering?} C -- Yes --> D[Mammal] C -- No --> E[Birds] B -- No --> F{Does it have three pairs of legs?} F -- Yes --> G[Insect] F -- No --> H[Reptile] </pre> <p>a) _____</p> <p>b) There is air spaces in between the hair and air is a poor conductor of heat would not be lost from the body of the animal to the surrounding as fast.</p> <p>c) To reduce the surface area of animal X in contact with the cold surrounding so they it would not lose heat faster.</p>
<p>Q40</p>	<p>a) X : Germination Y : seed dispersal</p> <p>b) Flower A. The length of petal is the longest hence will attract insect to the colourful petal for insects to be attracted to the sweet scort of the flower 6 for the pollen grains would be stuck to the inseas bodys for pollination to occur before going to another plant.</p> <p>c) The pollen grain are carried by the wind and transferred to the stigma.</p>
<p>Q41</p>	<p>a) The warmer water vapour in the car would come in contact with the cooler inner surface of the window and lose heat to condense anf form water droplets.</p> <p>b) Temperature in the car surroundings is the same so there is no cooler surface for water vapour to lose heat and condense on.</p>

3
END

