



CATHOLIC HIGH SCHOOL
PRELIMINARY EXAMINATION (2021)
PRIMARY SIX
SCIENCE
BOOKLET A

Name: _____ ()

Class: Primary 6 - _____

Date: 24 August 2021

28 questions

56 marks

Total Time for Booklets A and B: 1 hour 45 minutes

INSTRUCTIONS TO CANDIDATES

Do not turn over this page until you are told to do so.

Follow all instructions carefully.

Answer all questions.

Shade your answers in the Optical Answer Sheet (OAS) provided.

This booklet consists of 20 printed pages, excluding the cover page.

Booklet A (28 × 2 marks)

For each question from 1 to 28, four options are given. One of them is the correct answer. Make your choice (1, 2, 3 or 4). Shade your answer on the Optical Answer Sheet. (56 marks)

- 1 The table below shows the different animal groups and their characteristics.

Characteristic	Animal group			
	Amphibians	Birds	Fish	Reptiles
lays eggs	yes	yes	yes	no
has six legs	no	no	no	yes
breathes through gills	yes	no	yes	no

Which animal groups are **not** classified correctly?

- (1) Birds and Fish only
 (2) Birds and Reptiles only
 (3) Amphibians and Birds only
 (4) Amphibians and Reptiles only
- 2 Which of the following is/are **not** found in the small intestine during digestion?
- A solid waste
 B digested food
 C digestive juices
 D undigested food
- (1) A only
 (2) A and D only
 (3) B and C only
 (4) B, C and D only

3 Study the diagram below.

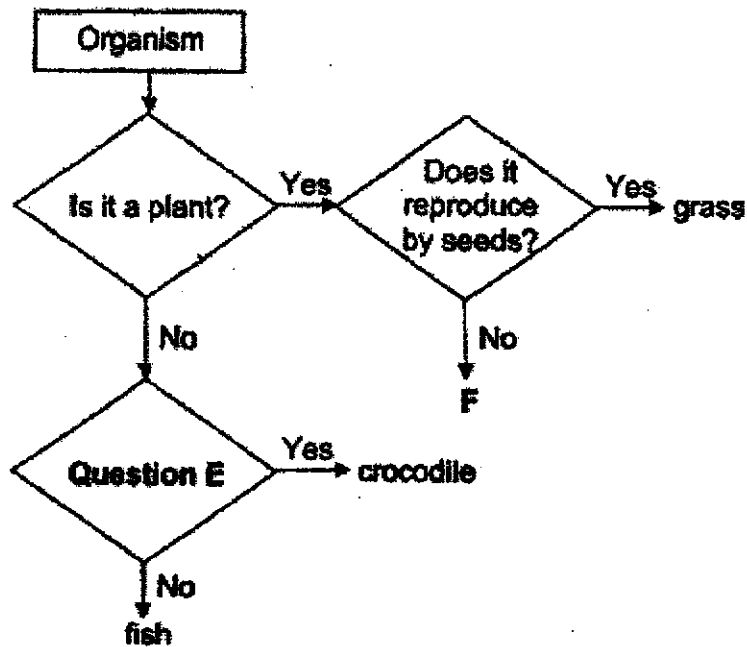

Which of the following represents E and F?

	Question E	F
(1)	Does it have legs?	F is a fungi.
(2)	Does it have a dry scaly skin?	F does not bear flowers.
(3)	Does it breathe through gills?	F reproduces by spores.
(4)	Does it lay eggs?	F does not produce fruits.

4 In what ways are the plant transport system and human circulatory system similar?

- A Both transport food and water.
- B Both have tubes to transport substances.
- C Both transport oxygen and carbon dioxide.
- D Both need an organ to pump the substances to different parts.

- (1) A and B only
- (2) B and D only
- (3) A, B and C only
- (4) A, C and D only

- 5 The diagram below shows the direction of blood flowing in some parts of the body.



The same amount of blood was taken from A, B, C and D.

Which graph shows the correct comparison of the amount of carbon dioxide in the blood samples?

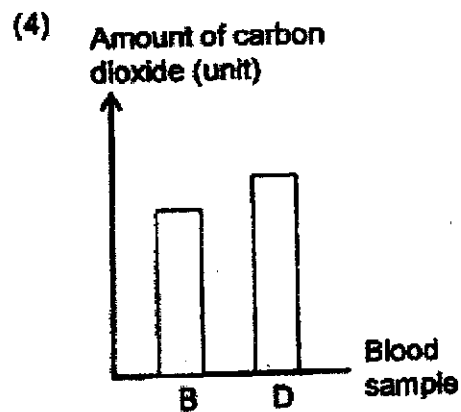
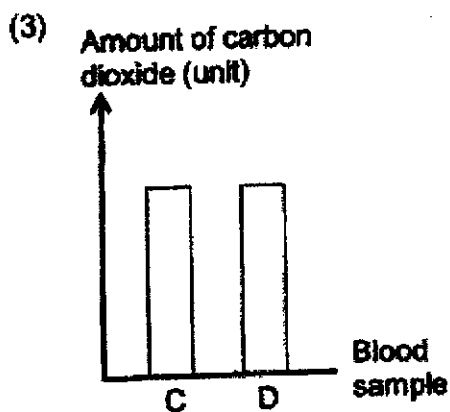
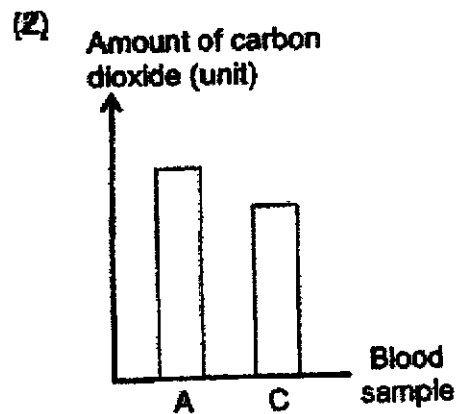
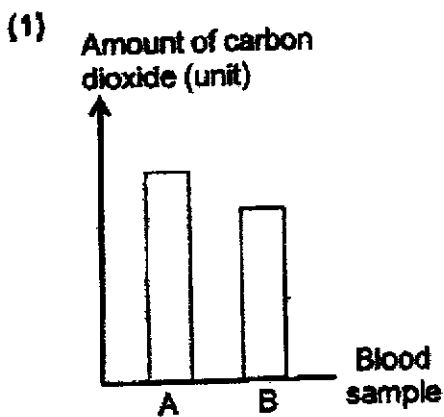

- 6 May wanted to conduct an experiment to find out if plants take in water through their roots.

Which pair of set-ups should she prepare to conduct a fair test?

(1)

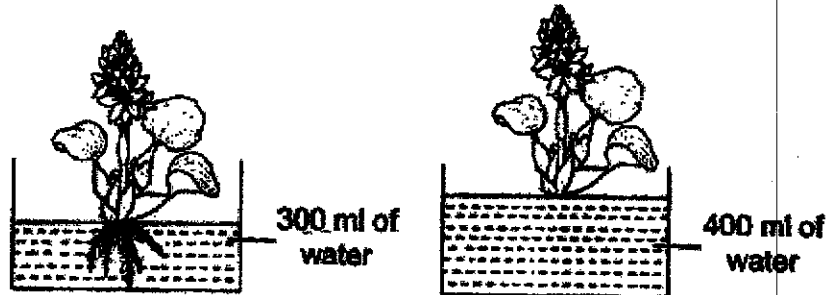

(2)

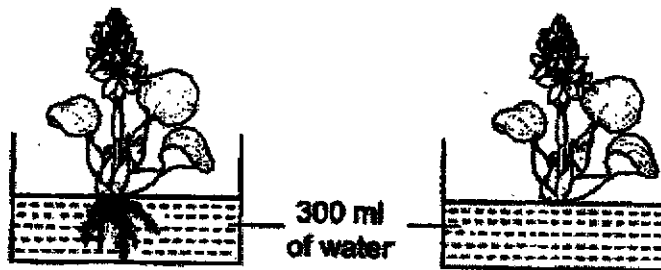

(3)

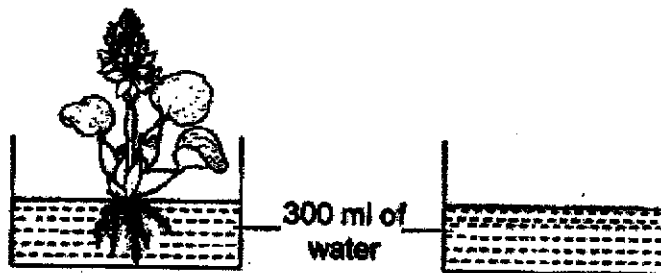

(4)

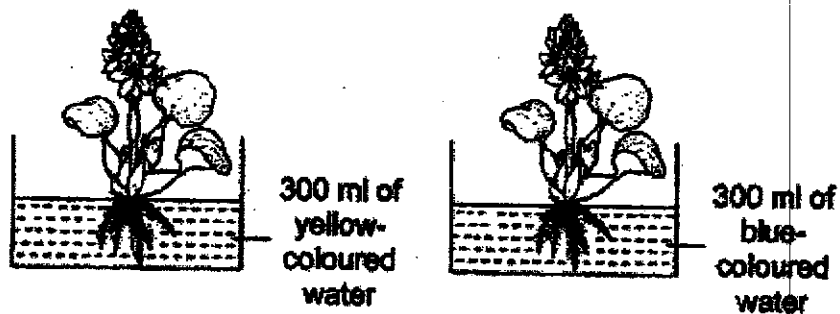

- 7 Joanne put a plant into a beaker of water in which some red ink was added. A few hours later, she observed that the flowers turned from white to red.

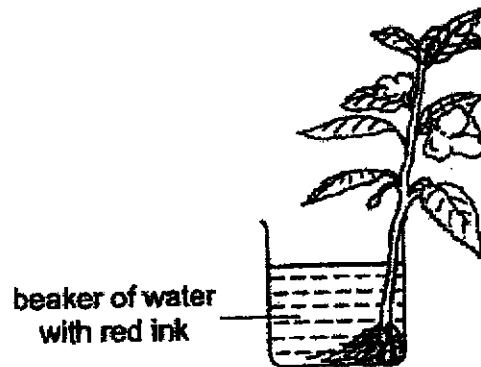

Which
 What of the following explains her observation?

- (1) The leaves made food for the plant.
 - (2) The roots helped the plant to stay upright.
 - (3) The stem joined the roots to the rest of the plant.
 - (4) The stem carried water from the roots to the rest of the plant.
- 8 A group of scientists wanted to produce purple leaves instead of green leaves.

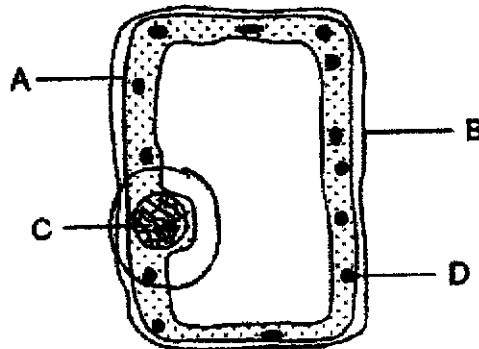

Which part of the leaf cell should the scientists change?

- (1) A
- (2) B
- (3) C
- (4) D

- 9 The table below shows the length of two stages in the life cycle of a mosquito and a cockroach.

Stage	Number of days spent in each stage	
	mosquito	cockroach
egg	5	15
larva / nymph	10	25

At which stage of the life cycle would the insects be on the 12th day after the eggs have hatched?

	mosquito	cockroach
(1)	larva	egg
(2)	larva	nymph
(3)	pupa	adult
(4)	pupa	nymph

(1)

- 10 Darius observed three flowers, X, Y and Z.

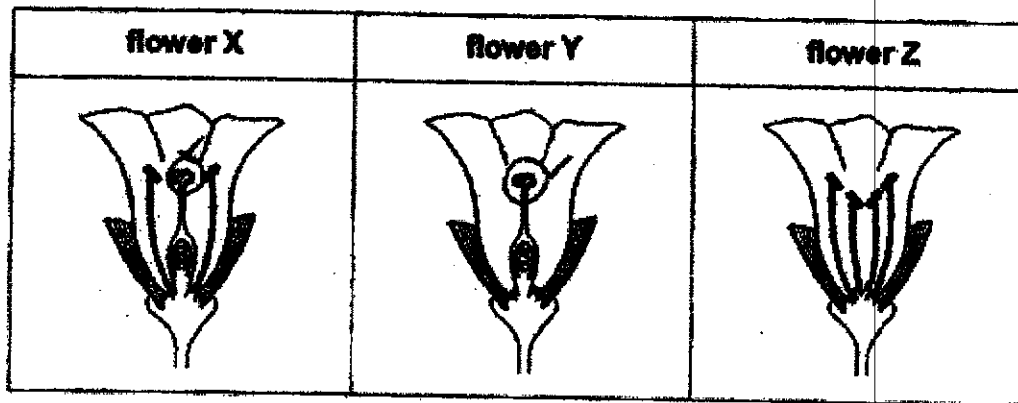

Which flower(s) would develop into a fruit?

- (1) X only
 (2) Z only
 (3) X and Y only
 (4) X, Y and Z

- 11 The diagram below shows the reproductive systems of a human and a plant.

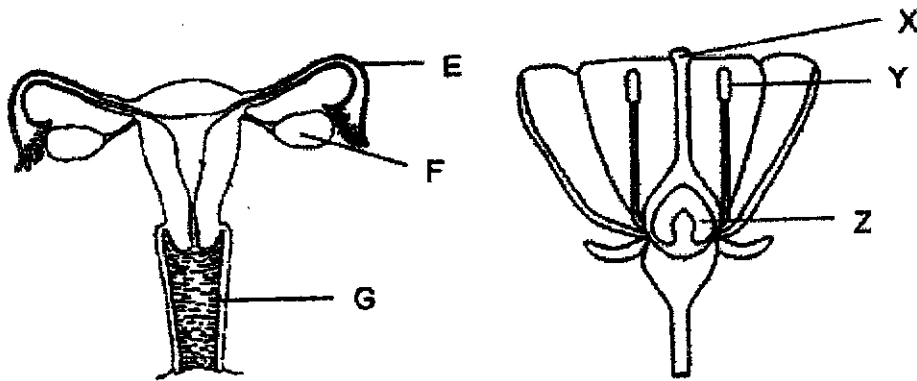

Which statement(s) is/are correct?

- A Fertilisation occurs at parts E and
- B Parts F and Y store reproductive cells.
- C The fertilised egg will develop in parts G and Z.

- (1) B only
- (2) A and B only
- (3) A and C only
- (4) B and C only

- 12 Plant H bears flowers that are bright yellow and give off a sweet smell.

What can we conclude about plant H?

- A The fruits are sweet-smelling.
- B The seeds are dispersed by animals.
- C The flowers are pollinated by insects.

- (1) A only
- (2) C only
- (3) A and B only
- (4) A, B and C

- 13 Phyllis wanted to find out if the different times of the day affect the amount of carbon dioxide water plants produced. She prepared the set-up as shown in the diagram below.

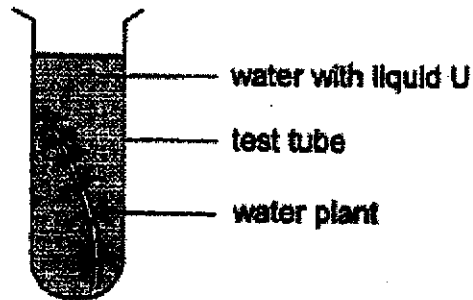

She placed the set-up near the window and added a few drops of liquid U to the water. Liquid U changed colour as shown in the table below.

Amount of carbon dioxide in water	less than normal	normal	higher than normal
Colour of water with liquid U	purple	yellow	orange

What colour would the water with liquid U be at midday and at midnight?

	At midday	At midnight
(1)	yellow	orange
(2)	yellow	purple
(3)	purple	orange
(4)	orange	purple

- 14 The diagram below shows a well-watered plant placed next to an open window. The plant has leaves that are green in the centre and white around the edges. The white areas of the leaves do not produce oxygen when exposed to sunlight.

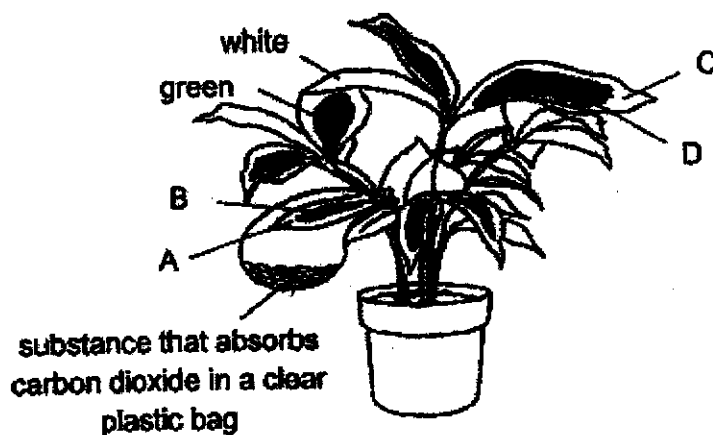

Which two areas of the leaves lack only one condition needed for photosynthesis to take place?

- (1) A and C
- (2) A and D
- (3) B and C
- (4) B and D

15 Study the diagram below.

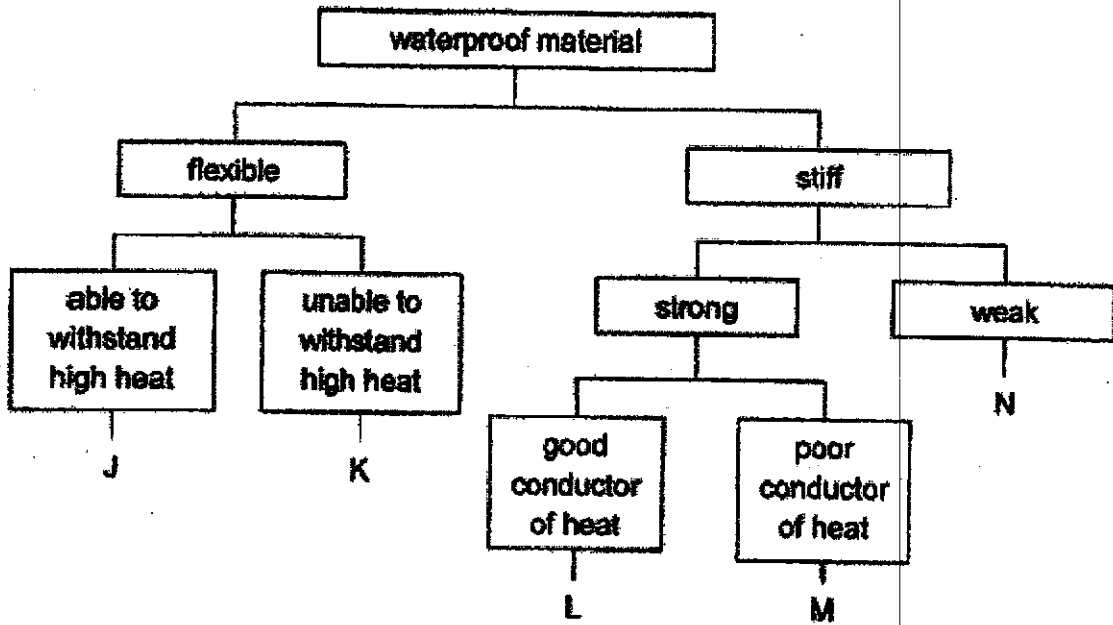

Which materials should be chosen to make helmets and boots for firefighters?

	helmets	boots
(1)	L	K
(2)	M	J
(3)	J	M
(4)	K	N

16 The statements below describe the properties of a substance.

- At 15°C, it has a definite volume and shape.
- At 44°C, it has a definite volume but no definite shape.
- At 125°C, it can be compressed.

Which substance, P, Q, R or S, best represents the substance described above?

	Substance	Freezing point (°C)	Boiling point (°C)
(1)	P	10	131
(2)	Q	17	118
(3)	R	43	181
(4)	S	80	218

17 The mass of a sealed plastic bag of air was measured at the start of an experiment using an electronic balance. The bag was then put under the sun for four hours before it was placed on the balance to be measured again.

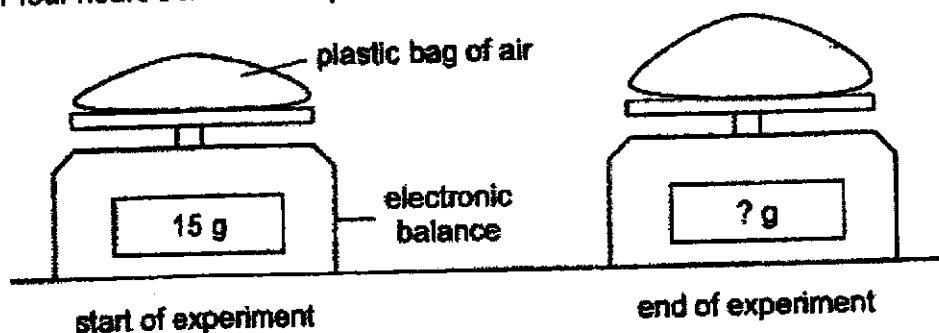

Which statement(s) about the set-up at the end of the experiment is/are correct?

- A The air in the plastic bag expanded.
 B The mass of air in the plastic bag increased.
 C The volume of air in the plastic bag increased.
 D The reading on the electronic balance remained the same.

- (1) D only
 (2) B and C only
 (3) A, B and C only
 (4) A, C and D only

- 18 Study the diagram below. Rashid can see the stool in the presence of light.

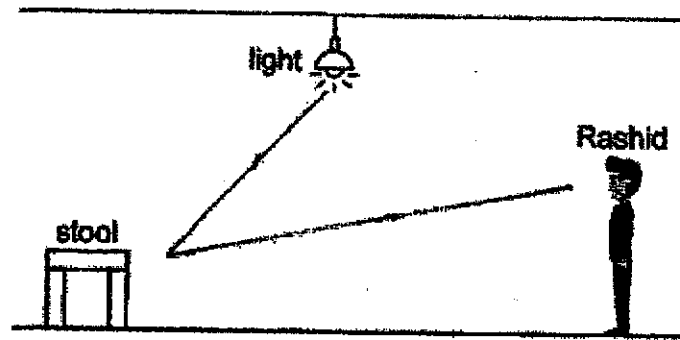

Which of the following correctly shows the path of light that makes it possible for Rashid to see the stool?

- (1) from stool to Rashid to light
 - (2) from stool to light to Rashid
 - (3) from light to stool to Rashid
 - (4) from light to Rashid to stool
- 19 Ravi conducted an experiment using four set-ups with beakers each containing an equal volume of water at the start of the experiment.

At the end of the experiment, he recorded his results as shown below.

Set-up	Exposed surface area of beaker (cm ²)	Wind	Temperature (°C)	Volume of water left in beaker (ml)
W	70	present	36	150
X	100	present	29	165
Y	70	present	29	170
Z	100	absent	36	160

Which two set-ups support the hypothesis, "The greater the temperature of surroundings, the lesser the volume of water left in the container."?

- (1) W and Y
- (2) W and Z
- (3) X and Y
- (4) X and Z

20 Su Fen placed an ice cube on material X in set-up A and a similar ice cube on material Y in set-up B. Both materials X and Y were at room temperature at the start of the experiment.

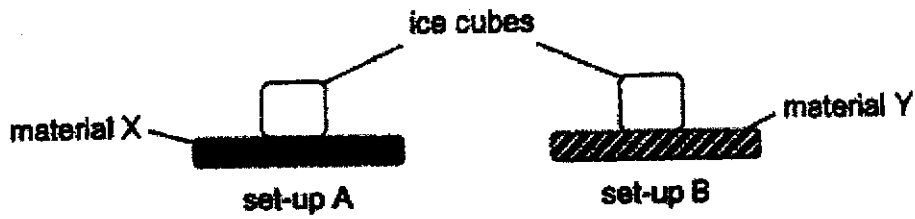

She recorded the time taken for each ice cube to melt and reach room temperature. The graph below shows the results of her experiment.

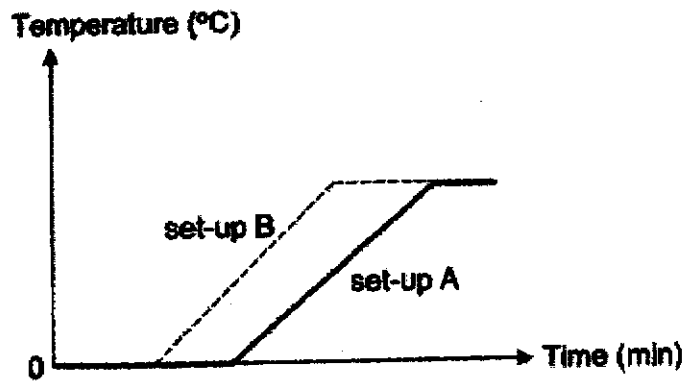

Su Fen wanted to bring hot food and cold drinks for an outing. She wanted to ensure that the food stayed hot and the drinks remained cold in the containers.

Which materials would be more suitable for the containers?

Material for container carrying		
	hot food	cold drinks
(1)	X	Y
(2)	X	X
(3)	Y	X
(4)	Y	Y

- 21 50 ml of water was poured into two identical cups, X and Y. The two cups of water were weighed on a digital scale and placed in a location at room temperature.

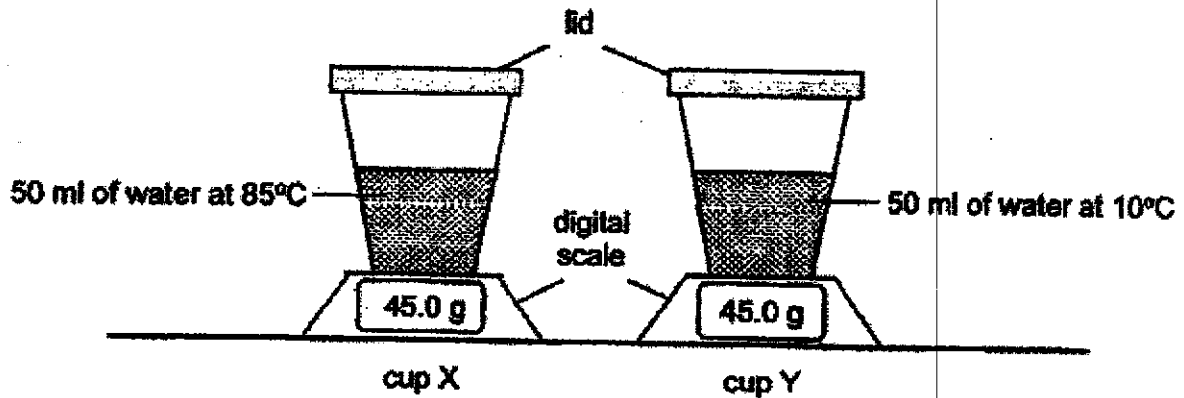

After some time, water droplets were observed to form on the lids and the cups.

Which of the following correctly shows the mass of the cups after some time?

Mass of cup after half an hour (g)	
cup X	cup Y
(1) less than 45.0 g	more than 45.0 g
(2) less than 45.0 g	remained the same
(3) remained the same	remained the same
(4) remained the same	more than 45.0 g

22 Each of the circuits below has an iron rod, a wooden rod and a plastic rod.

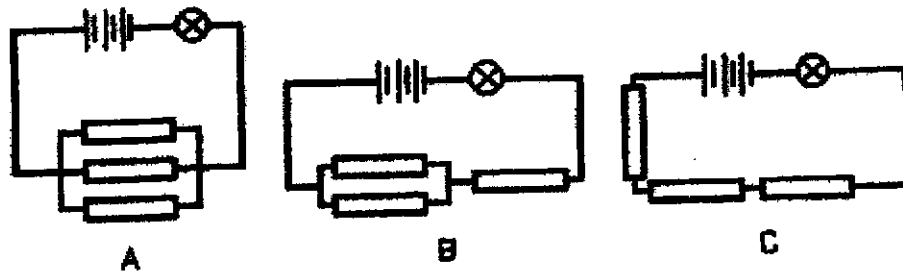

In which of the above circuits will the bulb light up?

- (1) A only
- (2) C only
- (3) A and B only
- (4) None of the circuits

23 Tian Meng constructed a circuit with two batteries, three bulbs and two switches. Identical components were used.

He closed one of the two switches and found that all three bulbs lit up.

Which is not a possible circuit constructed by Tian Meng?

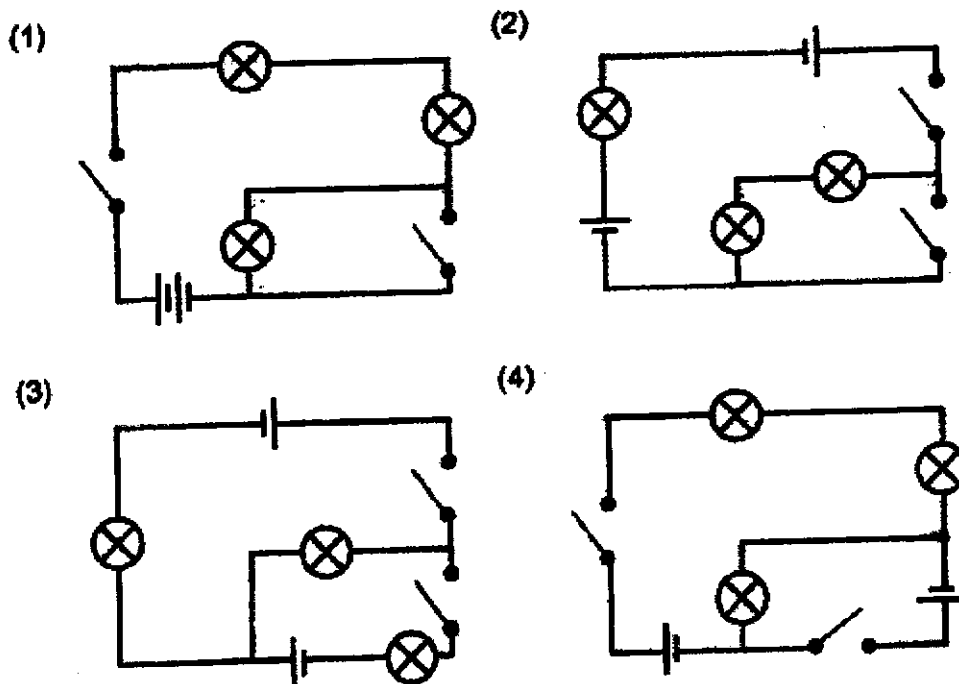

- 24 Seetha set up an experiment as shown below. She pulled the elastic band backwards and upon releasing the band, the pebble shot from A and hit the box off the stand at B. The box then fell from B to C.

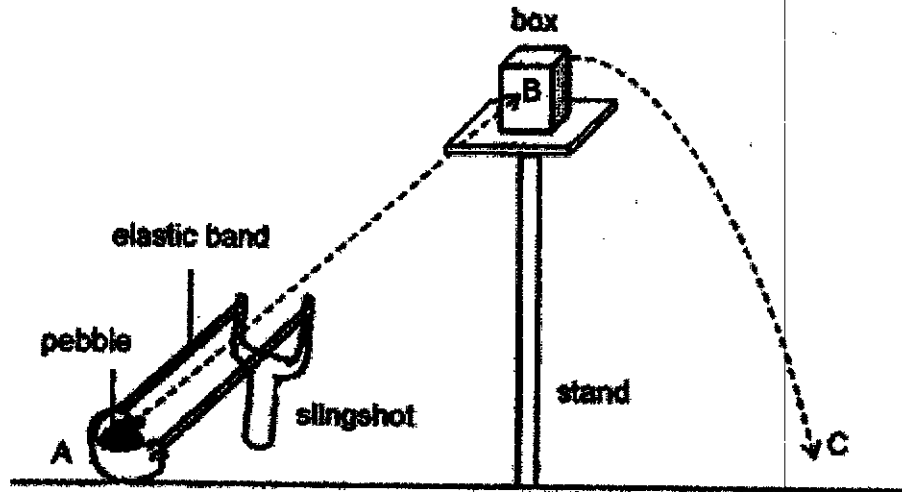

Which of the following correctly shows how the amount of energy possessed by the pebble and the box change?

	Potential energy of pebble from A to B	Kinetic energy of box from B to C
(1)	decreased	increased
(2)	decreased	decreased
(3)	increased	increased
(4)	increased	decreased

- 25 Block Z was moved from a stationary position at point E to point G and beyond as shown below.

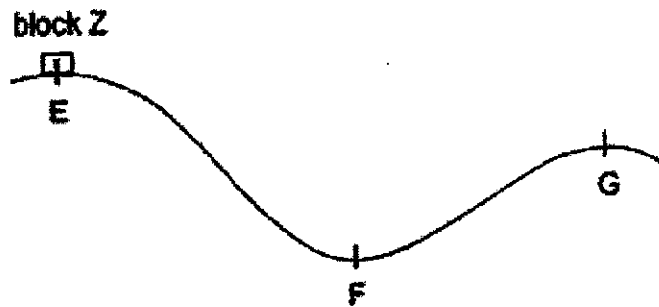

After carrying out the above action numerous times, it was observed that tiny bits of block Z broke off as it moved along point E to beyond point G.

Based on the information above, which statements are correct?

- A A force exerted on block Z caused it to move.
- B Kinetic energy of block Z increased from points F to G.
- C Frictional force caused block Z to undergo wear and tear.
- D The gravitational force acting on block Z decreased from points E to F, then increased from points F to G.

- (1) A and C only
- (2) B and D only
- (3) A, B and C only
- (4) A, C and D only

- 26 The diagram below shows a girl about to swing the bat to hit a ball.



Which of the following are most likely to happen after she hits the ball?

- A The ball changes speed.
 - B The ball changes direction.
 - C The ball stops immediately.
 - D The ball decreases in mass.
-
- (1) A and B only
 - (2) B and C only
 - (3) C and D only
 - (4) A, B, C and D

- 27 Study the set-up below. Pete conducted an experiment with four bar magnets, E, F, G and H, of different sizes.



He moved the magnet towards the pins and recorded the greatest distance, d , at which each magnet would attract some pins.



His results are shown in the table below.

Magnet	d (cm)
 E	6
 F	7
 G	4
 H	5

Based on the results above, what can Pete infer from his experiment?

- A Only magnet H can attract pins 5 cm away.
- B Magnet F has greater magnetic strength than magnet E.
- C The greater the size of the magnet, the stronger the magnet.
- D Magnet H can attract more pins than magnet G when the pins are placed the same distance away from them.

- (1) A and B only
- (2) B and C only
- (3) B and D only
- (4) A, C and D only

- 28 Jacelyn conducted an experiment using four springs, A, B, C and D, each of equal length when unstretched.

She hung a metal rod Z from two of the springs at an equal distance apart. The results of her experiment are shown below.

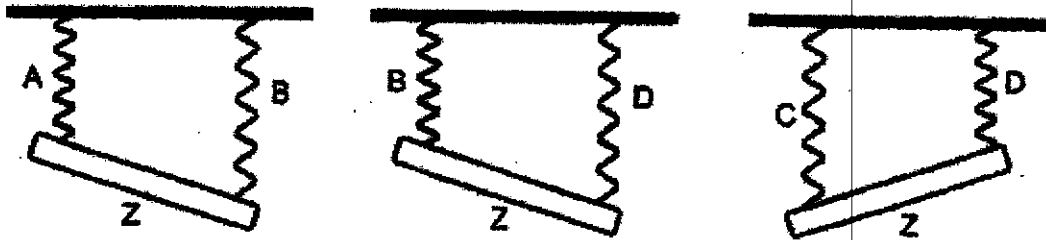

In another experiment, she hung four equal masses from each of the springs.

Which of the following correctly represents how the four springs would be stretched?

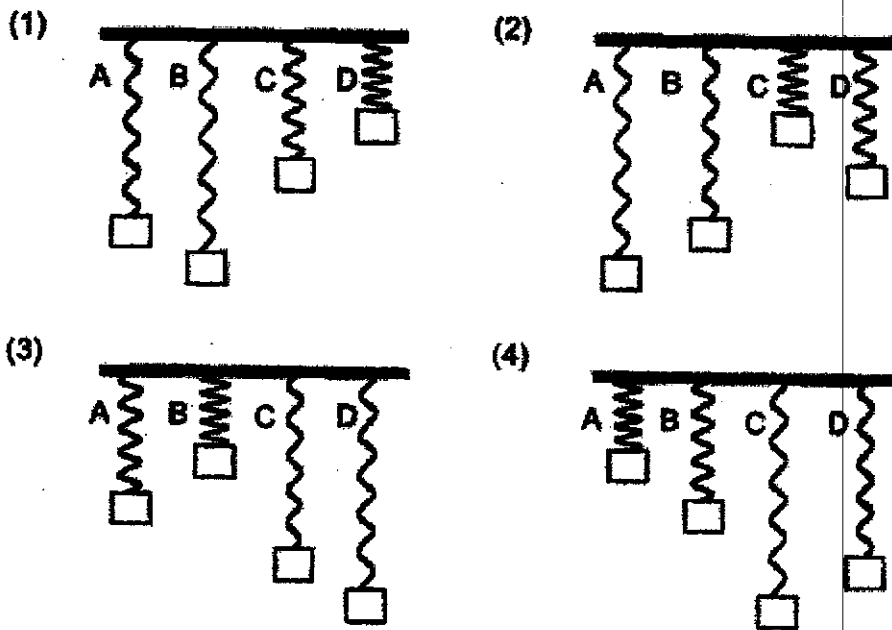

End of Booklet A



CATHOLIC HIGH SCHOOL
PRELIMINARY EXAMINATION (2021)
PRIMARY SIX
SCIENCE
BOOKLET B

Name: _____ ()

Class: Primary 6 - _____

Date: 24 August 2021

Parent's Signature: _____

Booklet A	56
Booklet B	44
Total	100

12 questions

44 marks

Total Time for Booklets A and B: 1 hour 45 minutes

INSTRUCTIONS TO CANDIDATES

Do not turn over this page until you are told to do so.

Follow all instructions carefully.

Answer all questions.

Write your answers in this booklet.

This booklet consists of 19 printed pages, excluding the cover page.

Booklet B (44 marks)

For questions 29 to 40, write your answers in this booklet.

The number of marks available is shown in brackets [] at the end of each question or part question. (44 marks)

- 29 An experiment was conducted to find out the effect of sit-ups on the heart rate of Primary 6 pupils. The heart rate of one pupil was measured before and immediately after doing the sit-ups.

The results of the experiment are shown in the table below.

Number of sit-ups performed	Heart rate (beats per min)			
	1 st reading	2 nd reading	3 rd reading	Average
0	93	90	93	92
25	115	110	114	113
50	134	130	132	132

- (a) State the relationship between the average heart rate and the number of sit-ups performed. [1]

- (b) The pupil rested for 15 minutes before repeating the experiment. Explain why this step is necessary. [1]

(Go on to the next page)

SCORE	2
-------	---

Continue from Question 29

- (c) The pupil observed that his breathing rate also increased when he was doing the sit-ups. Explain why his breathing rate increased. [1]

Before doing the sit-ups, the pupil ate a banana.

- (d) Describe how the digestive system worked with the circulatory system to allow the pupil to perform the sit-ups. [1]

(Go on to the next page)

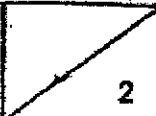
SCORE	
-------	---

- 30 Abel removed the outer ring of a stem as shown in the diagram below. As a result, the food-carrying tubes in this stem were removed.

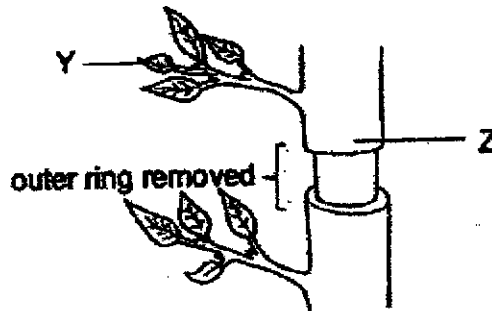

Give an explanation for each of his observations.

- (a) (i) Observation: Part Y remained healthy. [1]

Explanation: _____

- (ii) Observation: Part Z swelled up. [1]

Explanation: _____

- (b) Complete the diagram below by drawing arrows (→) to show how water is transported in a flowering plant. [1]

Leaf

Root

Stem

Flower

(Go on to the next page)

SCORE	3
-------	---

- 31 Plant P has many tiny flowers growing on a stalk, protected by a large, red petal-like leaf.

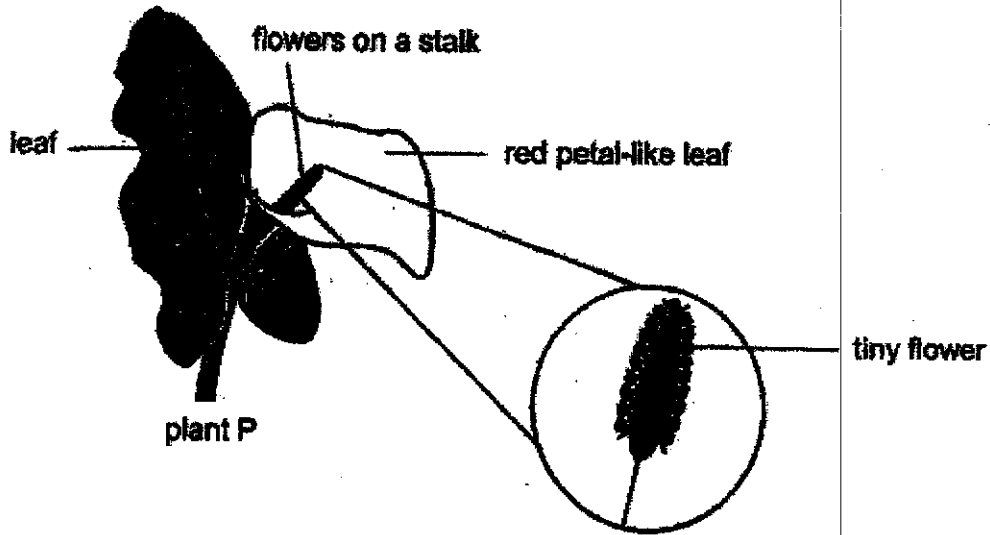

- (a) State an advantage of having many tiny flowers growing on one stalk instead of one flower. [1]

Fruit bats have been observed to feed on the small berry-like fruits of plant P and pass out the seeds in their droppings.

- (b) State an advantage of this method of dispersal. [1]

- (c) State what fertilisation means. [1]

(Go on to the next page)

SCORE	3
-------	---

32 The diagram below shows plant Z.



(a) State the part of the flower where the part of plant Z developed from. [1]

Part of plant Z	Part of flower
pod	
bean	

The diagram below shows the life cycle of plant Z.

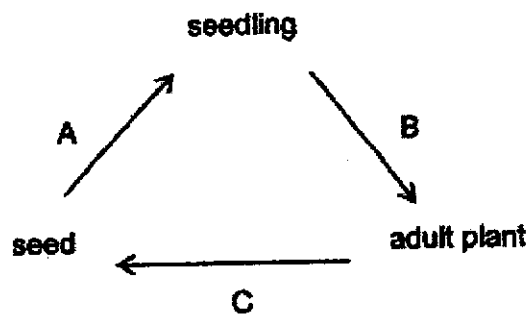

(b) State all the conditions needed for process A to take place. [1]

(Go on to the next page)

SCORE	2
-------	---

Continue from Question 32

The diagram below shows the locations of some young plants X after being dispersed away from parent plants X.

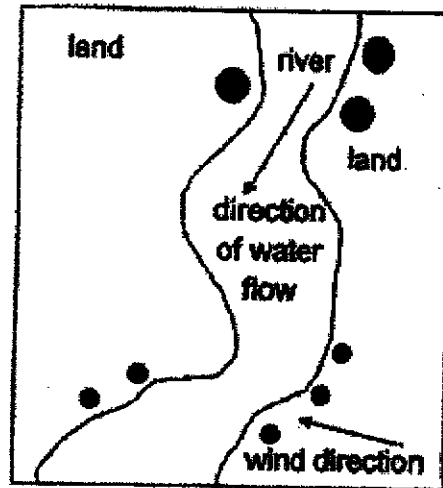

Key

- parent plant X
- young plant X

- (c) Identify a characteristic of the fruit of X and explain how it helps in its dispersal.

[1]

(Go on to the next page)

SCORE	1
-------	---

- 33 Jane wanted to investigate the effect of coloured lights on the rate of photosynthesis. She prepared small discs cut out from leaves of a plant and exposed them to blue and red light as shown in the diagram below.

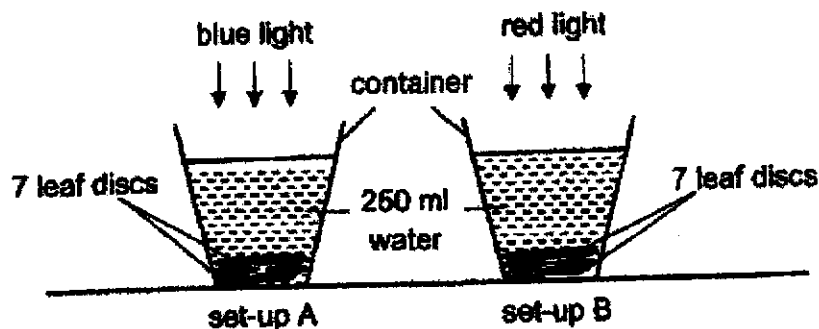

After some time, she noticed bubbles appearing on the surfaces of the leaf discs. As the bubbles rose, the leaf discs were pushed up and floated on the water. The time taken for all the leaf discs to float is recorded in the table below.

Set-up	Time taken for the leaf discs to float (min)
A	10
B	8

- (a) In order for the experiment to be fair, state one other variable that Jane has to keep constant. [1]

- (b) What can Jane conclude from the results above? [1]

(Go on to the next page)

SCORE	2
-------	---

Continue from Question 33

- (c) Suggest a control set-up to improve her experiment further. You may use a diagram OR describe the control set-up in your answer.

[1]

Jane set up another experiment as shown in the diagram below. She covered three similar leaves in different types of plastic bags. The plastic bags were of the same size. She left the plant under the sun for a few hours.

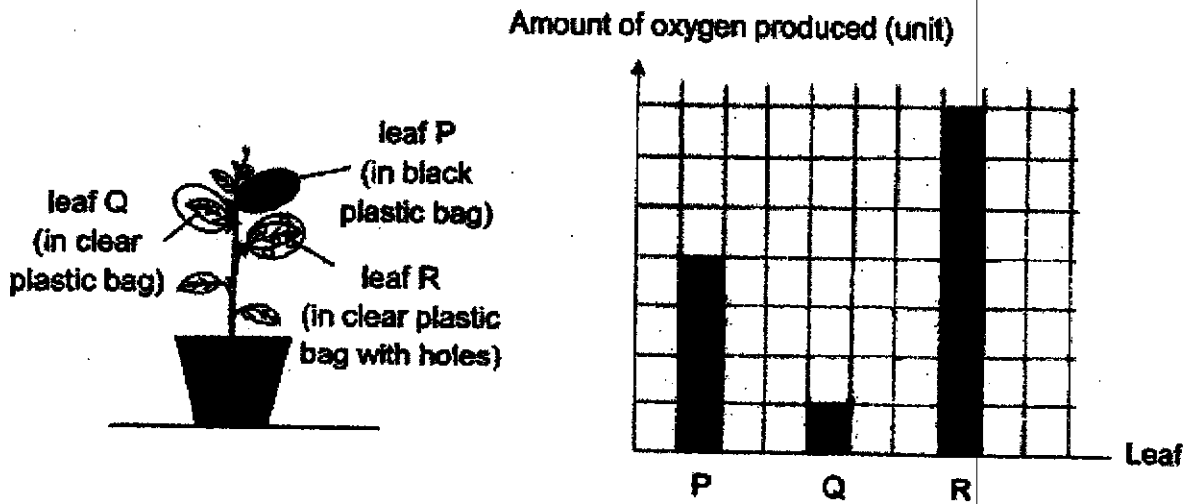

- (d) Complete the bar graph above to show the amount of oxygen produced by leaves P and Q in each plastic bag after several hours. [1]

(Go on to the next page)

SCORE	2
-------	---

- 34 Rita wanted to find out which material would be best for reducing the most amount of sound passing through it.

She placed an electronic bell inside a box that would ring at regular intervals. She recorded the sound level using a sound sensor placed outside the box as shown below.

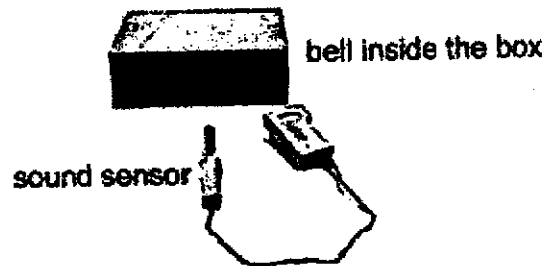

Next, she lined the insides of the box with different materials and recorded her results.

Type of material	Sound level outside the box (unit)
no material added	65
P	40
Q	58
R	50
S	35

- (a) Describe the purpose of using a set-up with no material lining the insides of the box. [1]

- (b) Suggest how using materials of similar thickness allowed for a fair test. [1]

(Go on to the next page)

SCORE	2
-------	---

Continue from Question 34

Rita's parents wanted to reduce the sound level that could be heard outside the house when she played the piano in her room.

- (c) Based on her results in the table, which material is most suitable to line the walls of her room? Give a reason.

[1]

(Go on to the next page)

SCORE	
-------	---

- 35 Sofia wanted to conduct an experiment with ice cubes. She took out a container of ice cubes from the freezer and observed that there was 'white mist' appearing above them as shown below.

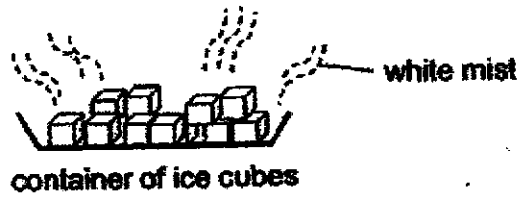

- (a) Explain how the 'white mist' was formed above the ice cubes. [2]

In winter, substance T is put on the road to make ice melt.

Sofia conducted an experiment by putting the same amount of ice cubes in two funnels and adding substance T to the ice cubes in the funnel of set-up B.

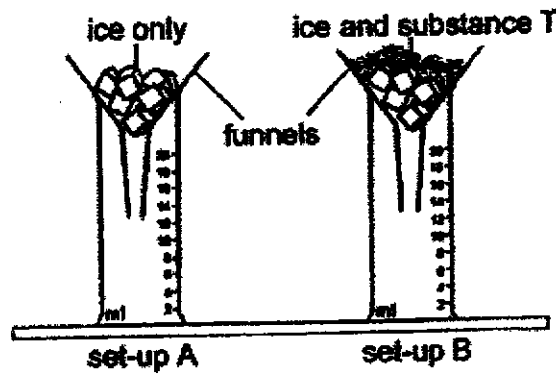

(Go on to the next page)

SCORE	2
-------	---

Continue from Question 35

The ice cubes started to melt. Sofia measured the amount of water in each set-up every ten minutes. Her results are shown below.

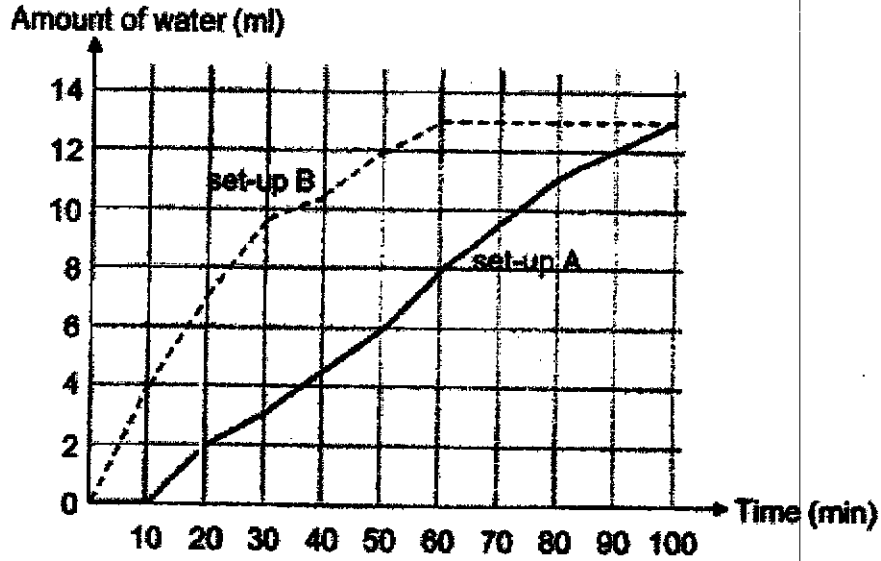

- (b) Based on the graph, what was the effect of substance T on the melting of ice? [1]

Sofia said that she was able to conclude the effect of more substance T on the melting of ice.

- (c) Her results in the graph did not support her conclusion. Suggest what she should do to arrive at her conclusion. [1]

(Go on to the next page)

SCORE	2
-------	---

- 36 Imran built a puzzle circuit with identical batteries and bulbs, E, F, G and H. He covered the connections to the bulbs with a card as shown below. The bulbs could be seen through holes in the card.

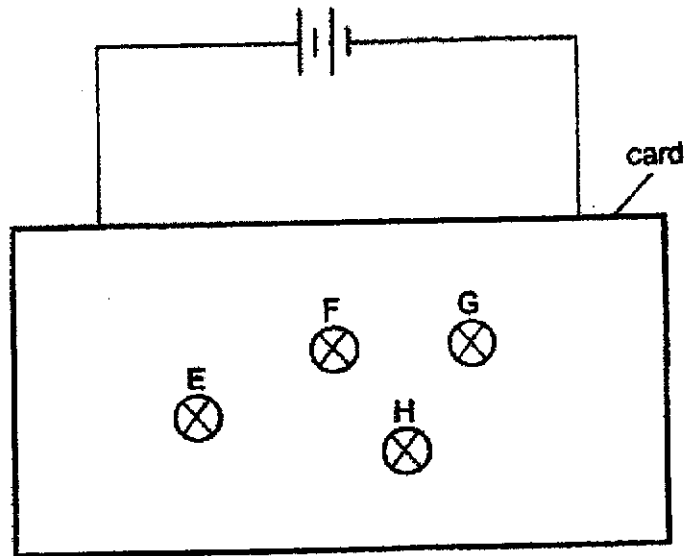

All the bulbs lit up when the circuit was closed but their brightness was different.

He then removed one bulb from the circuit each time and observed what happened to the rest of the bulbs. His observations are recorded in the table below.

Bulb removed	Bulb(s) lit
E	None
F	E and H
G	E and H
H	E, F and G

Continue from Question 36

- (a) Complete the circuit diagram below to show how the four bulbs could be connected.

[2]

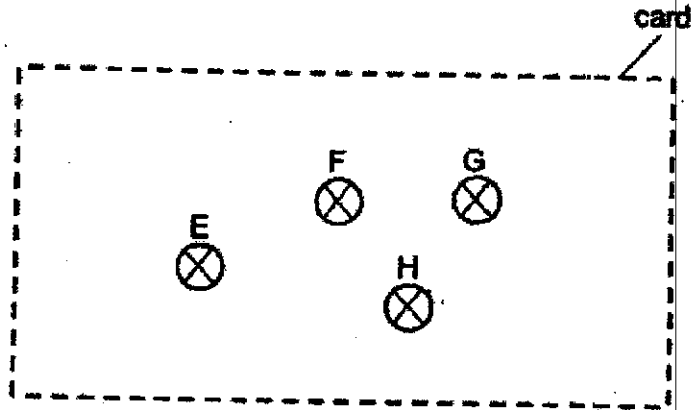

Imran added a switch to the electric circuit in (a) so that he could turn off all the four bulbs at the same time.

- (b) Write the letter 'S' in the circuit diagram in (a) to show where the switch could be added.

[1]

Imran constructed a circuit using identical batteries, bulbs and switches.

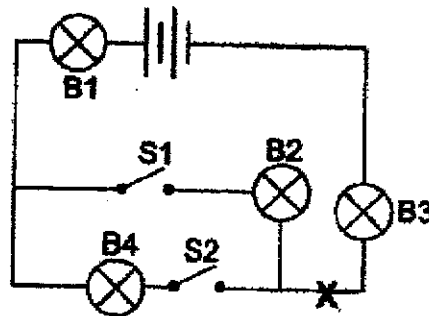

- (c) If only S1 was closed, what would happen to the brightness of B1, B2 and B3 if he added another bulb at the position marked 'X' in the circuit diagram above? Give a reason.

[1]

(Go on to the next page)

SCORE	4
-------	---

- 37 In an experiment, Jovan placed two identical beakers containing the same amount of water at room temperature on two trays of ice as shown below.

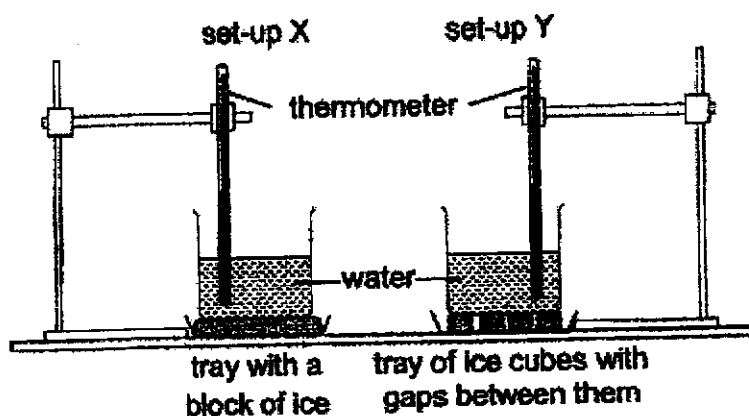

- (a) In which set-up, X or Y, would the temperature of water drop faster? Explain why. [2]

Jovan then placed bottles of tea in a tub of ice cubes as shown below.

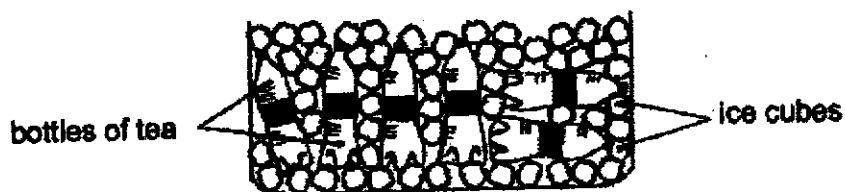

- (b) Using the findings from his experiment, suggest what he could do to cool the bottles of tea more quickly. [1]

(Go on to the next page)

SCORE	3
-------	---

38 The diagram on the right below shows the top view of a pinball machine.

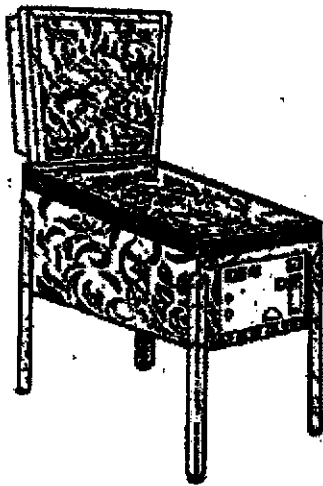

a pinball machine

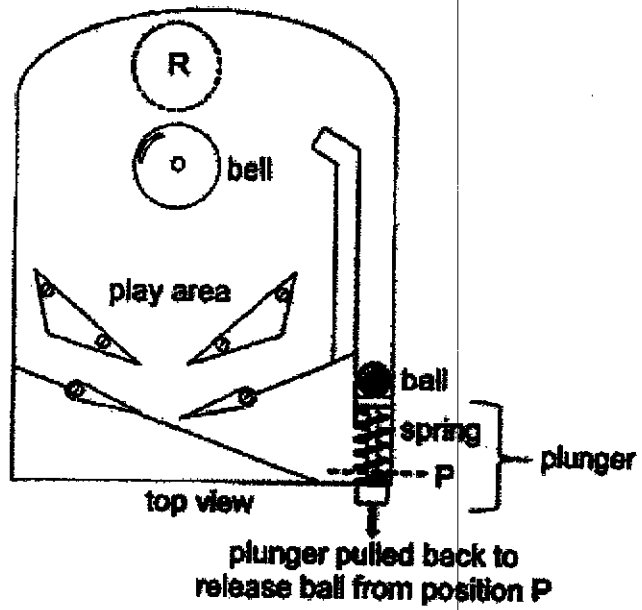

The plunger is pulled back to position P to propel the ball into the play area. The player scores more points if the ball hits the bell on its way into the play area.

- (a) When the plunger is pulled back to position P and released, the ball hits the bell. Explain, in terms of energy changes, why this is so. [2]

The bell is then moved to position R. It is observed that the ball could not hit the bell when the plunger is pulled back to position P.

- (b) Suggest what could be done to the plunger so that the ball is able to hit the bell at R. Give a reason. [2]

(Go on to the next page)

SCORE	4
-------	---

- 39 The diagram below shows how a car, travelling on a road, moves a short distance after the driver steps on the brakes for the car to come to a complete stop. This is called 'braking distance'.

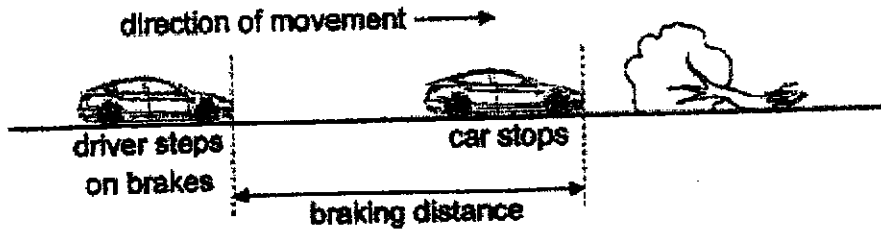

Julia conducted an experiment to find out how the type of surface affects the braking distance of a car.

She rolled a rubber ball over four different surfaces, A, B, C and D, and recorded the time taken for the ball to come to a stop as shown in the graph below.

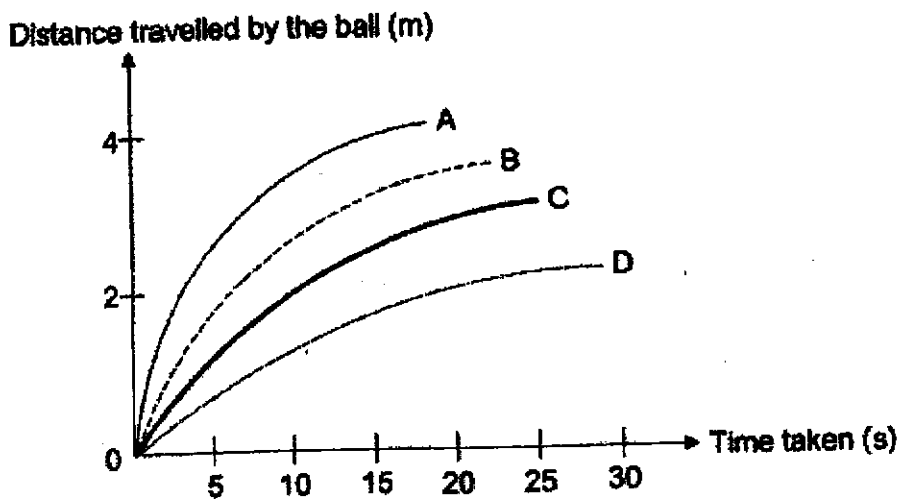

- (a) Based on the graph, on which surface, A, B, C or D, would the braking distance of the car be the shortest if the car travelled at the same speed? Explain why. [2]

(Go on to the next page)

SCORE	2
-------	---

Continue from Question 39

(b) State two variables that Julia needed to keep constant for the experiment. [2]

(i) _____

(ii) _____

In winter, snow chains like the ones shown below are attached to the wheels of a car when the roads are icy. This will help the driver to have better control of the car on such road conditions and stay safe.

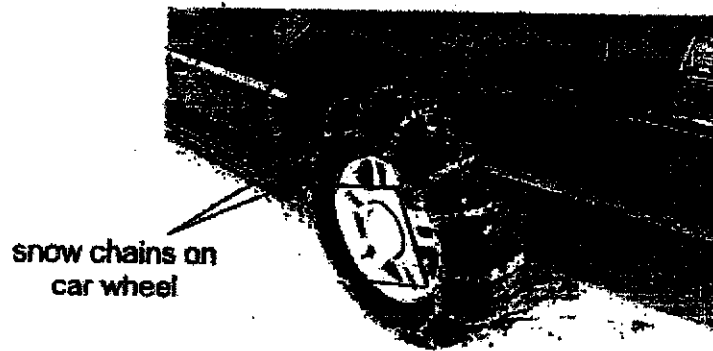

(c) Suggest how the snow chains help the driver to be safe on the icy road. [1]

(Go on to the next page)

SCORE	3
-------	---

- 40 The diagram below shows a circuit breaker which acts as a switch to protect an electric circuit from damage due to a sudden increase in electric current flowing through it.

It is connected to an electric circuit at points X and Y. The iron arm is held by a spring to ensure that the metal contacts are not separated. However, the metal contacts will separate when there is too much electric current flowing through the circuit.

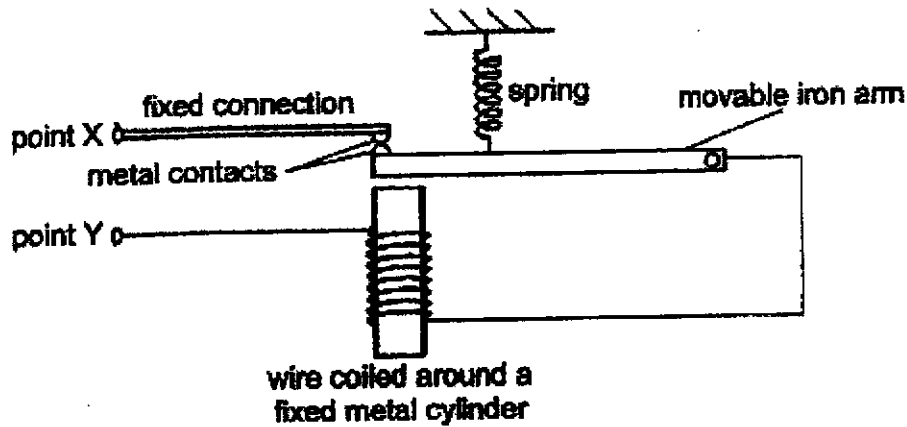

- (a) State a physical property of the iron arm for the circuit breaker to work. [1]

- (b) Explain how the metal contacts separate when there is too much electric current flowing through to prevent damage to the electric circuit. [2]

- (c) Explain why the spring is not able to hold the iron arm when the metal contacts separate. [1]

End of Booklet B

SCORE	4
-------	---

SCHOOL : CATHOLIC HIGH PRIMARY SCHOOL
LEVEL : PRIMARY 6
SUBJECT : SCIENCE
TERM : 2021 PRELIM

CONTACT : CALL

SECTION A

Q 1	Q2	Q3	Q4	Q5	Q6	Q7	Q8	Q9	Q10
4	1	2	1	4	2	4	3	4	3
Q 11	Q12	Q13	Q14	Q15	Q16	Q17	Q18	Q19	Q20
1	2	3	3	2	2	4	3	1	2
Q 21	Q22	Q23	Q24	Q25	Q26	Q27	Q28		
4	1	3	3	1	1	3	4		

SECTION B

Q29)	<p>a)As the number of sit-ups performed increases, the average heart rate per minute increase.</p> <p>b)To allow the heart rate to return to the original amount so this will increase the accuracy of results obtained.</p> <p>c)His breathing rate increased as the pupil needed need more oxygen to be transported to the rest of his body while releasing more carbon dioxide away from his body.</p> <p>d)The pupil ate a banana which is digested function of digested system transportation into simpler substance in the digestive system which would be transported to the body for more energy.</p>
Q30)	<p>a)i)Part Y could still receive water through the water-carrying tubes for photosynthesis.</p> <p>ii)Food produced by Part Y cannot be transported to the roots as there are no food-carrying tubes, causing food to be stuck at part Z.</p>

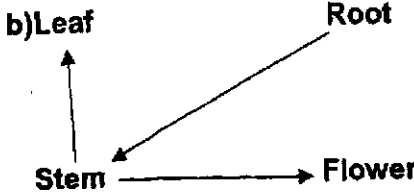
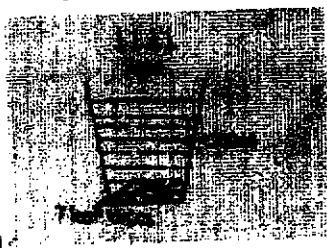
	<p>b) Leaf</p> 
Q31)	<p>a) It increases the chance for the flower to be pollinated and fertilisation for it to produce fruit.</p> <p>b) The seeds would be carried further away from the parent plant and reduces overcrowding and competition over sunlight, water, nutrients and space.</p> <p>c) Fertilisation means the nuclei of a male reproductive cell fuses with the nuclei of a female reproductive cell.</p>
Q32)	<p>a) pod --- ovary bean --- ovule</p> <p>b) Water, Oxygen and suitable temperature.</p> <p>c) The fruit of X has a fibrous husk which traps air so the fruit of X can stay afloat on the water for a longer period of time to be dispersed further away from the parent plant.</p>
Q33)	<p>a) The amount of coloured lights shone.</p> <p>b) Red light increases the rate of photosynthesis in plants faster than Blue light.</p>  <p>c) A cup with 250ml of water with 7 leaf discs in the presence of no coloured light.</p>

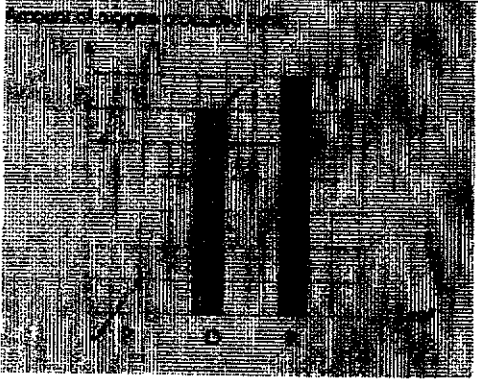
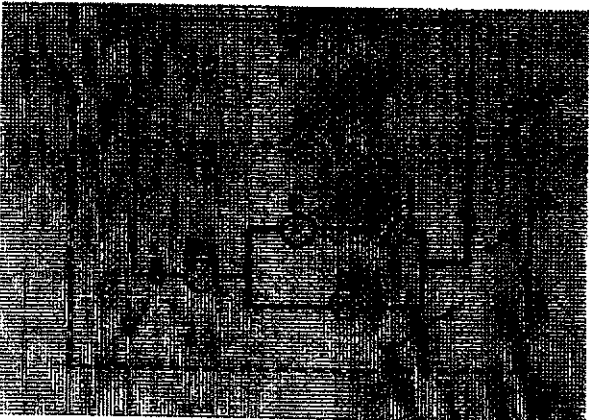
		
<p>Q34)</p>	<p>a) To ensure that the sound level outside the box is due to the material added.</p> <p>b) The same amount of sound will be blocked out.</p> <p>c) S. Material S allows the least amount of sound to be detected outside the box so this will reduce the most amount of sound to be heard outside the house.</p>	
<p>Q35)</p>	<p>a) The warm water vapour from the surroundings lost heat to ice cubes and condensed into tiny water droplets, forming the white mist.</p> <p>b) Substance T increases the rate of ice melting so the ice melts faster compared to ice without substance.</p> <p>c) Sofia should use a beaker that has lesser substance T and another identical with more substance T but the same amount of ice. If the container of ice with substance T melts faster, she can make that conclusion.</p>	
<p>Q36)</p>	<p>a)b)</p> 	

	<p>c)The brightness of B1,B2 and B3 will decrease. The bulbs are in series arrangement so the amount of electric current flowing through each bulb is lesser compared to before.</p>
Q37)	<p>a)Set-up X. There was a greatest surface area of contact. Heat would be lost from the water to the ice faster, hence the temperature of water would drop faster.</p> <p>b)Add cold water into the tub.</p>
Q38)	<p>a)Elastic potential energy in the spring is converted to kinetic energy of the ball when released which converts to gravitational potential energy when it moved higher and converts back into kinetic energy when the ball roll down eventually hit the bell.</p> <p>b)use a stiffer spring. A stiffer spring would have more elastic potential energy which is converted to more kinetic energy of the ball, causing it to hit the bell at position R.</p>
Q39)	<p>a)D. The ball took the longest time to travel the least distance. The frictional force between the ball and the surface was greatest .</p> <p>b)i)The mass of the ball.</p> <p>ii)The diameter of the ball.</p> <p>c)The snow chairs increases the amount of frictional force between the snow chairs on the car wheel and the icy road.</p>
Q40)	<p>a)It is magnetic.</p> <p>b)When there is too much electric current, the wire coiled around a fixed metal cylinder will be a stronger electromagnet temporary magnet. It will attract the movable iron arm and separate the metal contacts.</p> <p>c)The magnetic force of attraction between the metal cylinder and iron arm is greater than the elastic spring force exerted on the iron rod.</p>