



**NAN HUA PRIMARY SCHOOL
CONTINUAL ASSESSMENT 1 2011
PRIMARY SIX
SCIENCE**

Name : _____ ()

Class : Primary 6 / _____

Date : 2 March 2011

Duration : 1 hr 45 min

MARKS	
Sect A:	/ 60
Sect B:	/ 40
Total :	/ 100

Parent's Signature : _____

Section A: (30 x 2marks = 60marks)

For each question from 1 to 30, four options are given. One of them is the correct answer. Make your choice (1, 2, 3 or 4). Shade the correct oval (1, 2, 3 or 4) on the Optical Answer Sheet.

- Which one of the following statements about the Sun is correct?
 - All living things and non-living things on Earth depend only on the Sun to provide them with energy to function.
 - Light energy from the Sun is required for the water cycle to take place on Earth.
 - The light and heat energy from the Sun is used by the plants to carry out photosynthesis.
 - The Sun provides heat energy to keep the surface temperature of the Earth warm enough to support life.
- The following table shows the different forms of energy and its source. Which one of the following is incorrect?

	Form of Energy	Source of Energy
(1)	Gravitational Potential Energy	Water stored behind dams
(2)	Chemical Potential Energy	Vegetables
(3)	Electrical Energy	Dry Cells
(4)	Kinetic Energy	Wind

3. Kai Xin rides her bicycle up a hill. She applies the brakes to stop her bicycle along the hill slope. The kinetic energy of the moving bicycle is changed into _____ when the bicycle comes to a stop completely.

- A Heat Energy
- B Sound Energy
- C Chemical Potential Energy
- D Gravitational Potential Energy

- (1) A and B only
- (2) A and C only
- (3) A, B and C only
- (4) A, B and D only

4. Which of the following are examples of a pushing force only?

- A Sawing a wooden plank
- B A car crashing into a tree
- C Dragging a bag along the floor
- D Inserting a coin into vending machine

- (1) A and B only
- (2) A and D only
- (3) B and D only
- (4) C and D only

5. The diagram below shows a metal ball hanging from a string. Which one of the following statements about the diagram is true?

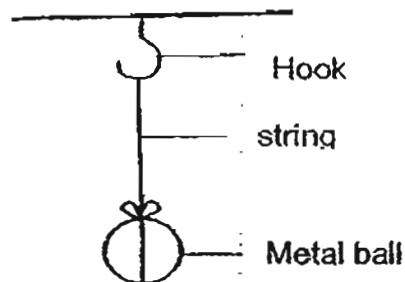

Floor

- (1) There is no gravity acting on the ball so it does not fall.
- (2) There is friction pushing the ball upwards so it does not fall.
- (3) There is gravity acting on the ball so the ball hangs downwards.
- (4) There is magnetic force of attraction between the ball and the hook so it stays in the air.

6. Which one of the following graphs correctly represents the relationship between the load and the extension of a spring?

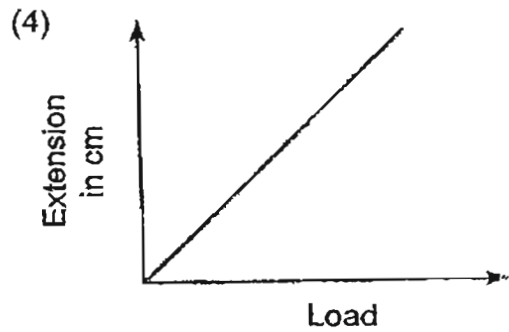
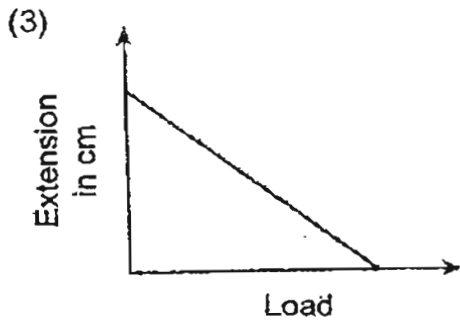
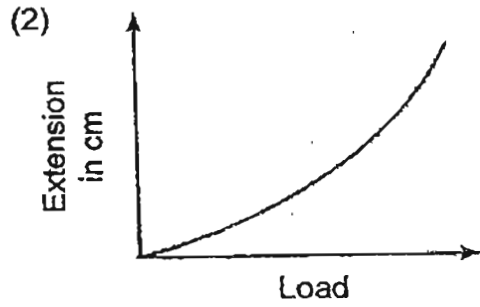
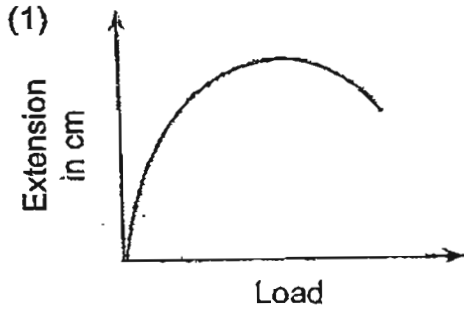

7. A, B, C and D are processes occurring in the sexual reproduction of flowering plants.

- A Seed Dispersal
- B Fertilisation
- C Seed Germination
- D Pollination

Which of the following shows the correct order of the processes in the sexual reproduction of flowering plants?

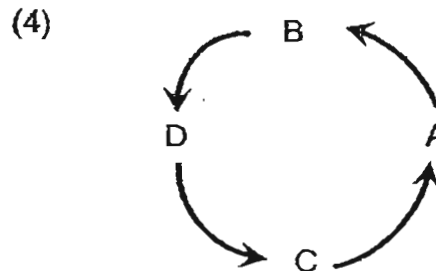
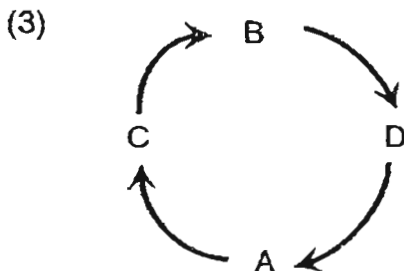
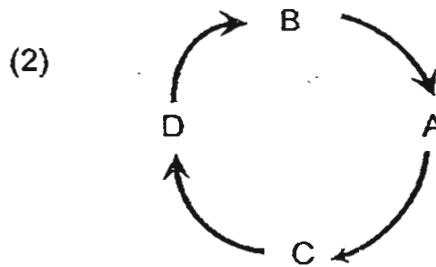
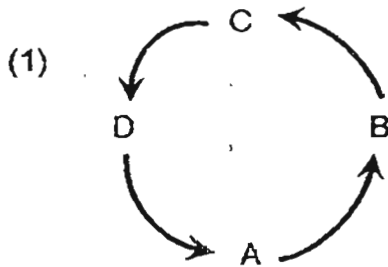

8. Study the diagram below carefully.

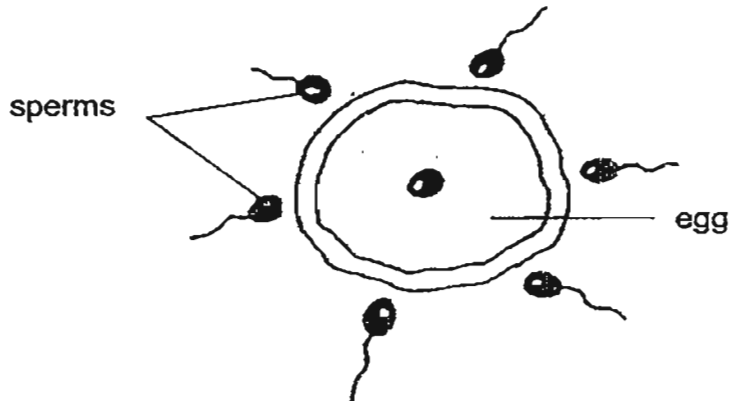

Which of the following statements about reproduction in animals are incorrect?

- A Sperms are produced by male animals.
- B Usually one egg is fertilized by many sperms.
- C After fertilization, the egg will grow and develop into a young.
- D Fertilisation always takes place while the egg is still inside the body of the female animal

- (1) A and D only
- (2) B and C only
- (3) A and C only
- (4) B and D only

9. Which of the following parts are present in both a plant and animal cell?

- (1) cell wall, cell membrane and nucleus
- (2) cell membrane, nucleus and cytoplasm
- (3) cell wall, nucleus, chloroplast and cytoplasm
- (4) cell wall, cell membrane, chloroplast and cytoplasm

10. Which one of the following diagrams shows a closed circuit?

(1)

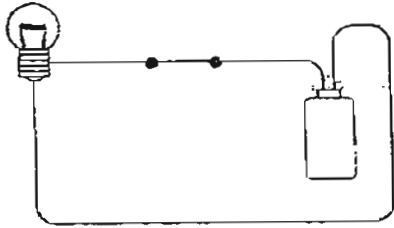

(2)

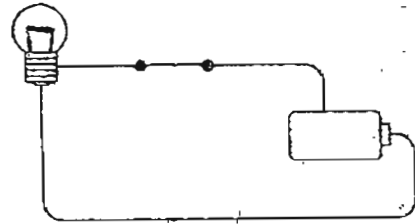

(3)

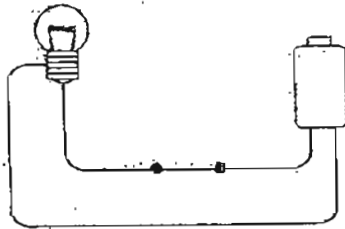

(4)

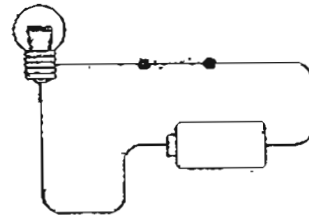

11. The diagram below shows the Sun and some organisms interacting with their environment.

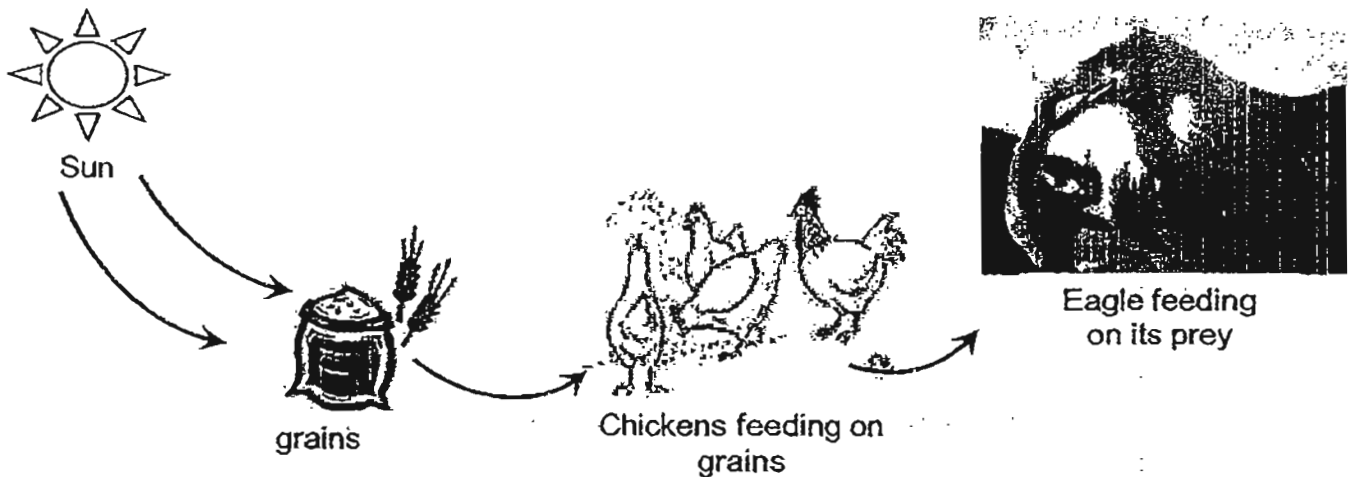

The diagram above shows _____

- (1) how the organisms move in the environment to look for food
- (2) the gaseous exchange between organisms in the environment
- (3) that the food produced by plants becomes a source of energy for animals
- (4) that plants and animals rely directly but not indirectly on the Sun as a primary source of energy

12. Four pupils were discussing among themselves while making comparisons on the following organisms.

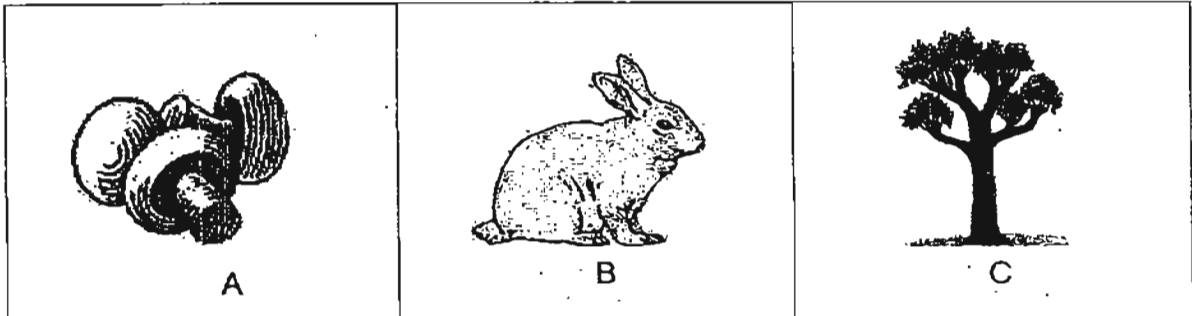

The pupils made the following statements:

- Jeff : "All the above organisms need food to grow."
Lily : "A and C contain chlorophyll while B does not."
Carol: "B can move on its own to find food but not A and C."
Dawn: "C depends on the Sun to make food while B and A does not."

Which of the above pupil(s) had made the correct statement(s)?

- (1) Jeff only
- (2) Jeff and Dawn
- (3) Jeff, Lily and Dawn
- (4) Jeff, Carol and Dawn

13. Study the flowchart below.

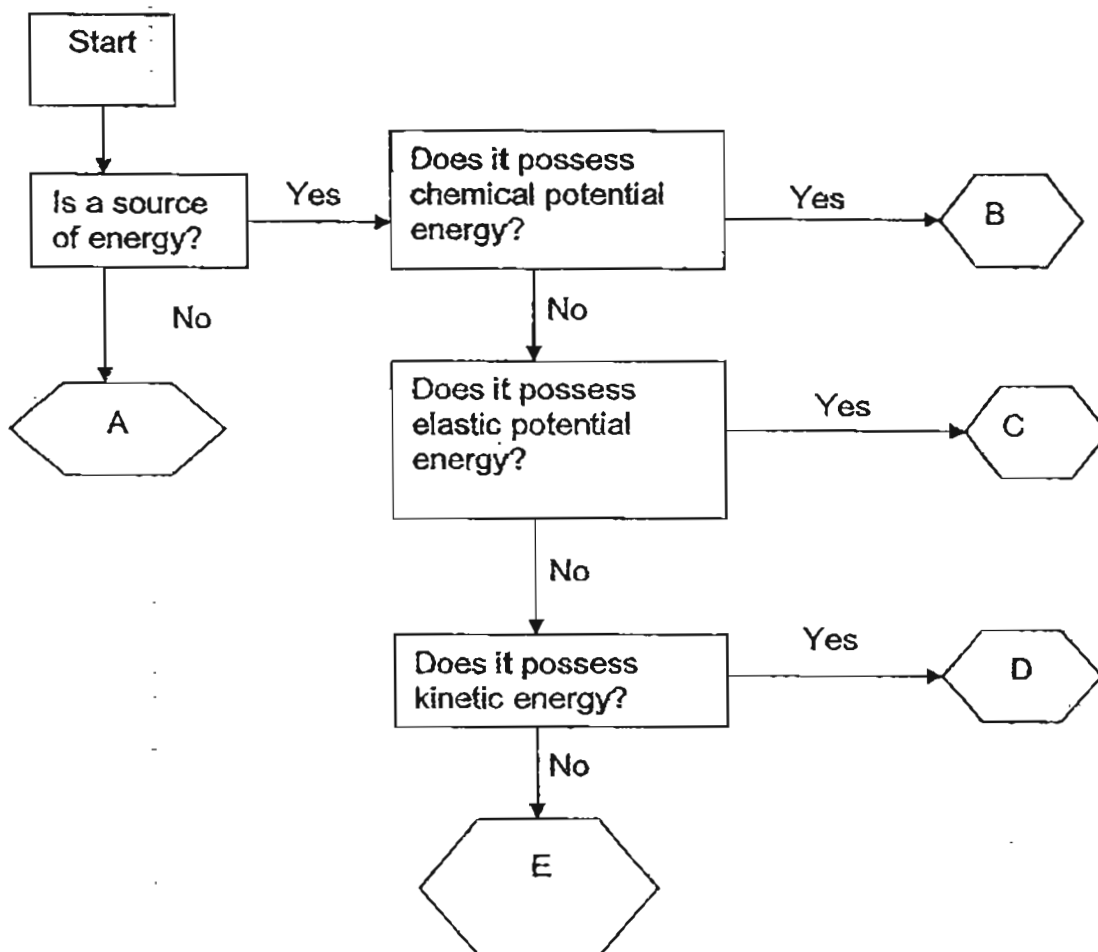

Which of the following best describes A, B, C, D and E?

	A	B	C	D	E
(1)	Mass	food	unstretched rubber band	wind	stationary car
(2)	Shadow	dry cell	compressed spring	running water	light bulb
(3)	Vacuum	petrol	wound-up toy	painting hung on the wall	siren
(4)	Weight	natural gas	Sun	falling apple	candle

14. Thomas dropped a ball from a height at Point A. It landed at Point B and rebounded to the height at Point C as shown in the diagram below.

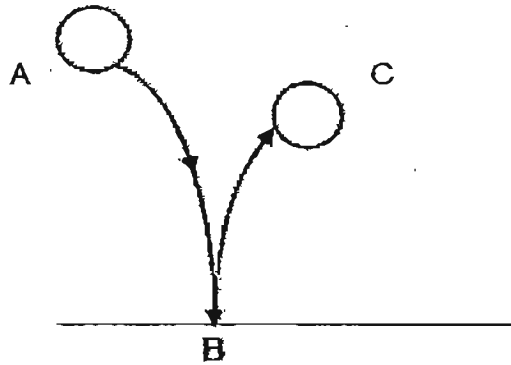

Which one of the following shows the correct energy conversion from Point A to Point B and then to Point C?

- (1) Kinetic Energy → Heat Energy + Sound Energy → Gravitational Potential Energy
- (2) Gravitational Potential Energy → Kinetic Energy → Heat Energy + Sound Energy
- (3) Gravitational Potential Energy → Kinetic Energy → Heat Energy + Sound Energy → Gravitational Potential Energy
- (4) Gravitational Potential Energy → Kinetic Energy → Sound Energy → Elastic Potential Energy

15. 2 similar balls, A and B, of mass 10 kg and 4 kg respectively, are moving at the same speed in the direction indicated by the arrows as shown in the diagram below.



Which one of the following is most likely to happen?

- (1) Ball A stops moving after the collision.
- (2) Ball A continues to move in the same direction.
- (3) Ball A moves at a greater speed in the opposite direction.
- (4) Ball A moves with the same speed in the opposite direction.

16. Ravi set up an experiment as shown below. When she released the toy car from the top of the plank, it reached Point X in 15 seconds.

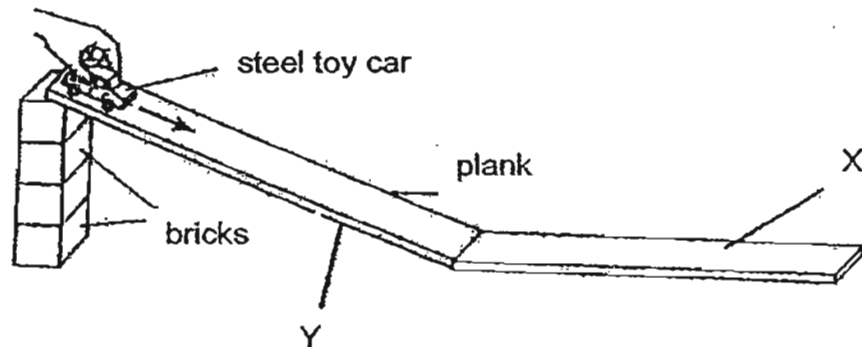

What should Ravi do if she wanted the toy car to reach Point X in 10 seconds?

- A Increase the number of bricks.
- B Sprinkle powder on the plank.
- C Exert more force when ~~he~~^{she} released the car.
- D Attach a magnet on the underside of the plank at Y.

- (1) A and D only
- (2) A, B and C only
- (3) B, C and D only
- (4) A, B, C and D

17. When Rick jumped off from the plank, Force A was exerted on him. When he lands on the trampoline, another force, Force B, was exerted on him.

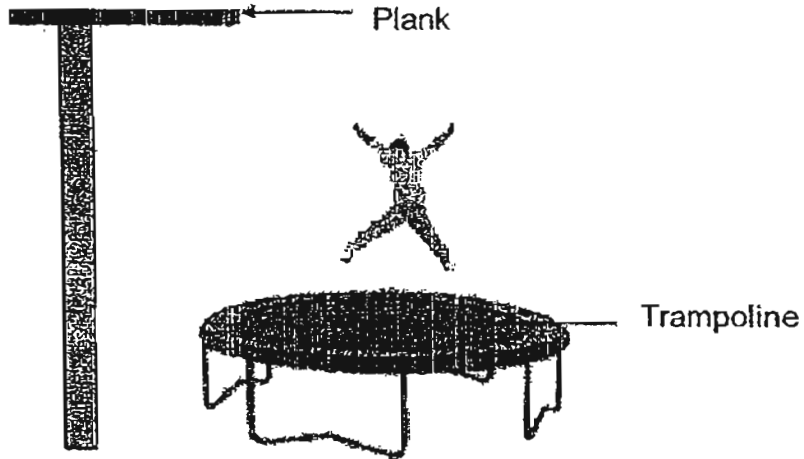

Which one of the following represents correctly Force A and Force B and their directions respectively?

	Force A	Direction of Force A exerted on Rick	Force B	Direction of Force B exerted by the trampoline
(1)	Gravitational Force	Downwards	Elastic Spring Force	Upwards
(2)	Elastic Spring Force	Downwards	Gravitational Force	Downwards
(3)	Gravitational Force	Downwards	Elastic Spring Force	Downwards
(4)	Elastic Spring Force	Upwards	Gravitational Force	Downwards

18. The diagrams below show the same spring holding different amount of weights, A, B, C and D, respectively.

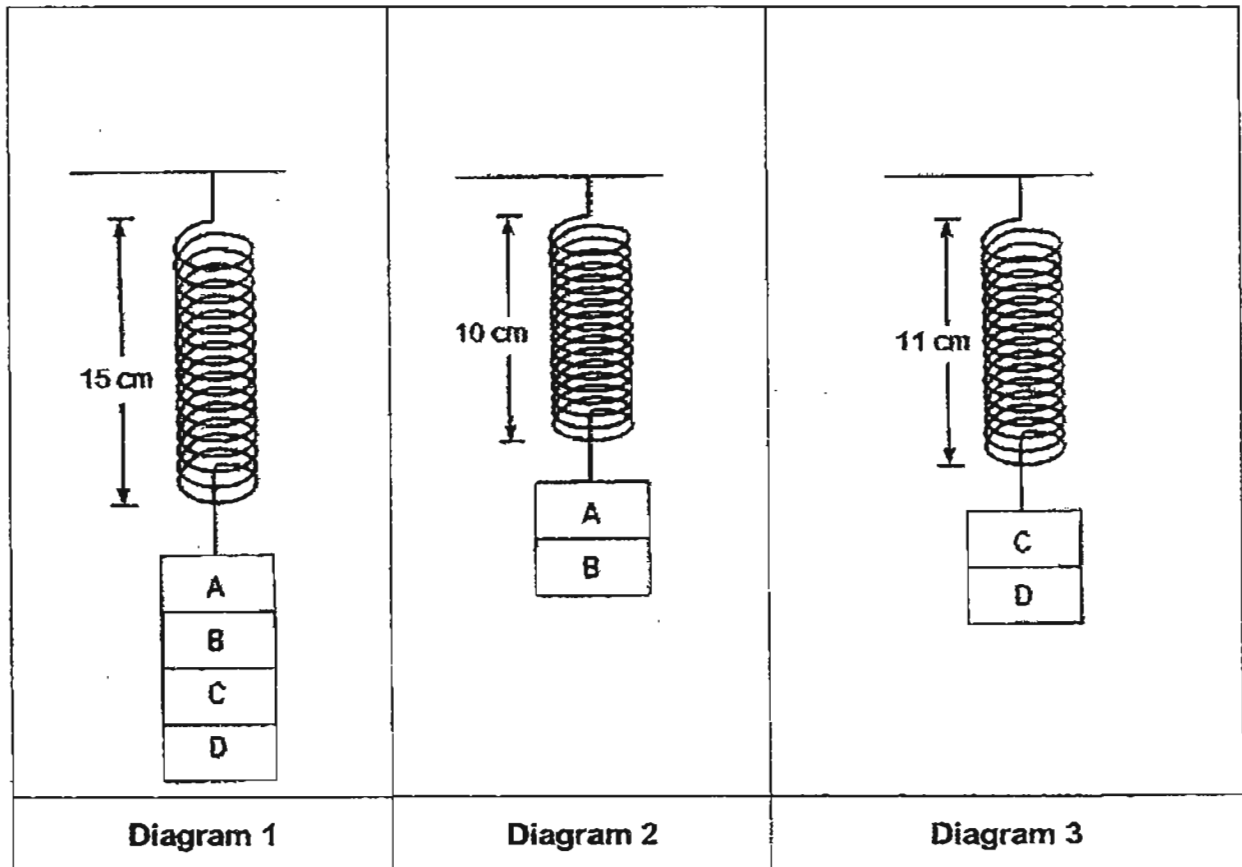

Based on the results shown in the diagram, what is the original length of the spring?

- (1) 7 cm
- (2) 6 cm
- (3) 5 cm
- (4) 4 cm

19. The same amount of force was exerted on a 500g object. The diagrams below show the distance moved by the object on Surface A, B, C and D respectively before coming to a stop.

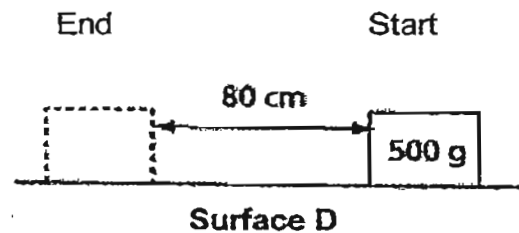
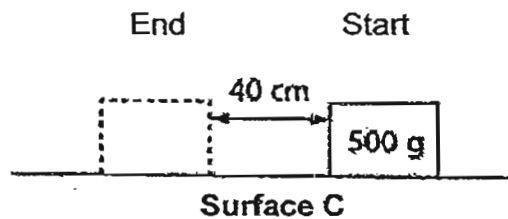
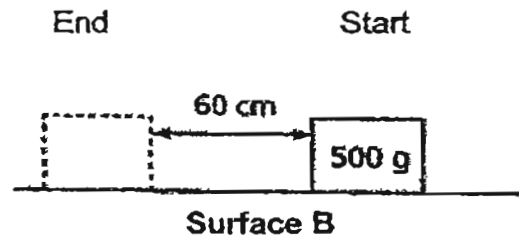
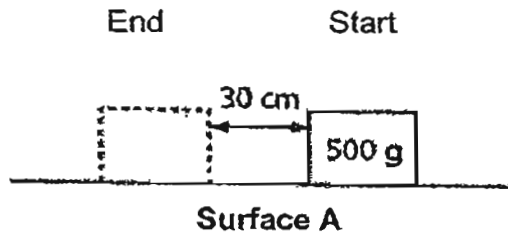

Arrange the four surfaces, A, B, C and D in descending order of the frictional forces between the object and the surfaces, starting with the largest amount of frictional force.

- (1) A, B, C, D
- (2) A, C, B, D
- (3) B, A, D, C
- (4) D, B, C, A

20. The diagram below shows the water cycle.

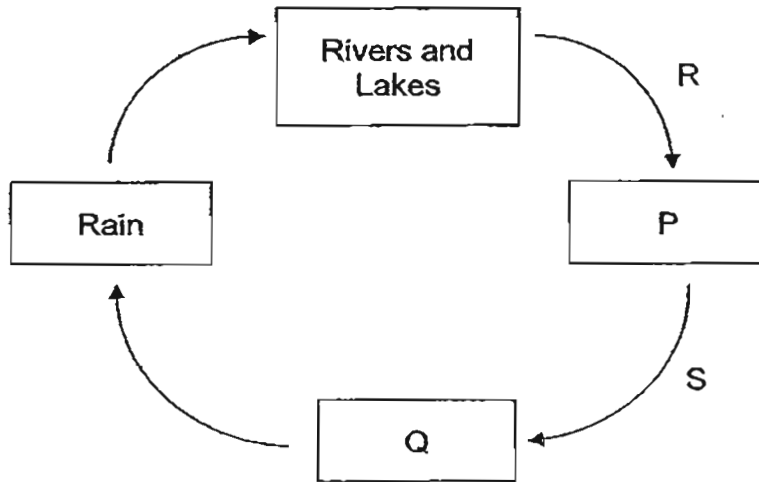

Which one of the following best represents P, Q, R and S respectively?

	P	Q	R	S
(1)	clouds	water vapour	lose heat	gain heat
(2)	water vapour	clouds	lose heat	gain heat
(3)	water vapour	clouds	gain heat	lose heat
(4)	clouds	water	gain heat	lose heat

21. The diagrams below show the reproductive parts of a plant and a human.

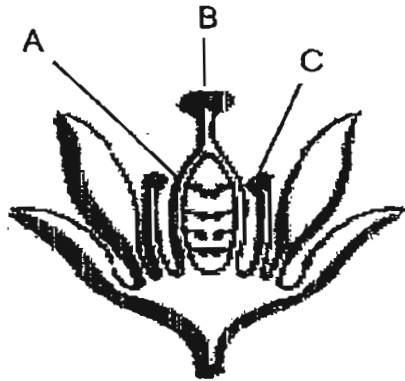

Plant reproductive system

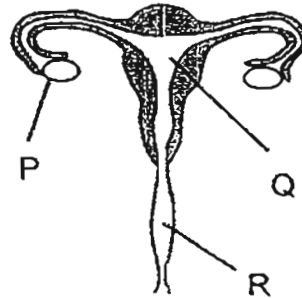

Human reproductive system

Which one of the following reproductive parts of a plant and a human perform a similar function?

	Plant Reproductive System	Human Reproductive System
(1)	A	P
(2)	A	R
(3)	B	Q
(4)	C	Q

22. Sherry removed an outer ring of the stem between positions X and Y of a plant as shown in the diagram below.

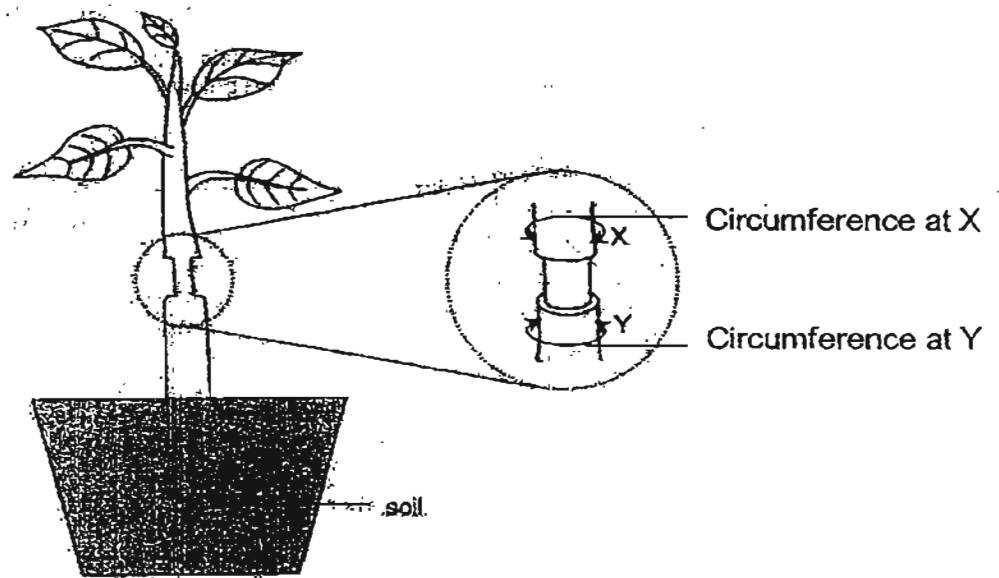

Note: Circumference refers to the distance round the stem

The table below records the circumference of the stem at Part X and Y at the start and at the end of the experiment after a few days.

	Circumference of stem at...	
	X	Y
At the start	15mm	15mm
At the end	18mm	15mm

Based on the results, which one of the following conclusion is most likely to be correct?

- (1) Both the water and food-carrying tubes were removed.
- (2) Both the water and food-carrying tubes were not removed.
- (3) Only the food-carrying tubes were removed but not the water-carrying tubes.
- (4) Only the water-carrying tubes were removed but not the food-carrying tubes.

23. The table below shows a circuit and what happens when the three rods, X, Y and Z are placed, one at a time, across AB in the circuit.

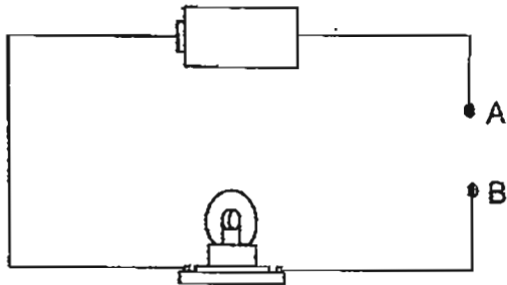

Rod placed across A and B	Bulb lights up
X	✓
Y	x
Z	✓

In another experiment, the same amount of wax was placed on the top end of the same three rods X, Y and Z. They were then placed into a container of hot water as shown in the diagram below.

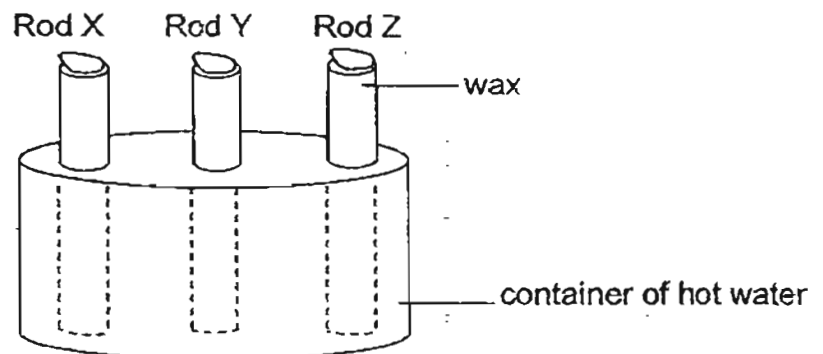

The time taken for the wax to melt on each rod is recorded in the table below.

Rods	Time taken to melt (s)
X	77
Y	160
Z	52

Which of the following can be inferred from the experiment?

- (1) Rod X is the best conductor of heat.
- (2) Rods X, Y and Z are made of metal.
- (3) Rod Y is an electrical insulator but a good conductor of heat
- (4) Rods X and Z are conductors of electricity and good conductors of heat.

24. Sally has 3 sheets made of different materials as shown below.

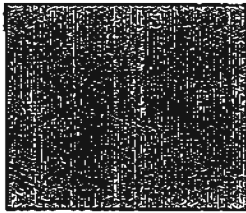

Frosted glass

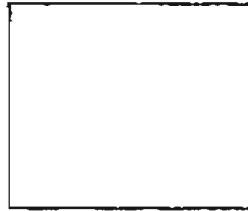

Clear glass

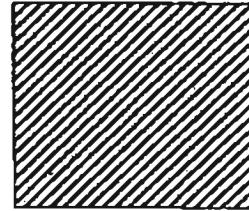

Metal

She first placed the frosted glass between a lamp and a light sensor connected to a datalogger and recorded the amount of light detected. She then repeated the same process by attaching a clear glass to the frosted glass and then finally, with all 3 sheets, frosted glass, clear glass and metal, attached together as shown below.

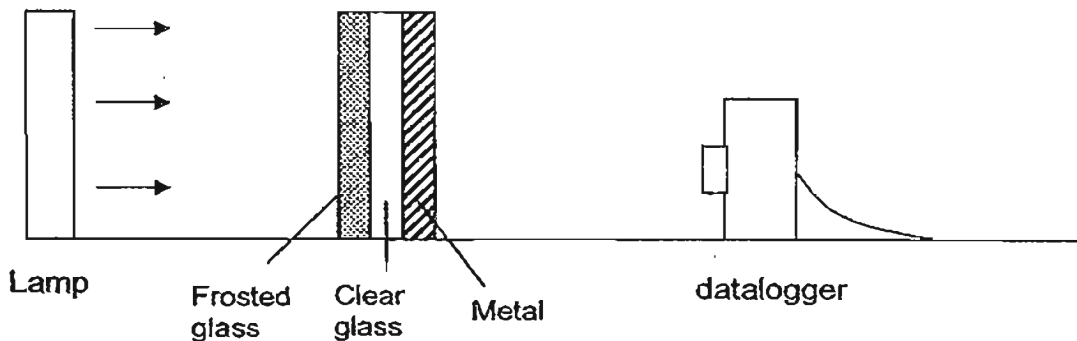

Which one of the following most likely represents the results of her experiment?

	Amount of light recorded (lux)		
	Frosted glass only	Frosted glass and Clear glass attached	Frosted glass, Clear glass and Metal attached
(1)	400	200	0
(2)	100	0	500
(3)	200	500	100
(4)	400	400	0

25. Mary filled two identical cups, A and B, with hot water and cold water respectively. She then placed an identical steel sheet over each cup and left them in the same room.

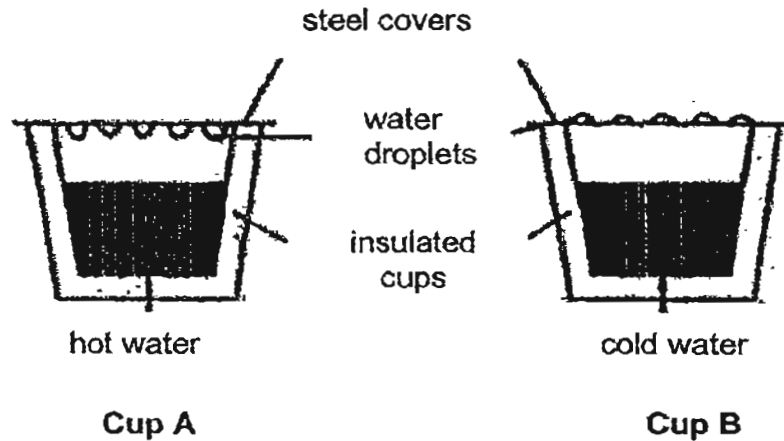

She observed the two cups after 5 minutes and drew the following conclusion:

- A The hot water vapour in Cup A condensed on the hotter under surface of the steel cover.
- B The water vapour in the surrounding air condensed on the cooler top surface of the steel cover placed over Cup B.
- C The insulated cups, A and B, reduced heat loss and heat gain from the surroundings respectively.
- D The water vapour in the surrounding air does not condense on the top surface of steel cover in Cup A as the water vapour in the surrounding air is cooler than the surface of the steel cover.

Which of the above statements are correct?

- (1) A and C only
- (2) B and D only
- (3) A, B and C only
- (4) B, C and D only

26. Jane observed two animals and recorded her observations in the table below.

Observation	Animal X	Animal Y
It has six legs.		✓
Eggs are laid in water.	✓	
There are four stages in its life cycle.		

What can Animal X and Y be?

	Animal X	Animal Y
(1)	Toad	Spider
(2)	Guppy	Dragonfly
(3)	Chicken	Housefly
(4)	Frog	Grasshopper

27. Jerry placed three similar bottles which contained substances, X, Y and Z, on a shelf as shown in the diagram below.

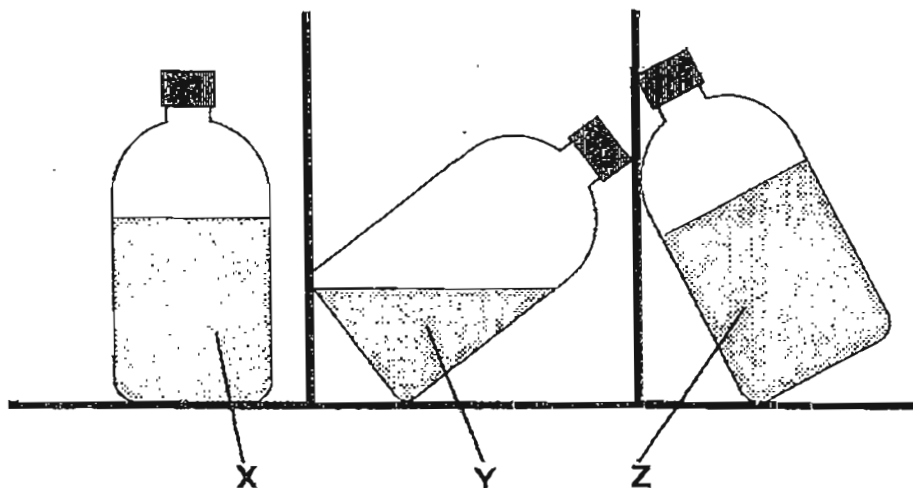

Based on the diagram above, which of the following statements are **definitely** true?

- A Substance Y is a liquid.
 - B Substance Z is a solid.
 - C All three substances have definite shapes.
 - D All three substances have definite volumes.
- (1) A and B only (2) B and C only
(3) B and D only (4) A, B and D only

29. The classification chart below shows some characteristics of Animals A, B, C, D and E.

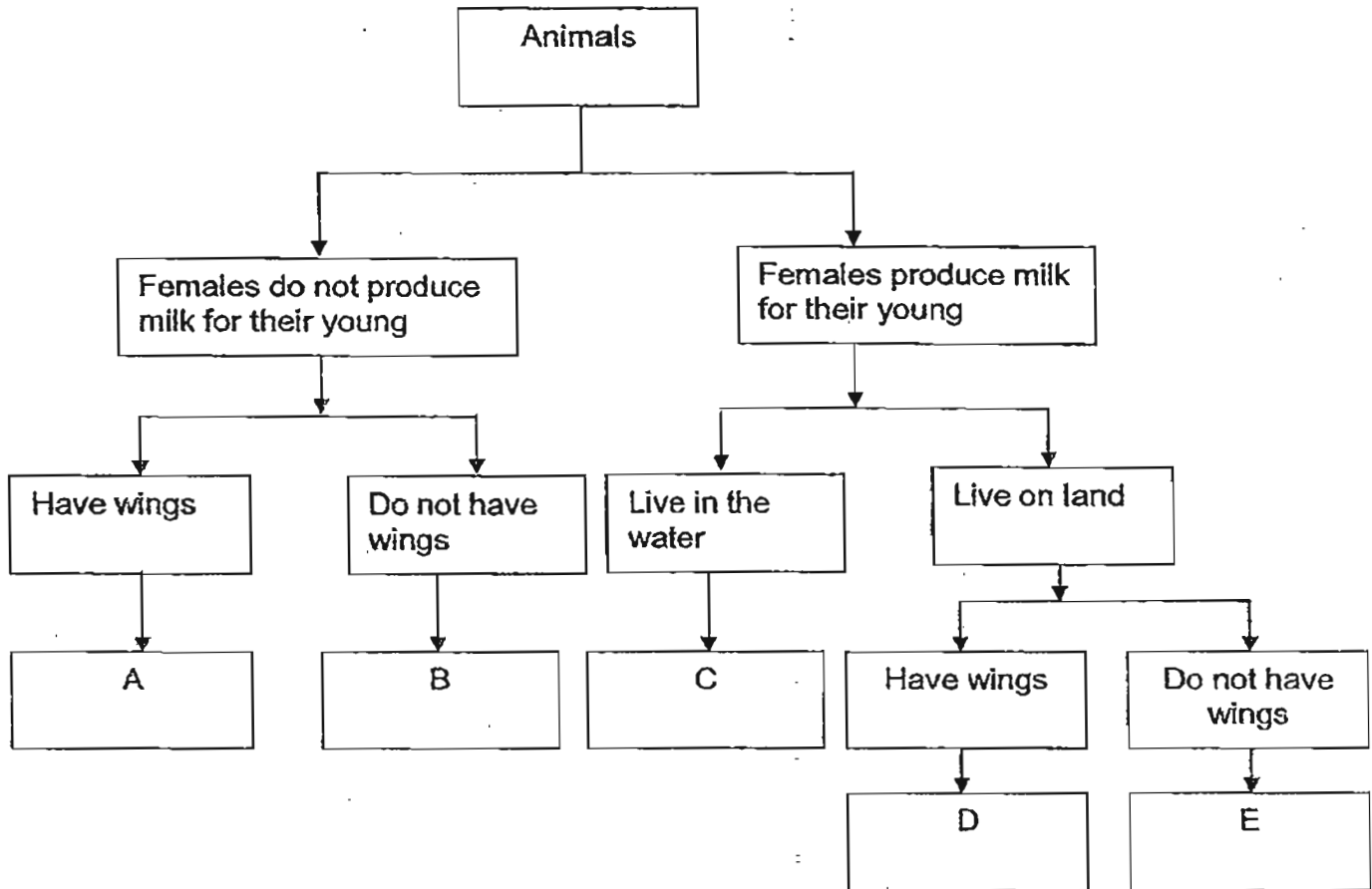

Which one of the following statements is true?

- (1) A, B, D and E can swim.
- (2) A and D are flying insects.
- (3) C, D and E are mammals.
- (4) D is a bird that lives on land.

30. Study the flow chart as shown below.

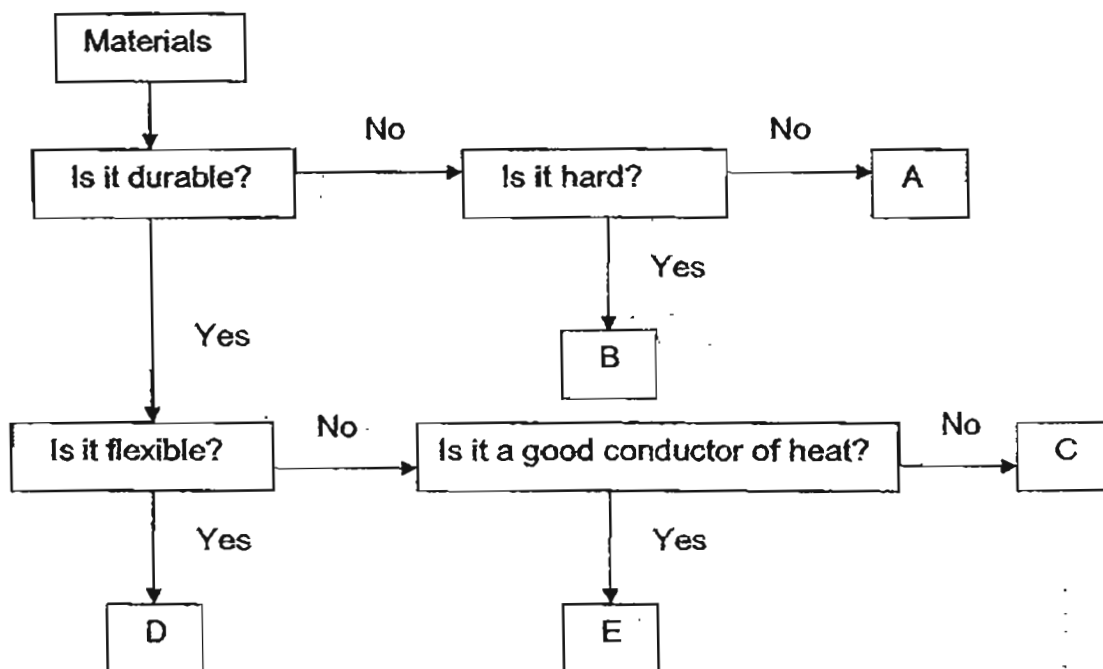

Which materials, A to E, have properties that allow them to be made into a porcelain vase, a newspaper and a frying pan?

	Porcelain Vase	Newspaper	Frying Pan
(1)	C	B	E
(2)	C	A	E
(3)	D	B	C
(4)	D	A	C



**NAN HUA PRIMARY SCHOOL
CONTINUAL ASSESSMENT 1 2011
PRIMARY SIX
SCIENCE**

Name : _____ ()

Class : Primary 6 / _____

Date : 2 March 2011

MARKS	
Sect B:	/ 40
Total :	/ 100

Section B: (40marks)

Write your answers to question 31 to 44.

The number of marks available is shown in brackets [] at the end of each question or part question.

31. We obtain the various forms of energy from the different sources of energy. Study the classification chart as shown below and fill in the boxes with the correct answer. [3]

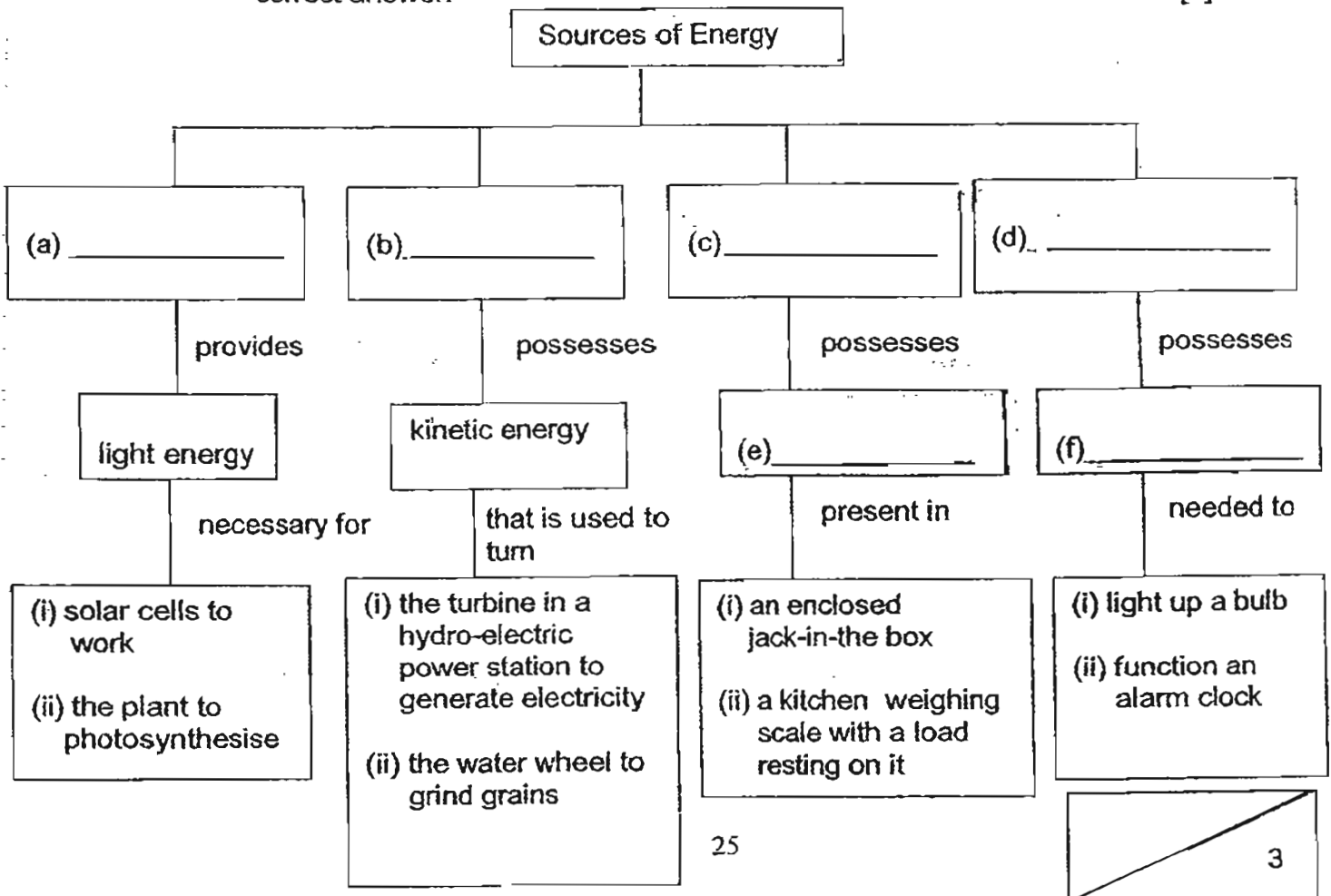

32. The diagram below shows a flower pot dropping from a 7th storey window.

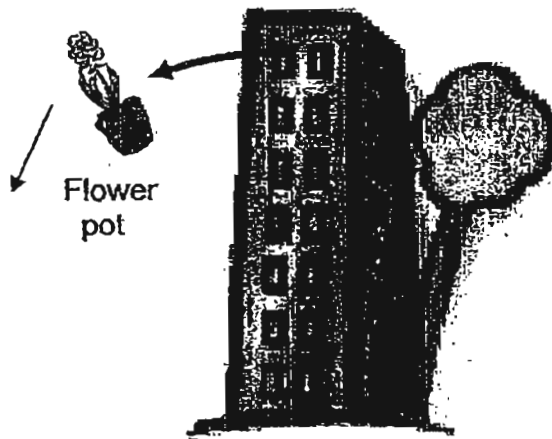

The graph below shows the relationship between the speed of a falling flower pot and the kinetic energy that it possesses.

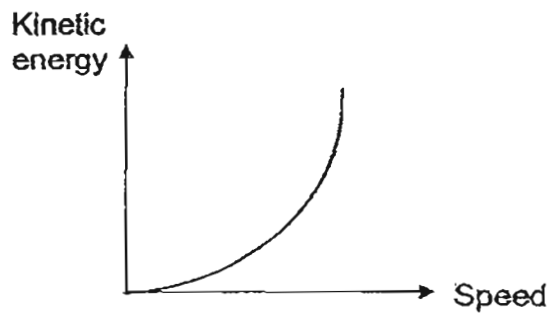

(a) Based on the graph, what can you infer about the relationship between the speed and the kinetic energy of the falling flower pot? [1 m]

(b) Fill in the boxes to show the energy changes when the flower pot fell and hit onto the ground. [1m]

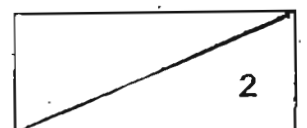
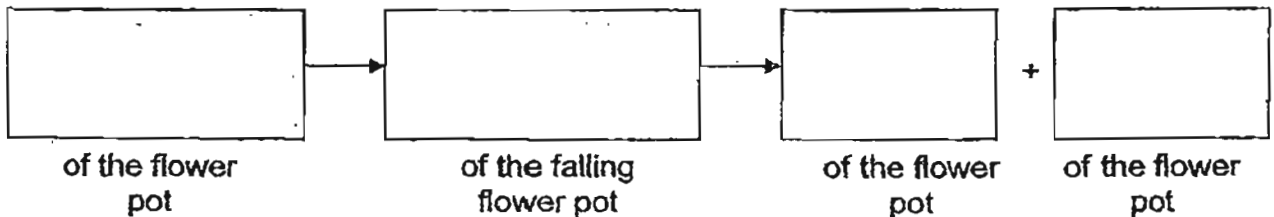

- (c) Describe clearly how you would find out if the mass of a ball would affect the gravitational potential energy it possesses. [2m]

33. James hit a tennis ball using his racket. The diagram shows the path of motion of the tennis ball after he hit it.

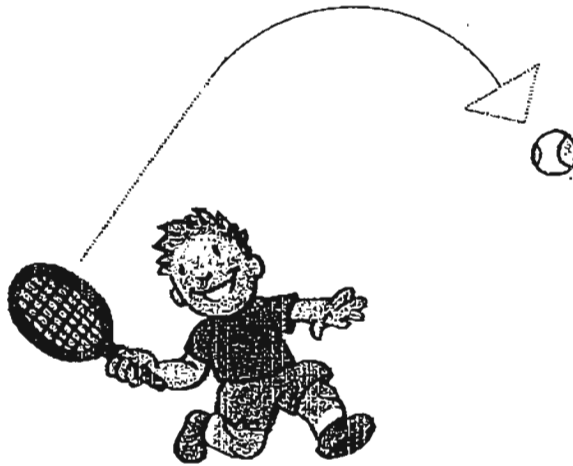

- (a) Besides the force applied by James, name another force that is acting on the tennis ball. [1m]

- (b) How can you tell, based on the path of motion of the tennis ball, that the force stated in (a) is acting on the tennis ball? [1m]

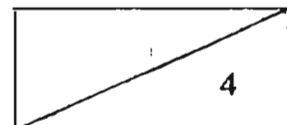

34. The following diagrams show four activities, A, B, C and D.

A:

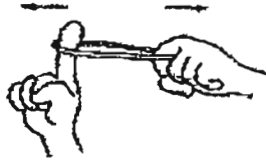

B:

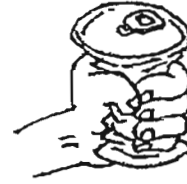

C:



D:



(a) Write the letters 'A', 'B', 'C' and 'D' correctly in the classification table below. [1m]

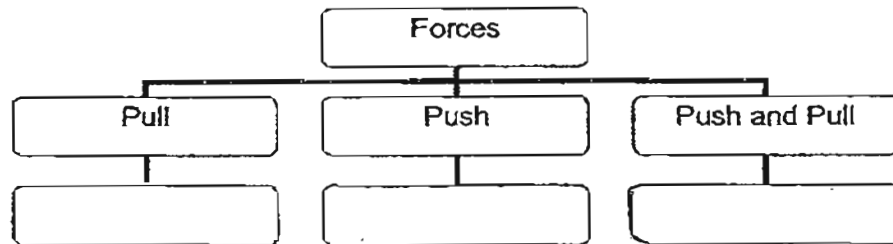

(b) In Activity D, the boys holding onto the rope are able to grip it. Explain why this is so. [1m]

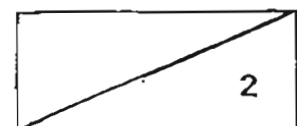

35. Sam carried out an experiment to find out if the position of the light affects the length of the shadow formed. He positioned his torch at an angle, W , as shown in the diagram below. He shone it at a stick and measured the length of the shadow formed.

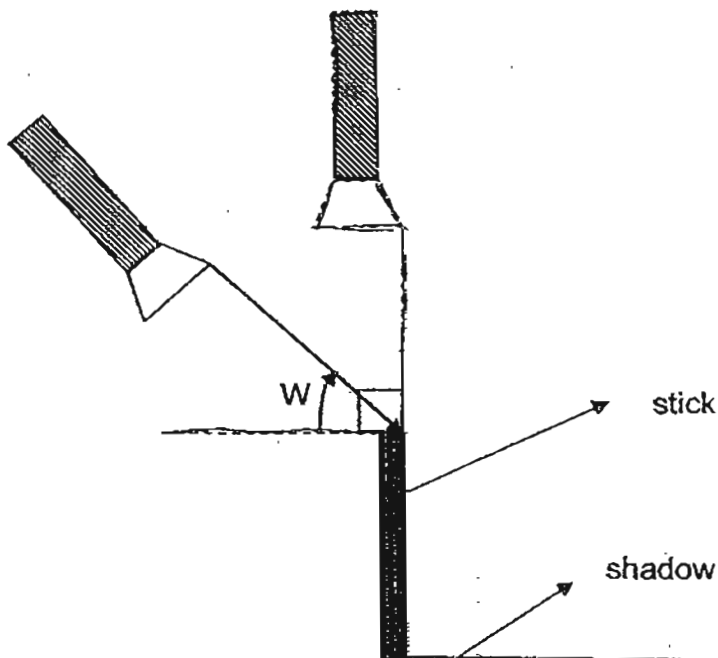

He repeated the experiment, increasing the size of the angle, W , each time as shown in the table below. Then, he recorded his observation.

Size of the angle, W ($^{\circ}$)	Length of shadow (cm)
50	10
60	8
70	6
80	4
90	?
100	4
110	6
120	8

- (a) Based on the results in the table above, estimate the length of the shadow when the angle, W , is at 90° [1m]

- (b) From his observation, what can he conclude about the relationship between the angle, W , and the length of the shadow formed? [2m]

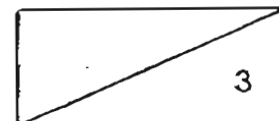

36. John wanted to find out how the coloured lights affect the rate of photosynthesis. He placed 4 identical set-ups within similar clear plastic boxes as shown in the diagram below. 3 of the set-ups were wrapped in red, yellow, and blue cellophane paper round the plastic box respectively.



standing lamp

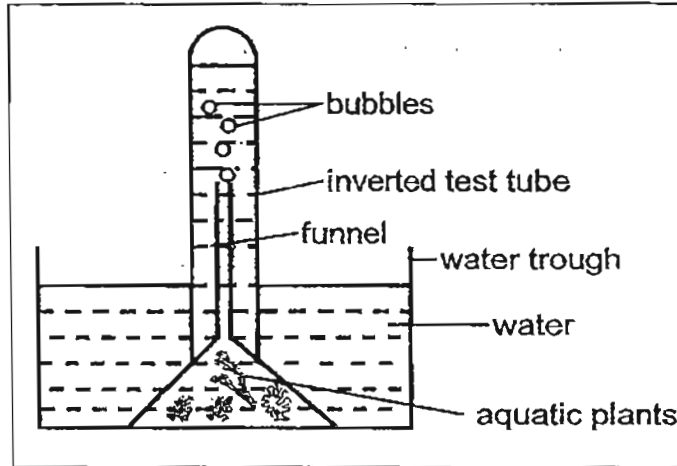

clear plastic box

The 4 set-ups were placed in 4 identical dark rooms with identical lamp with white light shining at it from the same distance for 3 hours. The number of bubbles produced in the respective set-ups were observed and recorded in the table below.

Set- up wrapped with cellophane paper coloured ...	Number of bubbles formed...
Red	47
Yellow	13
Blue	60
Set up without cellophane paper	26

- (a) (i) Name the independent variable (variable that has to be changed) in this experiment. [1m]

- (ii) What do the bubbles contain? [1m]

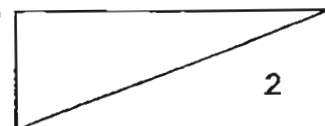

- (b) Based on the result table, which light condition has the best effect on the rate of photosynthesis? Give a reason for your answer. [1m]

37. Andy conducted an experiment to find out if the type of material used to make the rod affects the number of paper clips attracted to it when placed in a closed circuit. He set up the experiment as shown below.

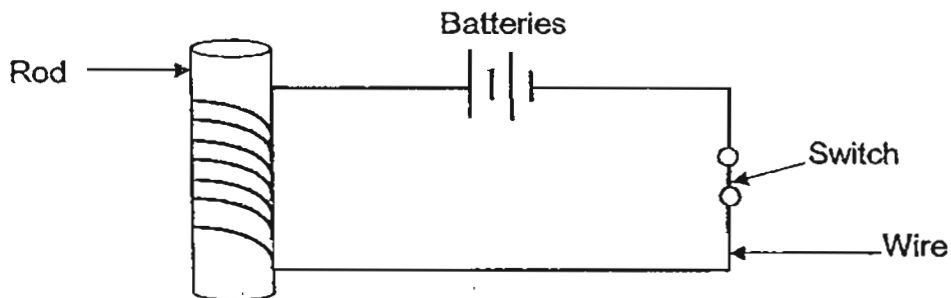

He carried out the experiment with rods made of different materials. He controlled the variables as shown in the table below.

	Constant Variable (thing kept the same)	Independent Variable (thing that changed)
Thickness of the rod		✓
Material of the rod		✓
Number of dry cells	✓	
Number of turns of wire around the rod	✓	

The results were recorded in the table below.

Material of rod	Number of paper clips attracted
W	14
X	0
Y	3
Z	6

- (a) Do you think Andy's experiment was a fair one? Give a reason for your answer. [1m]

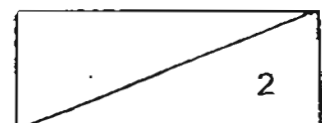

- (b) Andy found out that Material X did not attract any paper clips. Based on this observation, what can you conclude about Material X? [1m]

38. Alice hung two identical paper cups, A and B, on a balanced horizontal rod. A bunsen burner was then placed directly under cup A as shown below.

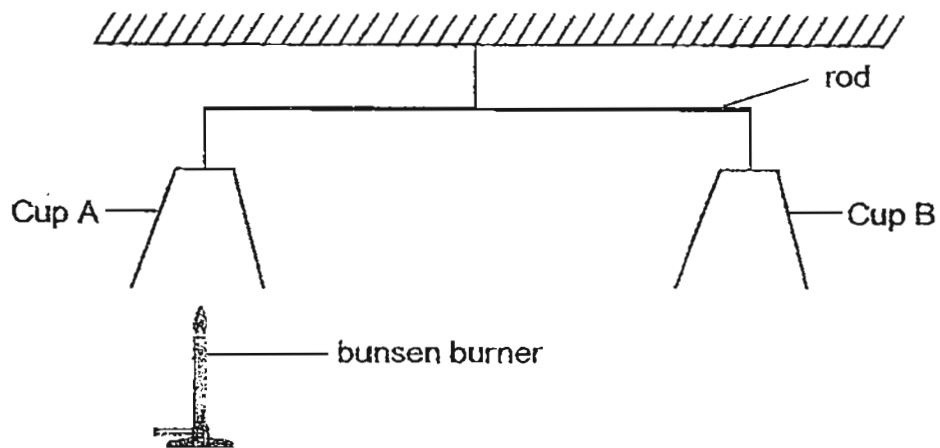

After 10 minutes, Alice observed that the rod tilted towards Cup B.

- (a) Explain what caused Cup A to move upwards. [1m]

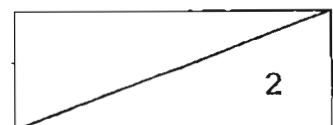

- (b) Alice then hung two similar iron rings, X and Y, on a balanced rod. Ring X was heated as shown in the diagram below.

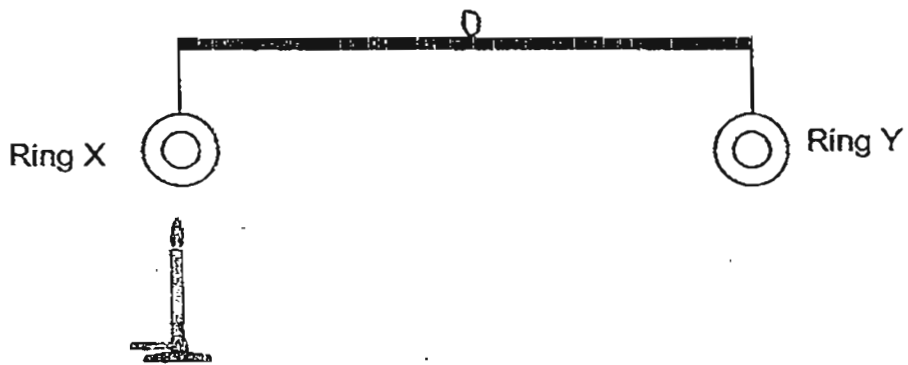

Alice predicted that Ring X will tilt downwards after being heated. Do you agree with her? Give a reason for your answer. [1]

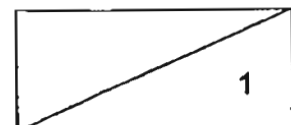

39. Jack made a jumping toy with a folded card. Both ends of the card are fastened with a rubber band as shown in the diagram below.

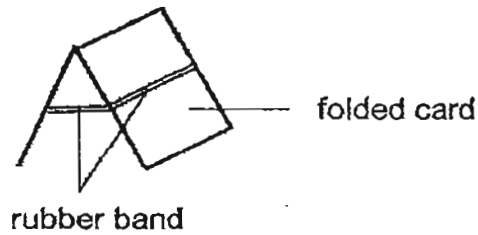

When Jack pressed down the toy and then released, it jumped off the ground.

When the card is not pressed down

When the card is pressed down

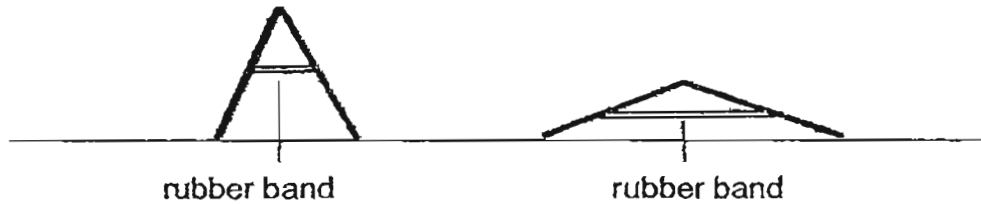

- (a) (i) Explain how the toy is able to jump off the ground when it was being released by Jack. [1m]

- (ii) What could Jack do to make the toy jump higher? [1m]

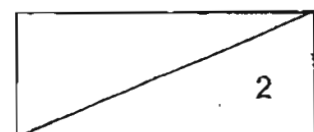

A child was playing on a 'flybar' as shown in the diagram below. A 'flybar' is a device for jumping off the ground in a standing position with the aid of a spring. It consists of a pole with a handle at the top and foot rests near the bottom, and a spring located along the pole.

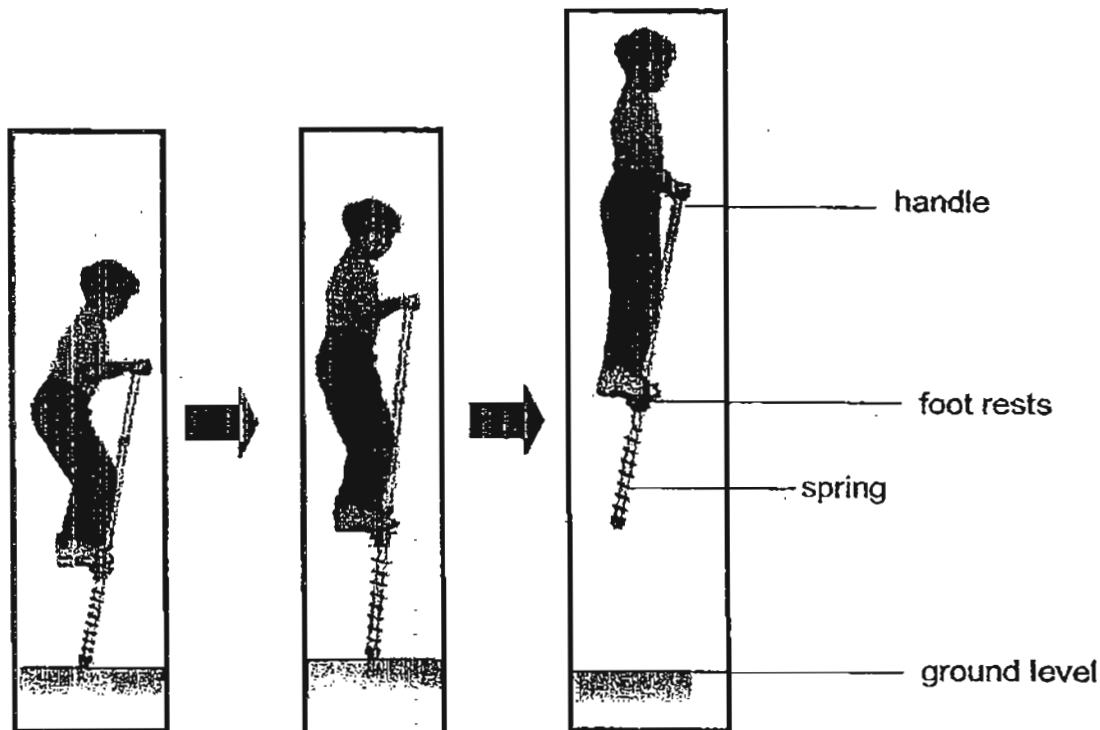

(b) Explain how the child was able to be lifted off the ground. [1m]

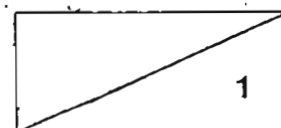

40. Dylan accidentally dropped a steel disc into a thin glass container half-filled with water, as shown in the diagram below.

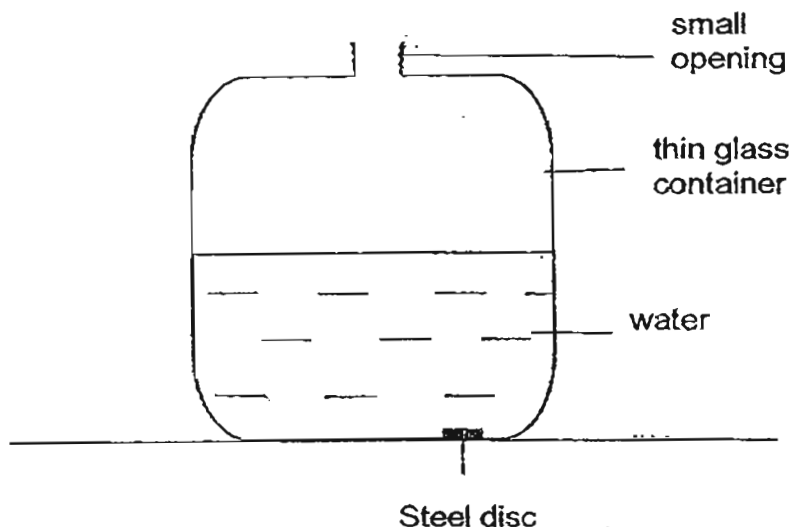

- (a) How could Dylan remove the steel disc using a magnet only without moving the glass container and wetting the magnet? [2m]

- (b) If the steel disc was accidentally dropped into an iron container instead, would Dylan still be able to remove the steel disc using only the magnet as mentioned in part (a)? Give a reason for your answer. [1m]

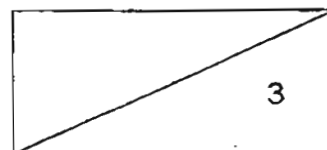

41. Jason conducted an experiment to find out how the different types of lubricants applied on the table surface affect the distance moved by the wooden block.

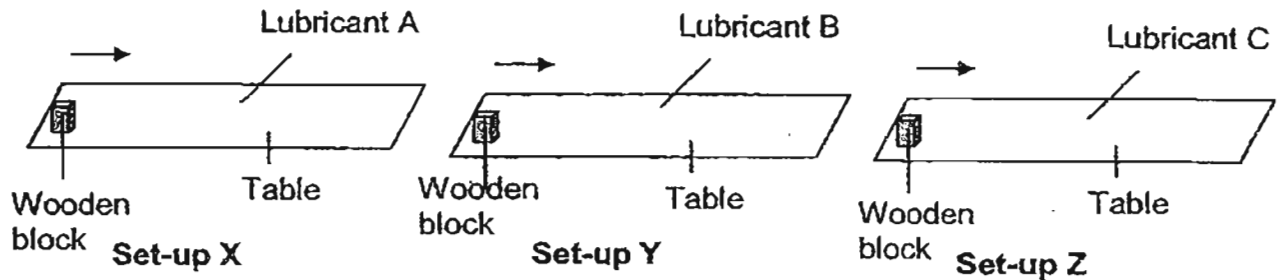

Same amount of the different lubricants, A, B and C, were applied on the surfaces of 3 identical tables in Set-ups X, Y and Z respectively.

Same amount of force was applied to the wooden blocks in the direction indicated by the arrow in the diagram above. The distance moved by the wooden blocks was recorded in the table below.

Type of lubricants	Distance moved by the wooden block (cm)		
	1 st attempt	2 nd attempt	Average
A	32	30	31
B	45	43	44
C	27	29	28

- (a) (i) Based on the results above, which of the three lubricants was the most effective? Explain your answer. [1m]

- (ii) Why was it necessary to take more than one reading for the experiment? [1m]

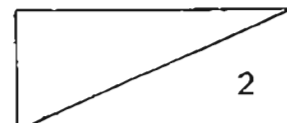

- (b) The cleaning attendant placed a sign outside a public toilet at a MRT station after her cleaning task.



Give a reason for the cleaning attendant for putting up the sign. [1m]

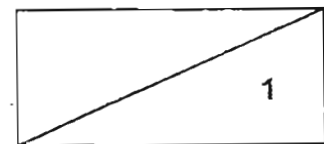

42. Ali set up an experiment as shown in the diagram below. He measured the angle by which the iron thumbtack moved from the vertical position as he increased the number of batteries. He recorded his observations in the table below.

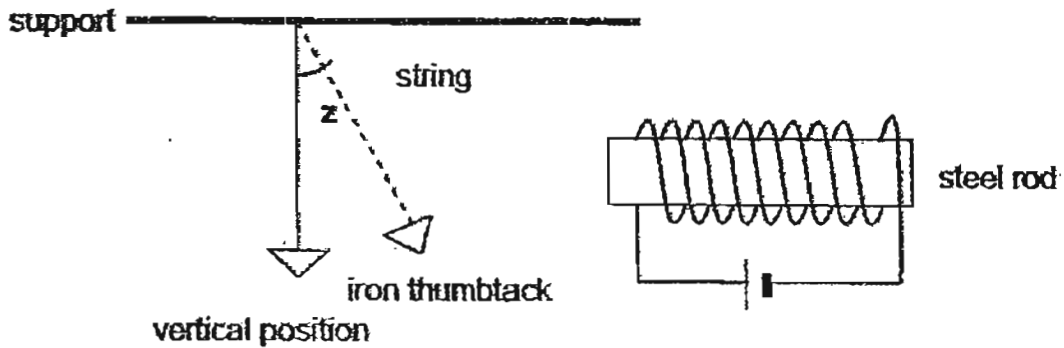

Number of batteries	0	1	2	3	4
Angle, Z ($^{\circ}$)	x	20	32	43	54

- (a) What is the value of x ? Give a reason for your answer. [1m]
- _____
- _____
- (b) What is the relationship between the number of batteries and Angle Z ? [1m]
- _____
- _____
- (c) Explain why the iron thumbtack moved away from the resting vertical position. [1m]
- _____
- _____

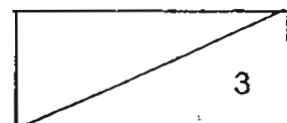

44. Jim filled three cups X, Y and Z with 300 ml of water at 90°C and left them in the Science Room at a room temperature of 26°C for 6 hours. The cups were made of different materials.

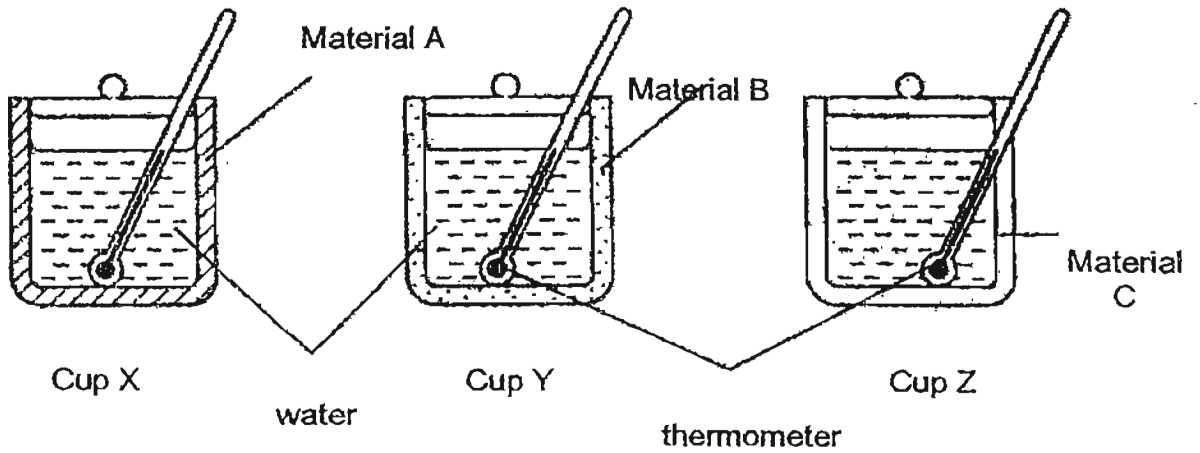

Next, Jim recorded the temperature of the water in each cup after every 1-hour as shown in the result table below.

Cups	Temperature in °C					
	After 1h	After 2h	After 3h	After 4h	After 5h	After 6h
X	64	48	38	32	26	?
Y	68	53	42	34	28	?
Z	76	62	50	42	36	32

BLANK PAGE

- (a) Using the readings in the result table, draw 3 line graphs to show the change in temperature of the water in each cup, X, Y and Z over 6 hours. Label each line graph clearly with "Cup X", "Cup Y" and "Cup Z". [3m]

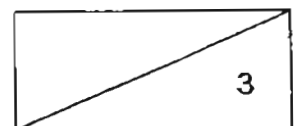
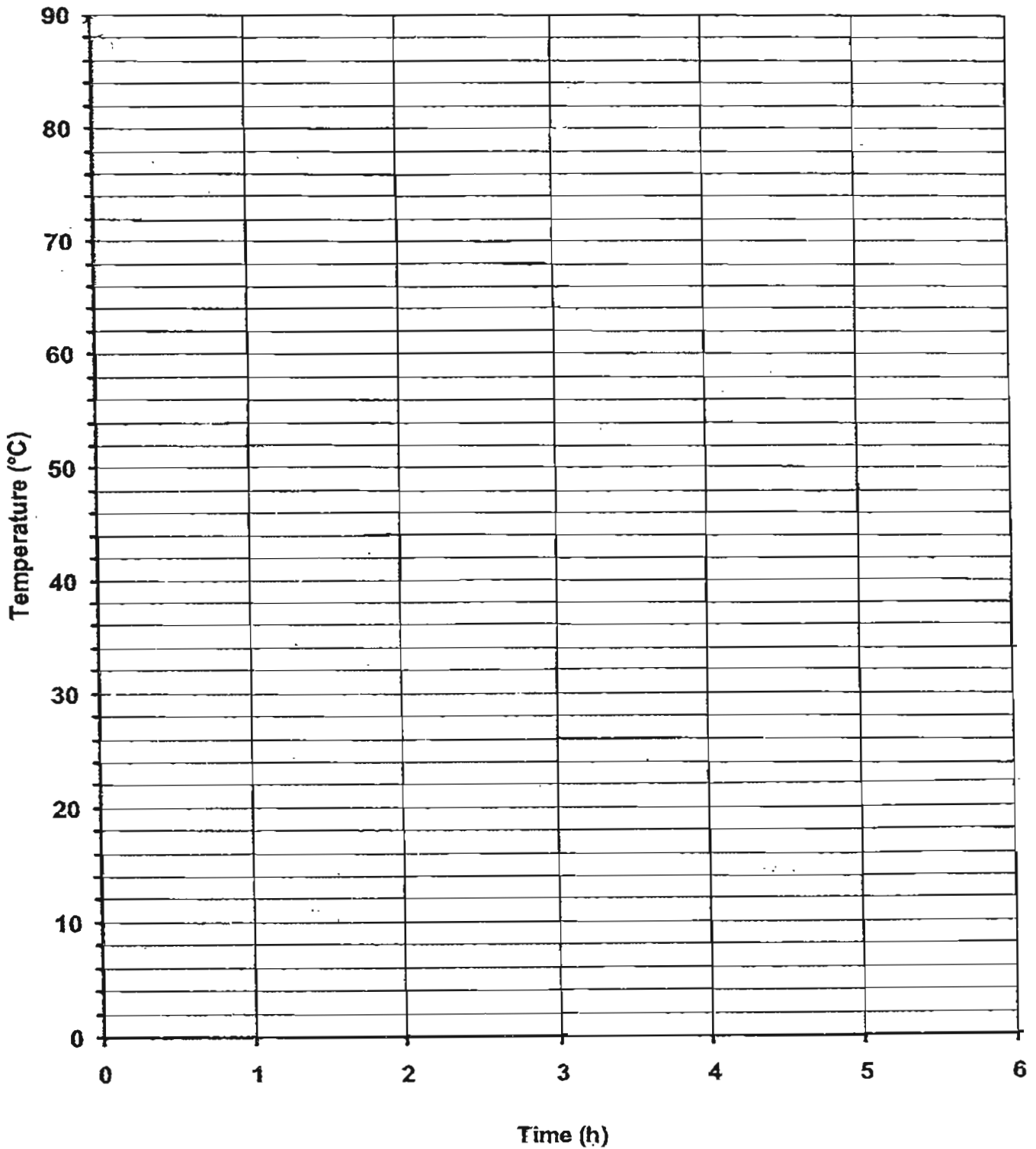

- (b) Jim would like a container to keep his porridge warm for the longest time. Which material, A, B and C should he use for the container? Give a reason for your answer. [1m]

End of Paper

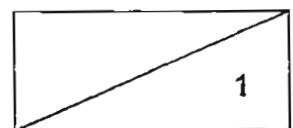



ANSWER SHEET

EXAM PAPER 2011

**SCHOOL : NAN HUA PRIMARY
SUBJECT : PRIMARY 6 SCIENCE**

TERM : CA1

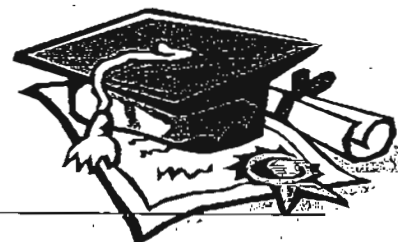

Q1	Q2	Q3	Q4	Q5	Q6	Q7	Q8	Q9	Q10	Q11	Q12	Q13	Q14	Q15	Q16	Q17
4	3	4	3	3	4	2	4	2	4	3	4	2	3	2	2	1

Q18	Q19	Q20	Q21	Q22	Q23	Q24	Q25	Q26	Q27	Q28	Q29	Q30
2	2	3	1	3	4	4	4	4	4	3	3	2

31)a) sun b) running water c) compressed spring d) battery
e) elastic potential energy f) chemical potential energy

32)a) The greater the speed, the more kinetic energy the falling flower pot possesses.
b) gravitational potential energy → kinetic energy → sound energy + heat energy
c) 1) use two balls of the same size but of different weight. 2) Drop both balls onto a sand bed from the same height. 3) Record the depth of the depression made by each ball on the sand bed.

33)a) Gravitational force.
b) The tennis ball does not float in the air and it is starting to drop.

34)a) D, B, A, C
b) There is friction between the hands of the boys and the ropes.

35)a) The length of the shadow will be about 2cm.
b) As angle W increases, the length of the shadow decreases. When the angle of the light source increases beyond 90°, the length of the shadow starts to increase.

36)a) i) Oxygen ii) It contains oxygen
b) Blue coloured light. The rate of photosynthesis is the highest resulting in the greatest amount of oxygen as shown in the largest number of oxygen bubbles produced.

37)a) The experiment was not a fair one as there can only be one independent variable which is the type of material so as to ensure that the change in result is due to the type of material and not factors like the thickness of the rod.
b) It is not a magnetic material.

38)a)The air gains heat from the candle flame and rises, pushing Cup A upwards.

b)No, I don't agree. When Ring X is heated, it expands but its mass remains unchanged. Hence, ring W and X remains at the same position.

39)a)i)When the card is pressed down, the rubber band gains elastic potential energy. When the card is released, the elastic potential energy is then converted into kinetic energy.

ii)He could press the card down even further.

40)a)He could use the magnet and put it outside the thin glass container. The steel disc will be attracted to the magnet and he could now lift the magnet towards the small opening.

b)No, because magnetism cannot pass through magnetic materials like iron and therefore, the steel disc will not be attracted.

41)a)i)B/ Lubricant B reduced the most friction between the wooden block and the surface of table and caused the wooden block to move the longest distance along the surface.

ii)To ensure a more reliable result.

b)It is to inform the public to be careful as the water has reduced the friction between the shoes and the wet floor and it will cause them to slip if they are not careful.

42)a)0° as the steel rod is not magnetized as there is no electricity going through the circuit, so it cannot the iron thumbtack.

b)The bigger the number of batteries the value Angle Z will be bigger.

c)When electricity passes through the circuit the steel rod becomes magnetized and attract the iron thumbtack towards it.

43)a)

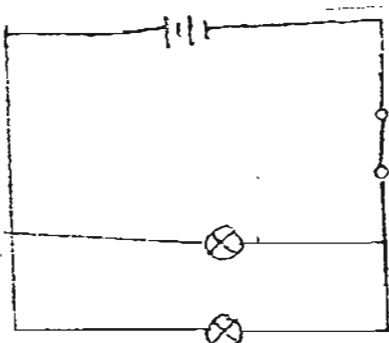

b)The number of batteries.

44)a)

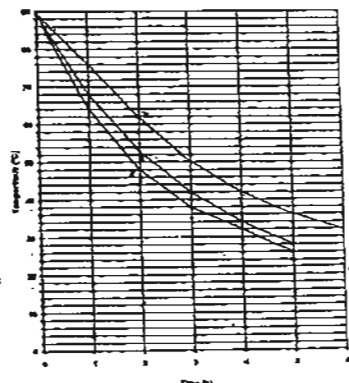

b)He should use material C as it is the best heat insulator of heat and so allows heat loss from the water to the surrounding air most slowly.