

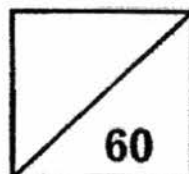

Rosyth School
First Semestral Assessment 2016
STANDARD SCIENCE
Primary 6



Name: _____

Total
Marks:

Class: Pr 6 _____ Register No. _____ Duration: 1 h 45 min

Date: 11 May 2016 Parent's Signature: _____

Booklet A

Instructions to Pupils:

1. Do not open the booklets until you are told to do so.
2. Follow all instructions carefully.
3. This paper consists of 2 booklets - Booklet A and Booklet B.
4. For questions 1 to 30 in Booklet A, shade the correct ovals on the Optical Answer Sheet (OAS) provided using a 2B pencil.
5. For questions 31 to 44, give your answers in the spaces given in the Booklet B.

* This booklet consists of 18 printed pages (including cover page).

Part I

For each question from 1 to 30, four options are given. One of them is the correct answer. Make your choice (1, 2, 3 or 4). Shade the correct oval (1, 2, 3 or 4) on the Optical Answer Sheet. **(60 Marks)**

- 1 Which of the following about all non-flowering plants and fungi are correct?

		Non-flowering plants	Fungi
A	Do they contain chlorophyll?	Yes	No
B	Do they feed on decaying matter?	No	Yes
C	Do they reproduce by spores?	No	Yes

- (1) B only
(2) A and B only
(3) A and C only
(4) A, B and C
- 2 Charlie puts ten guppies into an aquarium and feeds them every day. He does not add in any more guppies into the aquarium. The graph below shows how the number of guppies in the aquarium changes over the next few months.

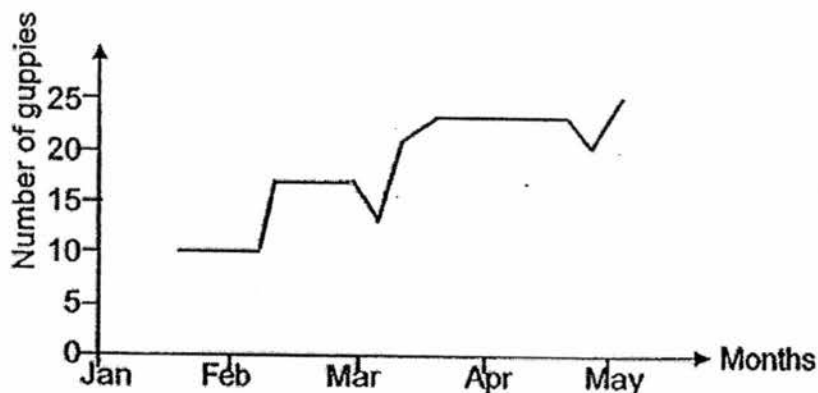

Which characteristic(s) of living things is/are shown in the graph?

- A Living things die.
B Living things grow.
C Living things reproduce.
- (1) B only
(2) C only
(3) A and C only
(4) A, B and C

3 One of the characteristics of living things is growth. Which one of the following statements best describes growth?

- (1) It is the process whereby cells die and are replaced.
- (2) It is the process whereby damaged cells are repaired.
- (3) It is the process whereby cells divide and increase in size.
- (4) It is the process whereby cells divide and increase in numbers.

4 The diagram below shows a plant cell.

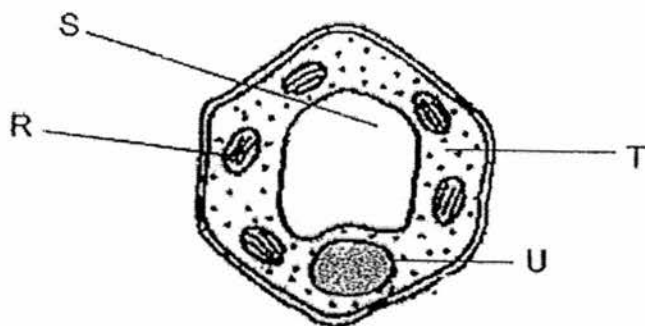

In which part of the cell is sugar made?

- (1) R
- (2) S
- (3) T
- (4) U

5 Study the diagram below.

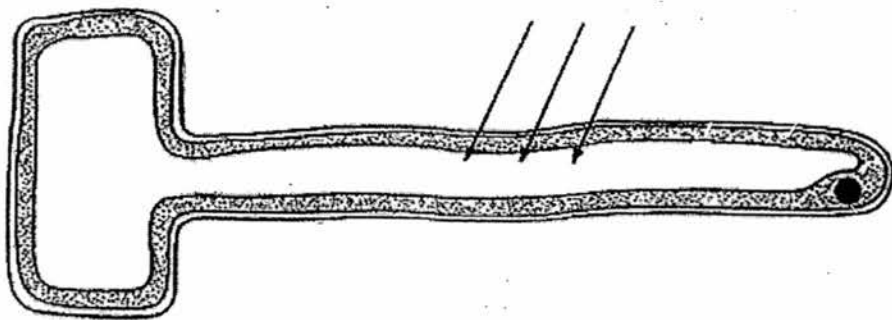

The arrows show the movement of mineral salts into a plant cell. Which of the following shows the correct order of the parts that the mineral salts have to pass through to reach the centre of the cell?

- (1) cell membrane → cytoplasm → cell wall → cell sap
- (2) cell wall → cell membrane → cytoplasm → cell sap
- (3) cell wall → cell membrane → cell sap → cytoplasm
- (4) cell membrane → cell wall → cell sap → cytoplasm

- 6 The diagram below shows some animals and plants sealed in a glass container.

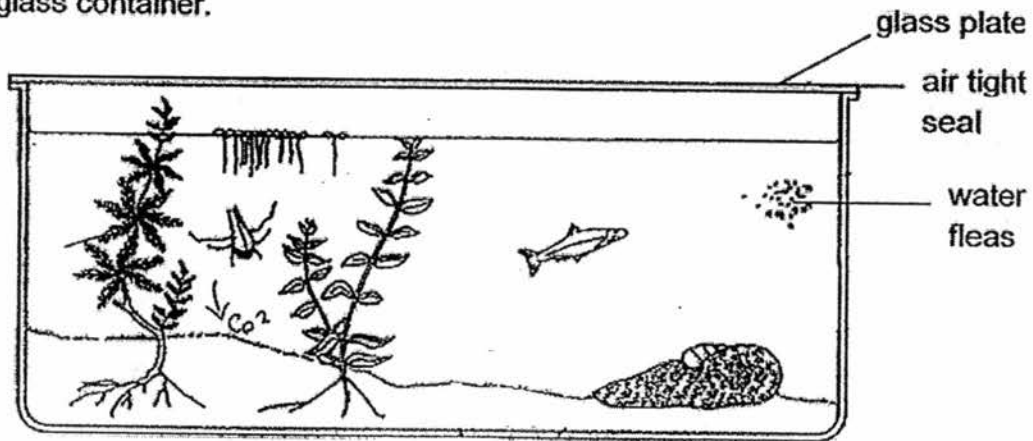

What must be supplied to keep the organisms alive for the longest possible time?

- (1) oxygen
 - (2) food
 - (3) carbon dioxide
 - (4) light
- 7 Rosy carried out an experiment to see how the amount of carbon dioxide affects the rate of photosynthesis. Which one of the following correctly shows the results if she had carried out a fair test?

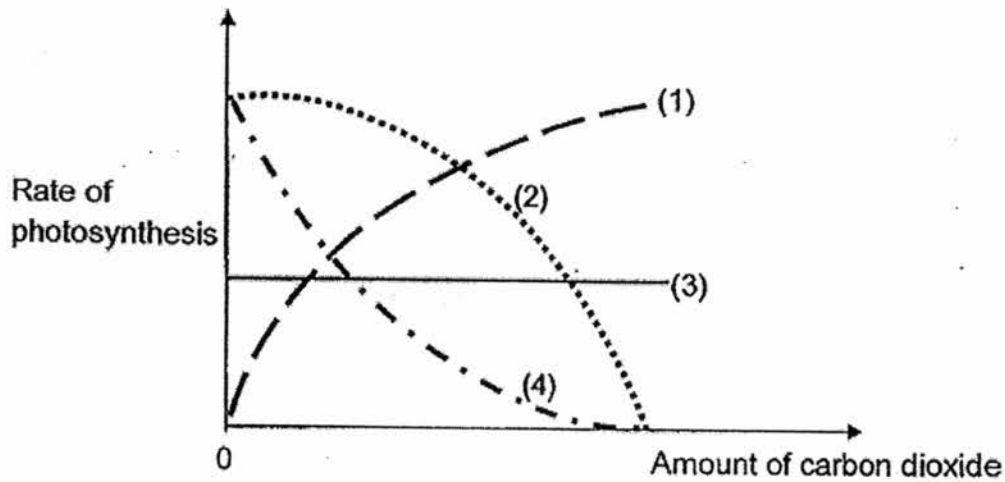

- 8 The diagram shows an experiment to find out whether light is needed for photosynthesis.



Which one of the following is the most suitable control for the experiment?

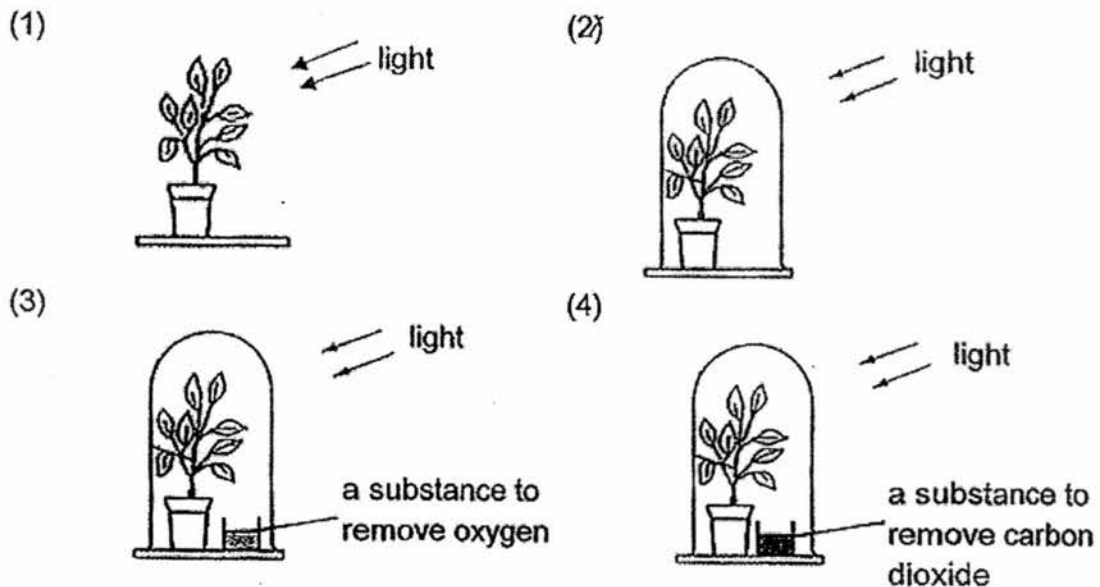

- 9 Study the diagram below.

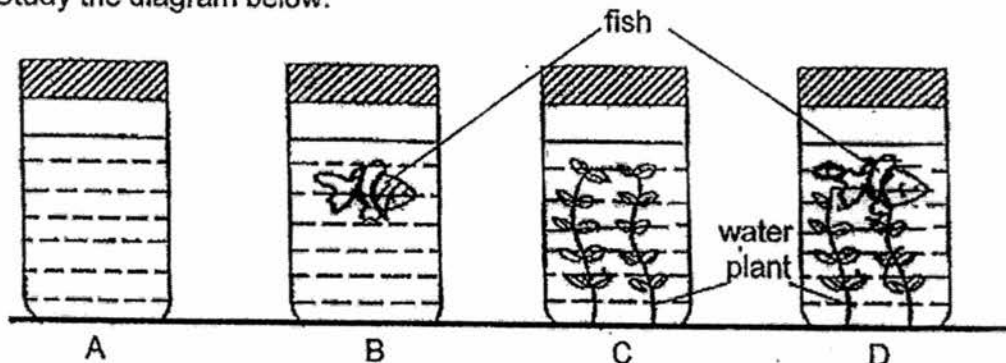

Four sealed glass containers of the same size were set up as shown. They were left in the sunlight for six hours.

At the end of the experiment, which container of water would contain the least amount of carbon dioxide?

- (1) Container A (2) Container B
(3) Container C (4) Container D

- 10 Leela carried out an experiment to find out if the number of leaves of a plant affects the rate of photosynthesis.

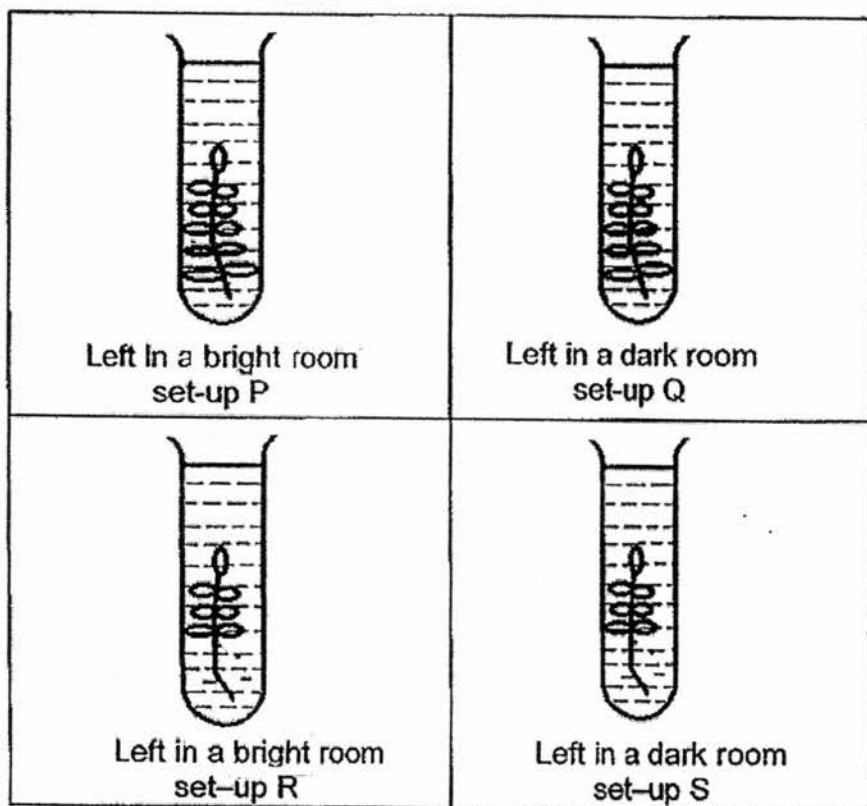

Which two of the above set-ups should be used in the experiment?

- (1) P and Q
 (2) P and R
 (3) Q and R
 (4) Q and S
- 11 Some pupils counted the birds that visited the field soon after the grass was cut.

Which one of the following is a possible observation and explanation?

	Observation	Explanation
(1)	More birds visited the field.	The insects were exposed, making it easier for the birds to catch them.
(2)	More birds visited the field.	The birds were eating the cut grass which could be easily digested.
(3)	Less birds visited the field.	Many insects had been killed so the birds had fewer insects to feed on.
(4)	Less birds visited the field.	The field could no longer provide a shelter for the birds.

- 12 The diagram below shows some vegetables and weeds growing in a plot of land.

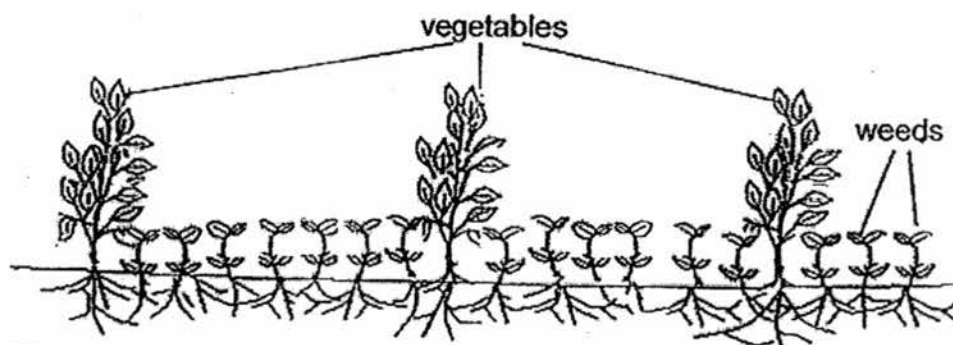

The presence of weeds prevented the vegetables from growing healthily. Which of the following do the vegetables need to compete with the weeds for?

- A water
- B oxygen
- C space
- D nutrients
- E sunlight

- (1) A, C and D only
- (2) B, C and E only
- (3) A, C, D and E only
- (4) A, B, C, D and E

- 13 Study the food web below.

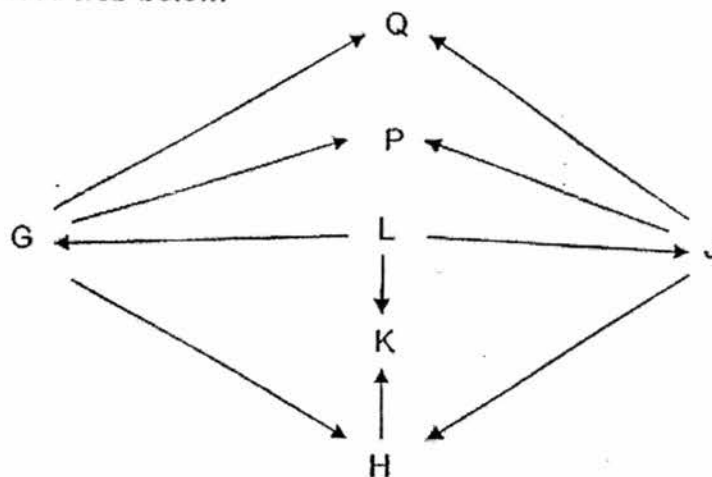

What is likely to happen to the population of H if the population of P is wiped out by a disease?

- (1) It will stay the same because H do not eat P.
- (2) It will stay the same because Q will eat more food.
- (3) It will increase because H will have more food to eat.
- (4) It will decrease because there will be more competition with Q for food.

- 14 The leopard gecko lives in the desert. The two line graphs below show the relationship between the activity level of the leopard gecko and the temperature changes of the desert in a day.

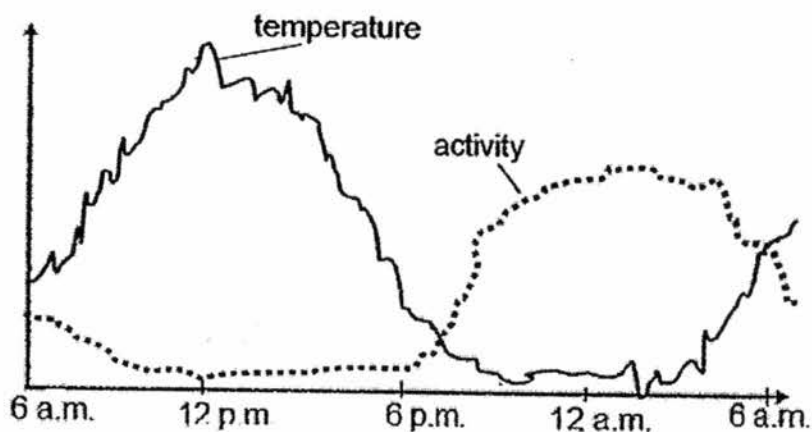

What can you infer about the leopard gecko based on the graph shown above?

- A Its activity increases as the temperature increases.
- B It is most active in the night when the temperature is cooler.
- C Its behavioural adaptation helps it to survive in the hot desert.
- D It is structurally adapted to be active when the temperature is hot.

- (1) A and B only
- (2) B and C only
- (3) C and D only
- (4) B and D only

- 15 Steve set up the experiment below. He observed the behaviour of the fruitflies in the 2 set-ups at ten-minute intervals for one hour. The wire netting kept the fruitflies in while allowing air exchange.

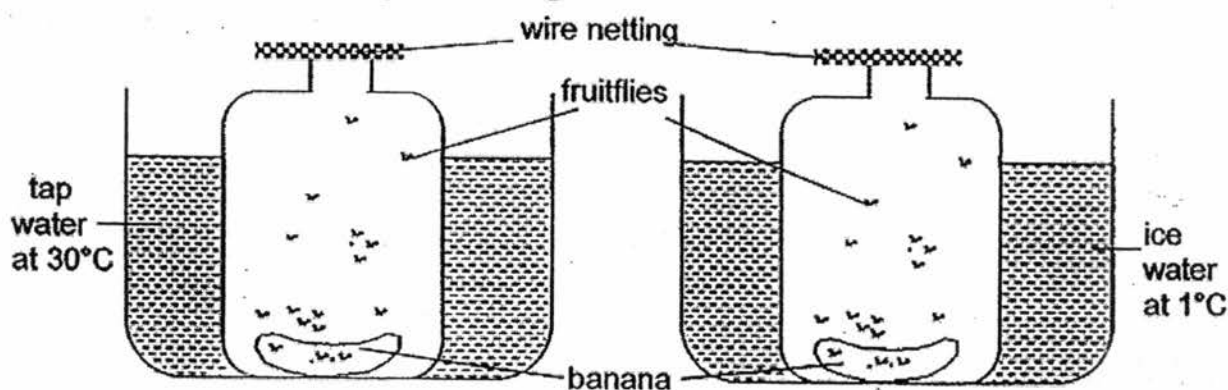

Which of the following is the aim for Steve's experiment?

- (1) To find out which type of food fruitflies prefer.
- (2) To find out if fruitflies prefer cold to warm surroundings.
- (3) To find out which is the best temperature for fruitflies to survive.
- (4) To find out how temperature of the surrounding affects the activity level of fruitflies.

- 16 Anna cut out a square of dimension 1cm by 1cm from a piece of opaque paper and taped the paper to one end of a paper tube.



A torch was fixed onto the other end of the paper tube. The torch was fixed at different distances, in front of a wall in a completely dark room and switched on as shown in the diagram below.

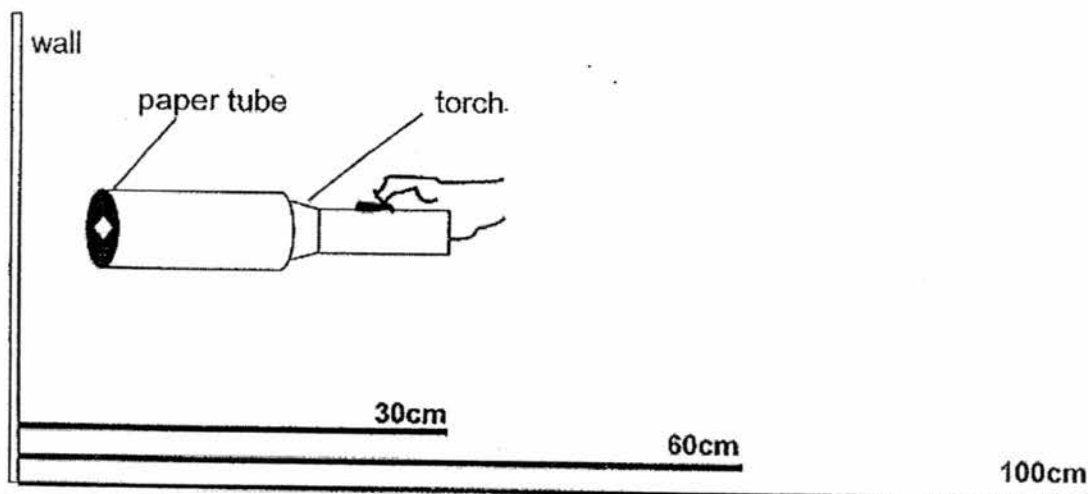

A shadow was cast on the wall and Anna made the following statements.

- A The shadow formed on the wall was bigger when the torch was nearer to the wall.
- B The size of the shape formed on the wall was the same at 30cm and 60cm.
- C At a distance of 60cm, the shape formed on the wall was smaller than at a distance of 100cm.

Which of the statement(s) about the shadow formed on the wall is/are correct?

- (1) A only
- (2) C only
- (3) B and C only
- (4) A, B and C

- 17 In the diagram below, Jonny was standing behind a piece of cloth. He was not able to see the table.

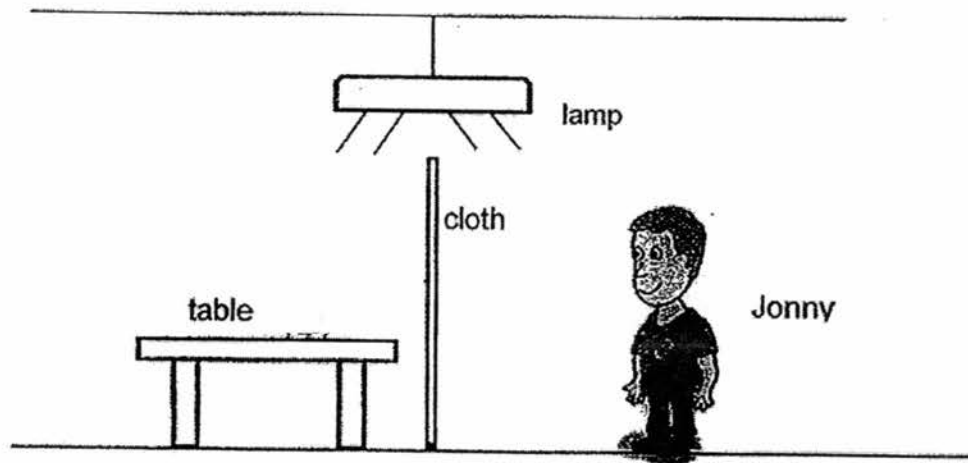

Which one of the following explains why Jonny was not able to see the table?

- (1) The table is not a light source.
- (2) The table did not reflect light from the lamp.
- (3) The cloth did not allow light to pass through.
- (4) The table did not allow light to pass through.

18 Study the flowchart below.

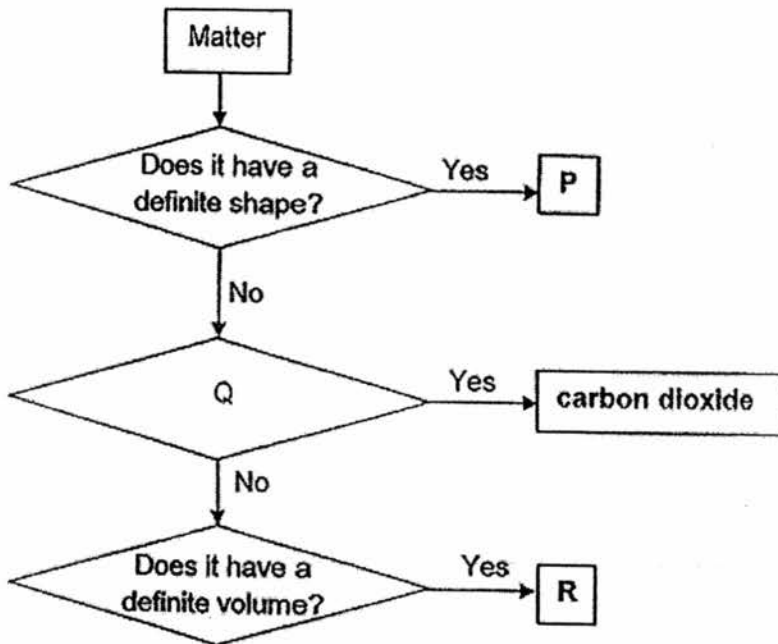

Which of the following represents P, Q and R?

	P	Q	R
(1)	smoke	Can it be expanded?	brick
(2)	milk	Can it be expanded?	smoke
(3)	brick	Can it be compressed?	milk
(4)	brick	Can it be compressed?	smoke

- 19 Sunny balanced two identical glass containers, P and Q, each containing 250ml of water on a balance as shown in the diagram below.

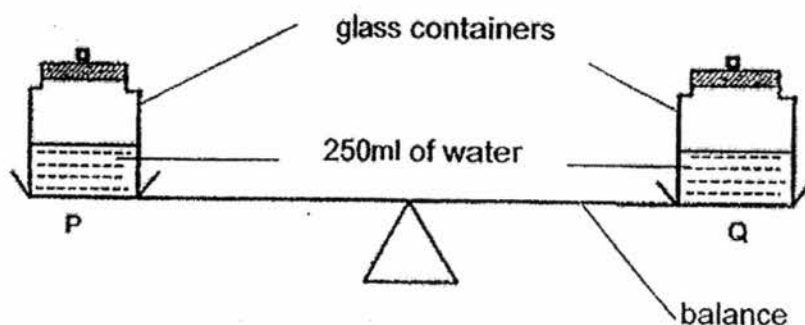

Through a special hole in the cap of the containers, Sunny pumped in an additional 50ml of air into container P only.

Which of the following statement(s) is/are correct?

- A The volume of air in container P increased.
- B The side of the balance with container P moved downwards.
- C The mass of air in container P remained the same.

- (1) A only
- (2) B only
- (3) A and B only
- (4) B and C only

- 20 Air was blown into a balloon to inflate it partially as shown in the diagram below.

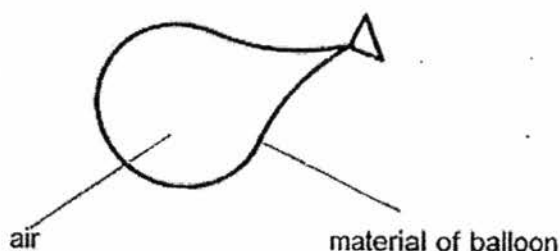

The partially inflated balloon was placed into a basin of hot water. After 30 minutes, it was observed that the balloon was bigger than before.

Which one of the following best explains the observation?

- (1) Heat flowed from the hot water to the air inside the balloon.
- (2) Heat flowed from the hot water to the material of the balloon.
- (3) Heat flowed from the material of the balloon to the air inside the balloon.
- (4) Heat flowed from the air inside the balloon to the material of the balloon.

- 21 Martin filled a beaker with water at 80°C . A piece of ice in a cylinder was placed into the beaker of water as shown below. The experiment was conducted in a room where temperature was 28°C .

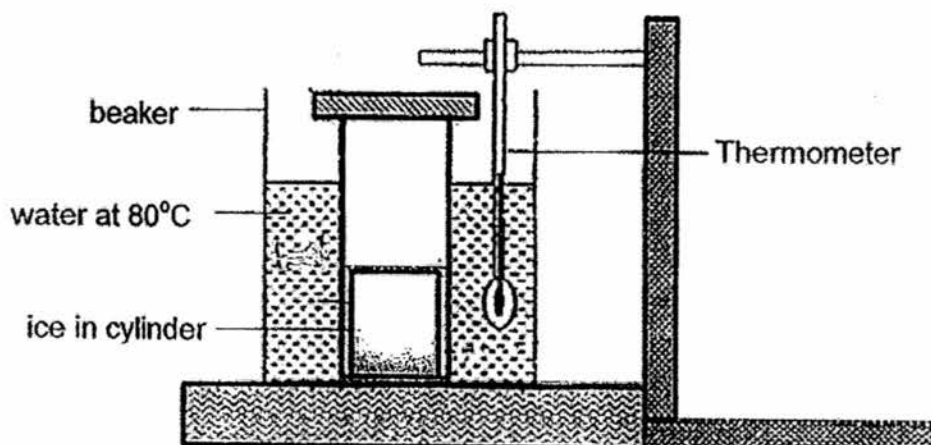

Which of the following statement(s) is/are correct about his observation 20 minutes later?

- A The ice had melted as it lost heat to the water in the beaker.
 B The ice had melted as it gained heat from the water in the beaker.
 C The temperature of water increased as the ice in the cylinder lost heat to the water.
 D The temperature of water decreased as it had lost heat to the ice in the cylinder.

- (1) A only
 (2) C only
 (3) B and C only
 (4) B and D only

- 22 The table below shows the freezing and boiling points of substances X, Y and Z.

Substances	Freezing point ($^{\circ}\text{C}$)	Boiling point ($^{\circ}\text{C}$)
X	39	93
Y	3	120
Z	19	79

Which of the substances X, Y and Z is/are in the liquid state at 81°C ?

- (1) X only
 (2) Y only
 (3) X and Y only
 (4) Y and Z only

- 23 Ahmad poured 1000 ml of water into each container, A, B, C and D, as shown in the diagram below.

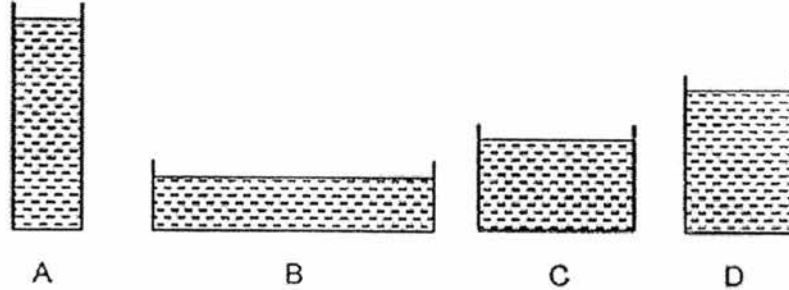

The 4 containers were each placed under a fan moving at a constant speed. After 6 hours, Ahmad measured the amount of water left in each container and recorded the results using a bar graph.

Based on the information above, which one of the following graphs shows the correct results?

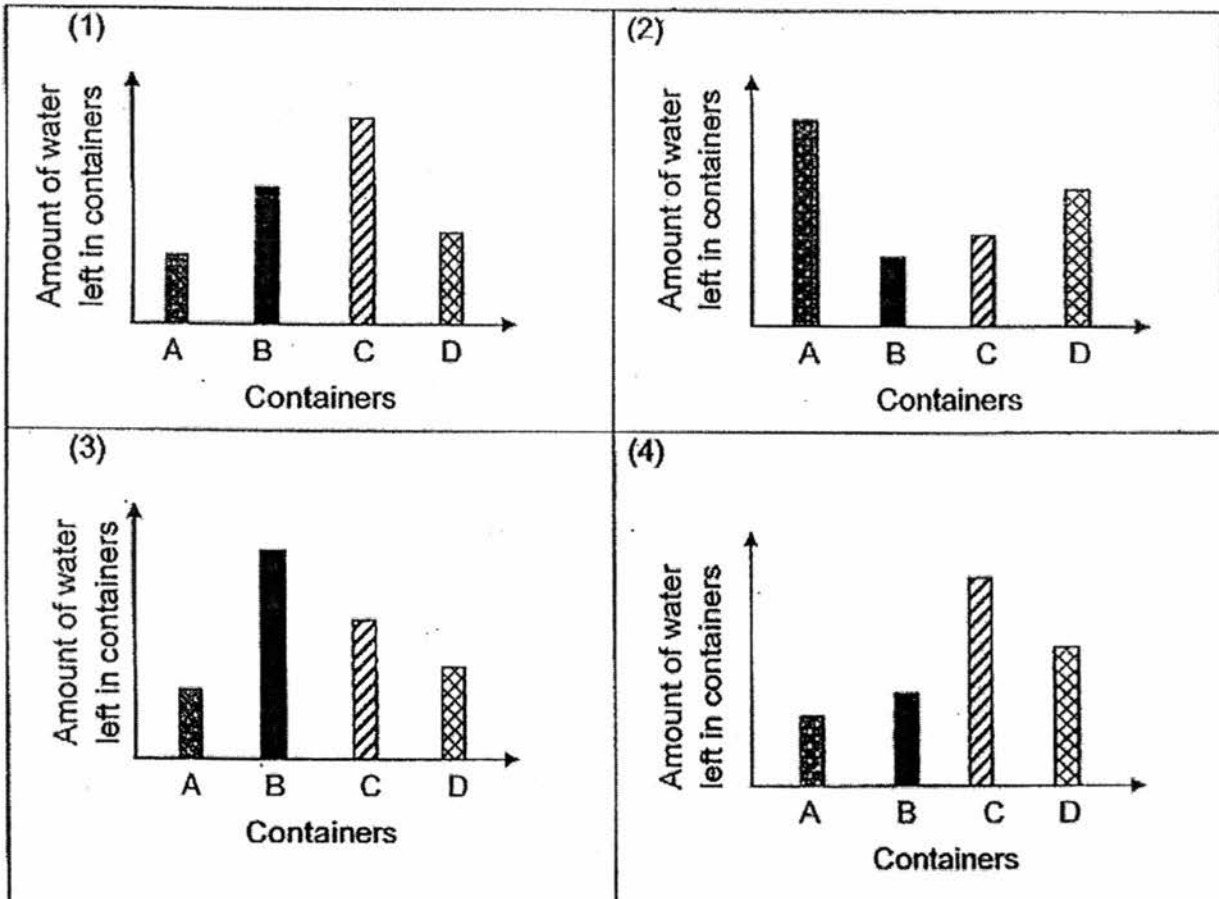

24 Study the two diagrams below.

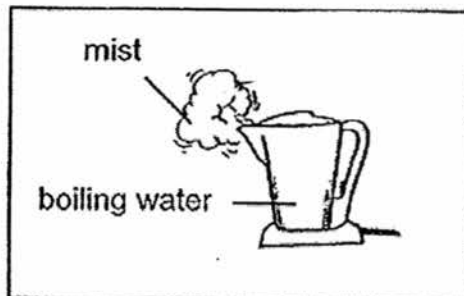
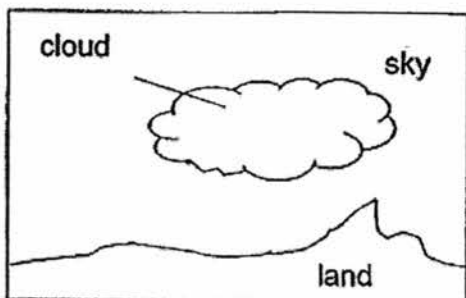

How are the clouds in the sky and the mist formed around the spout of a kettle of boiling water similar?

- A Both are made up of water vapour.
- B Both are made up of water droplets.
- C Both are formed by water evaporating into the surrounding air.
- D Both are formed by water vapour losing heat to the surrounding air.

- (1) A and C only
- (3) B and C only

- (2) A and D only
- (4) B and D only

25 The diver in the diagram below started her dive standing at point W. The arrow traces her path in the dive.

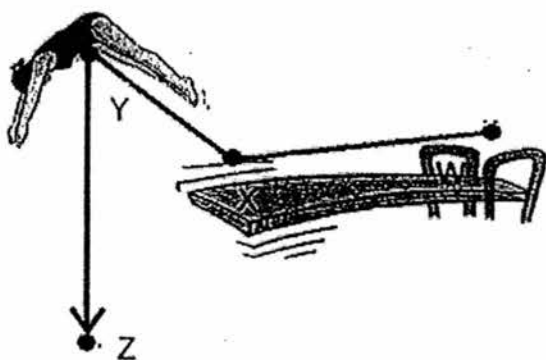

Based on the diagram above, at which point in her dive was elastic potential energy converted to kinetic energy?

- (1) W
- (3) Y

- (2) X
- (4) Z

- 26 The diagram below shows how a swing moves from the start position A to B and then to C.

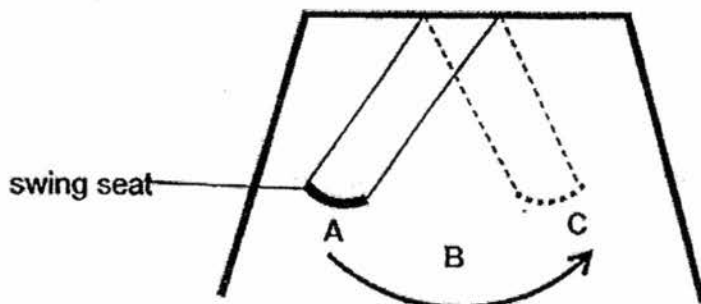

Which one of the following correctly shows the changes in potential energy and kinetic energy of the seat as the swing moves from position A to C?

	Potential energy from A to B	Kinetic energy from B to C
(1)	increasing	decreasing
(2)	decreasing	increasing
(3)	increasing	increasing
(4)	decreasing	decreasing

- 27 Two pieces of metals, X and Y, are placed side by side as shown in the two experiments. Results are shown below.

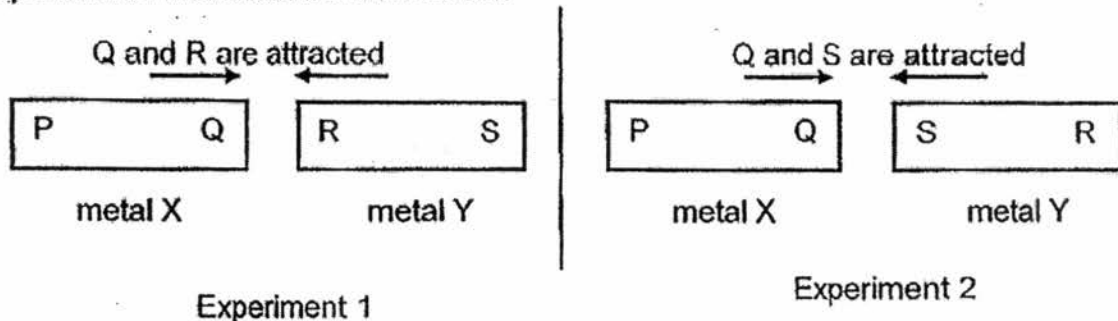

Based on the information given, which of the following statement(s) is/are true?

- A Both metals X and Y are magnets.
 B Q and R are definitely unlike poles.
 C Both metals X and Y are made of magnetic materials.
- (1) A only
 (2) C only
 (3) A and B only
 (4) B and C only

28 Study the set-up shown below.

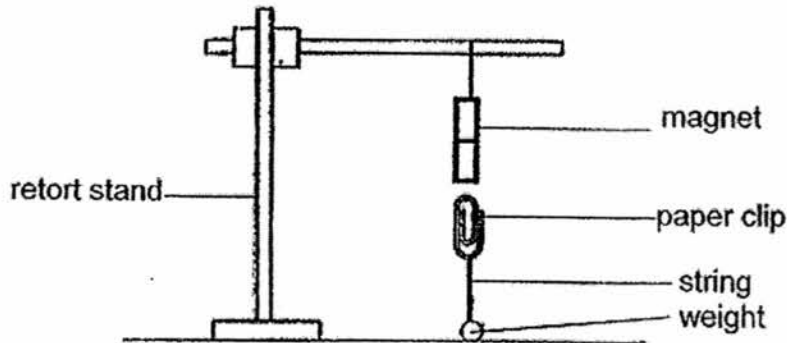

Which of the following force(s) is/are acting on the paper clip?

- A magnetic force
- B gravitational force
- C frictional force

- (1) A only
- (2) A and B only
- (3) A and C only
- (4) A, B and C

29 Gabriel set up an experiment using four similar elastic bands to find out how the mass of the weights affects the extension of an elastic band.

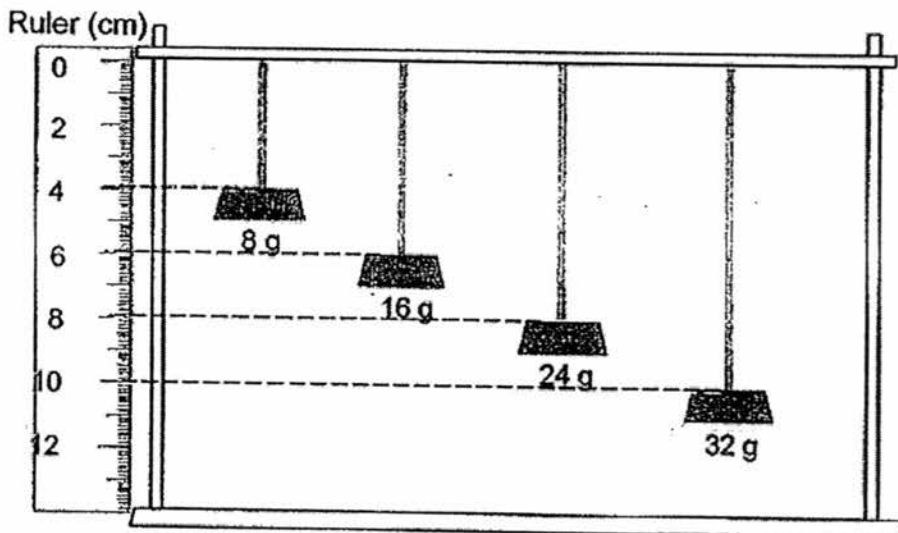

Which of the following statement(s) is/are correct about this set-up?

- A The elastic band is exerting a downward force.
- B The weights exert a downward force on the elastic band.
- C When a mass of 24 g is hung on the elastic band, the extension of the elastic band is 6 cm.

- (1) B only
- (2) A and C only
- (3) B and C only
- (4) A, B and C

- 30 Ling conducted an experiment using a similar wooden block and 4 ramps. The ramps have surfaces of different textures. She carried out the experiment with each set-up individually.

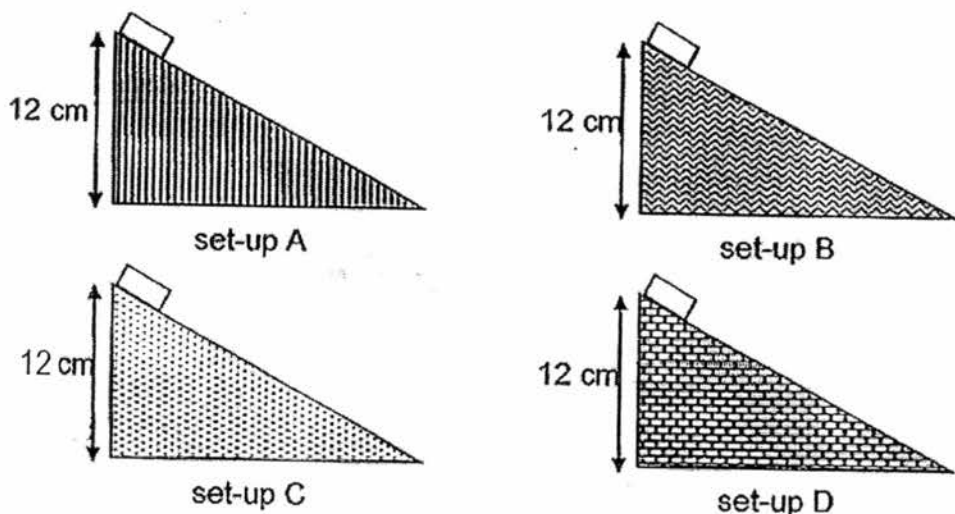

She released the wooden block from the top of each ramp and measured the distance moved by the block before it came to a stop for each set-up and recorded it in the table below.

set-up	A	B	C	D
distance moved by the block (cm)	20	8	6	11

Which one of the following most likely shows the material used for the surface of the ramp in each set-up?

	set-up A	set-up B	set-up C	set-up D
(1)	glass	sandpaper	carpet	polished wood
(2)	carpet	polished wood	glass	sandpaper
(3)	polished wood	glass	sandpaper	carpet
(4)	sandpaper	polished wood	carpet	glass



Rosyth School
First Semestral Assessment 2016
STANDARD SCIENCE
Primary 6

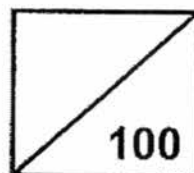

Name: _____

Total
Marks:

Class: Pr 6 _____

Register No. _____

Duration: 1 h 45 min

Date: 11 May 2016

Parent's Signature: _____

Booklet B

Instructions to Pupils:

1. For questions 31 to 44, give your answers in the spaces given in Booklet B.

	Maximum	Marks Obtained
Booklet A	60 marks	
Booklet B	40 marks	
Total	100 marks	

* This booklet consists of 17 printed pages (including cover page).

Part II

For questions 31 to 44, write your answers in the space provided. **(40 Marks)**

31 The diagram below shows animal Q.



This animal is originally found in country R that experiences short summers and long winters. It flies to Singapore between September and March when its country of origin experiences cold winter.

(a) Name 2 characteristics of living things that are shown in this behaviour by animal Q. [2]

Characteristic 1: _____

Characteristic 2: _____

(b) Which group of animals does animal Q belong to? Explain your answer. [1]

- 32 Aziz found a single-cell organism, organism Z, in a freshwater pond. The diagram below shows how organism Z looks like under the microscope.

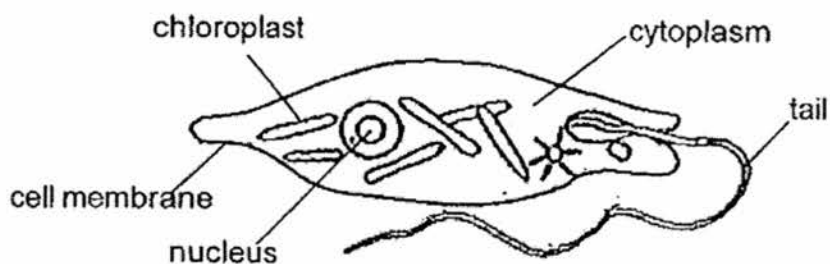

- (a) Aziz concluded that organism Z does not need to feed on other organisms. Do you agree with him? Explain your answer. [1]

- (b) State one part of a typical plant cell that is not present in organism Z. [1]

When Aziz cut away the tail of organism Z as shown in the diagram below, he observed that a new tail started to form.



- (c) How was it possible for organism Z to form a new tail? [1]

33 Peter set up the experiment as shown below.

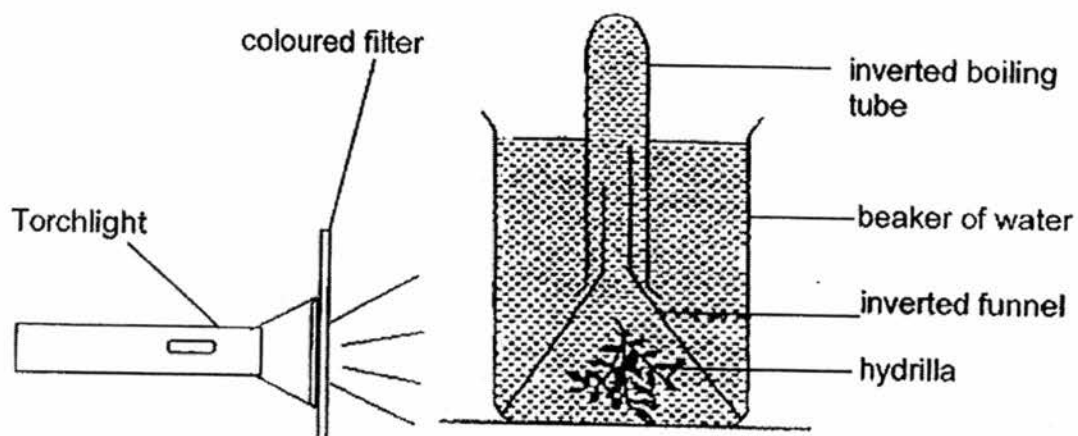

He placed a coloured filter in front of the torchlight and shone the torch at the hydrilla plant for 15 minutes. He then repeated the experiment using another coloured filter.

(a) What is the aim of the experiment? [1]

(b) Identify the variable to measure for the experiment. [1]

34 The diagram below shows a food chain in a habitat.

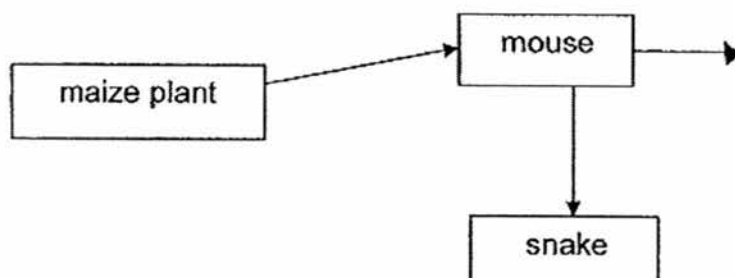

An organism X was introduced to the habitat. As a result, the population of mice decreased.

(a) Draw organism X in the food chain above. [1]

(b) Name two physical characteristics of the environment that will affect the growth of the maize plant. [1]

(c) If all the snakes are killed, what will be the immediate effect on the maize plants? Explain your answer clearly. [1]

- 35 Ahmad set up an experiment to find out the preferred living conditions of three types of organisms P, Q and R. First, he filled parts A and B of a round tray with wet soil and parts C and D with dry soil. Next, he covered parts A and D with black paper. He put 20 of each type of organism P, Q and R, in the centre of the tray. After one hour, he counted the number of organisms found in each part of the tray.

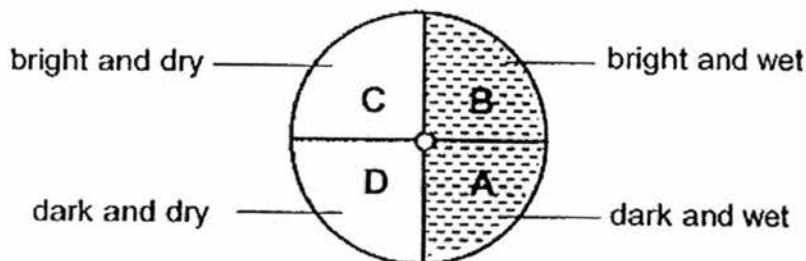

Organism	Number of organisms in each part of the tray			
	A	B	C	D
P	1	0	10	9
Q	9	1	0	10
R	18	2	0	0

- (a) Why did Ahmad put the organisms in the centre of the tray at the start of the experiment? [1]

The organisms were then returned to their natural environment. Ahmad continued to study their number and monitored the amount of rainfall in their natural environment over a period of time. He drew a graph to show his findings.

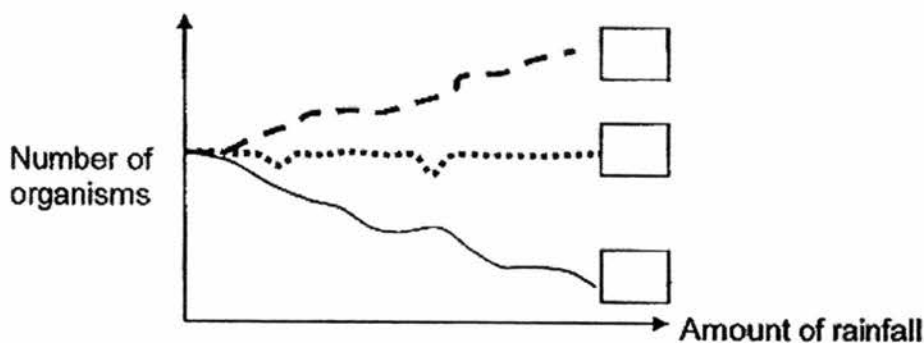

- (b) Based on the results of Ahmad's experiment, write the letters P, Q and R into the correct boxes in the graph above to represent the three types of organisms. [1]

36 The diagram below shows four different layers of a typical rainforest.



(a) Why are there ~~are~~ fewer plants found on the forest floor than the upper layers? [1]

(b) Why do the plants in Layer 1 have large leaves? [1]

The diagram below shows the leaves of a typical plant in Layer 2. The leaves of these plants have adapted to cope with exceptionally high rainfall by having drip tips. These drip tips enable rain drops to run off quickly.

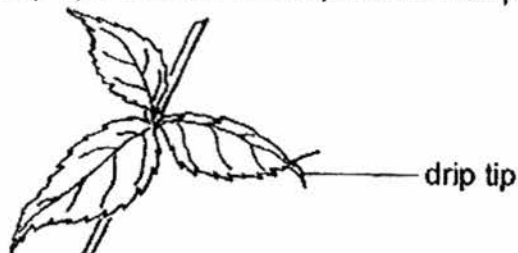

(c) Why do plants in Layer 2 need to get rid of the water on its leaves quickly? [1]

- 37 The picture below shows a stick insect. It is not easily seen by its predators as it is able to camouflage itself among the branches of a tree in the forest.

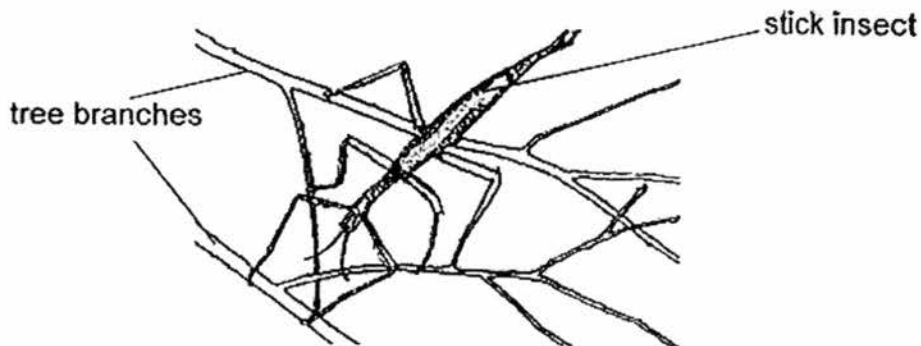

- (a) How is the stick insect structurally adapted to avoid being seen by its predators? [1]

The diagram below shows an egg of a stick insect.



The egg has a protruding structure which is full of sugar. The ants carry the egg down into their nest underground where they eat the sugar but leave the egg. Ants usually leave the existing nest to build a new nest after 6 months. The stick insect eggs can take up to a year to hatch.

- (b) How does the ant's behaviour benefit itself and the stick insect? [2]

Benefit for ants: _____

Benefit for stick insect: _____

- (c) Why are young stick insects that hatch from the eggs not eaten by the ants? [1]

38 Ken placed 4 different objects in front of the torchlight as shown below.

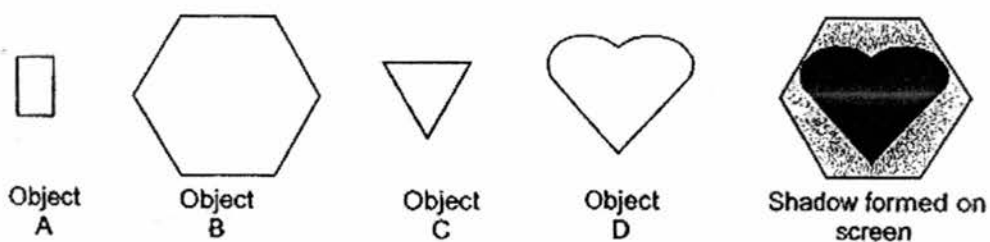
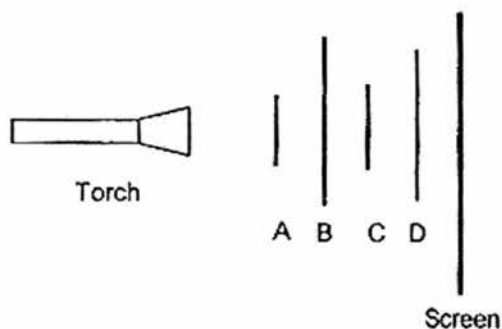

(a) Read the following statements and put a tick (✓) in the correct boxes. [2]

		True	False	Not possible to tell
i)	A is translucent.			
ii)	B is transparent.			
iii)	C is opaque.			
iv)	D is opaque.			

(b) List 2 ways in which he can increase the size of the shadow cast on the screen. [1]

- (i) _____
- (ii) _____

- 39 Ethan designed the device shown below to clean both sides of his window panes.

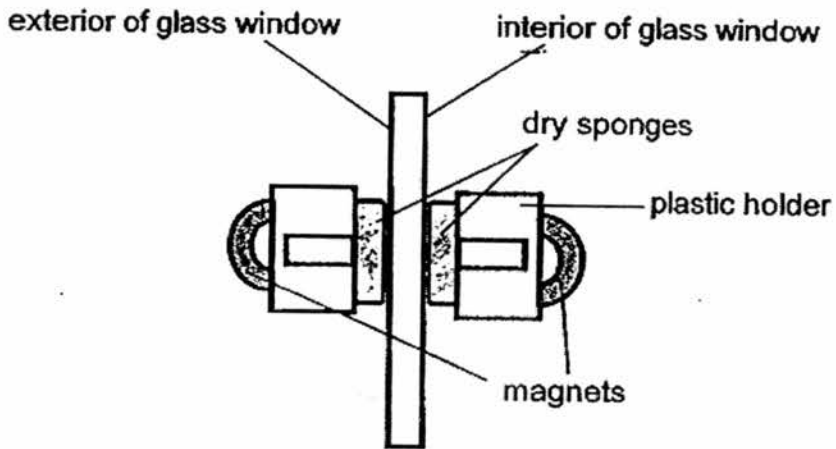

- (a) Identify all the forces acting on the device as Ethan starts moving it to clean the window panes? [1]

- (b) Next, Ethan dipped the sponges in water. He tried to put the device on the window panes as shown above but it slid down. Explain why that happened. [1]

- 40 Bala conducted 2 experiments to find out more about matter. In the first experiment, he moulded a piece of plasticine into shape X as shown below. Then he measured its mass and volume.

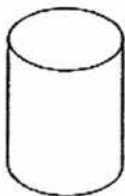

X

Using the same piece of plasticine, he moulded it into another two other shapes Y and Z as shown below and measured their masses and volumes each time.

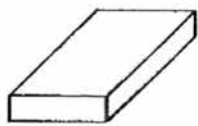

Y

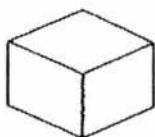

Z

He then made the following statements about plasticine.

Statement P: Plasticine can be compressed.

Statement Q: Plasticine has an indefinite shape.

- (a) Which statement, P or Q, is not correct? Explain your answer.

[1]

Question 40 continues on page 11

In the second experiment, Bala took a deep breath and blew into the tube twice in the set up shown below.

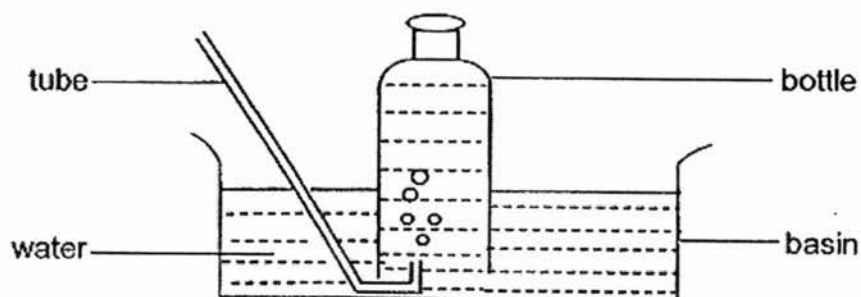

The results of the experiment are shown in the table below.

Height of water in the bottle at the beginning of the experiment (cm)	Height of water in the bottle after the 1 st blow (cm)	Height of water in the bottle after the 2 nd blow (cm)
10	8.3	7.9

- (b) Why was there a decrease in the height of water in the bottle each time when Bala blew into the tube? [2]

41 Pei Hwa set up the experiment as shown below.

Two similar cylindrical steel heaters, X and Y, of the same diameter and height but of different thickness, were both heated up to 130°C . Two similar beakers, each filled with 100ml of water, were placed on the cylindrical steel heaters.

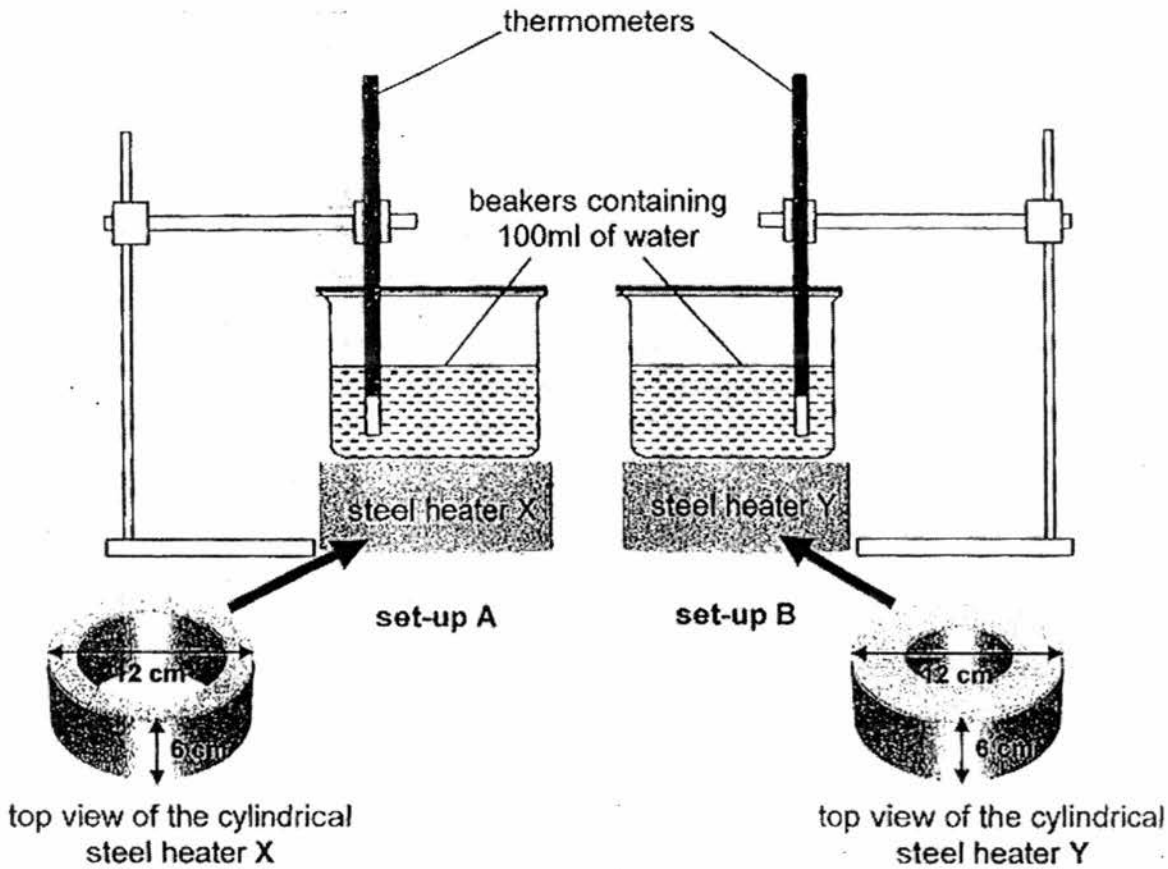

(a) After 15 minutes, he recorded a higher temperature of water in set-up B than in set-up A. Explain why. [2]

Question 41 continues on page 13

Pei Hwa conducted another experiment. He poured the same amount of water into three containers A, B and C made of different materials. The containers were then placed on the same cylindrical steel heater as shown in the diagram below.

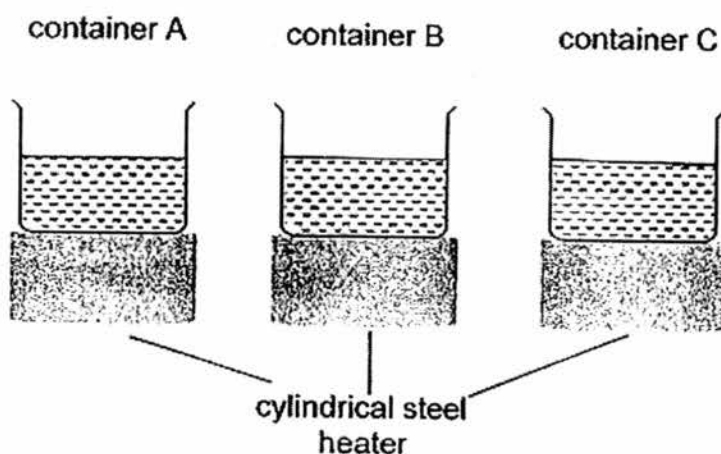

After 15 minutes, he observed the amount of water left in the containers.

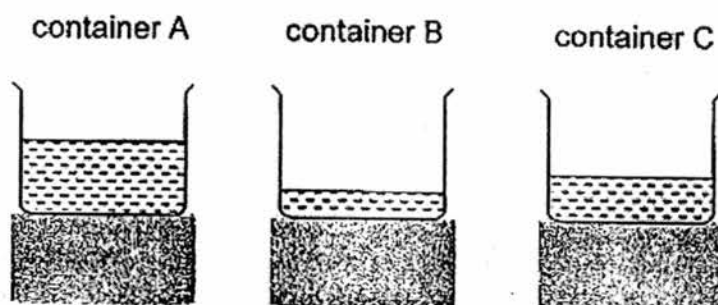

(b) From the different amount of water left in the containers, what can he conclude about the materials of the containers? [1]

- 42 During winter time, the heater installed in the bus was switched on to keep the passengers warm while they travelled from one place to another.

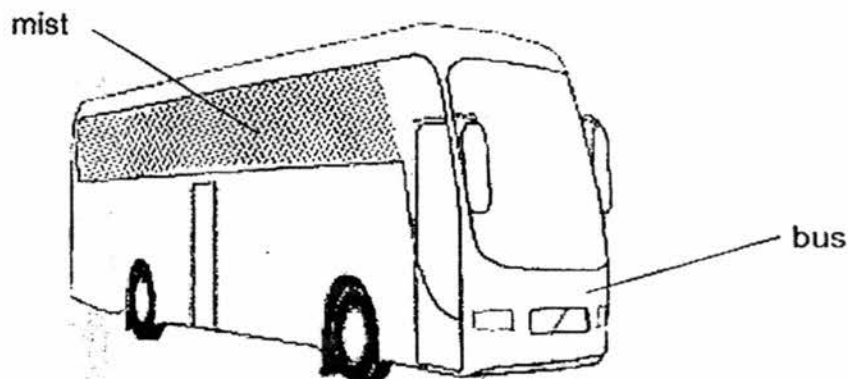

After travelling on the road for a while, mist was formed on the inner surface of the window in the bus.

- (a) Explain how the mist was formed on the inner surface of the window. [2]

A word "winter" was written on the inner surface of the window with a finger as shown below.



- (b) After a while, the word disappeared without anyone wiping it away. Explain how it happened. [1]

- (c) The heater was switched off after the bus reached the terminal. The surface of the window became clear after a while. Explain why. [1]

- 43 A hair dryer was used to blow a balloon which remained suspended in the air as shown below.

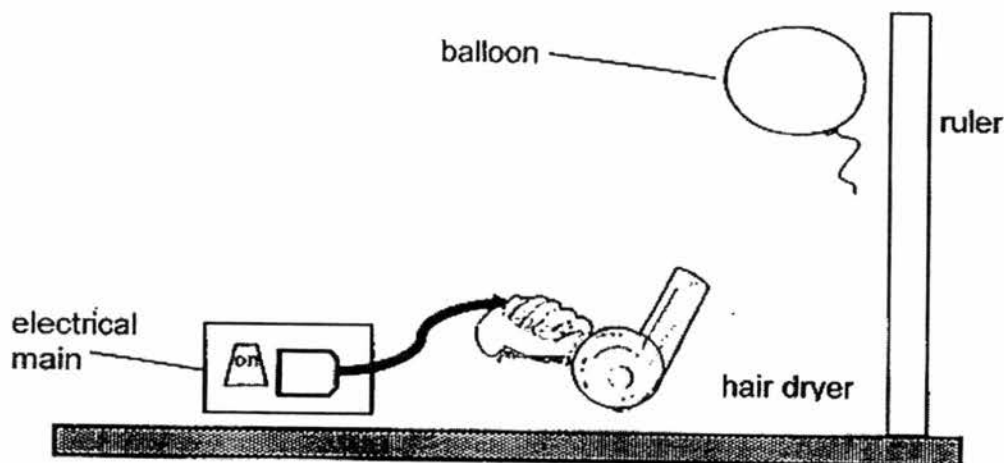

The height of the balloon from the ground was measured as the speed of the hair dryer was changed. The results were recorded as shown below.

Height of balloon (cm) from the ground	1 st reading	2 nd reading	3 rd reading	Average reading
Speed of hair dryer				
Low	28	30	29	29
Medium	37	39	41	39
High	46	44	48	46

- (a) What is the relationship between the speed of the hair dryer and the height of the balloon from the ground? [1]

- (b) Explain the stated relationship in (a) in terms of energy conversion. [1]

- (c) State the energy conversion while the hair dryer was switched on to keep the balloon suspended in the air. [1]

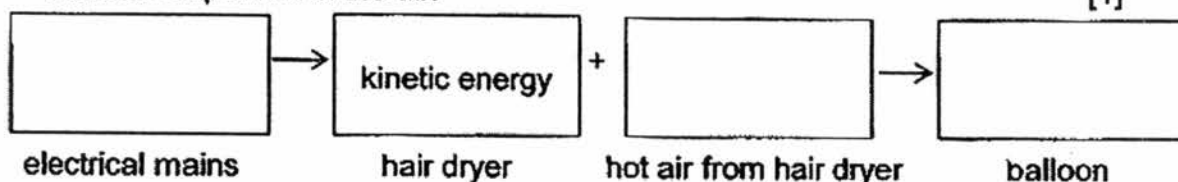

- 44 Neesha conducted an experiment to find out how different types of lubricants would affect the distance moved by the wooden block.

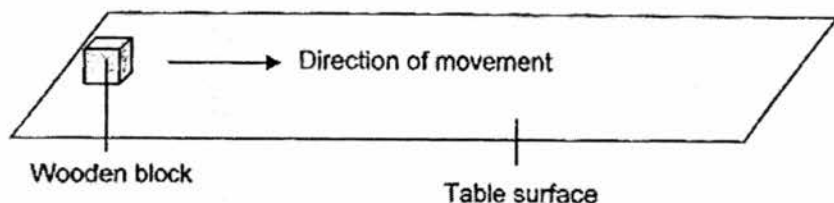

The same amount of lubricants X, Y and Z was applied each time on the table surface shown above. The wooden block was then pushed in the direction indicated by the arrow. The distances moved by the wooden block were recorded in the table below.

Type of lubricants	Distance moved by the wooden block (cm)		
	1 st attempt	2 nd attempt	3 rd attempt
X	32	30	31
Y	45	43	44
Z	27	10	25

- (a) Which of the lubricants, X, Y or Z, is the best? Explain your answer. [1]

- (b) In an accident, a lorry spilled some oil onto the road. Explain why this will be a danger to other drivers travelling on the road. [1]

END OF PAPER

EXAM PAPER 2016

SCHOOL :ROSYTH

SUBJECT :P6 SCIENCE

TERM : SA1

Q1	Q2	Q3	Q4	Q5	Q6	Q7	Q8	Q9	Q10
2	3	4	1	2	4	1	2	3	2
Q11	Q12	Q13	Q14	Q15	Q16	Q17	Q18	Q19	Q20
1	1	3	2	4	2	3	3	2	1
Q21	Q22	Q23	Q24	Q25	Q26	Q27	Q28	Q29	Q30
4	3	2	4	2	4	2	2	3	1

31)a)1)Living things can move by themselves.

2)Living things respond to changes.

b)Birds, as it has a body of feathers and a long beak.

32)a)Yes, as Organism Z has Chloroplast to help to absorb sunlight so as to make food for the plant.

b)Cell wall.

c)There is a nucleus in it, that controls the whole cell and divide to repair the dead or damaged cells.

33)a)To find out how the colour of the filter affects the rate of photosynthesis of the plant.

b)The number of bubbles in the inverted boiling tube.

34)a)mouse-→organism

b)Amount of sunlight /Type of soil.

c)If all the snakes are killed, the mice population would increase and feed on the maize plant so the maize plant population would decrease.

35)a)The organisms will have equal distance to travel to any part of the tray.

b)R , Q, P

36)a)The taller plants also block the smaller plant from sunlight.

b)So that the plant can trap enough sunlight to make food.

c)To avoid the growth of fungi /algae on the surfaces of the leaf in the warm and wet conditions.

37)a)To reduce chances of being spotted by a predator. Long and thin body and legs looks like the branches of tree.

b)Benefit for ants : The ants can eat the sugar the stick insect left for them.

Benefit for stick insect: The stick insect is protected by the army ants especially the eggs.

c)Ants have evacuated the nest before the eggs hatch.

38)a)i)Not ii)F iii)Not iv)T

b)i)Move the torch nearer to the object.

ii)Move the screen further away from the object.

39)a)Gravitational Force, magnetic force and frictional.

b)Dipping the sponges in water. Lubricated the sponges causing less friction allowing the gravitational force to overcome the friction force, hence the result.

40)a)Statement P is incorrect. Plasticine is a solid, hence cannot be compressed. As it's able to be shaped into different shape with exertion of force, statement Q is correct that it has indefinite shape.

b)The air she blew occupied space in the bottle, allowing the water to flow out the bottle into the basin.

41)a)Y, has bigger exposed surface area in contact with beaker of water, hence able to transfer more heat to water in set up B.

b)He can conclude that Container B is the best conductor of heat and A conducts the least heat.

42)a)The water vapour from the people's breath gained heat from the heat, It then condensed as water droplets on the inner cooler surface of the bus's window,

b)More condensation took place and more mist formed to cover the word.

c)The temperature of the air in the bus is the same as the temperature of the window, so no condensation would occur.

43)a)As the speed of the hair dryer increases, the height of the balloon from the ground increases.

b)When the speed of the hair dryer increased, more kinetic energy was transferred to the air which was transferred to the balloon.

c)Electrical energy \rightarrow Kinetic energy + Heat energy \rightarrow Kinetic energy

44)a)Lubricant Y, as it reduces the most friction and allows the block to move the fastest.

b)Oil is a lubricant and reduces Friction on the road. When other cars stop, they skid and might result in an accident.