

Name: \_\_\_\_\_ ( )

Class: Primary 6 \_\_\_\_\_

## CHIJ ST NICHOLAS GIRLS' SCHOOL



**Primary 6**  
**Semestral Assessment 1 – 2017**

**SCIENCE**

**BOOKLET A**

**9 May 2017**

**Total Time for Booklets A and B: 1 hour 45 minutes**

**28 questions**  
**56 marks**

**Do not open this booklet until you are told to do so.**  
**Follow all instructions carefully.**  
**Answer all questions.**

**This booklet consists of 22 printed pages.**



**Section A (28 x 2 marks = 56 marks)**

For each question from 1 to 28, four options are given. One of them is the correct answer. Make your choice (1, 2, 3 or 4). Shade the correct oval (1, 2, 3 or 4) on the Optical Answer Sheet provided.

1. Cindy had to classify four animals as shown below.



bat



butterfly



ant



penguin

She classified them with the help of the chart below.

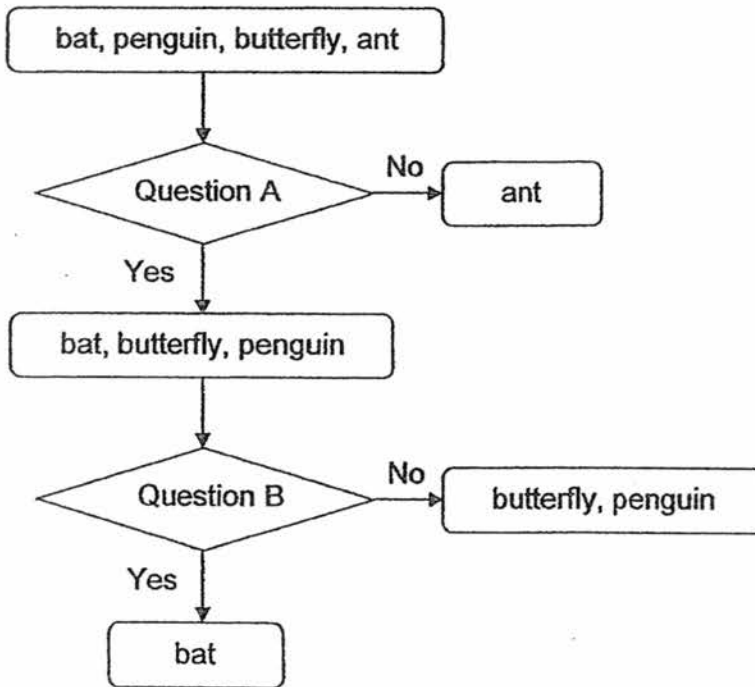

What one of the following correctly represents questions A and B?

	Question A	Question B
(1)	Do they have hair?	Do they have wings?
(2)	Do they have scales?	Do they take care of their young?
(3)	Do they have wings?	Do they give birth to their young alive?
(4)	Do they lay eggs?	Do they have scales?

2. Blood samples were collected from different blood vessels in the body. The following graph shows the amount of oxygen in each of the blood samples.

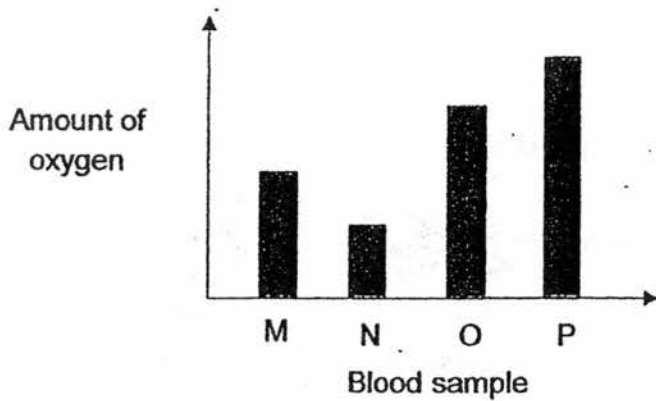

Which one of the blood samples is most likely taken from the blood vessel carrying blood from the heart to the lungs?

- (1) M
- (2) N
- (3) O
- (4) P

3. The diagram below shows a plant cell.

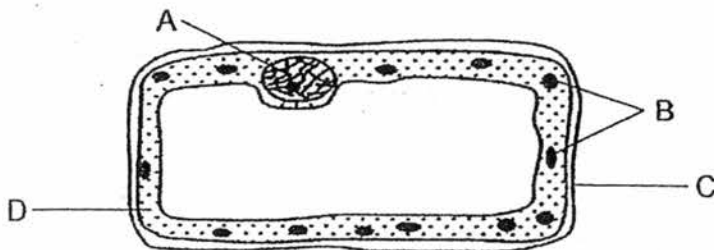

Which parts of the cell A, B, C or D, are also found in an animal cell?

- (1) A and B only
- (2) A and D only
- (3) B and C only
- (4) C and D only

4. Jackson made some observations of three different garden plants X, Y and Z.

Plant	Observations
X	Flowers are bright yellow. Animal R and S were seen flying around the plant.
Y	Flowers have huge petals. Animal S were found around the plant.
Z	Animal R were found around the plant.

Animal R and S are agents of pollination.

Animal S has a good vision but poor sense of smell.

Animal R has a good sense of smell and unable to see yellow objects.

Based on the information above, what can Jackson conclude about X, Y and Z?

- A Flowers on Y are sweet-smelling.
- B Flowers on X are sweet-smelling.
- C Flowers on Z are yellow and odourless.

- (1) B only
- (2) C only
- (3) A and B only
- (4) B and C only

5. The diagram below shows a plot of land at the start and end of the year. C, D and E, represent different types of plants.

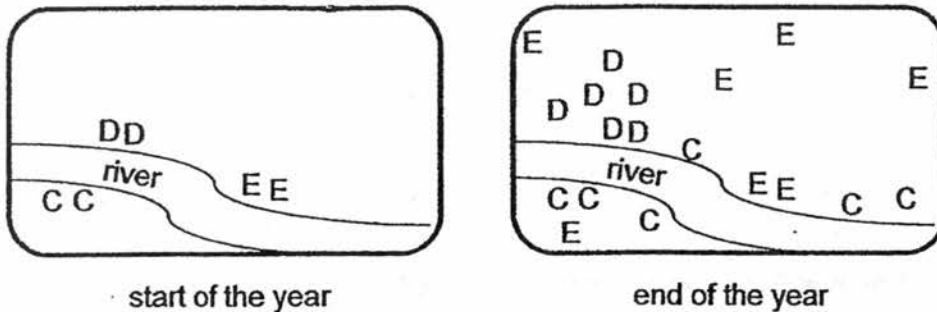

Based on the diagram, which one of the following shows the most likely method of dispersal of fruits C, D and E?

Dispersal method			
	Animal	Water	Splitting
(1)	C	E	D
(2)	E	D	C
(3)	D	E	C
(4)	E	C	D

6. The diagram below shows the reproductive organs of a human.

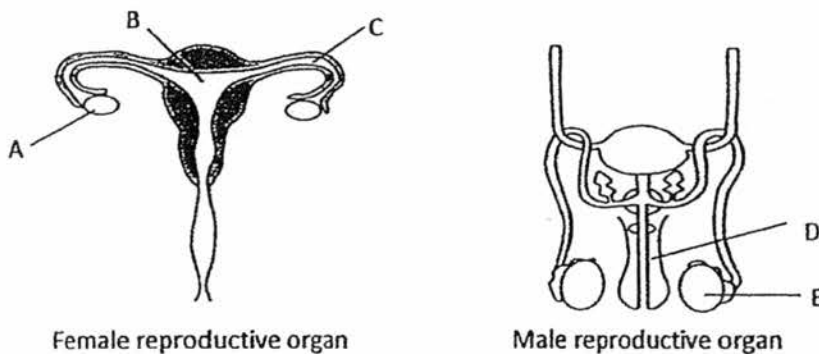

Which one of the following shows the correct functions of the male and female reproductive organs?

	Female reproductive sex cell is produced	Male reproductive sex cell is produced
(1)	A	E
(2)	B	D
(3)	A	D
(4)	C	E

7. Hamid conducted an experiment to investigate the factors affecting the rate of photosynthesis on two similar plants. Plant A was given more carbon dioxide than plant B. The results of his experiment are shown in the graph below.

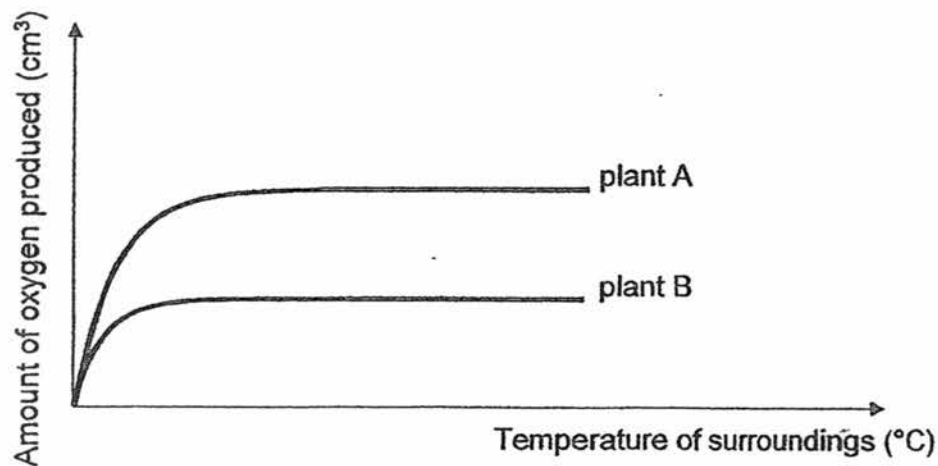

From Hamid's results, he can conclude that the rate of photosynthesis is affected by the \_\_\_\_\_.

- A amount of oxygen present
  - B temperature of the surroundings
  - C amount of carbon dioxide present
  - D amount of water given to the plant
- (1) A and B only  
(2) A and D only  
(3) B and C only  
(4) C and D only

8. Five similar plants were exposed to different conditions as shown in the table below. A tick (✓) indicates the presence of the condition.

Conditions	Set-ups				
	1	2	3	4	5
Presence of carbon dioxide	✓	✓	✓	✓	✓
Presence of oxygen	✓	✓			✓
Presence of sunlight		✓	✓	✓	✓
50 ml of water	✓	✓	✓		
10 ml of fertiliser		✓		✓	✓

Which two set-ups should be chosen to find out if water is needed for photosynthesis?

- (1) Set-ups 1 and 2
  - (2) Set-ups 1 and 3
  - (3) Set-ups 2 and 5
  - (4) Set-ups 4 and 5
9. Which of the following statements are true about mushrooms and mould?
- A They only grow in soil.
  - B They reproduce from spores.
  - C They are able to make their own food.
  - D They break down dead matter into simpler substances.
- (1) A and C only
  - (2) A and D only
  - (3) B and C only
  - (4) B and D only



10. Yusoff carried out a project to study more about the rotting log and the leaf litter community.

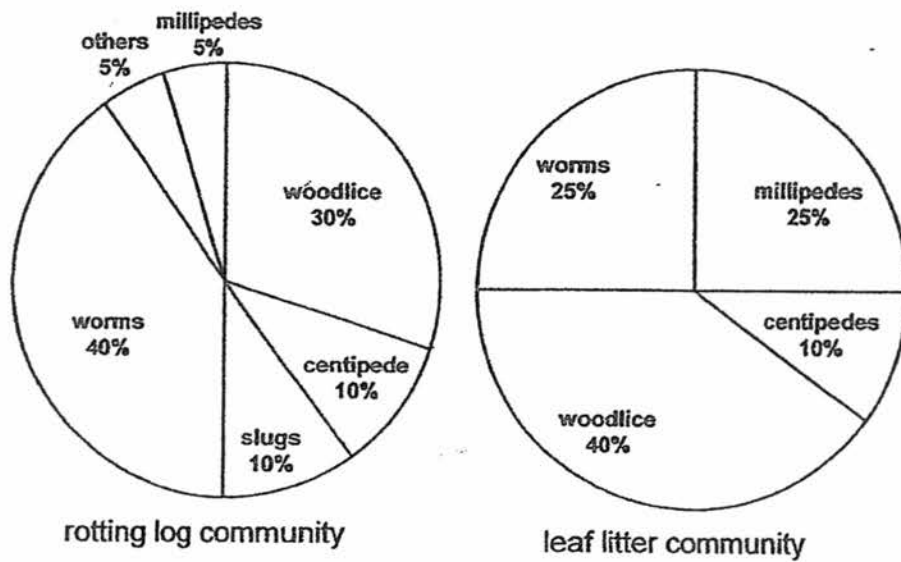

Based on the information in the pie charts above, which of the following statements is/are correct?

- A There are more worms in the rotting log community.
  - B There are six populations in the rotting log community.
  - C The number of centipedes in both communities is the same.
  - D There are more types of organisms in the rotting log community.
- (1) D only  
(2) A and C only  
(3) B and D only  
(4) A, B and C only

11. Jane wanted to find out which pond is the most suitable for guppies to survive in. Equal amount of water samples from ponds X, Y and Z are poured into beakers A, B and C respectively.

Which variables should be kept constant for a fair test?

- A The type of pond water
- B The amount of water in each beaker.
- C The amount of food given to the guppies
- D The number of guppies at the end of the experiment
- E The number of guppies at the start of the experiment

- (1) A, B and C only
- (2) B, C and E only
- (3) B, C, D and E only
- (4) A, B, C, D and E

12. The following graph shows the effect of temperature on the population size of three different organisms X, Y and Z over a period of time.

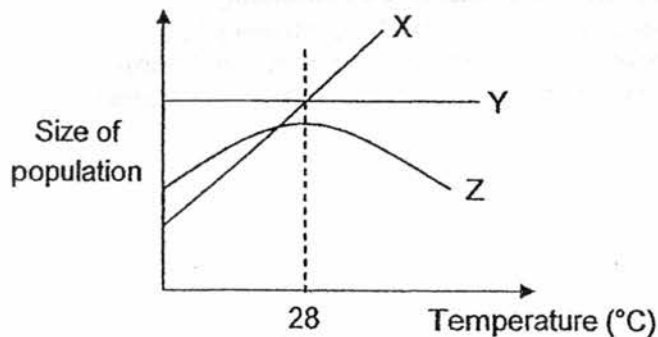

Which one of the following statement is false?

- (1) Organism Z grows best at 28°C.
- (2) Organism Y is able to survive as the temperature changes.
- (3) The population size of X increases as the temperature increases.
- (4) The population size of Z increases as the temperature increases.

13. The number of plants and animals in the school pond were counted and represented in the bar graph below.

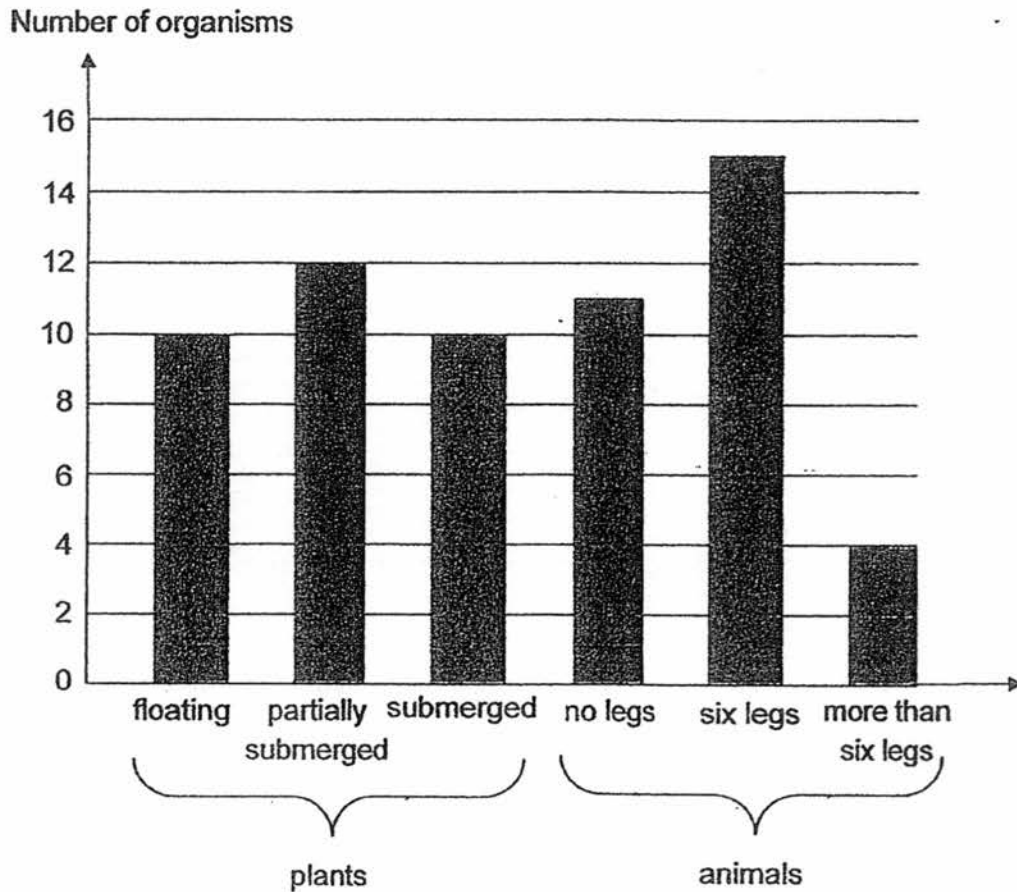

Which of the following statements about the plants and the animals in the pond are definitely correct?

- A There is at least 6 populations of plants and animals.
- B The plant population is more than the animal population.
- C There are a total of 62 populations of plants and animals.
- D The number of floating plants and submerged plants are equal.

- (1) A and B only
- (2) A and D only
- (3) B and C only
- (4) C and D only

14. The diagram below shows a food web.

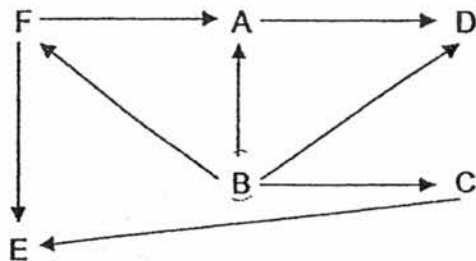

Which of the following is correctly represented by A, B, C, D, E and F in the food web?

	Plant	Plant eater only	Animal eater only	Plant and animal eater
(1)	B	C and F	E	A and D
(2)	B	A, C and D	E	F
(3)	E	F	B	A, C and D
(4)	E	C and F	A and B	D

15. The diagram below shows how decomposers act on dead matter and change them into simple substances.

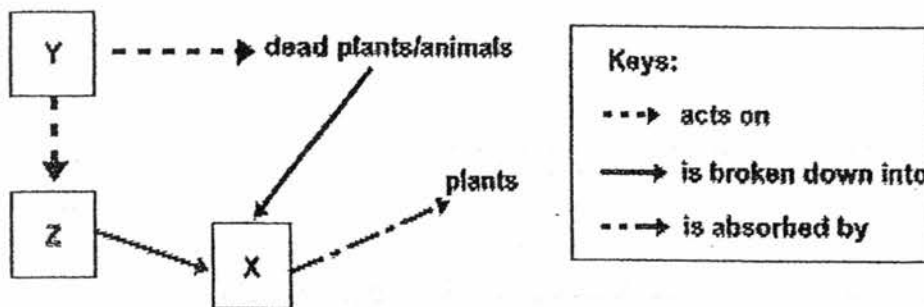

Which one of the following best represents X, Y and Z respectively?

	X	Y	Z
(1)	carbon dioxide	predators	nutrients
(2)	water	fungi	nutrients
(3)	mineral salts	prey	animal waste
(4)	mineral salts	bacteria	animal waste

16. Emily was given a beaker containing three powdery substances X, Y and Z, mixed together. The properties of the three substances are given in the table below.

	Property A	Property B	Property C	Property D
	Does it dissolve in water?	Does it float on water?	Is it a magnetic material?	Is it a good conductor of electricity?
Substance X	no	yes	no	no
Substance Y	no	no	yes	yes
Substance Z	no	no	no	yes

Which properties A, B, C and D, should Emily make use of in order to separate the three substances?

- (1) A and B only
  - (2) A and D only
  - (3) B and C only
  - (4) C and D only
17. The table below shows the freezing points and boiling points of three substances X, Y and Z.

Substance	Freezing point (°C)	Boiling point (°C)
X	5	100
Y	20	78
Z	115	130

Based on the information given above, which one of the following is correct?

- (1) X is a solid at 9 °C.
- (2) X and Y are both liquids at 26 °C.
- (3) Y and Z are both solids at 110 °C.
- (4) Z can be a liquid or a gas at 115 °C.

18. Study the diagram shown below. Different objects are fixed inside the hollow tubes.

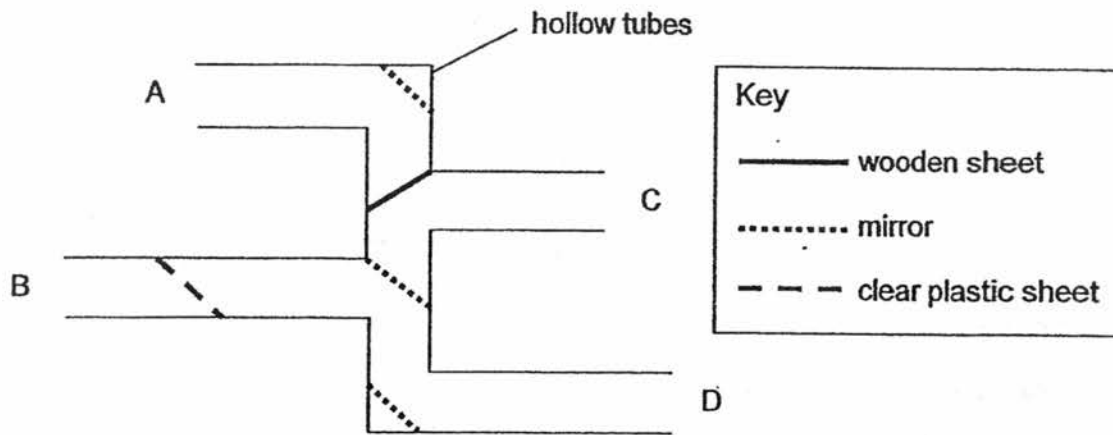

Where should the position of the eye and object be in order to see the object through the tubes?

	Position of object	Position of eye
(1)	A	C
(2)	B	D
(3)	C	B
(4)	D	A

19. Study the circuit below carefully. When one of the bulbs in the circuit fuses, the other three bulbs remain lit.

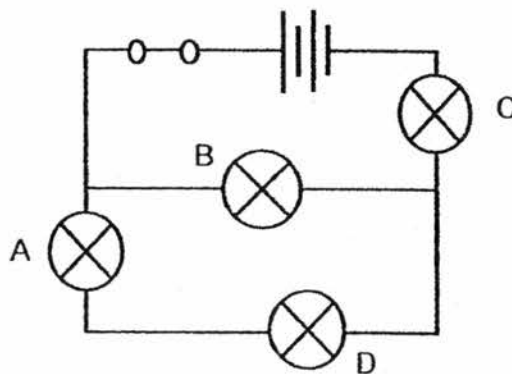

Which one of the following bulbs has fused?

- (1) A
- (2) B
- (3) C
- (4) D

20. Two steel cans were filled with boiling water as shown below. Can B was wrapped with wool for a duration of 30 minutes. The temperature of the water in each can was recorded every minute.

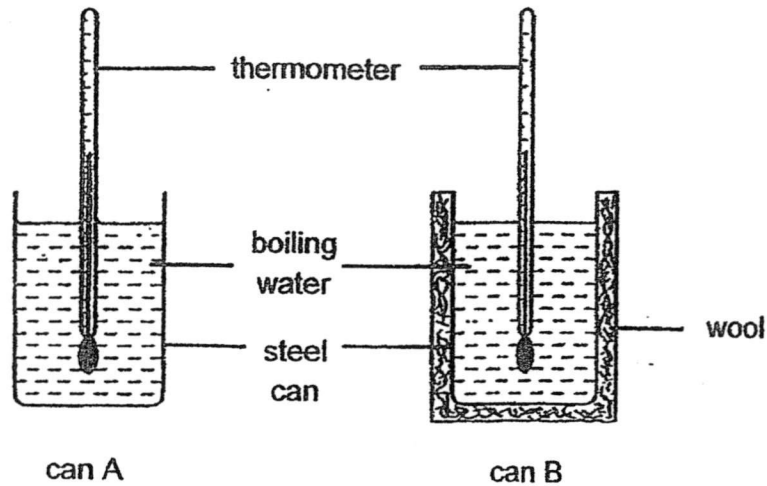

Which one of the following graphs shows the results obtained?

(1)

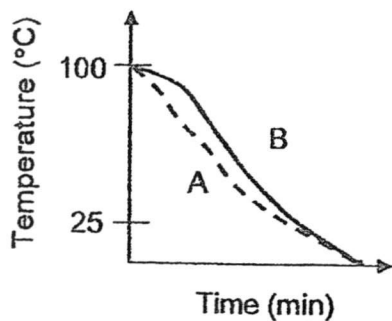

(2)

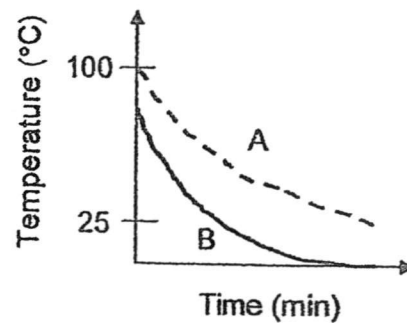

(3)

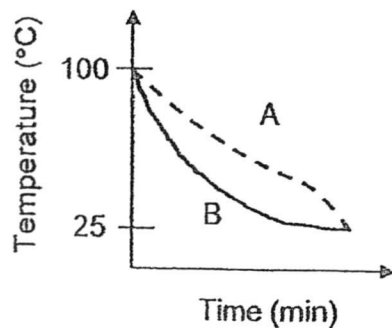

(4)

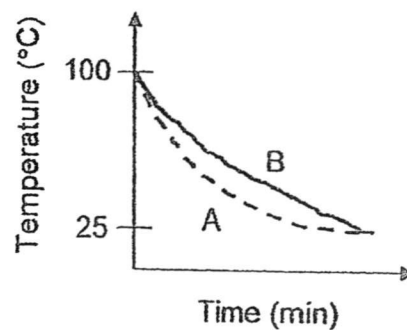

21. Sandra conducted an experiment using the set-up shown below.

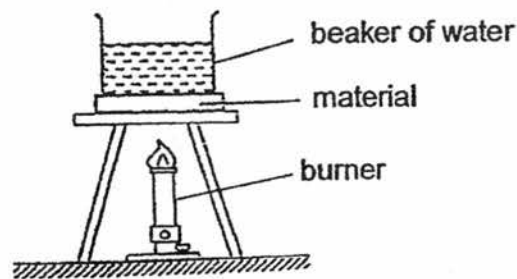

She recorded the time taken for the water to boil when different materials X, Y and Z, were placed below the beaker of water in the table below.

Material	How well the material conducts heat	Time taken for the water to start boiling (min)
X	good	12
Y	very good	12
Z	poor	12

Sandra used different volumes of water for her experiment.

Which one of the following most likely shows the volume of water used at the start of the experiment?

Volume of water used at the start for each material (cm <sup>3</sup> )			
	Material X	Material Y	Material Z
(1)	250	350	150
(2)	150	350	250
(3)	350	250	150
(4)	150	250	350



22. Janice conducted an experiment as shown below. The circuit card had paper clips A, B, C, D, E and F, clipped onto it. Some of these paper clips were connected by electrical wires.

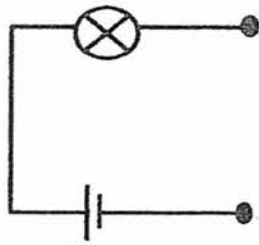

circuit tester

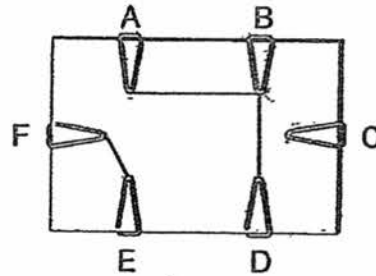

circuit card (back view)

Which pair of paper clips should she connect to the circuit tester in order to light up the bulb?

- (1) A and D
- (2) A and F
- (3) B and C
- (4) C and E

23. Study the chart below.

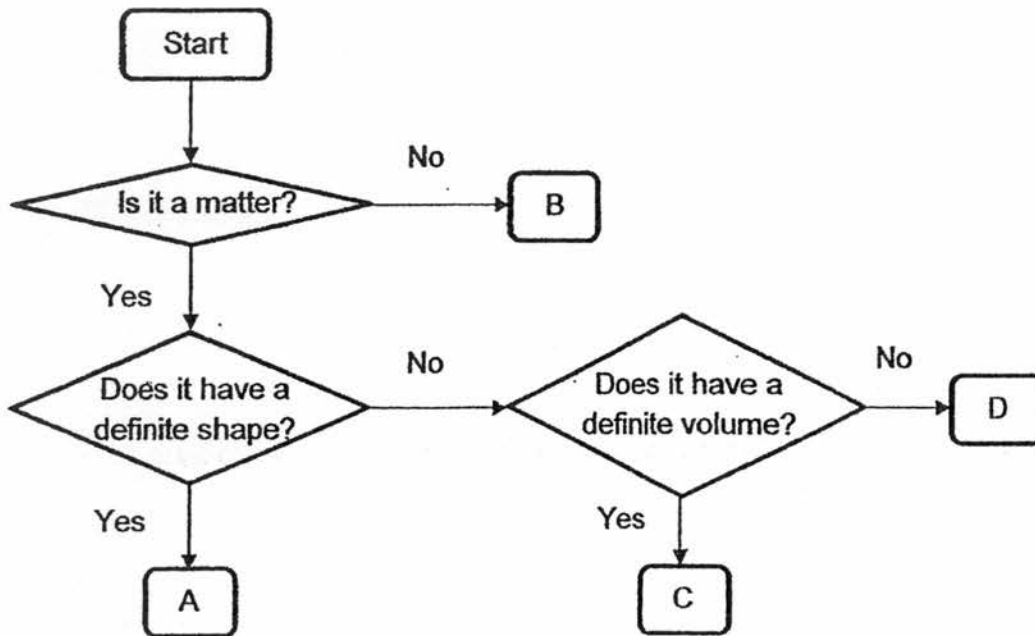

Which of the following is most likely to be A, B, C and D?

	A	B	C	D
(1)	book	sunlight	ruler	oxygen
(2)	sunlight	oxygen	milk	oil
(3)	ruler	shadow	oil	carbon dioxide
(4)	carbon dioxide	book	ice	shadow

24. Kristen wanted to find out if the surrounding temperature affects the rate of evaporation of water.

Set-up	Surrounding temperature (°C)	Strength of wind	Volume of water used (ml)
A	25	breeze	200
B	35	strong wind	150
C	35	breeze	200
D	25	breeze	150
E	25	strong wind	200

Which two set-ups should Kristen use for her experiment?

- (1) A and B
- (2) A and C
- (3) B and D
- (4) C and D

25. Sarah filled three identical beakers X, Y and Z, with the same amount of water of different temperatures. She covered them with metal lids and left them in the same classroom. After ten minutes, water droplets were observed as shown below.

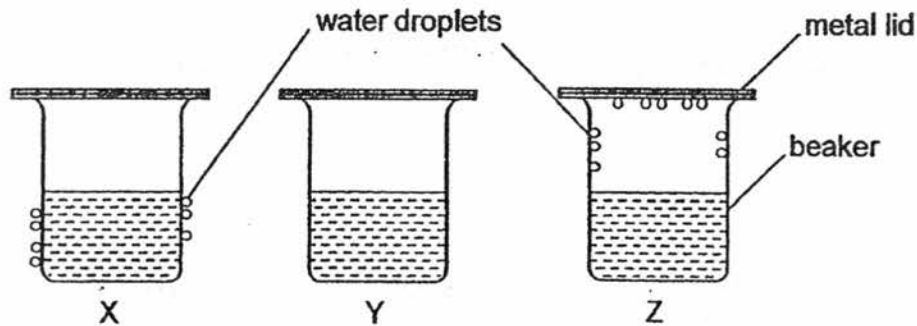

Based on the observations shown above, which of the following statements are true?

- A Only Beaker Z contains hot water.
  - B Beaker X and Y contain cold water.
  - C The water in beaker Y is at room temperature.
  - D Water vapour from the surrounding air lose heat and condense as water droplets on the outer surface of beaker X.
- (1) A and B only  
(2) C and D only  
(3) A, C and D only  
(4) A, B and D only

26. Jason set up an experiment using a ramp made of material W as shown below. He released the ball at position A and recorded the time taken for the ball to reach position B. He then repeated the experiment with ramps made of materials X, Y and Z.

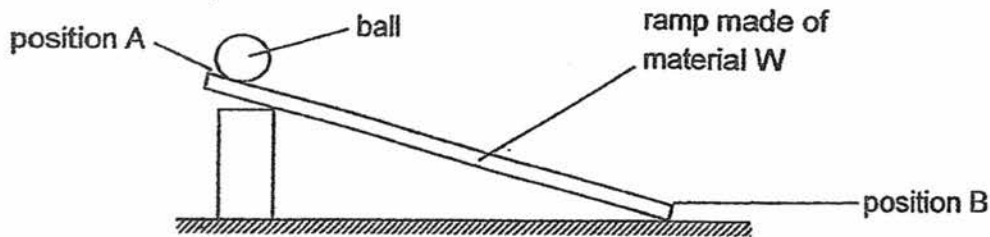

The table below shows the results of the experiment.

Material	Time taken (s)
W	5.0
X	2.4
Y	3.5
Z	1.8

The diagram below shows a round glass bowl lined with material W. Jason released the ball and measured the amount of time taken for the ball to stop rolling. He repeated the experiment below with materials X, Y and Z.

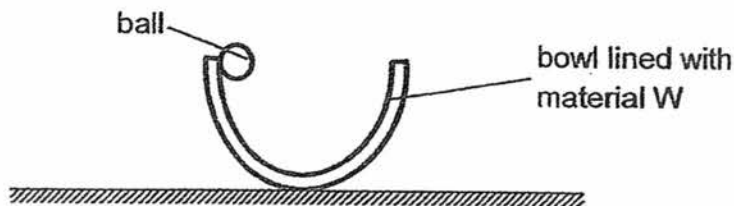

On which material will the ball take the longest time to stop rolling?

- (1) Material W
- (2) Material X
- (3) Material Y
- (4) Material Z

27. The diagram below shows a ball that was released from a certain height.

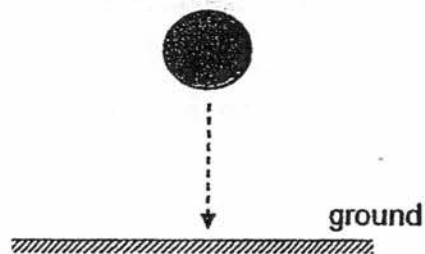

Which one of the following graphs correctly shows the amount of gravitational force acting on the ball as it was released from the height?

(1)

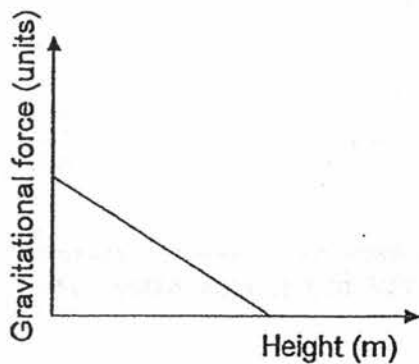

(2)

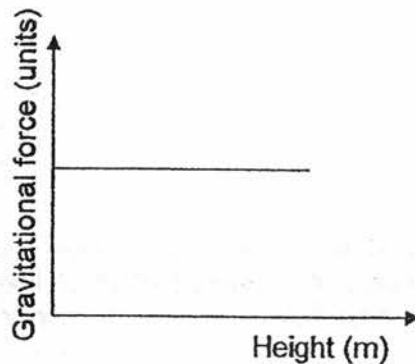

(3)

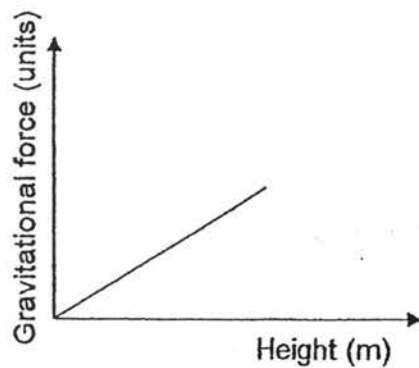

(4)

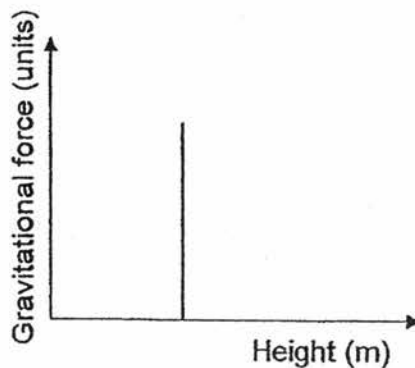

28. Alice conducted an experiment using a spring and some loads. She measured the length of the spring as she increased the mass of the load hung on the spring as shown in the diagram below.

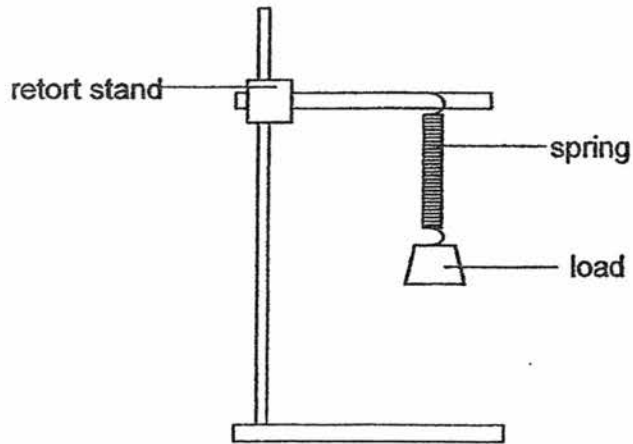

Which one of the following graphs correctly represents Alice's results?

(1)

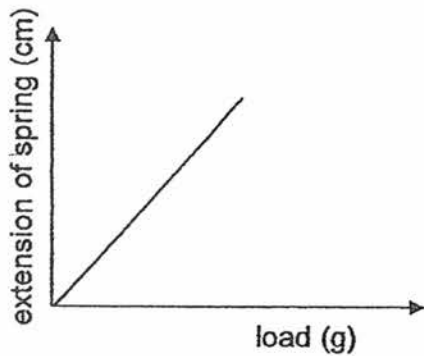

(2)

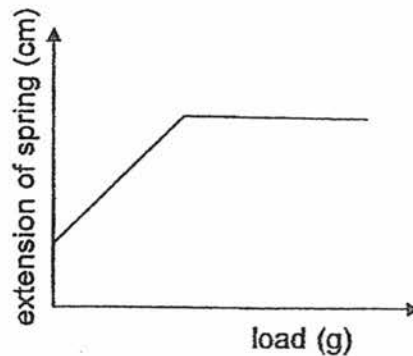

(3)

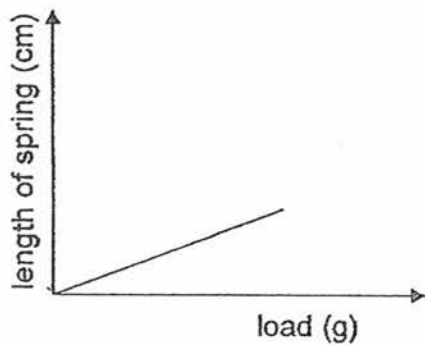

(4)

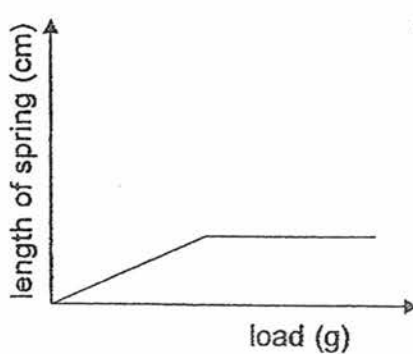

~End of Booklet A~~

Name : \_\_\_\_\_ (    )

Class : Primary 6 \_\_\_\_\_

## CHIJ ST NICHOLAS GIRLS' SCHOOL



### Primary 6 Semestral Assessment 1 – 2017

SCIENCE

BOOKLET B

9 May 2017

Total Time for Booklets A and B: 1 hour 45 minutes

13 questions  
44 marks

Do not open this booklet until you are told to do so.  
Follow all instructions carefully.  
Answer all questions.

This paper consists of 17 printed pages.

Booklet A	56
Booklet B	44
Total	100

\_\_\_\_\_  
Parent's Signature/Date



**Section B (44 marks)**

For questions 29 to 41, write your answers in this booklet.

The number of marks available is shown in the brackets at the end of each question or part question.

29. The table below shows some information on four cells A, B, C and D.  
A tick (✓) indicates the presence of the part of a cell.

Parts of a cell	Cell			
	A	B	C	D
Nucleus	✓	✓	✓	
Cell wall	✓		✓	
Cell membrane	✓	✓	✓	✓
Cytoplasm	✓	✓	✓	✓
Chloroplast	✓			

- (a) Based on the table above, which one of the cells A, B, C or D, cannot reproduce? Explain why.

[1]

---

---

- (b) Jimmy says that since cell C has a cell wall, it is definitely a leaf cell. Do you agree with him? Explain why.

[1]

---

---

---

---

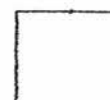

30. An experiment was carried out with three types of wind-dispersed seeds X, Y and Z. 10 seeds of each type were mixed and placed on a table as shown below. The fan was then switched on for 30 seconds.

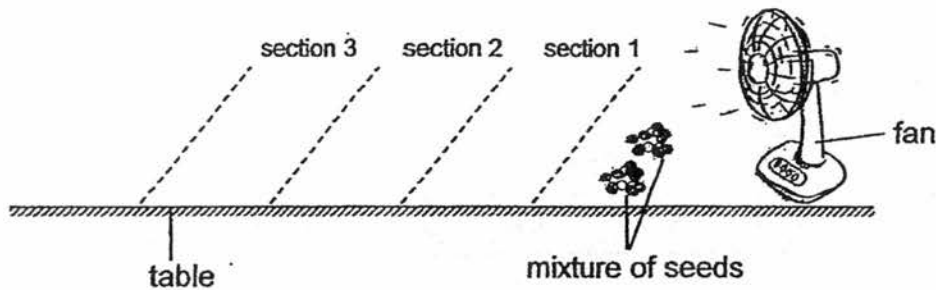

After 30 seconds, the number of seeds of each type was counted in each section and recorded in the table below.

Type of seeds	Average mass of seeds (g)	Number of seeds		
		Section 1	Section 2	Section 3
X	1	0	1	9
Y	1.6	2	8	0
Z	2.1	7	3	0

- (a) Based on the results, what can be concluded about the mass of the seed and the distance travelled? [1]

---



---

- (b) The fan speed was kept constant throughout the experiment. Explain why. [1]

---



---

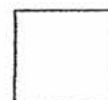

31. Sam observed that plant G has bright and colourful flowers.

- (a) Explain how by having bright and colourful flowers help plant G in reproduction.

[1]

---

---

---

The diagram below shows the fruits of plant G and H. Both fruits are dispersed by animals.

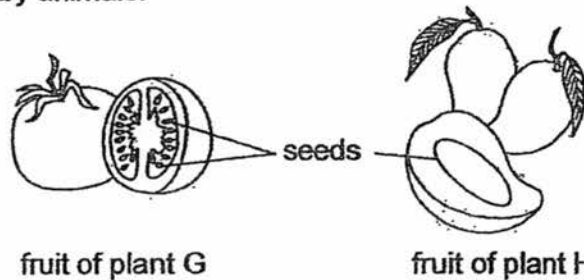

- (b) Based on the diagram above, which fruit could be dispersed further away from its parent plant? Explain your choice.

[2]

---

---

---

---

---

- (c) Why is it an advantage for plants to be able to disperse their seeds further away?

[1]

---

---

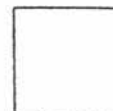

32. Plant X grows well in flooded fields. Siti wanted to find out which type of soil is suitable to grow plant X. She collected three equal amounts of soil A, B and C, and placed them each in a funnel lined with filter paper as shown in the diagram below.

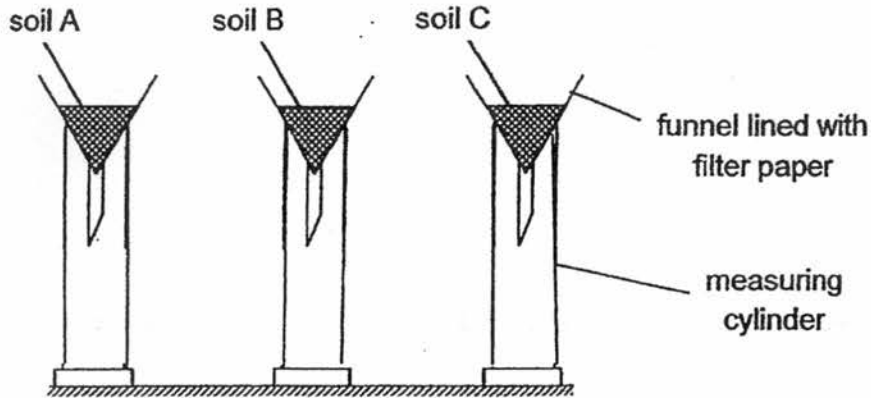

She then poured 200 ml of water into each funnel and measured the time taken to collect 100 ml of water in each of the measuring cylinder. The graph below shows the results of her experiment.

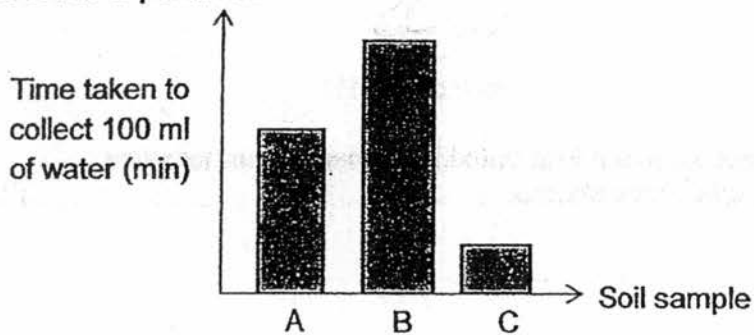

- (a) Based on the above results, which type of soil is the most suitable to grow plant X. Explain your answer. [2]

---



---



---

- (b) Based on the same experiment, what else can Siti measure to reach the same conclusion? [1]

---



---

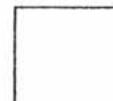

88. Kathy conducted an experiment using four identical tubes as shown.

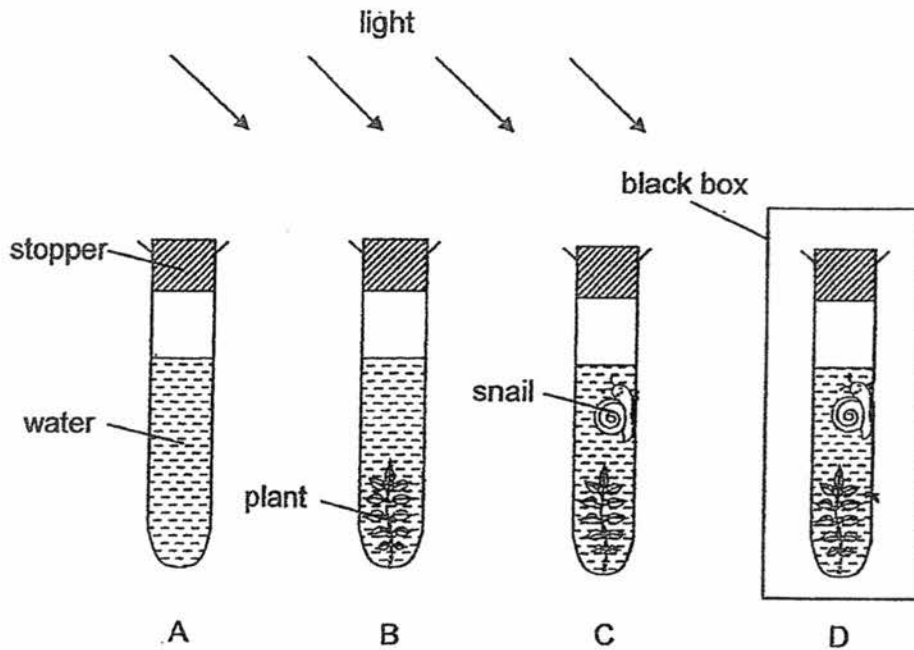

After a few hours, a drop of liquid Q was added to each tube. When liquid Q was added, the colour of water changed according to the amount of carbon dioxide present.

Each number below represents a different colour. The number for the colour of the water in tube A is 4.

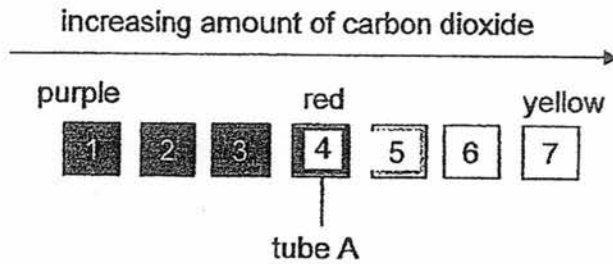

(a) Suggest a number for the colour of the water in tube B. [1]

Tube B: \_\_\_\_\_

Tube D: \_\_\_\_\_

(b) Explain your answer in (a) for tube B. [1]

---



---

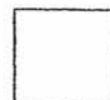

- (c) Kathy predicted that tube C has more carbon dioxide than tube A. However, her friend Sarah said that this may not be true. Explain why tube C may not have more carbon dioxide than tube A. [2]

---

---

---

---

The graph below shows the results for one of the set-ups.

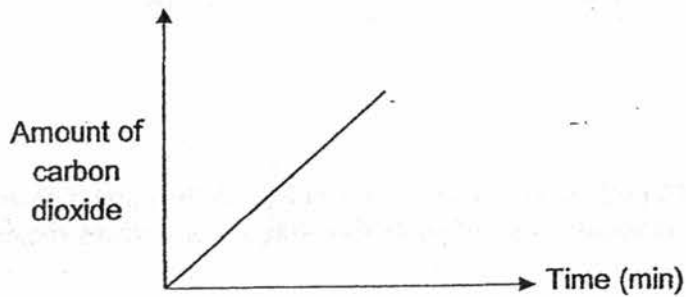

- (d) Which set-up A, B, C or D, could the above graph represent? Explain your answer. [1]

---

---

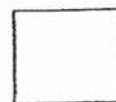

34. Study the food web shown below.

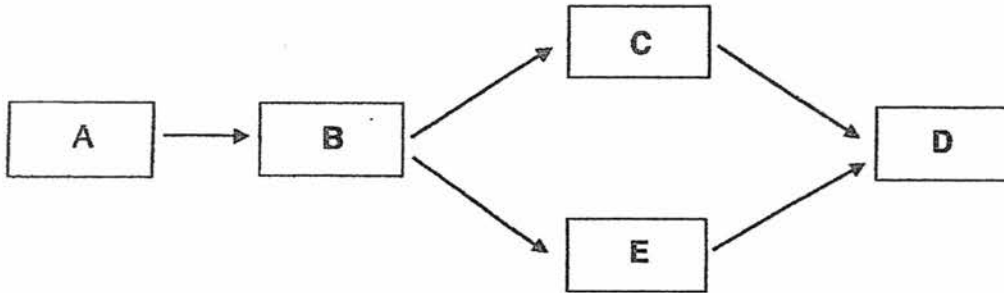

(a) Jane said, "Organism B is a producer." Do you agree with her? Explain why. [1]

---

---

(b) What could be 2 possible direct results of a sudden decrease in the population of C? [1]

---

---

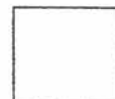

Jane recorded the population size of organism E over a period of time. She then introduced organism W into the food web. Population size of organisms E and W are shown below.

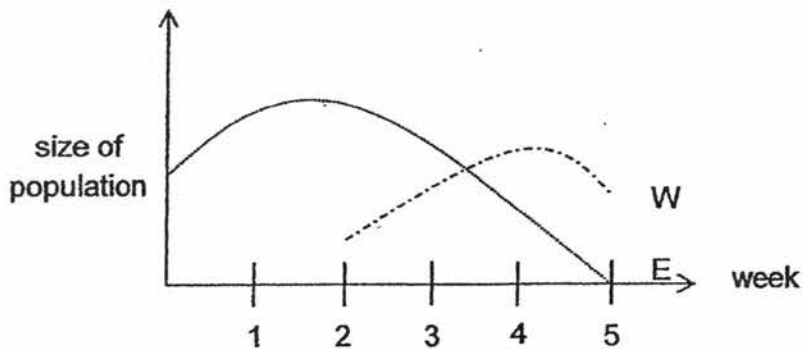

(c) Based on the graph above, describe the food relationship between E and W. [2]

---

---

---

---

---

(d) What happens to the excess energy stored in the organisms if they are not preyed upon by any other organisms? [1]

---

---

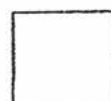



35. Celine conducted an experiment using similar bulbs and batteries as shown below. The light sensors are used to measure the brightness of the bulbs in set-ups X and Y.

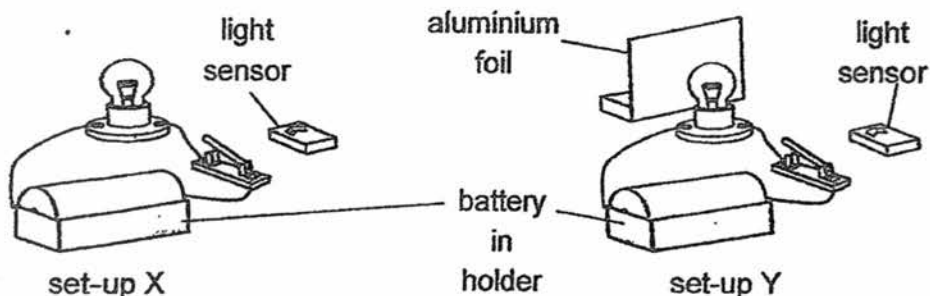

Her results are shown in the graph below.

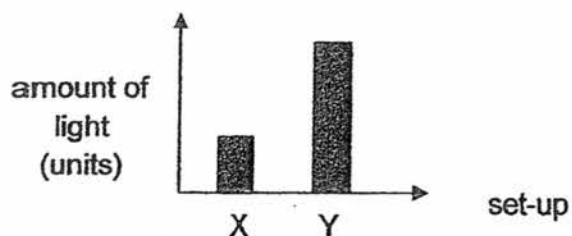

- (a) Explain why the light sensor in set-up Y gave a higher reading. [1]

---

---

- (b) Celine conducted her experiment in a dark room. Explain how this condition ensures that a fair test is carried out. [1]

---

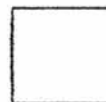

The diagram below shows a high visibility vest used by construction workers who work during night time.

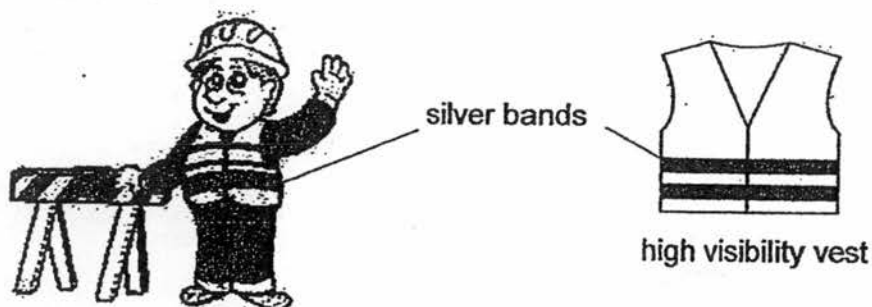

- (c) How do the silver bands on the vest ensure the safety of the construction workers when they work on the road at night? [1]

---

---

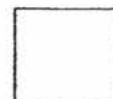

36. The diagram below shows an electric iron.

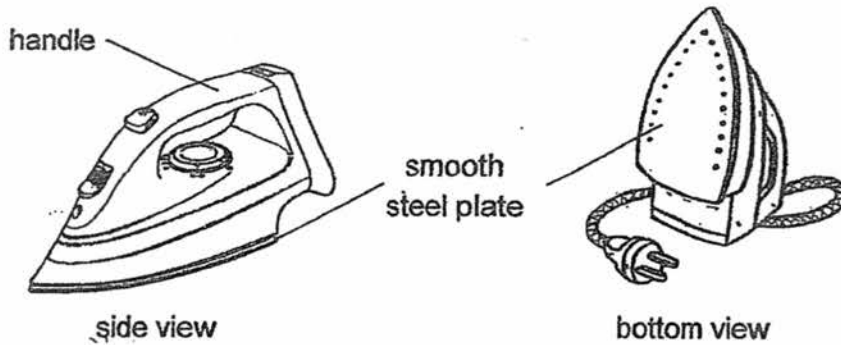

(a) Give a reason why the steel plate at the bottom of the electric iron needs to be smooth. [1]

---



---

(b) Suggest a material the handle could be made of. Give a reason for your answer. [1]

---



---

The diagram below shows two designs of heating elements X and Y, made from the same material. They are attached to the base of two similar electric irons before being covered with smooth steel plates.

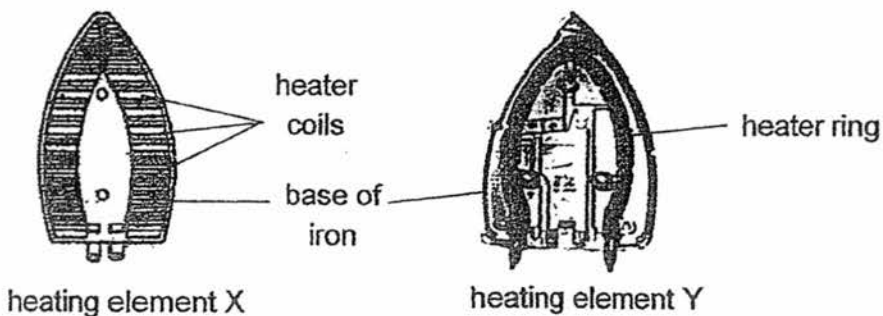

(c) Which heating element X or Y, will heat up the electric iron more quickly? Explain your answer. [2]

---

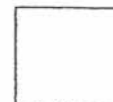

37. The diagram below shows a water tank used for flushing a toilet bowl.

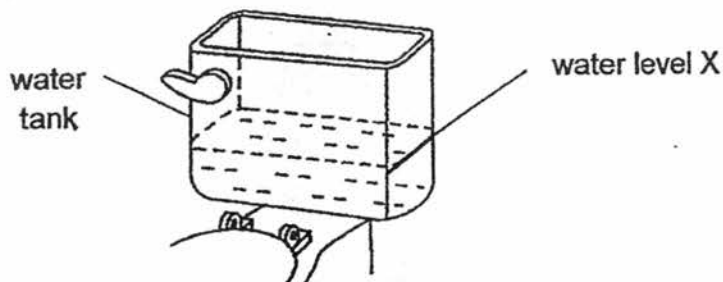

After flushing, water enters and re-fills the tank. The tank will stop filling when the water reaches level X.

Alex wanted to use lesser water to flush the toilet bowl. He decided to put a sealed plastic bottle filled completely with pebbles into the water tank.

- (a) Explain how his method would help reduce the amount of water used to flush the toilet bowl. [2]

---

---

---

---

- (b) State a property of matter that is shown in the above experiment. [1]

---

---

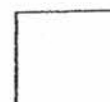

38. Timmy carried out an experiment using four batteries, wires and some similar bulbs. He then plotted the results of his experiment in the graph shown below.

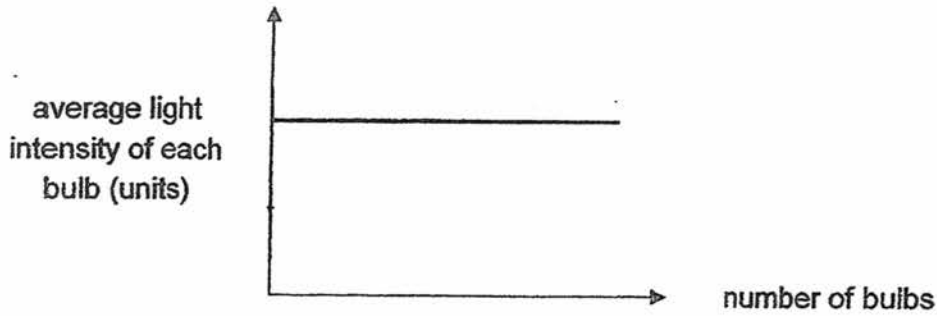

(a) From the graph, state the relationship between the number of bulbs and the average light intensity of each bulb. [1]

---

---

(b) Based on the graph, what can be concluded about the arrangement of bulbs in the experiment? [1]

---

---

(c) Timmy repeated the experiment with two batteries. In the graph above, draw the line graph to represent the results that he would obtain. [1]

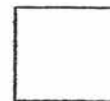

39. Bala conducted an experiment with set-ups X and Y to investigate the evaporation of water. He hung two similar wet towels in the same location under the sun. In set-up X, the towel was folded once while in set-up Y, the towel was folded twice.

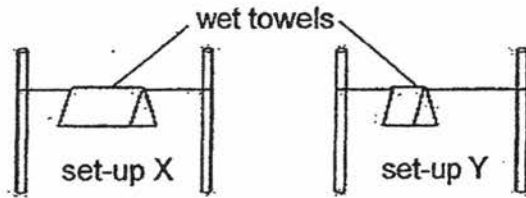

- (a) What is the aim of his experiment? [1]

---



---

- (b) Based on the results of the experiment, label the axis in the graph below. [1]

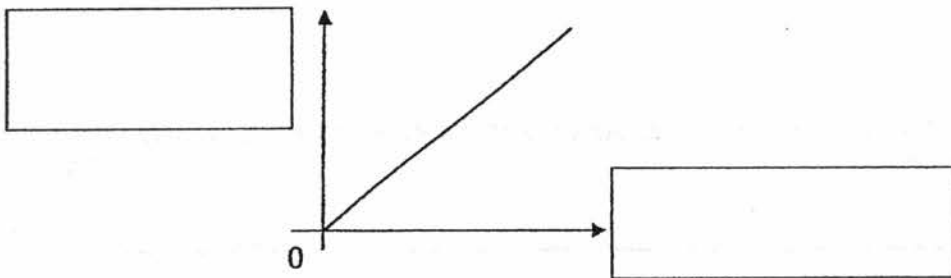

The graph below shows the rate of evaporation of water of two similar pieces of wet cloths.

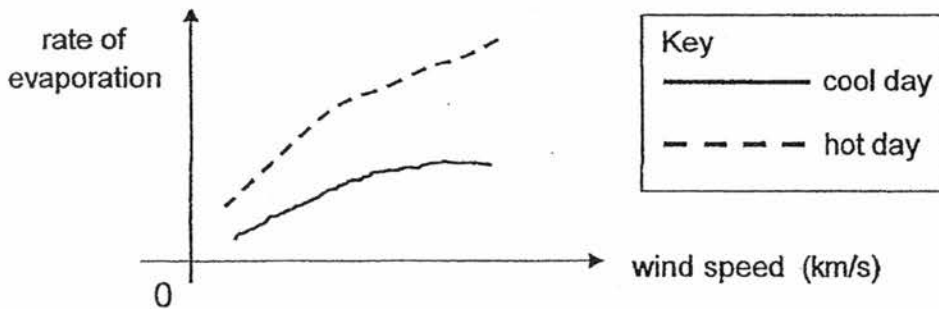

- (c) Based on the graph above, state two conditions that can increase the rate of evaporation of water. [2]

(i) \_\_\_\_\_

(ii) \_\_\_\_\_

40. Jacob wanted to find out how the distance travelled by the marble was affected by the length of the stretched elastic band of the catapult as shown in the diagram below.

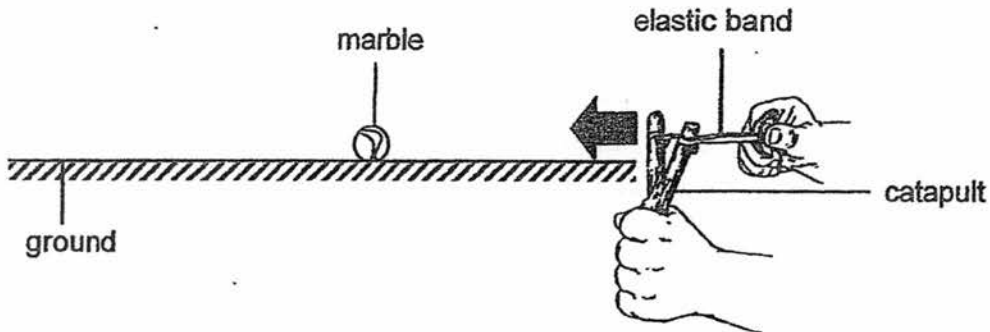

The table below shows the results of Jacob's experiment.

Length of stretched elastic band (cm)	Distance travelled by the marble (m)
5	1
10	3
15	6

- (a) What is the main energy conversion from stretching the elastic band with the hand till the marble started moving. [1]

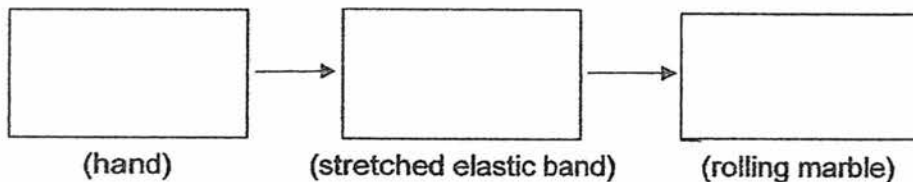

- (b) Based on Jacob's results, how did the length of the stretched elastic band affect the distance travelled by the marble? Explain why. [2]

---



---



---



---

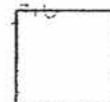

41. The set-up below shows how a mixture of iron filings and sand could be separated when placed on a moving belt.

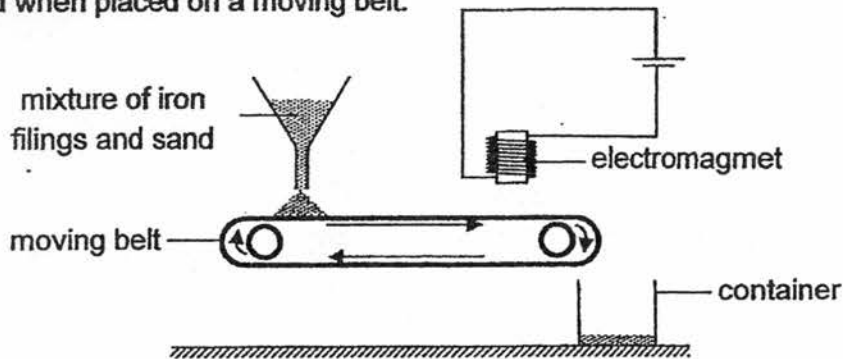

- (a) What would be collected in the container? Explain your answer. [1]

---



---

Iron blocks of different sizes are placed on the moving belt as shown in the diagram below.

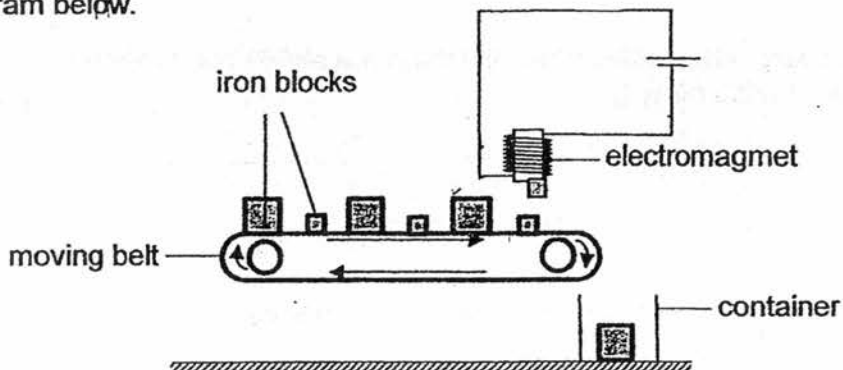

- (b) Only the bigger blocks are collected in the container. Explain why. [1]

---



---

- (c) The set-up can collect 10 blocks in a minute when the belt is moving at its maximum speed. Suggest a way to collect more than 10 blocks in a minute without changing the speed of the belt. [1]

---



---

~~End of Booklet B~~

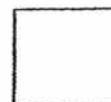



**EXAM PAPER 2017**      **9 May 2017**  
**LEVEL : PRIMARY 6**  
**SCHOOL : CHIJ ST NICHOLAS GIRL'S SCHOOL (PRIMARY)**  
**SUBJECT : SCIENCE**  
**TERM : SEMESTRAL ASSESSMENT 1**

Q1	Q2	Q3	Q4	Q5	Q6	Q7	Q8	Q9	Q10
3	2	2	1	4	1	3	3	4	1
Q11	Q12	Q13	Q14	Q15	Q16	Q17	Q18	Q19	Q20
2	4	2	1	4	3	2	2	2	4
Q21	Q22	Q23	Q24	Q25	Q26	Q27	Q28		
1	1	3	2	3	4	2	1		

**Q29a) Cell D. It does not have a nucleus so genetic information cannot be passed down from the next generation.**

**b) No. I do not agree. Not only leaf cells has a cell wall, cell C could be from a root cell, as all cells from the plant have cell walls. Cell C also does not have chloroplast, which is needed in leaf cells to carry out photosynthesis to make food for the plant.**

**Q30a) As the mass of the seed increases, the distance travelled decreases.**

**b) So that the result of the distance travelled by the seeds is solely due to its mass, volume and fan speed.**

**Q31a) Flower attracts pollinators to pollinate the flower so fertilization can occur.**

**b) The seed of G are smaller and can be swallowed by animals and digested seeds are passed out as waste when the animal travels to another place far away.**

**c) H prevents overcrowding so there is less competition between the young plant and the parent plant for sunlight, nutrients, water and space.**

**Q32a) Soil B. Plant X grows well in soil which allows water to seep in the slowest, and soil B takes the longest time for water to seep through, indicating it is similar to the soil plant X grows the best in.**

**b) She can measure the amount of water collected in the morning cylinder over a set duration of time.**

**Q33a) Tube B: 1      Tube D: 7**

**b) In tube B, the plant takes in all the carbon dioxide in the water, photosynthesizes as it also has sunlight and gives out the most amount of oxygen, leaving very little amount of carbon dioxide left.**

c) The rate of photosynthesis of the plant is faster than the rate of evaporation of the snail and the plants so more carbon dioxide is used.

d) Set-up D. Set-up D is inside a box and the plant in D does not receive sunlight, and is unable to photosynthesize and produce oxygen, instead, it respire and gives out carbon dioxide. With the carbon dioxide from the plant and from the snail when it exhales, and the carbon dioxide would increase.

Q34a) I do not agree with her. Organism B feeds on A, and producers only produce food instead of consuming other organism like B does.

b) Organism B will increase and D will decrease.

c) E is the prey of W and W is the predator of E because when W was introduced to the food web, E decreases as W eats E.

d) When the organisms die, decomposers break down their dead body into simpler substances which is returned to the soil as nutrients.

Q35a) In set up Y, the sensor can sense the light given off from the bulb and the light from the bulb reflected off the aluminum foil, compared to set-up X is sensor which senses the light given off from the bulb.

b) So that only light detected is from the bulb and not any other light source.

c) The silver band reflects light from the cans highlights and the street lamps into the drivers eyes and it allows the drivers to see the workers and avoid hitting them.

Q36a) Smooth metal reduces friction between the iron and the cloth so that it is easier to iron the cloth.

b) Plastic. It must be a poor conductor of heat so that the user's hand would not be burned if they use a good conductor of heat.

c) Heating element X as it has greater surface area in contact to the steel plates so the steel plate would heat up faster.

Q37a) Plastic bottle with pebbles takes up space inside the so there will be less water needed to fill up to level X so reducing the amount of water used.

b) Water occupies space.

Q38a) As the number of bulbs increases, the average light intensity of each bulb remains the same.

b) The bulbs are formed in a parallel circuit.

c)

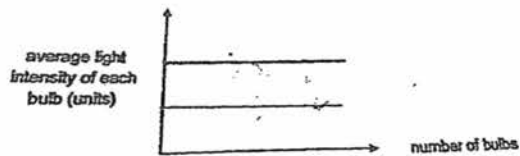

**Q39a) To find out if the amount of exposed surface area affects the rate of evaporation.**

**b) Rate of evaporation (left)      Exposed surface area (right)**

**c)(i) The greater amount of wind      (ii) Higher temperature**

**Q40a) Kinetic energy → Potential elastic energy → Kinetic energy**

**b) The longer the stretched elastic band, the longer the distance travelled by the marble as the band has more elastical potential energy tube converted to more kinetic energy in the marble.**

**Q41a) Sand is a non-magnetic material and will not be attracted by the electromagnet.**

**b) Gravitational force acting on the bigger block is greater than the magnetic force at the electromagnet.**

**c) Put the blocks closer to each other.**

3

END

