



RAFFLES GIRLS' PRIMARY SCHOOL

PRELIMINARY EXAMINATION

2010

Your score out of 100	Class	Level
Highest score		
Average score		
Parent's signature		

Name : _____ Index No: _____ Class: P 6 _____
 26 August 2010 **SCIENCE** Att: 1h 45min

SECTION A (30 X 2 marks)

For each question from 1 to 30, four options are given. One of them is the correct answer. Make your choice (1, 2, 3 or 4). Shade the correct oval on the Optical Answer Sheet (OAS) provided.

- 1 Which of the following statements is/are true about ferns, mushroom and mould?
- A They are decomposers.
 - B They need to grow in soil.
 - C They reproduce from spores.
 - D They are able to photosynthesise.

- (1) C only
- (2) A and B only
- (3) B and D only
- (4) A, C and D only

- 2 The table below shows the characteristics of plants W, X, Y and Z. A tick (✓) in the box indicates the characteristic of the plant.

Plant	W	X	Y	Z
Characteristic				
It bears fruit.	✓		✓	✓
It grows on land.		✓	✓	

Based on the information above, which one of the following shows the correct classification of the plants W, X, Y and Z?

	plants			
	flowering	land	non-flowering	land
(1)	W	Y and Z		X
(2)		X	W	Y and Z
(3)	Z	X	W	Y
(4)	W and Z	Y		X

- 3 The table below describes the stages in the life cycles of four animals, P, Q, R and S.
A tick (✓) in the box indicates that the animal fits the description given.

Description	Animal P	Animal Q	Animal R	Animal S
Its young resembles the adult.	✓		✓	
There are three stages in its life cycle.	✓	✓		
Its young goes through moulting.		✓		✓

Which one of the following animals is likely to be a butterfly?

- (1) Animal P
(2) Animal Q
(3) Animal R
(4) Animal S

- 4 The diagram below shows the different phases in the life cycle of a frog. Each phase is represented by the letters A, B, C, D, E and F.

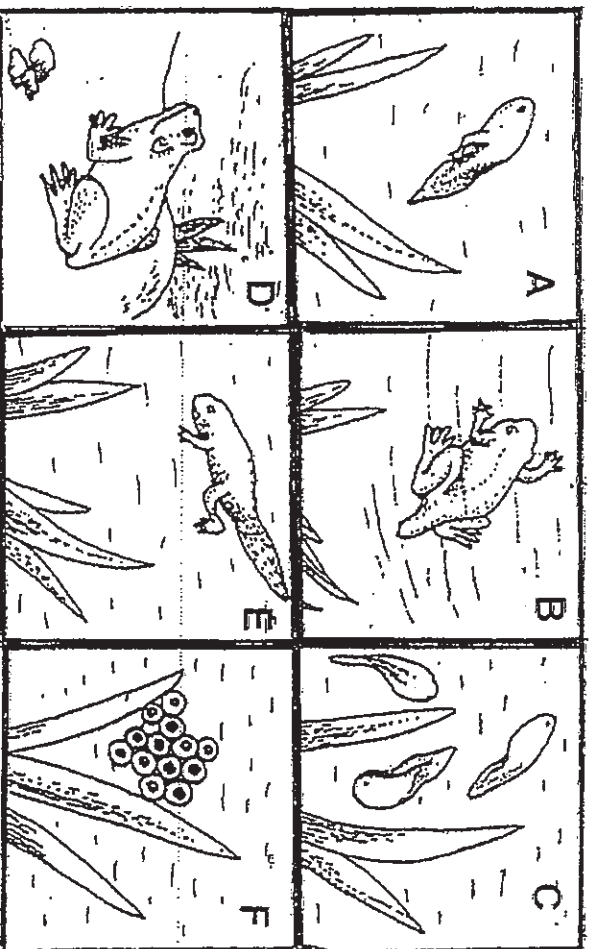

Which one of the following arrangements shows the correct sequence in the development of the frog?

- (1) F, A, E, C, D, B
(2) F, C, A, E, B, D
(3) F, C, A, B, E, D
(4) F, E, A, C, D, B

- 5 The diagrams below show the human reproductive systems.

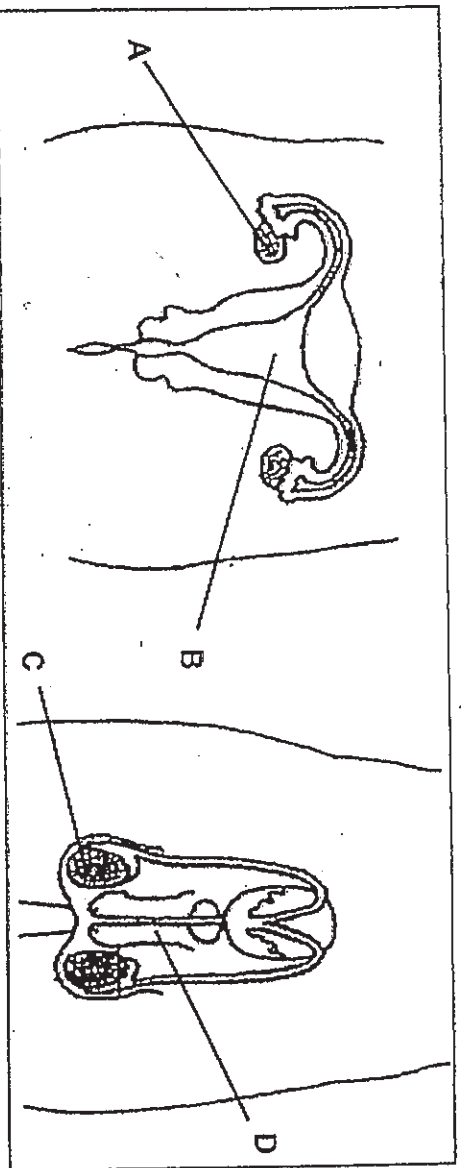

Which parts of the reproductive systems produce cells that can be fused together to develop into a baby?

- (1) A and C
- (2) A and D
- (3) B and C
- (4) B and D

- 6 The diagrams below show two seeds / fruits, A and B.

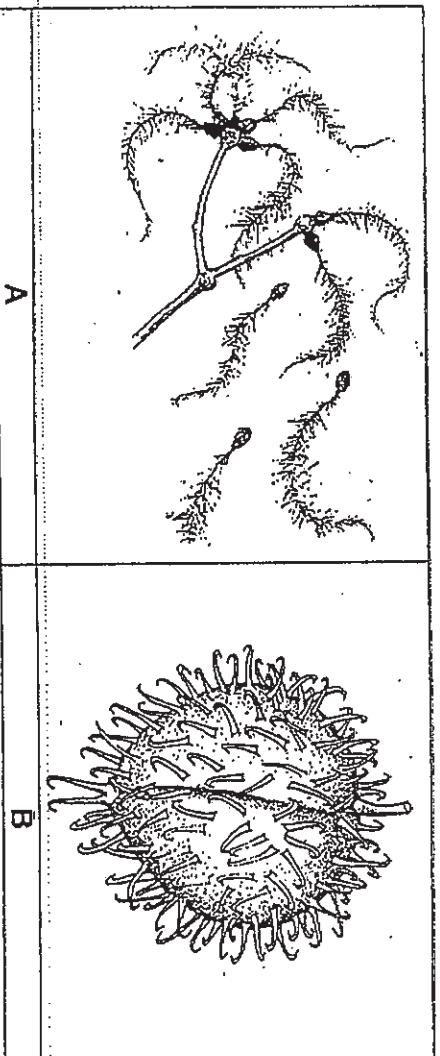

Based on the diagrams, which one of the following shows a correct match of the method of dispersal of the seeds / fruits to its characteristic?

	seed / fruit	method of dispersal	characteristic of seed / fruit
(1)	A	by wind	has feathery structures
(2)	B	by wind	has a wing-like structure
(3)	A	by splitting	has hooks
(4)	B	by animals	is fleshy and juicy

7 The diagrams show the fruits/seeds of three species of plants, X, Y and Z.

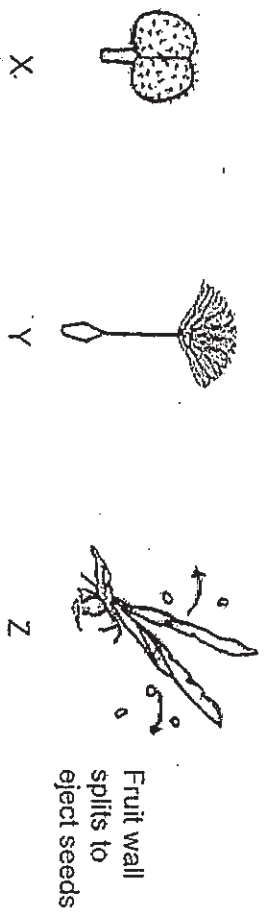

The following diagrams, P, Q, R, show the positions of the parent plants and their respective seedlings over an area of 1km².

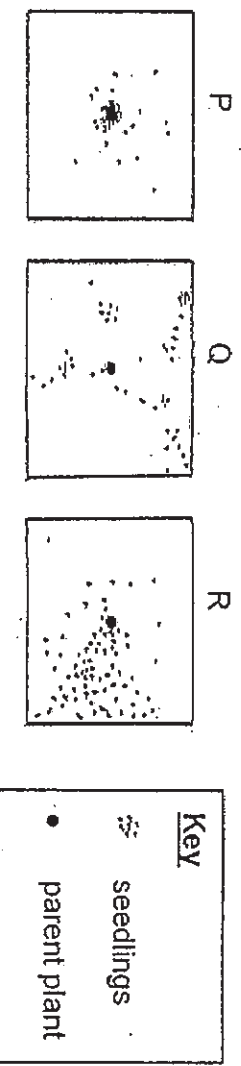

Which one of the following represents the positions of the parent plants and their respective seedlings correctly?

	X	Y	Z
(1)	P	Q	R
(2)	P	R	Q
(3)	Q	R	P
(4)	R	Q	P

8

The diagrams below show the stages in the germination of 2 different types of seeds, X and Y.

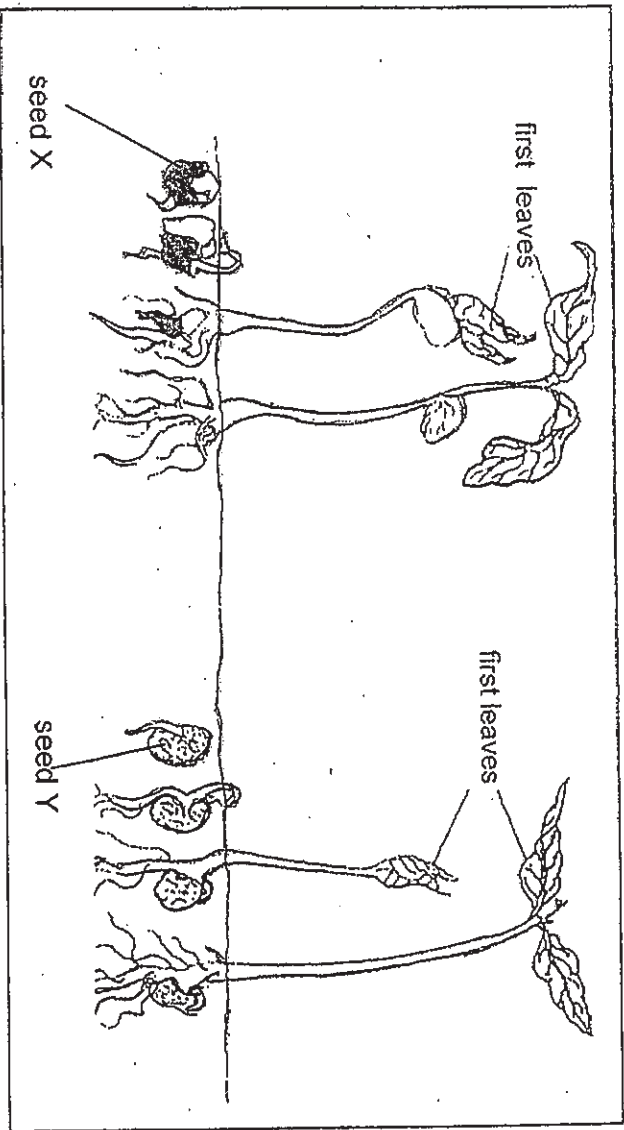

Which of the following statements is/are true about the germination of these seeds?

- A The roots appear before the shoots.
- B Only the seed leaves of X emerge above the ground when its first leaves appear.
- C There is no change in the size of the seed leaves as the seedlings develop.

- (1) B only
- (2) C only
- (3) A and B only
- (4) A, B and C

- 9 Four blood samples W, X, Y and Z were taken from different blood vessels in the body.

The following graph shows the amount of carbon dioxide present in each of these blood samples.

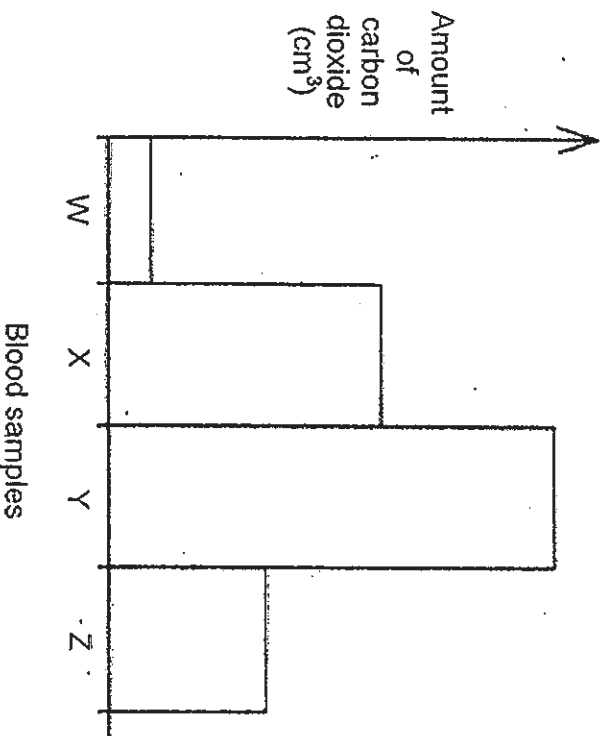

Which blood sample was most probably taken from the blood vessel carrying blood from the heart to the lungs?

- (1) W
- (2) X
- (3) Y
- (4) Z

- 10 The diagram below shows parts of the digestive system of a human.

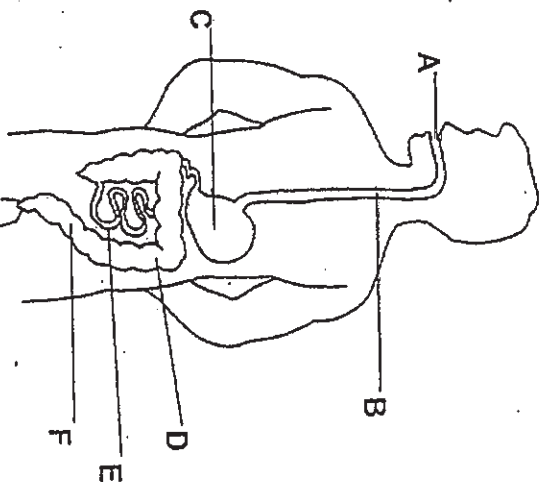

Which one of the following shows the correct pathway in which food travels through the digestive system before it enters the blood stream?

- (1) A → B → C → D
- (2) A → B → C → E
- (3) A → B → C → D → E
- (4) A → B → C → E → D

11 Julia observed some cells using a microscope. The cells are shown in the diagram below.

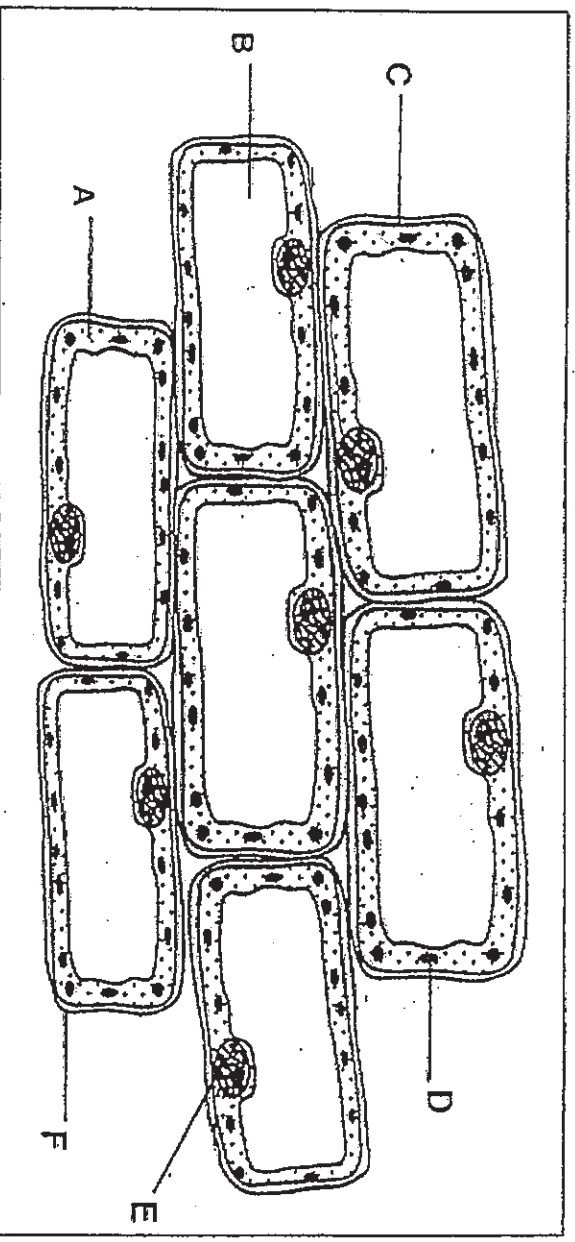

Different parts of the cell are labelled A, B, C, D, E and F.

Which one of the following identifies the parts of the cells correctly?

	where light energy is trapped	controls the entry of substances into the cell	can also be found in animal cells
(1)	A	F	A, C, F
(2)	B	C	B, D, E
(3)	D	C	A, C, E
(4)	D	F	B, E, F

- 12 All conducted an experiment to find out if the addition of fertiliser affects the growth of plant Q.

He used two identical pots, X and Y, for his experiment. Pot Y was set up as a control. The variables for his experiment are shown in the table below.

Pot	Amount of fertiliser (g)	Number of plant Q in pot	Number of times the plants were watered per day
X	15	6	2
Y	A	B	C

Which one of the following gives the most suitable set of values for All to conduct a fair test?

	A	B	C
(1)	0	2	3
(2)	0	6	2
(3)	15	1	2
(4)	15	6	1

- 13 The graph below shows the effect of temperature on the populations of four different organisms, A, B, C and D.

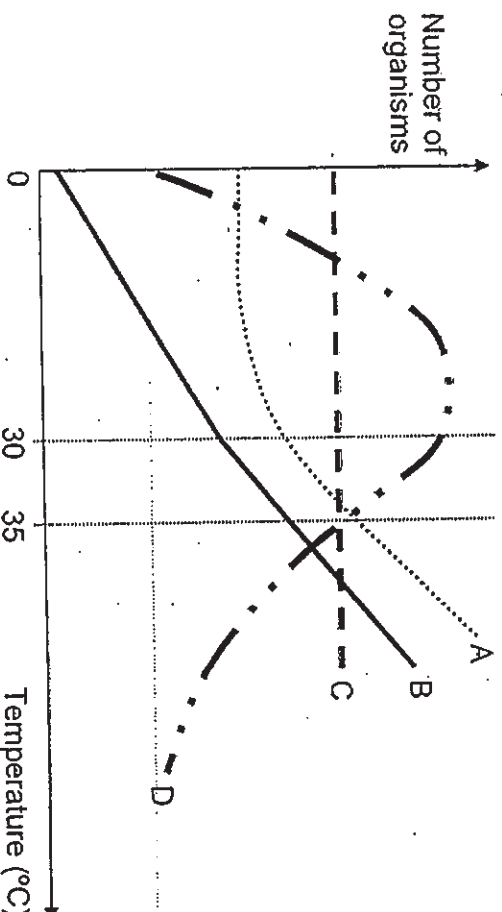

Which of these organisms will continue to thrive when the temperature of the environment is between 30°C to 35°C?

- (1) A and B only
 (2) C and D only
 (3) A, B and C only
 (4) A, B, C and D

- 14 There were some organisms in Pond P, Q and R. James introduced 60 fish of type X into each pond, P, Q and R. He counted the number of fish that was still alive in each pond over a period of 6 days.

The graph below shows the changes in the population of fish of type X in pond P, Q and R.

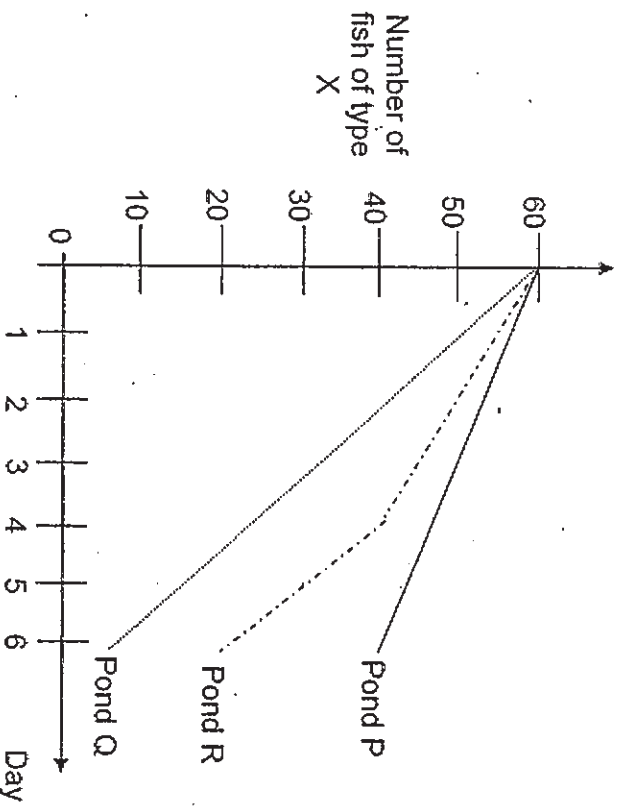

What possible conclusion(s) could James make about the three ponds?

- A Pond P had the most number of fish of type X on day 6.
- B Pond R had more predators of fish of type X than Pond Q.
- C Ponds P and R had fewer fish of type X than Pond Q on day 3.
- D Pond Q had more prey than Pond P for the fish of type X to feed on.

- (1) A only
- (2) A and D only
- (3) B and C only
- (4) B, C and D only

15 The picture below shows a river flowing downstream towards the sea.

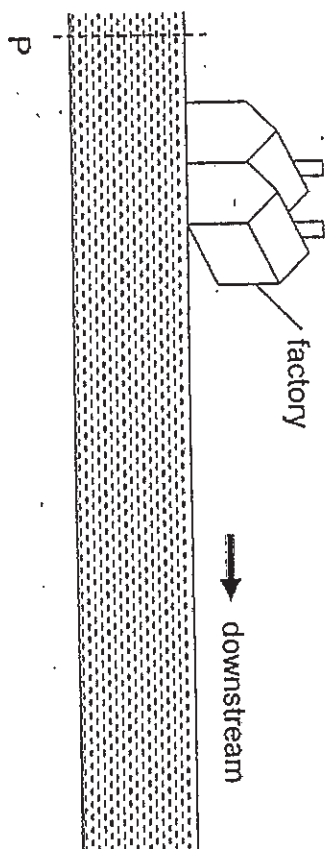

Situated near the river is a factory which is suspected to be a source of water pollution that causes a particular type of fish to die.

Water samples are collected at various points in the river starting from point P.

The graphs below show the oxygen level present in the river at various points in the river starting from point P and how the oxygen level in the river can affect the population size of the fish and the bacteria.

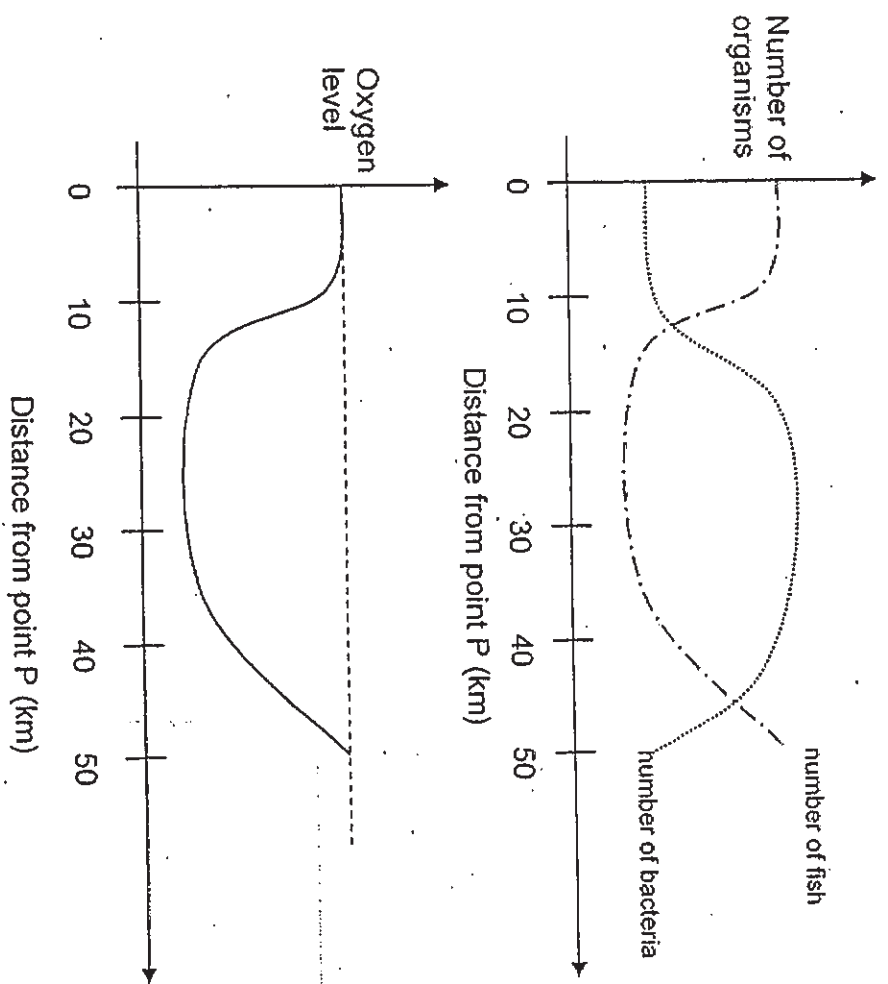

Based on the graphs, which of the following is/are true?

- A The river became polluted only after 20 km.
- B The oxygen level in the river was returned to its original level at 50 km.
- C Pollution caused the number of bacteria to increase, hence reducing the oxygen level in the river.



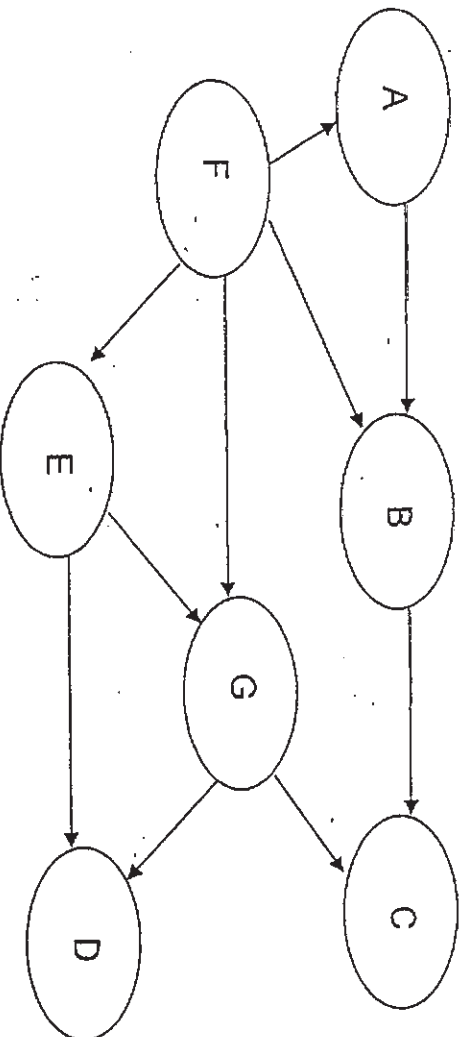

- (1) A only
- (2) C only
- (3) B and C only
- (4) A, B and C



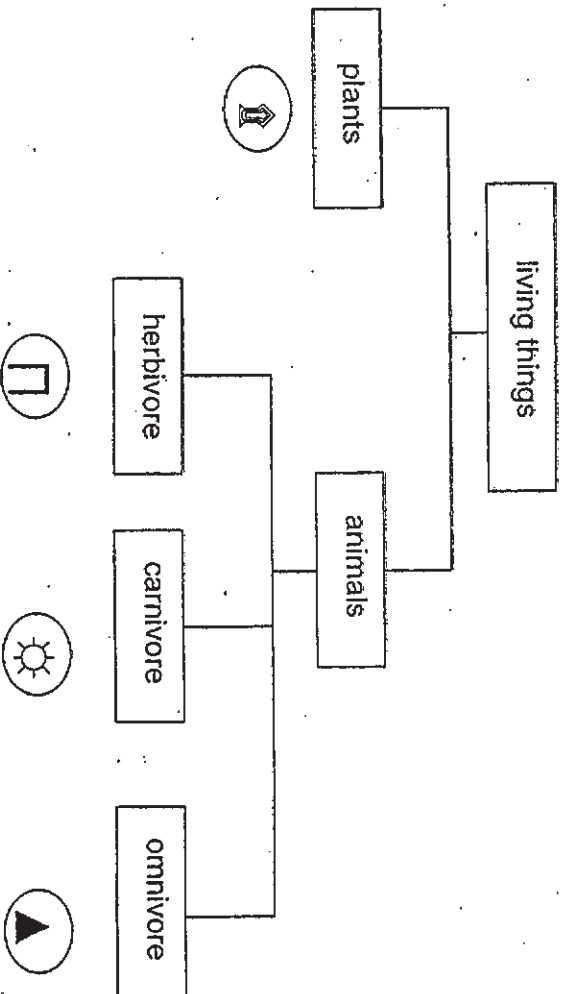

16 The food web shows the food relationships among 7 organisms, A, B, C, D, E, F and G.



Based on the information above, organisms A, B, C, D, E, F and G are classified as shown below.



Which one of the following identifies the organisms for each of these symbols; , , , and , correctly?

				
(1)	A	E	D	B
(2)	E	B	C	G
(3)	F	A	D	C
(4)	F	E	C	G

- 17 The diagram below shows a food web involving 5 organisms, A, B, C, D and E.

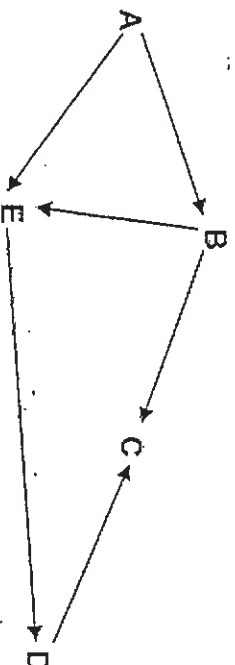

Which of these organisms is/are both a prey and a predator?

- (1) D only
- (2) D and E only
- (3) A, C and D only
- (4) B, D and E only

- 18 Wenwu set up an experiment to demonstrate how light affects the rate of photosynthesis of plants. He prepared set-ups A and B as shown below.

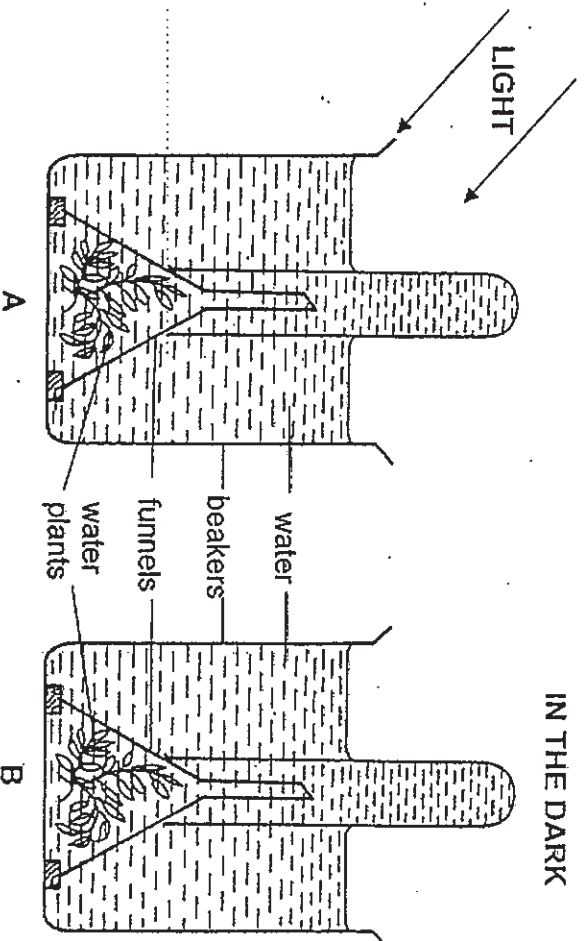

Which one of the following should Wenwu do to obtain his results?

- (1) Add more water plants to set-up B
- (2) Place set-up A in the cupboard for two days
- (3) Measure the temperature of water in both set-ups
- (4) Compare the remaining water left in the test tubes after two days

19

Some pupils in Mrs Wong's class came up with the following sketched design for their camping tent which included a 'window', B.

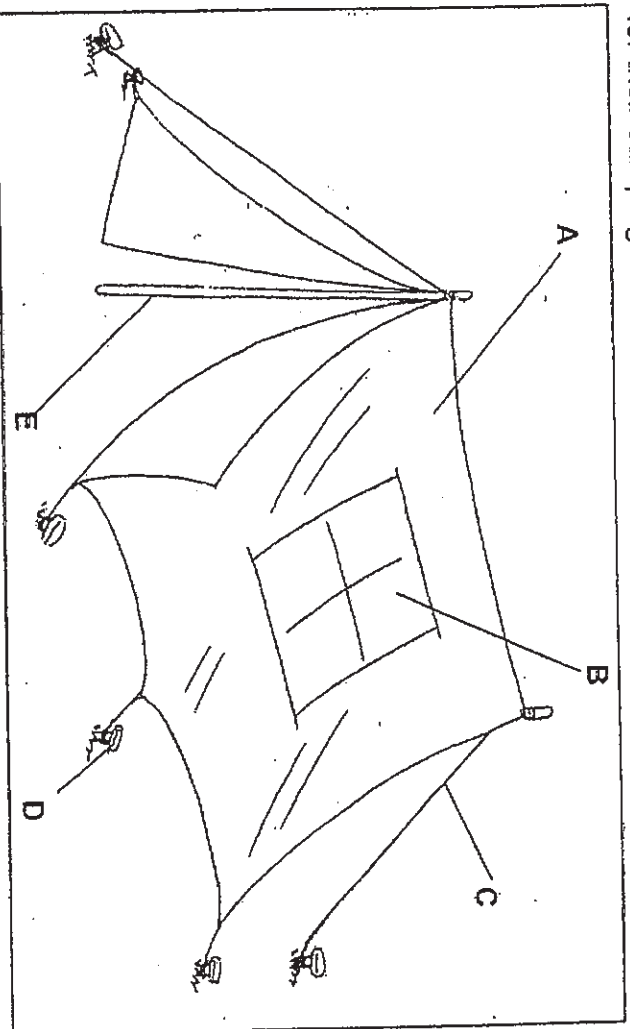

They chose these five different materials based on their properties indicated in the table below.

material	properties
P	<ul style="list-style-type: none"> • waterproof • transparent
Q	<ul style="list-style-type: none"> • hard • durable • does not rust
R	<ul style="list-style-type: none"> • waterproof • is not transparent
S	<ul style="list-style-type: none"> • strong • flexible
T	<ul style="list-style-type: none"> • hard • strong

Which one of the following shows the best material used for each labelled part of the tent?

	A	B	C	D	E
(1)	P	R	Q	S	T
(2)	Q	P	R	T	S
(3)	R	P	S	T	Q
(4)	S	Q	P	R	T

- 20 Two identical syringes were fitted to a container with a capacity of 150 cm^3 as shown in the diagram below.

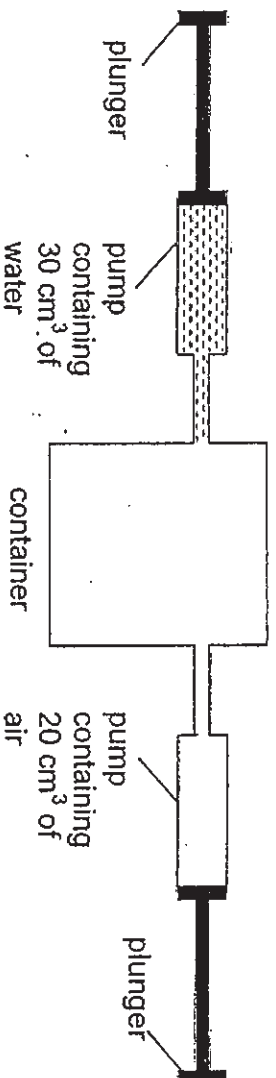

What was the total volume of air in the container when the plungers were completely pushed into the pumps?

- (1) 100 cm^3
 (2) 120 cm^3
 (3) 150 cm^3
 (4) 170 cm^3

- 21 Chloe transferred substance X from container P to container Q. Then she placed container Q in the freezer until substance X changed its state. Next, Chloe removed the container Q from the freezer and tilted it as shown in the diagram below.

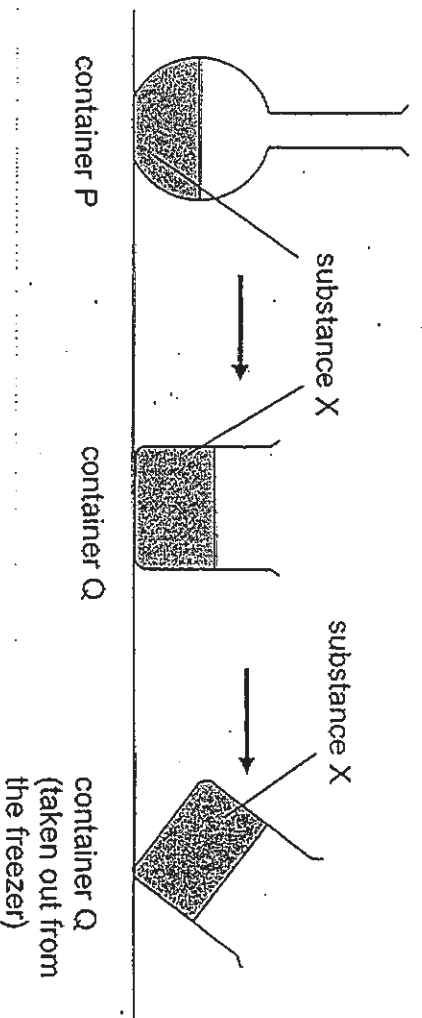

Based on the information above, what could substance X possibly be?

- A oil
 B sand
 C water
- (1) B only
 (2) C only
 (3) A and C only
 (4) A, B and C

22

The circuit card shown below has a metal thumbtack at each point, A, B, C and D. Some of the thumbtacks are connected by wires behind the card.

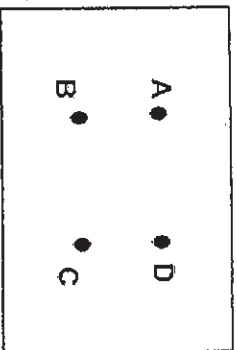

circuit card

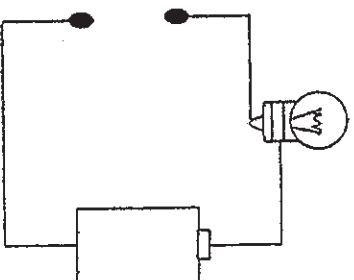

circuit tester

A circuit tester is used to test the circuit cards. The results are recorded in the table below.

Circuit tester connected to thumbtacks at	Does the bulb light up?
A and C	yes
B and D	no
B and C	yes

Which one of the following circuit cards shows the correct connections of the wires?

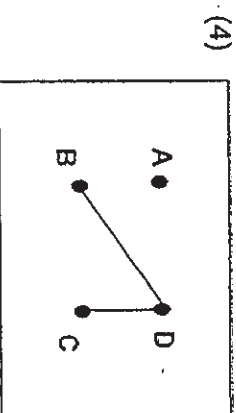
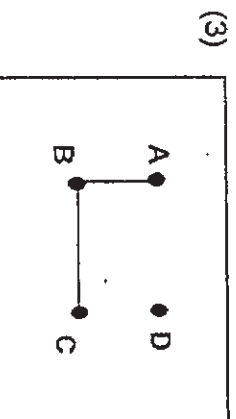
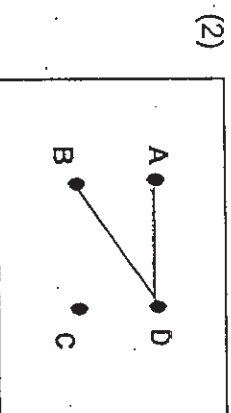
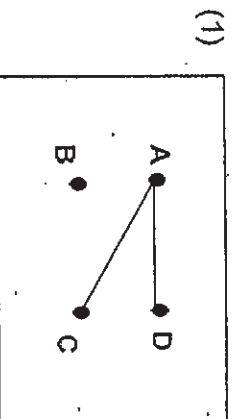

23

Sandy wanted to find out if the arrangement of dry cells in a circuit affects their brightness. She set up the following circuits using identical components.

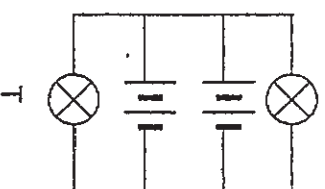
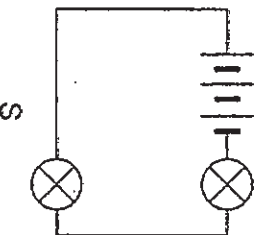
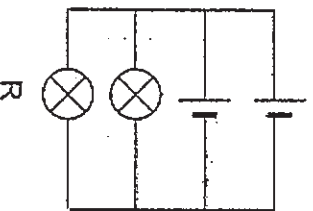
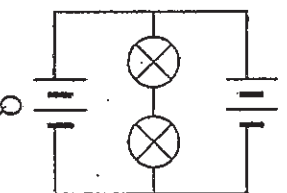
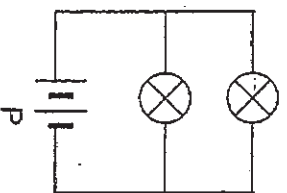

Which of these two circuits should Sandy use to ensure a fair test?

- (1) P and R
- (2) P and S
- (3) Q and S
- (4) Q and T

24

Alan placed objects W, X, Y and Z below identical magnets, which were attached to identical elastic bands, as shown in the diagrams below.

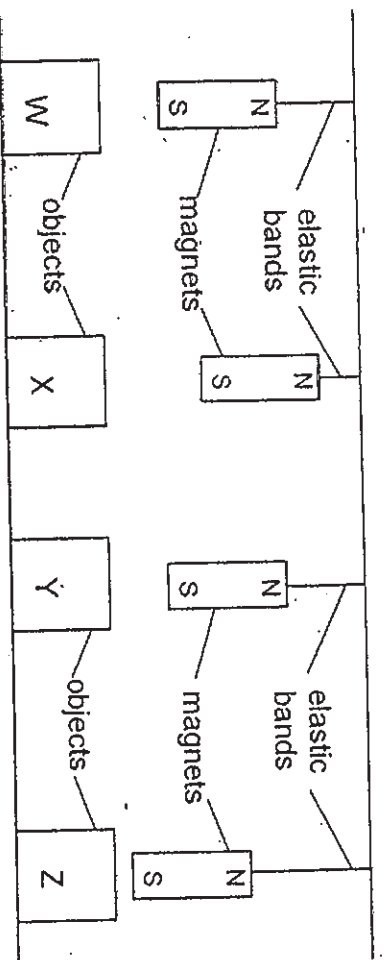

Based on the information above, which of the following statements is/are true?

- A Z was a magnet.
- B W and Y were not made of magnetic materials.
- C Unlike poles of X and the magnet were facing each other.

- (1) A only
- (2) B only
- (3) B and C only
- (4) A, B and C

- 25 Object X was placed at a fixed point at the bottom of the ramp with a rough surface.

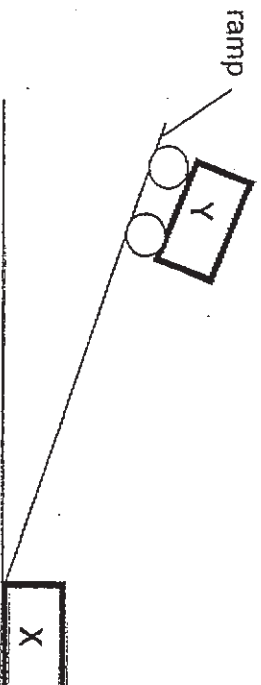

Object Y, with wheels attached to it, was released from the top of the ramp. It rolled down the ramp and stopped close to object X suddenly as shown in the diagram below.



Which of the following could possibly explain why Y stopped close to X?

- A Friction prevented X from moving forward.
 - B Like poles of magnets X and Y were facing each other.
 - C Gravity acting on X was greater than gravity acting on Y.
 - D Friction prevented Y from reaching the bottom of the ramp.
- (1) B only
(2) C only
(3) A and B only
(4) A, B, C and D.

The original length of the spring was 7 cm. John used the spring to make a weighing machine as shown in the diagram below.

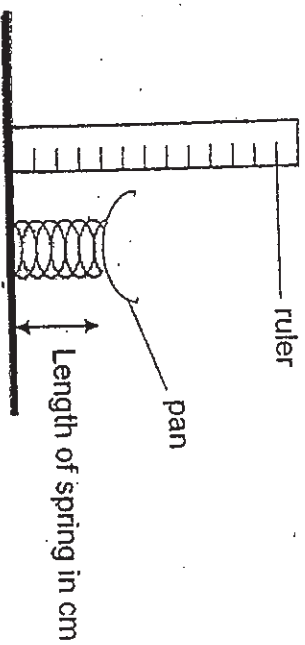

John added weights, 10 g at a time, to the pan and measured the length of the spring. Each time a weight was added, he measured the length of the spring.

Next, he removed the weights, one at a time, till all the weights were removed. He also measured the length of the spring each time a weight was removed.

Which one of the following graphs shows the results of John's experiment?

(1)

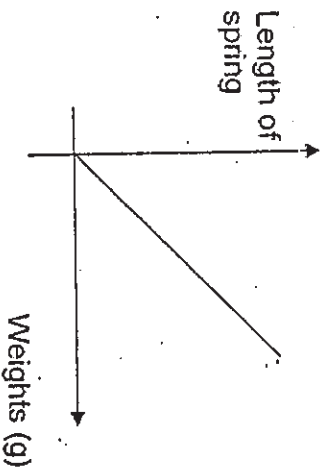

(2)

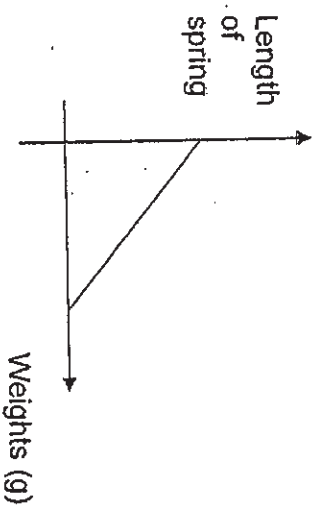

(3)

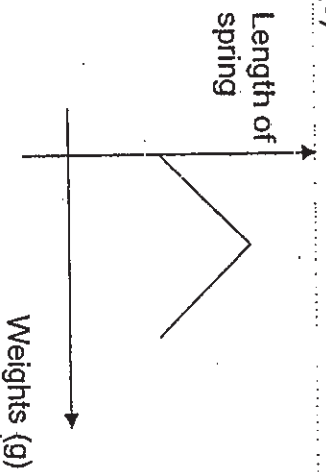

(4)

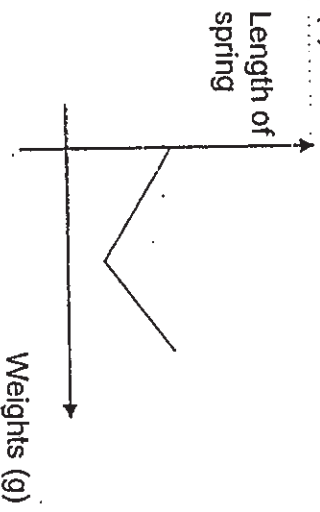

27 Sally dropped her ball that glowed in the dark into the deep drain. She wanted to retrieve her ball but she could not see it.

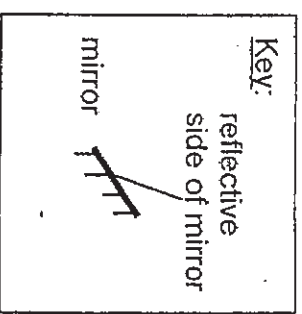
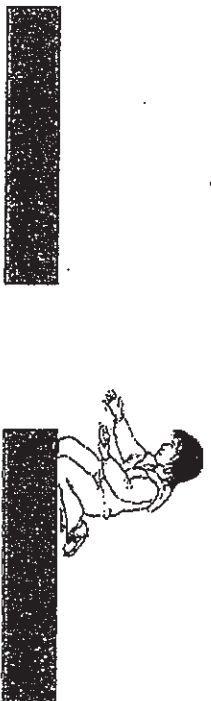

Sally lowered a mirror into the drain and placed it at position R.

At which angle should Sally place the mirror to see the ball in the drain?

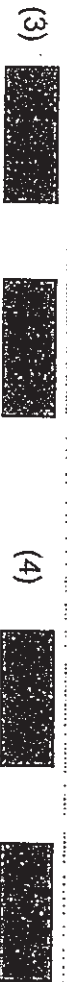

Mrs Tan placed a bottle of hot milk into a basin of cold water as shown in the diagram below.

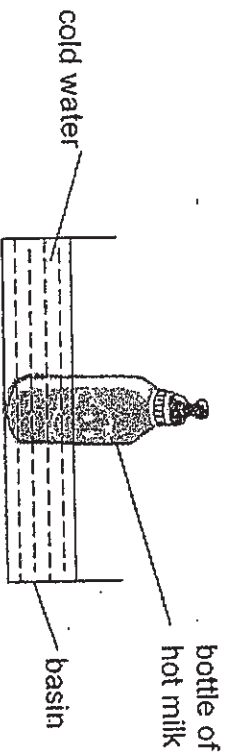

Which one of the following graphs shows the temperatures of the hot milk and the cold water after ten minutes?

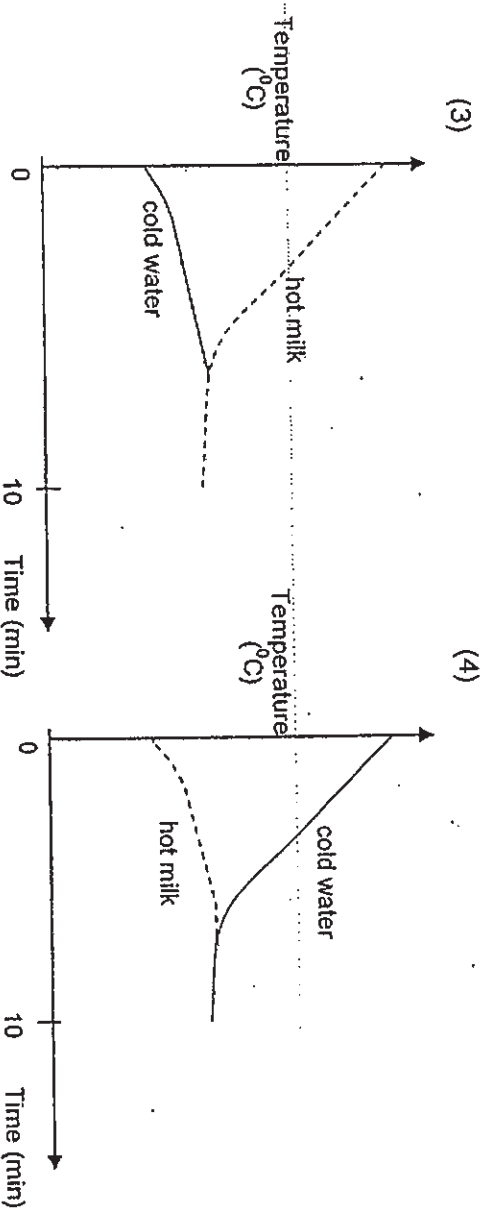
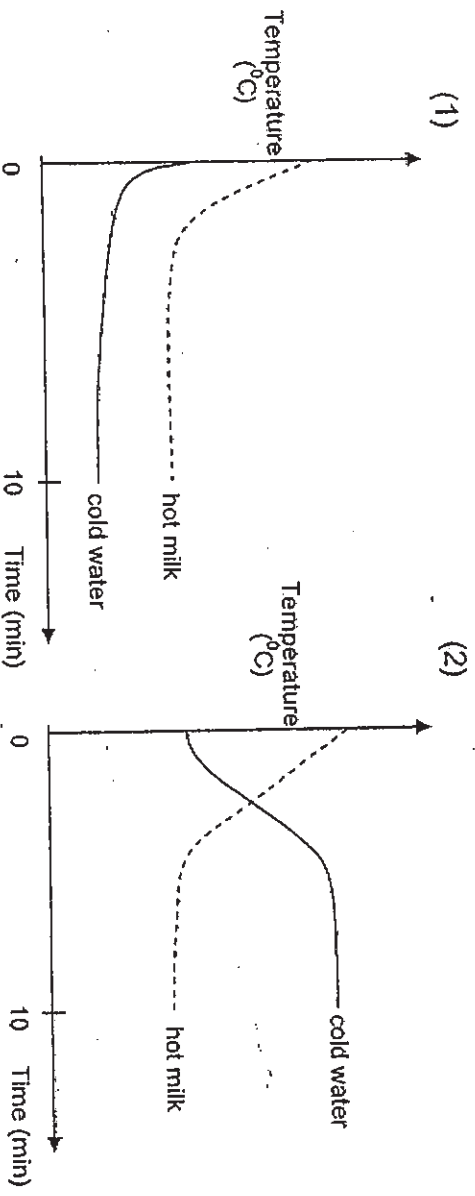

- 29 John wanted to put the metal ball to pass through the metal ring. However, the size of the metal ball was bigger than the metal ring.

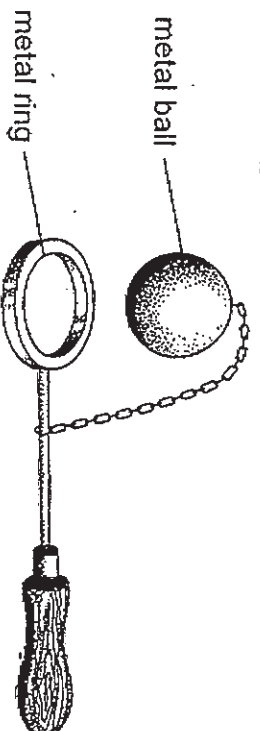

What should John do to allow the metal ball to pass through the metal ring?

- A Heat the ball over a flame
 - B Heat the ring over a flame
 - C Dip the ball into the cold water
 - D Dip the ring into the cold water
- (1) A only
 - (2) B only
 - (3) A and D only
 - (4) B and C only

- 30 Sally released a tennis ball from the top of ramp X. The ball rolled downwards, travelled up and down ramp Y and was finally stopped by a wooden block Z as shown in the diagram below.

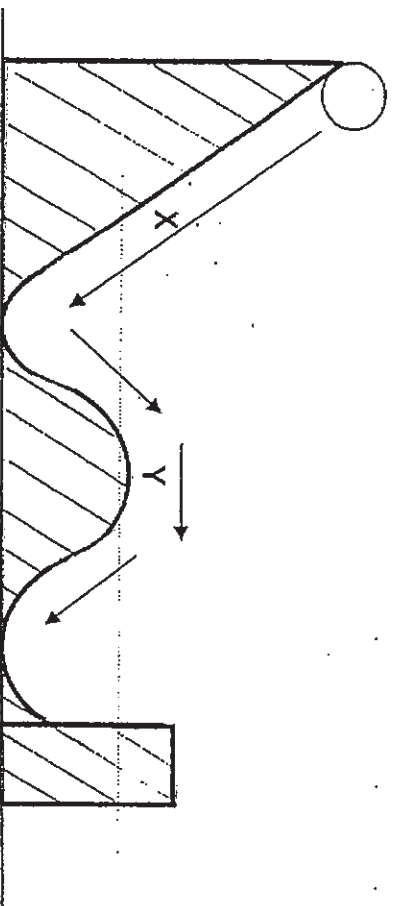

Which one of the following statements is correct?

- (1) When the ball was stopped by Z, its energy was destroyed.
- (2) When the ball was released, it gained gravitational potential energy.
- (3) The ball gained more kinetic energy when it was rolling down X than when it was rolling down Y.
- (4) There was no friction between the surfaces of the ball and the ramps when the ball was rolling down the slope.

Name: _____

Index No: _____ Class:P6 _____

40

SECTION B (40 marks)

For questions 31 to 44, write your answers clearly in the spaces provided.

The number of marks available is shown in brackets [] at the end of each question or part question.

31 The flow chart below classifies some organisms.

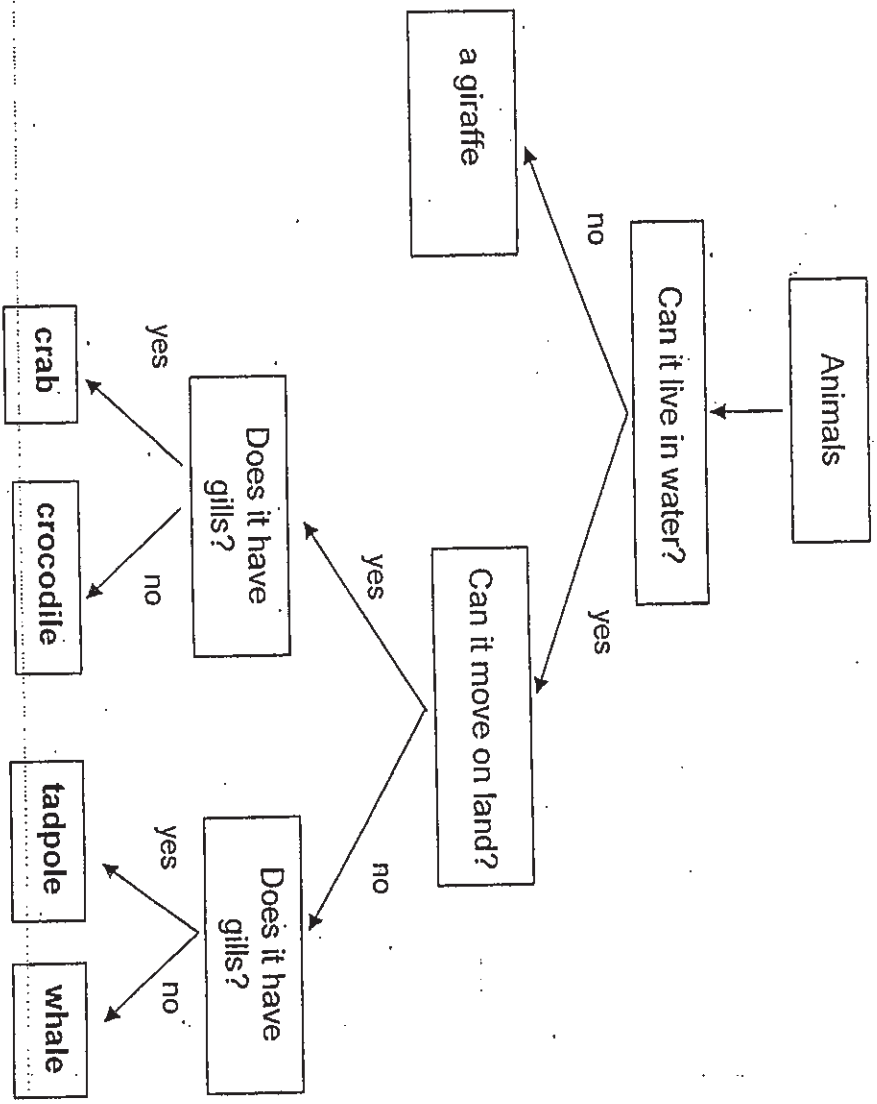

Based on the information above, answer the following questions:

(a) State a similarity between 'crab' and 'whale'. [1]

(b) List two characteristics of the crocodile. [2]

CHARACTERISTIC 1	
CHARACTERISTIC 2	

The table below shows some characteristics that Jason and his family members possess.

family member	characteristics		
	eye colour	eyelids	hair length
Jason's grandfather	black	single	long
Jason's grandmother	brown	double	short
Jason's father	brown	double	short
Jason's mother	brown	single	long
Jason	black	?	long

Based on the information above, answer the following questions:

- (a) Would Jason have single or double eyelids? Explain your answer. [1]

- (b) Why does Jason have black eyes although his parents have brown eyes? [1]

33

Michelle placed a few leaves in a beaker of water at 70°C. After a short while, she observed some air bubbles formed on both sides of each leaf.

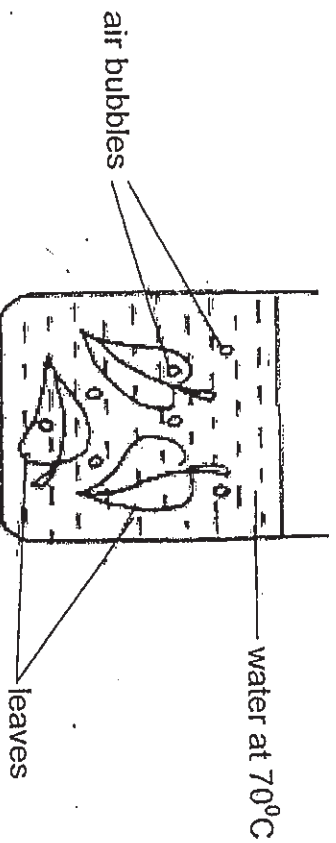

- (a) Name the part of the leaf where the bubbles escaped from. [1]

- (b) Michelle observed that there were more bubbles on the underside of the leaves.

What could she conclude from her observation? [1]

34 The diagram below shows three different groups of cells.

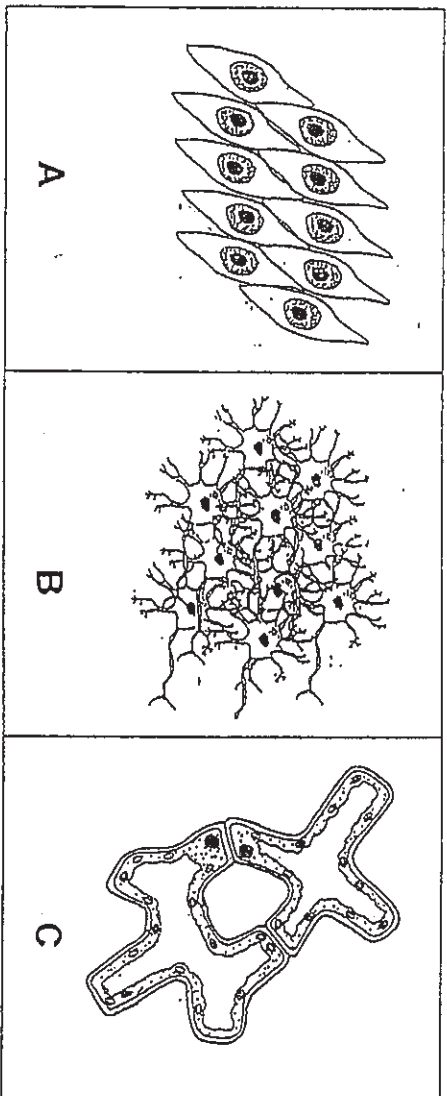

Which of these cells (A, B and/ or C) is a /are plant cell(s)?
Give a reason for your answer.

[2]

35 Kimberly set up a 'bottle garden' and placed it outside the classroom near the windows.

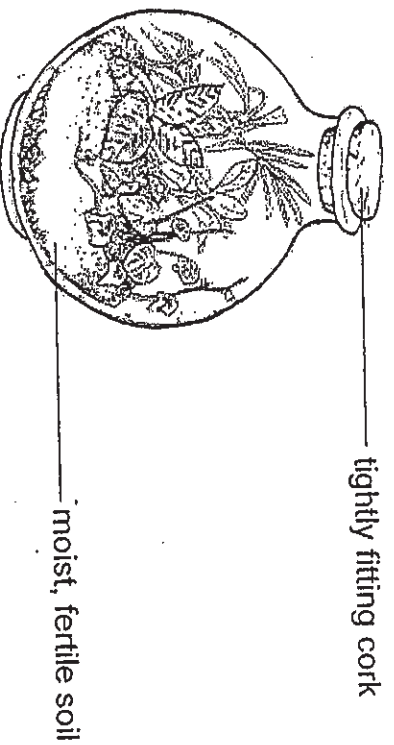

- (a) Kimberly did not water the 'bottle garden'. Explain why the plants in the 'bottle garden' were still able to obtain a continuous supply of water. [2]

Kimberly introduced a carnivorous animal X in the bottle garden and it continued to survive for the next 3 days.

The bottle garden supplied sufficient water for animal X and the plants.

- (b) Explain how animal X and the plants were interdependent on each other. [2]

36 The picture below shows a wombat.

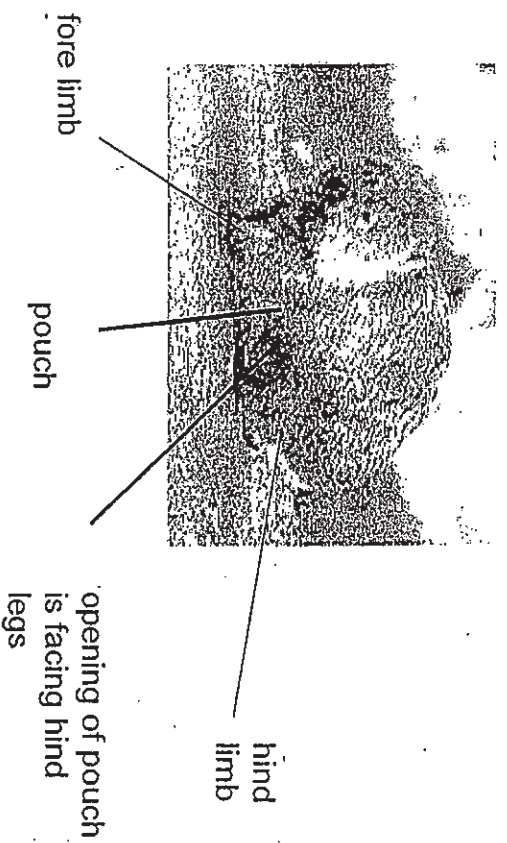

Wombats are Australian marsupials. They dig and burrow into the ground. The females carry their young in pouches which face backwards.

- (a) Explain how having such a pouch helps its young when the wombat burrows into the tunnel. [1]

- (b) Besides its rodent-like front teeth, name **ANOTHER** structural adaptation a wombat has to enable it to dig tunnels or burrow easily. [1]

- 37 Susan carried out an investigation on the property of air using three identical plastic cups, A, B and C, and a basin of water. A hole was made in each of cups B and C.

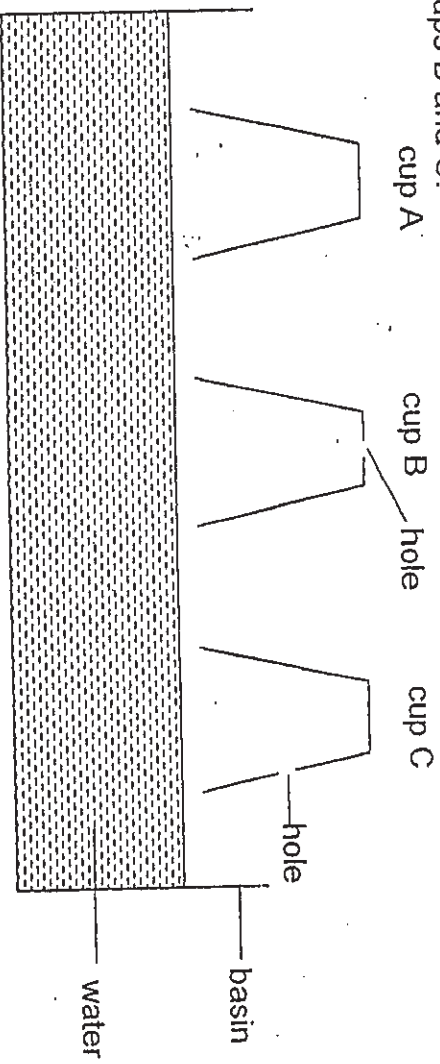

The cups were pushed vertically downwards into the basin of water as shown in the diagram below.

- (a) Complete the diagram by drawing in the correct water levels in cups B and C when they were held in the positions as shown below.

The water level in cup A has been drawn for you. [2]

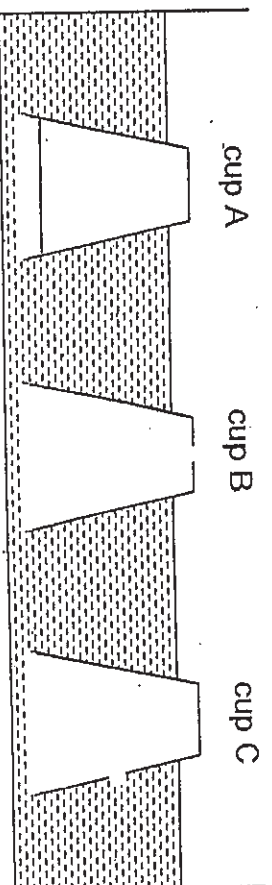

- (b) Explain your answer in part (a) for cup B. [2]

38

The diagram below shows a circuit. The table shows what happens to the light bulb when four different rods, A, B, C and D, were connected, one at a time, to the contact points X and Y.

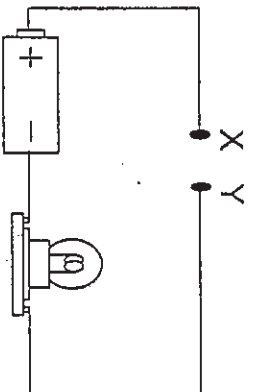

rod across XY	Did the bulb light up?
A	yes
B	no
C	no
D	yes

(a) What can be said about the rods from the results above? [1]

In another experiment, the same four rods, A, B, C and D, were placed at different positions, S1, S2, S3 and S4, in the following circuit.

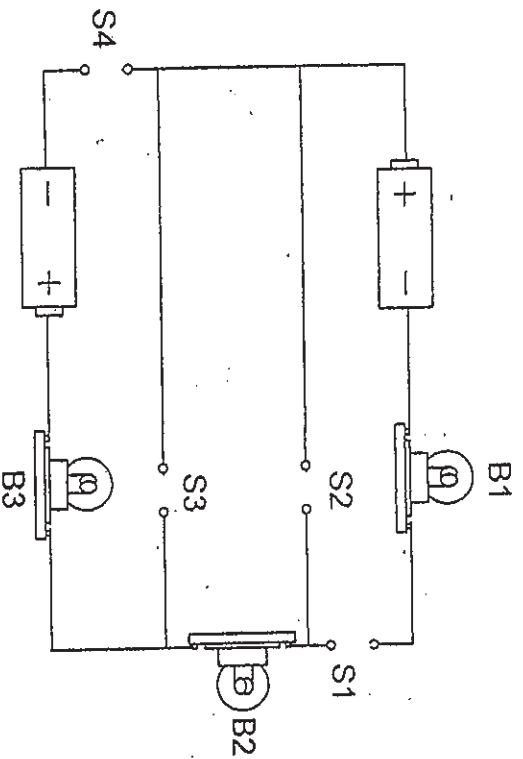

- (b) Complete the following table.
Put a tick (✓) in the appropriate box to show that the bulb lit up. [11]

position where each rod was placed				bulbs		
S1	S2	S3	S4	B1	B2	B3
B	D	C	A			

- (c) All the 3 bulbs, B1, B2 and B3, lit up.

Write letters A, B, C or D in each appropriate box below. [11]
Each letter can be written **ONCE** only.
A tick (✓) in the box shows that the bulb lit up.

position where each rod was placed				bulbs		
S1	S2	S3	S4	B1	B2	B3
				✓	✓	✓

39

An iron rod becomes a magnet when it is placed in a coil of wire connected to the dry cells.

Sally wanted to find out whether the number of turns of the coil affects the strength of a magnet. Using two identical iron rods, some identical wires and some identical dry cells, she set up two arrangements as shown below.

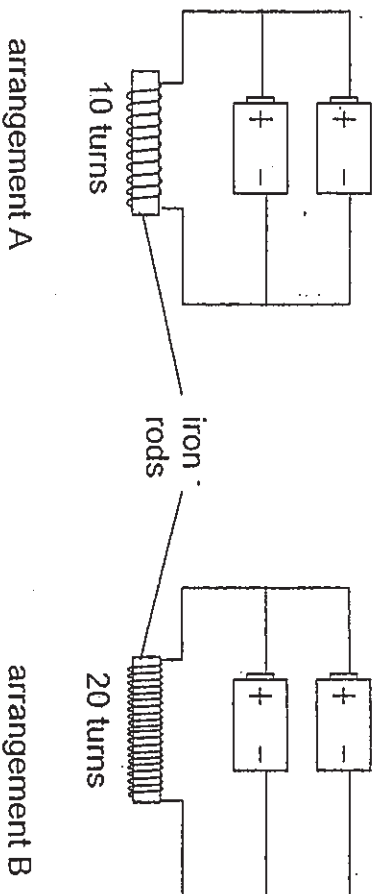

- (a) What should Sally measure to find out the strength of the magnetised iron rod in each arrangement using **ONLY** a paper clip and a ruler? [2]

- (b) Besides increasing the number of turns of coils, suggest **ANOTHER** method to increase the strength of the magnetised iron rod for each arrangement. [1]

- (c) How can Sally improve the reliability of her results? [1]

- 40 Karen stretched a strong rubber band between 2 nails on a board as shown below.

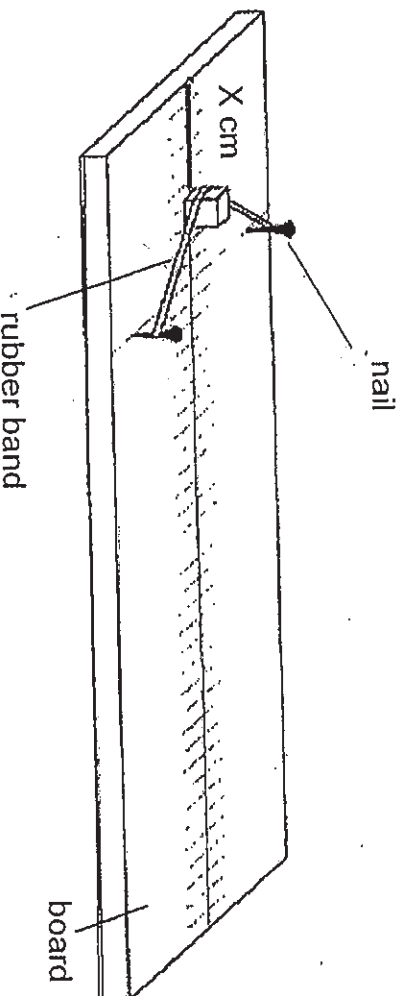

She pulled back a wooden cube against the rubber band. When she released it, the cube shot forward. She did this several times, each time pulling the rubber band back at a different distance.

She recorded her results in the table below.

length of X (cm)	2	3	4	5	6
distance the cube travelled (cm)	63	55	42	(a)	15

- (a) Predict the distance moved by the cube when length of X was 5 cm. [1]

- (b) If Karen were to repeat the experiment using a bigger and heavier cube of the same material, predict the relationship between the mass of the cube and the distance it would travel. [1]

- 41 A row of shophouses with glass windows were built opposite the road junction:

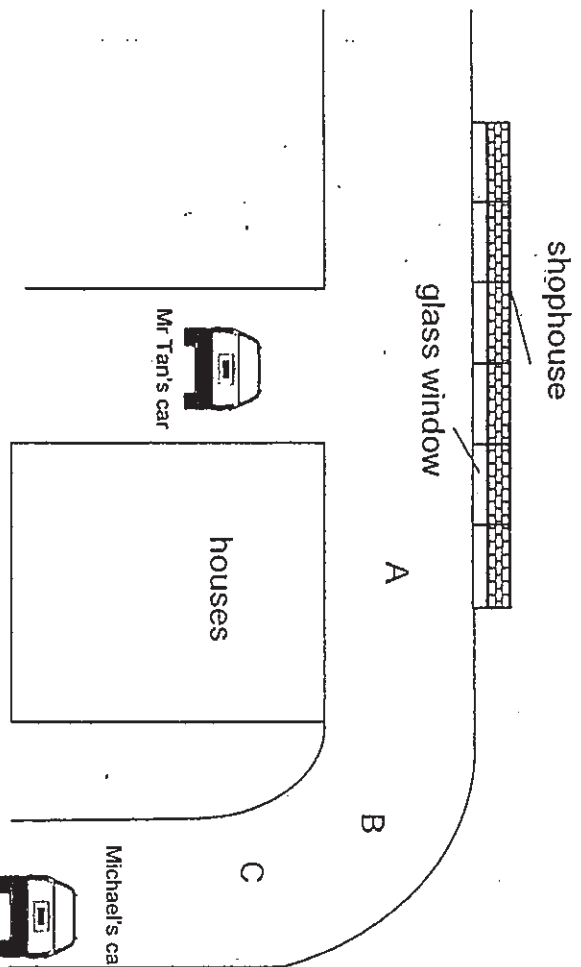

Michael is driving his car round the bend. The houses blocked Mr Tan's view of Michael's car round the bend.

- (a) At which position, A, B or C, will Michael's car be when Mr Tan first sees it? [1]

- (b) Explain how the glass windows on the shophouses help Mr Tan to see Michael's car. [2]

- (c) State the property of light illustrated in the above situation. [1]

42 A company made a new material called 'Keepwarm' to make winter coats.

A scientist tested 'Keepwarm' to find out how well it can retain heat. She tested 'Keepwarm' and three other materials. She poured 50 ml of water in each of the 4 identical beakers and wrapped each beaker with a different material.

She recorded her observations in the table below:

in beaker

time (minutes)	temperature of water (°C) wrapped with			
	material A	material B	material C	material D
0	80	80	80	80
20	68	60	58	62

Based on the information above, answer the following questions:

The scientist said that 'Keepwarm' was the best material to make coats.

Which material, A, B, C or D, was 'Keepwarm'?

Explain why the scientist made the above comment. [2]

- 43 The diagram below shows a piling machine used in construction sites. A hammer drives piles into the ground.

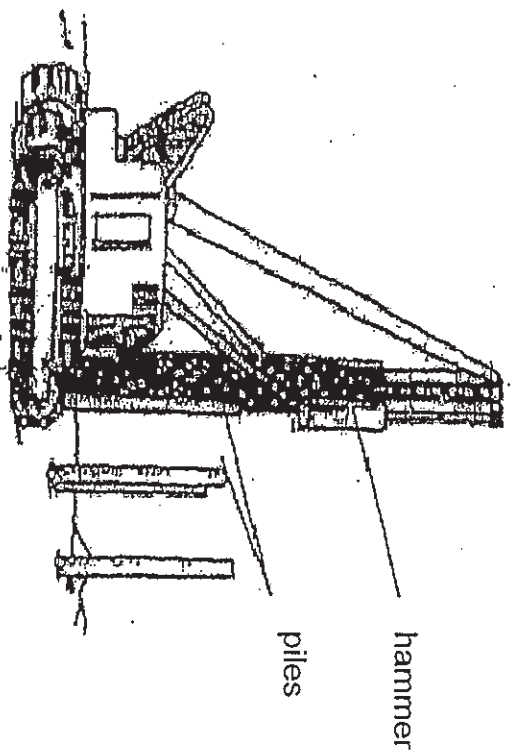

- (a) State the relationship between the height from which the hammer is dropped and the depth of the pile driven into the ground. [1]

- (b) State the energy change that takes place when the hammer is dropped on the pile. [2]

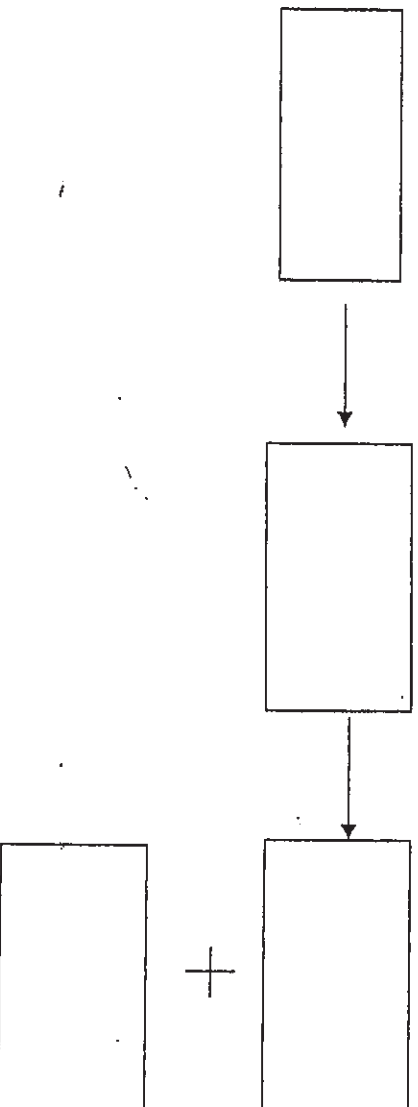

44 Mathilda balanced two paper cups, A and B, on a rod as shown in the diagram below.

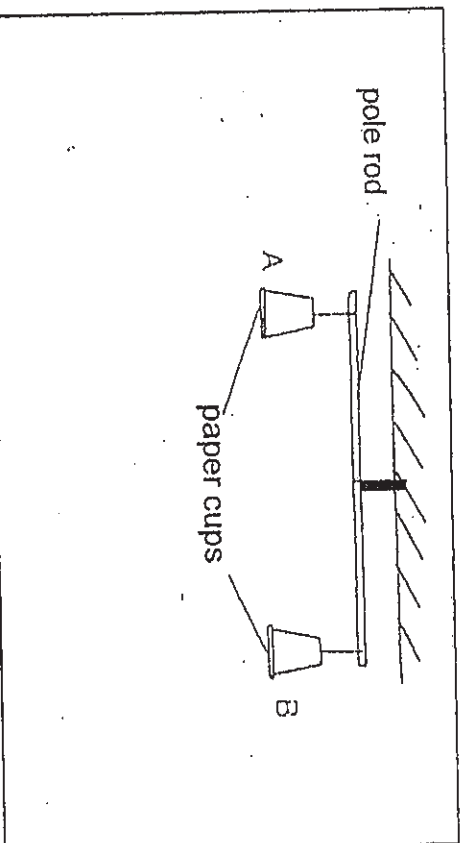

Next, she placed a lighted candle directly below paper cup A and made some observations.

(a) In the space below, **DRAW** how the set-up would look like when the candle was lit. [1]

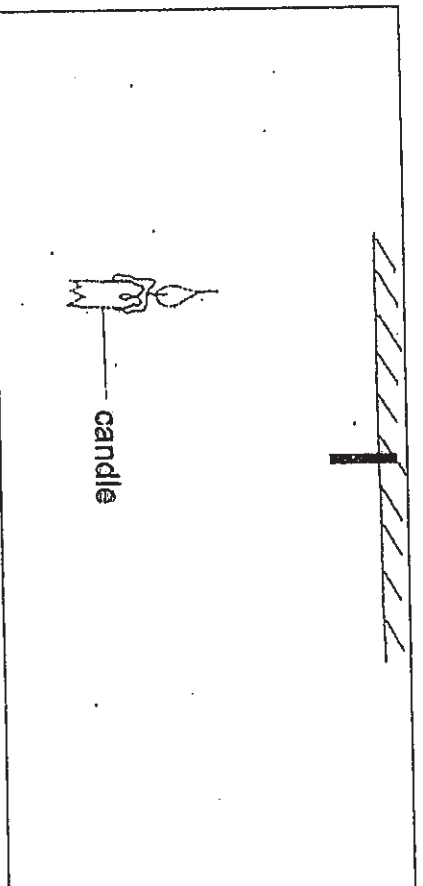

(b) Complete the boxes below. Trace the energy transfer that took place from the burning candle. [2]

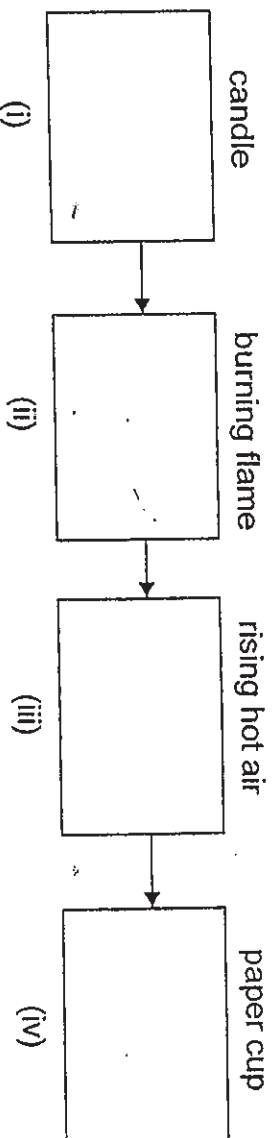

- END OF PAPER -

Setters: Mrs Christina Lim, Mdm Lim Sok Yen, Mrs Martha John and Miss Lee Suan Khim

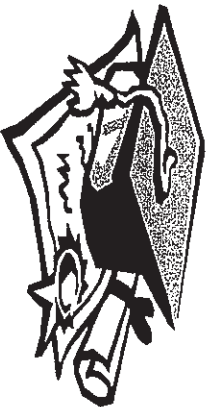

ANSWER SHEET

EXAM PAPER 2010

SCHOOL : RAFFLES GIRLS' PRIMARY
SUBJECT : PRIMARY 6 SCIENCE

TERM : PERLIMINARY

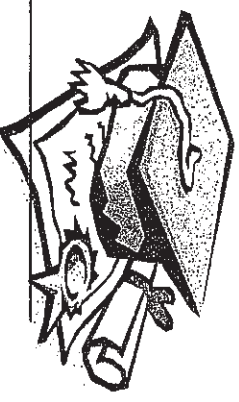

Q1	Q2	Q3	Q4	Q5	Q6	Q7	Q8	Q9	Q10	Q11	Q12	Q13	Q14	Q15	Q16	Q17
1	4	4	2	1	1	3	3	3	2	3	2	1	1	3	4	2

Q18	Q19	Q20	Q21	Q22	Q23	Q24	Q25	Q26	Q27	Q28	Q29	Q30
4	3	2	3	3	1	2	1	2	4	3	4	3

31)a)They both can live in water.

b)1)can live in water. 2)can move on land.

32)a)Jason may have single or double eyelids. It is because he inherited both genes from father who has double eyelids and his mother who has single eyelids, however one of the genes may be masked.

b)He inherited them from his parents who have genes for black eyes which are "masked".

33)a)Stomata.

b)She can conclude that stomata are found on the underside of leaves.

34)Cells A and B have regular shapes, we can conclude that cell A and C are plant cells. However animal cell do not have cell walls, hence as cell B has a irregular shape, we can conclude that it is not a plant cell but an animal cell.

35)a)It is because moisture and air cannot escape the bottle, hence the water in the fertile soil will evaporate when it is being heated by the sun, forming into water vapour, then the water vapour will rise and condense on the cool inner surface of the bottle, forming into tiny water droplets, finally when the water droplets get too big, it will drip back into the soil, thus this ensure a continuous supply of fresh water for the plants to take in through the roots during photosynthesis where by carbon dioxide is taken in and oxygen is given out.

35)b)When animal X respire, it will take in oxygen &give out carbon dioxide, thus the carbon dioxide produced by animal X will be used by the plants during photosynthesis. During photosynthesis, the plants will replenish the oxygen by taking in carbon dioxide and giving out oxygen for animal X to use during respiration, therefore this shows animal X & the plant were interdependent on each other.

36)a)Its young will not be hit by the soil/drop out of the pouch when the adult wombat digs or burrow into the soil.

b)Sharp and hook claws to allow it to dig tunnels or burrow easily.

37)a)

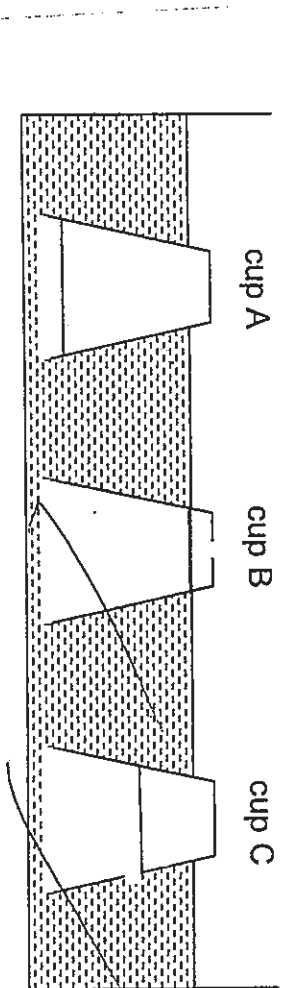

b)Air escape through the hole in cup B to occupy the space/displace the escaped air.

38)a)A and D are conductors of electricity while B and C are insulators of electricity.

b)B2, B3

c)ABCD

39)a)Sally should measure the maximum distance the magnetised iron can attract the paperclip from by using a rule.

b)Use more dry cells./arrange dry cells in series.

c)She could repeat the experiment at least 3 times and record the distances before finding the average distance of which the magnetised iron rod can attract the paperclip from.

40)a)33cm.

b)The greater the mass of the cube the shorter the distance it would travel.

41)a)Position C.

- b)Glass has a smooth surface, hence it reflects light very well,thus when Michael's car was at A, the car reflects the light from a light source to the glass windows before being reflected by the glass window into Mr Tan's eyes, there Mr Tan could see Michael car.
- c)light can be reflected.

42)Material A. It is because material A retained the most heat compared to the three other materials B, C and D, hence it has the highest temperature among, the materials, making it suitable and the vest material to make coats so as to keep us warm. "Keep warm" conducted heat away the slowest/conducted heat slowly poorest conductor of heat.

43)a)The greater the height from which the hammer is dropped, the greater the depth of the pile driven into the ground.

- b)gravitational potential energy \rightarrow kinetic energy \rightarrow heat energy + sound energy.

44)a)

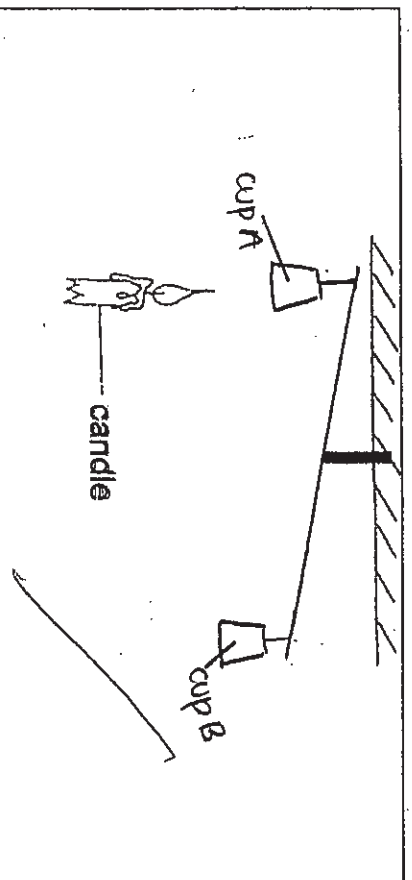

- b)i)chemical potential energy
- ii)heat energy + light energy
- iii)kinetic energy + heat energy
- iv)kinetic energy

