



**RAFFLES GIRLS' PRIMARY SCHOOL
PRELIMINARY EXAMINATION
MATHEMATICS (PAPER 1)
PRIMARY 6**

Name: _____ ()

Form Class: P6 _____

Banded Math Class: P6 _____

Date: 20 August 2014

Duration: 50 min

Your Score	
Paper 1 (Out of 40 marks)	
Paper 2 (Out of 60 marks)	
Overall (Out of 100 marks)	

INSTRUCTIONS TO CANDIDATES

1. Do not turn over this page until you are told to do so.
2. Follow all instructions carefully.
3. Answer **ALL** questions and show all working clearly.
4. **NO** calculator is allowed for this paper.

SECTION A (20 marks)

Questions 1 to 10 carry 1 mark each. Question 11 to 15 carry 2 marks each. For each question, four options are given. One of them is the correct answer. Make your choice (1, 2, 3 or 4). Shade your answer (1, 2, 3 or 4) on the OAS provided. All diagrams are not drawn to scale.

1. Round off 794 499 to the nearest thousand.

(1) 790 000

(2) 794 000

(3) 795 000

(4) 800 000

2. Which one of the following fractions is the largest?

(1) $\frac{1}{8}$

(2) $\frac{1}{10}$

(3) $\frac{1}{9}$

(4) $\frac{1}{11}$

3. $50.13 = 5 \text{ tens} + \boxed{} + 3 \text{ hundredths}$

The missing value in the box is _____.

(1) 1

(2) 0.1

(3) 0.01

(4) 0.001

4. Express 1.056 kilometres in metres.

(1) 0.1056 m

(2) 10.56 m

(3) 105.6 m

(4) 1056 m

5. A rectangle has an area of 56 cm^2 . Given that its breadth is 7 cm, find the perimeter of the rectangle.

(1) 8 cm

(2) 15 cm

(3) 28 cm

(4) 30 cm

6. Which one of the following fractions is closest to 2?

(1) $1\frac{4}{5}$

(2) $1\frac{4}{7}$

(3) $2\frac{1}{6}$

(4) $2\frac{1}{4}$

7. What is $\frac{3}{4}$ of 300?

(1) $\frac{1}{400}$

(2) $2\frac{1}{4}$

(3) 75

(4) 225

8. Find the value of $\frac{1}{5} + 0.641$.

(1) 0.661

(2) 0.841

(3) 0.891

(4) 1.141

9. Paul ran a marathon in 136 minutes. If he started at 11 00, what time did he complete the marathon?

(1) 00 16

(2) 01 16

(3) 12 16

(4) 13 16

10.

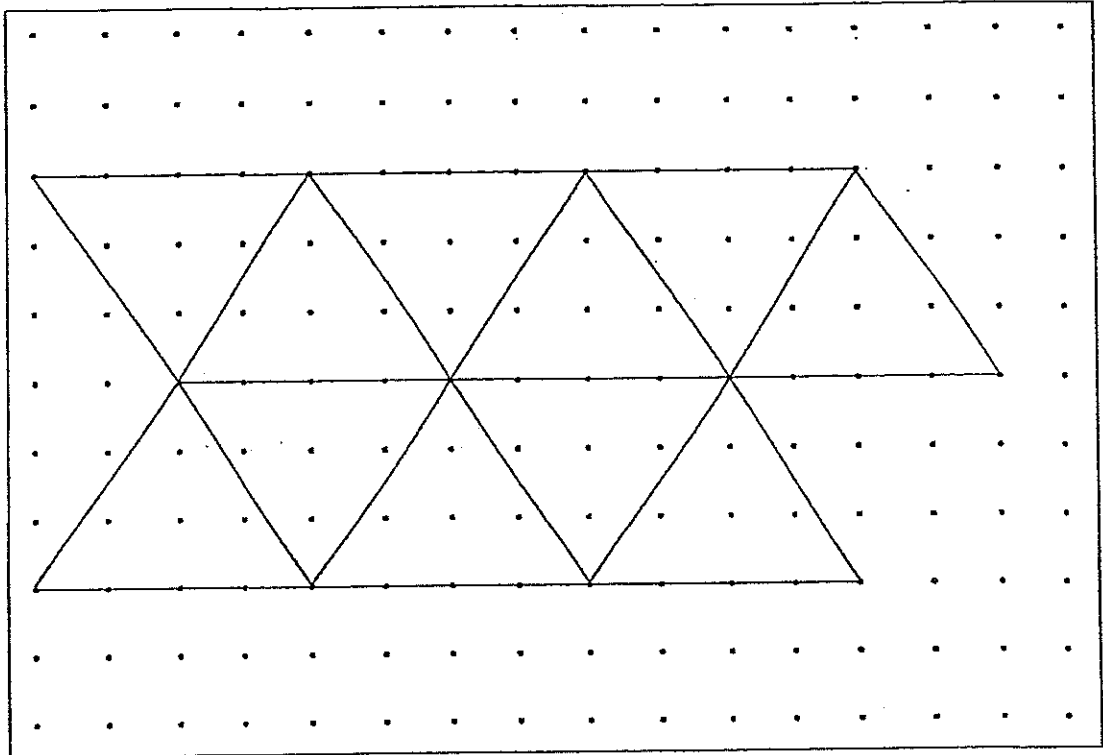

The unit shape in the tessellation above is a _____.

- (1) Triangle
 - (2) Rhombus
 - (3) Trapezium
 - (4) Parallelogram
11. In a stadium, 60% of the 2000 spectators are adults. 80% of the remainder are boys. How many girls are there in the stadium?
- (1) 160
 - (2) 240
 - (3) 640
 - (4) 800

12. The pie chart below shows the types of items sold by a book store in a week. XY is a straight line. $\frac{1}{3}$ of the total items sold were newspapers. Given that 128 comic books were sold, how many storybooks were sold in a week?

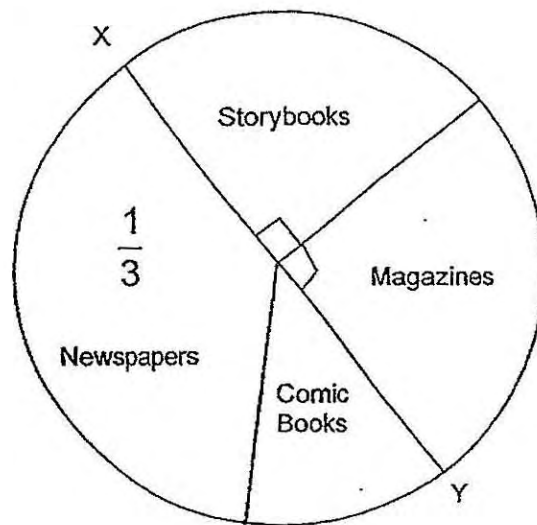

- (1) 160
(2) 192
(3) 256
(4) 768
13. Mary paid \$160 for a kettle during a sale. The original price of the kettle was \$200. What was the percentage discount given for the kettle?
- (1) 20%
(2) 25%
(3) 40%
(4) 80%

14. The figure below shows four identical quadrants inside a square, ABCD.

Find the perimeter of the shaded region. (Take $\pi = \frac{22}{7}$)

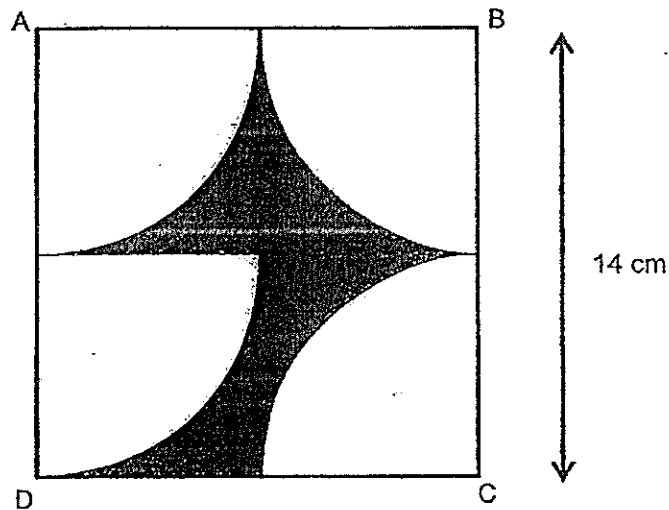

- (1) 22 cm
- (2) 36 cm
- (3) 44 cm
- (4) 58 cm

15. Tap A and Tap B can fill up an empty tank in 4 hours.

Tap B and Tap C can fill up the same empty tank in 6 hours.

Tap A and Tap C can fill up the same empty tank in 3 hours.

How many hours will it take to fill up the empty tank if all the taps are turned on at the same time?

- (1) $\frac{3}{4}h$
- (2) $\frac{3}{8}h$
- (3) $2\frac{2}{3}h$
- (4) $6\frac{1}{2}h$

SECTION B (20 marks)

Questions 16 to 25 carry 1 mark each. Write your answers in the spaces provided. For questions which require units, give your answers in the units stated. All diagrams are not drawn to scale. Answers in fractions or ratio must be expressed in the simplest form.

16. Arrange the following in descending order.

34 845 , 13 972 , 58 748 , 73 924

Ans: _____, _____, _____, _____

17. Express 3.08 as a mixed number in its simplest form.

Ans: _____

18. Find the value of 4.82×4 .

Ans: _____

19. What is the length of the thread shown below?

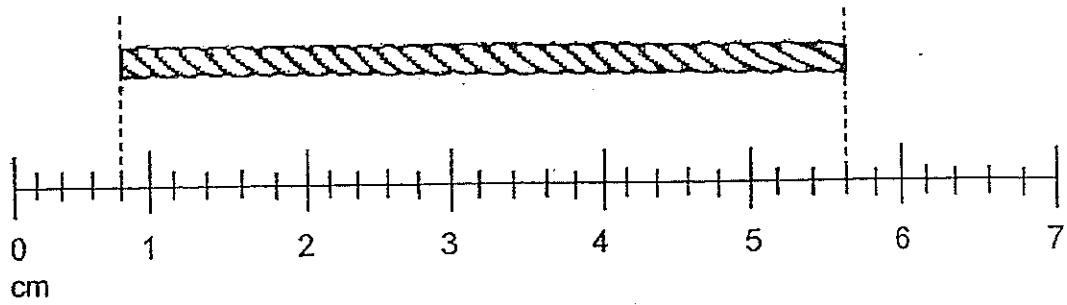

Ans: _____ cm

20. The length of a cube is 7 cm. What is the volume of the cube?

Ans: _____ cm³

21. The bar graph below shows the number of cars sold by ABC company. Given that a total of 129 cars were sold from January to April, how many cars were sold in April?

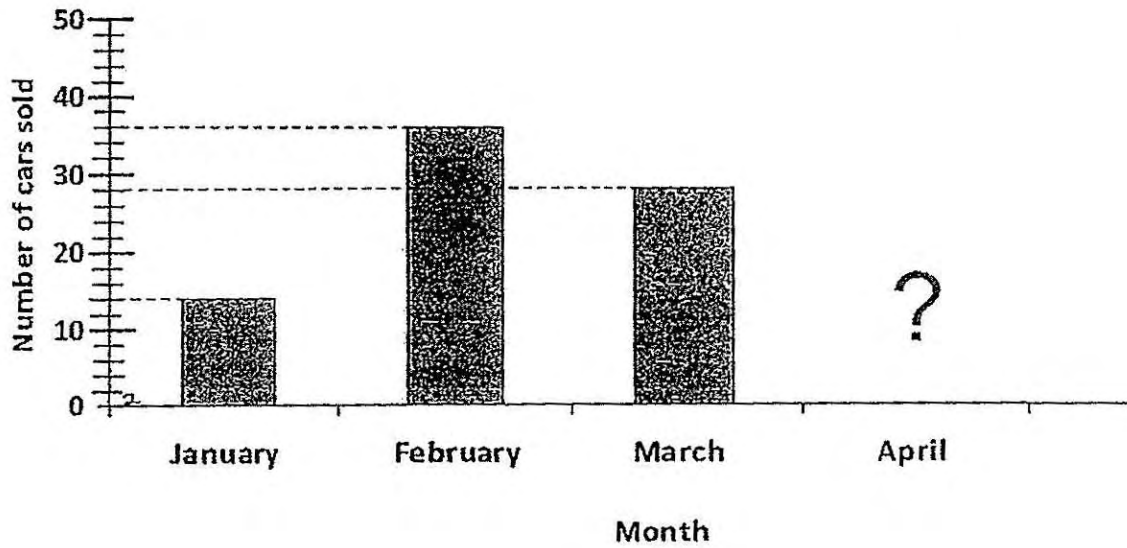

Ans: _____

22. Express 0.03 as a percentage.

Ans: _____ %

23. Express $4\frac{3}{8}$ as a decimal.

Ans: _____

24. The figure below is formed by a rectangle and an isosceles triangle.
Which two lines are perpendicular to line BD?

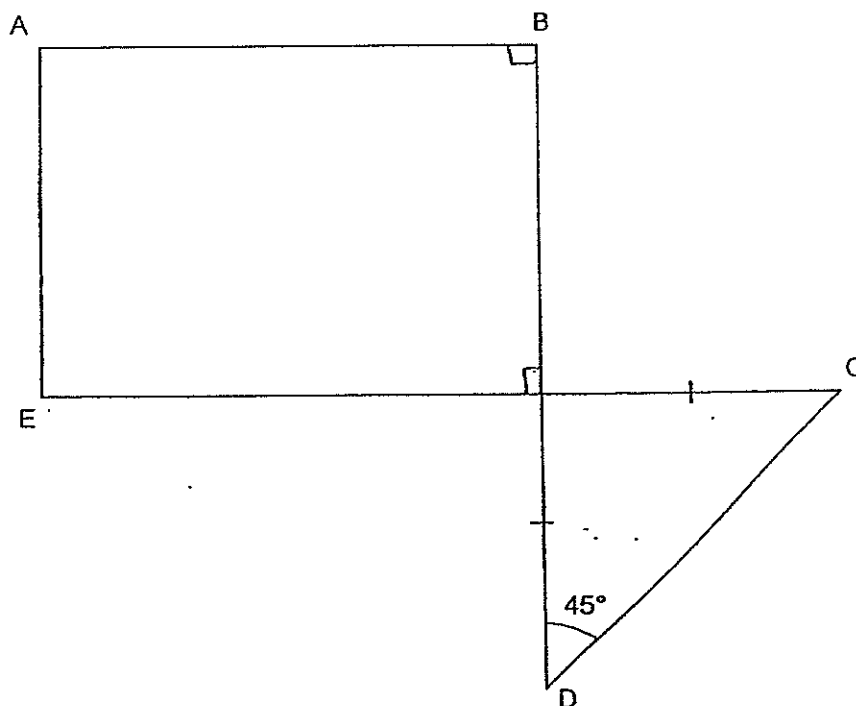

Ans: _____ and _____

25. A is thrice of B, and B is $\frac{4}{5}$ of C. Find the ratio of A : B : C.

Ans: _____

Questions 26 to 30 carry 2 marks each. Show your working clearly in the space provided for each question and write your answers in the space provided. For questions which require units, give your answers in the units stated. All diagrams are not drawn to scale. Answers in fractions or ratio must be expressed in the simplest form.

26. A piece of ribbon is 5 m 20 cm long. 60 cm of the ribbon is cut off to tie a parcel. After that, the remaining ribbon is cut into 4 equal pieces. What is the length of each piece of ribbon?

Ans: _____ cm

27. The figure below is made up of 2 identical rectangles, with one overlapping the other. Given that the length of the rectangle is 15 cm and the breadth is 3 cm, find the area of the figure shown below.

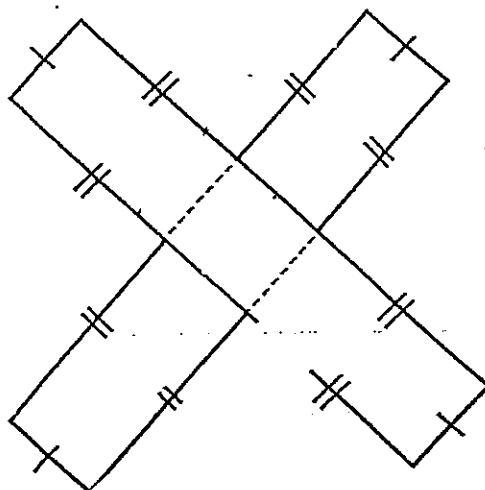

Ans: _____ cm²

28. Jon had 24 marbles and Simon had $20y$ marbles. Simon packed his marbles into 5 bags and gave one bag to Jon. How many marbles would Jon have in the end?
Express your answer in terms of y .

Ans: _____

29. The figure below shows a cube.

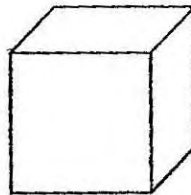

Shade one more square to complete the net of the above cube.

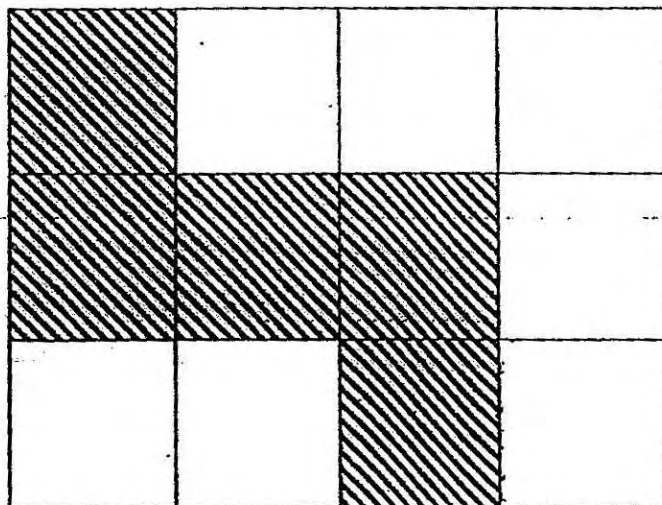

30. Find the value of the missing number in the box.

$$(16 + \square) \times 2 \div 4 = 7$$

Ans: _____

-End of Paper-

☺ Please check your work carefully ☺

**Setters:
Lim L.S.
Luo Z.Q.
Tan K.K.**



**RAFFLES GIRLS' PRIMARY SCHOOL
PRELIMINARY EXAMINATION
MATHEMATICS (PAPER 2)
PRIMARY 6**

Name: _____ ()

Form class: P6 _____

Banded Math Class: P6 _____

Date: 20 August 2014

Duration: 1 h 40 min

Your Score (Out of 60 marks)	
---	--

INSTRUCTIONS TO CANDIDATES

1. Do not turn over this page until you are told to do so.
2. Follow all instructions carefully.
3. Answer **ALL** questions and show all working clearly.
4. The use of calculator is allowed for this paper.

Questions 1 to 5 carry 2 marks each. Show your working clearly in the space provided for each question and write your answers in the spaces provided. Figures are not drawn to scale.

For questions which require units, give your answers in the units stated. (10 marks)

1. Arrange the following fractions in ascending order.

$$\frac{2}{5} \quad , \quad \frac{39}{100} \quad , \quad \frac{21}{50} \quad , \quad \frac{51}{125}$$

Ans: _____, _____, _____, _____ [2]

2. Alan earned a fixed amount of money every month. He spent 60% of his salary and saved \$400. What was his monthly salary?

Ans: \$ _____ [2]

3. AB and AD are two sides of a rhombus ABCD.
 Complete the rhombus by drawing two more lines in the 1-cm square grid below. Label the rhombus. [2]

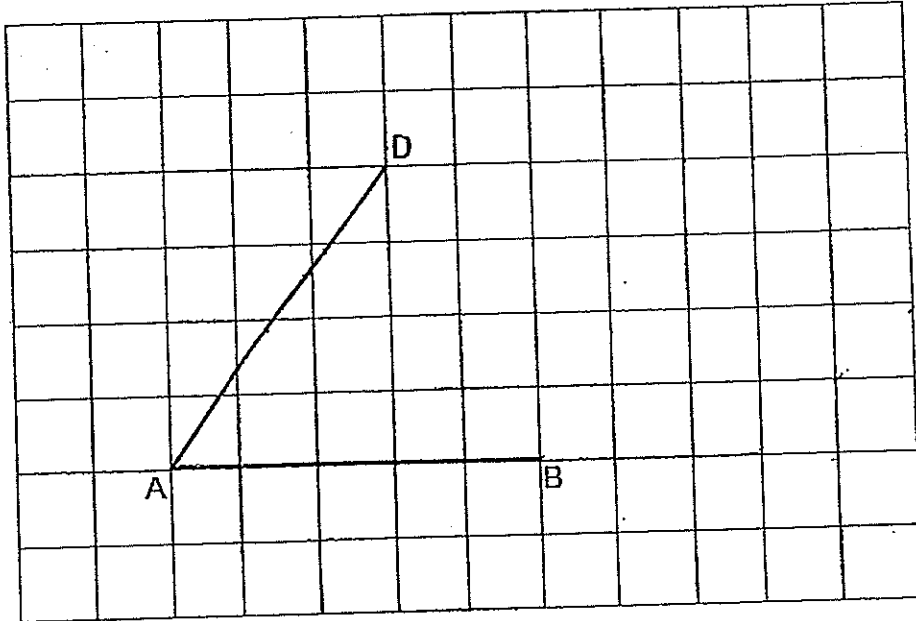

4. Jimmy and Kenneth had \$160 in all. Kenneth had $\$(12n + 6)$ more than Jimmy. How much did Jimmy have if $n = 7$?

Ans: \$ _____ [2]



5. Mr Lau had 24 boxes of oranges. Each box contained 257 oranges. He then repacked the oranges into bags of 20 oranges. How many oranges were left over?

Ans: _____ [2]



For questions 6 to 18, show your working clearly in the space provided for each question and write your answers in the spaces provided. Figures are not drawn to scale. The number of marks available is shown in the brackets [] at the end of each question or part-question. (50 marks)

6. Mrs Jones paid a total of \$38 for $3m$ pens and 4 markers. Each pen cost \$2.
- (a) Express the cost of 1 marker in terms of m .
 - (b) If $m = 4$, how much did each marker cost?

Ans: (a) _____ [2]

(b) _____ [1]

7. Wei Ming and Muthu played a game for 10 rounds. In each round, the winner scored 2 points while the loser was deducted 2 points. At the end of the game, Muthu's total score was 4 points. How many rounds did Wei Ming lose?

Ans: _____ [3]



8. In the diagram below, ABCD is a parallelogram. $AC = CE = CF$.
 $\angle AEC = 55^\circ$ and $\angle AFC = 30^\circ$. AF and CE are straight lines. Find $\angle ABC$.

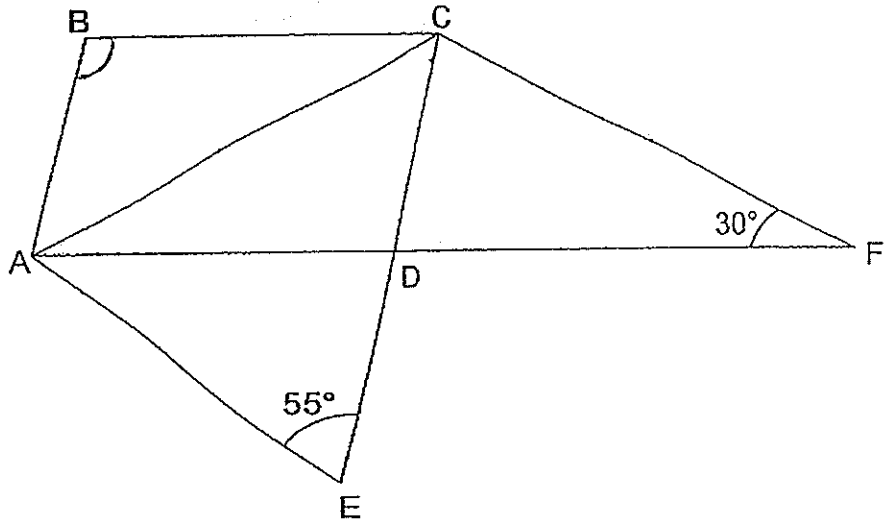

Ans: _____ [3]

9. Kevin baked some cheese muffins and some walnut muffins. After he sold $\frac{1}{4}$ of the cheese muffins and $\frac{5}{7}$ of the walnut muffins, he had $\frac{1}{2}$ as many cheese muffins as walnut muffins left. If Kevin baked 68 more walnut muffins than cheese muffins, find the total number of muffins he baked.

Ans: _____ [3]



10. The pie chart below shows the amount of money collected from the sales of different types of items in a supermarket in a week.

- (a) If the amount of money collected from the sale of all the items was \$50 000 in a week, how much money was collected from the sales of the dairy products?
- (b) What fraction of the money collected was from the sales of the vegetables?

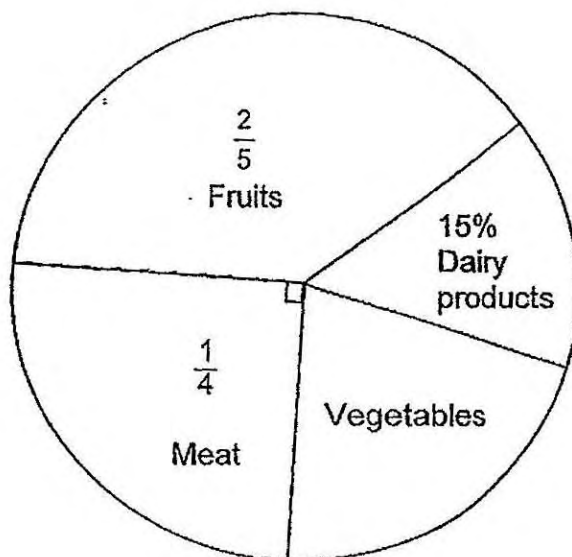

Ans: (a) _____ [1]

(b) _____ [2]

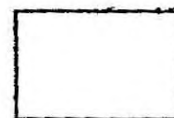

11. A tank was $\frac{2}{3}$ filled with water to a height of 20 cm.

(a) What is the capacity of the tank?

(b) When a glass ball was dropped into the tank, the height of the water level was 1.5 cm from the brim of the tank.

Find the volume of the glass ball.

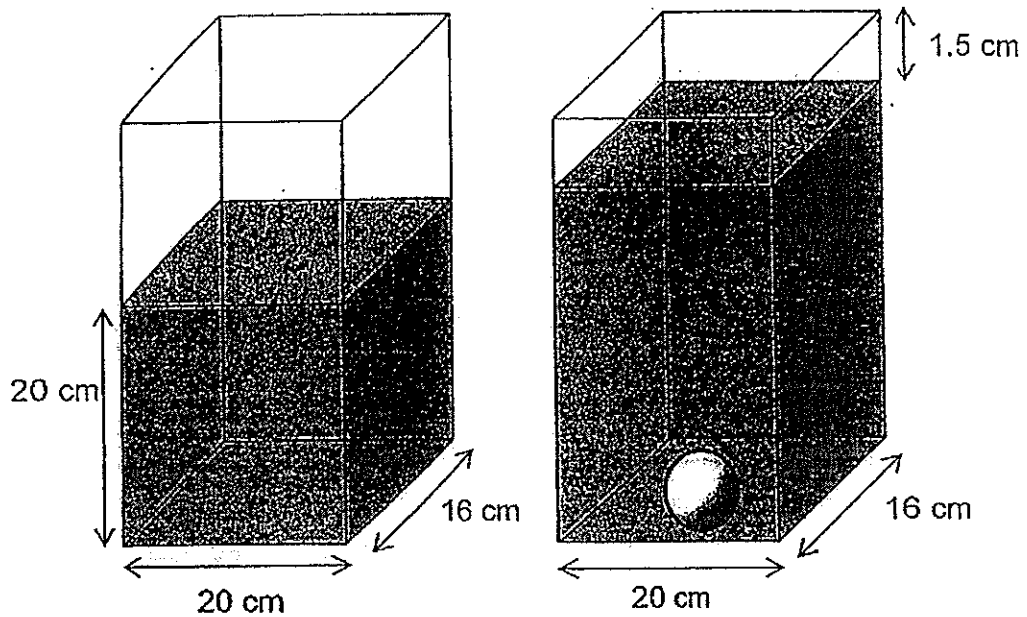

Ans: (a) _____ [2]

(b) _____ [2]



12. Mr Koh had some money. He spent $\frac{1}{5}$ of it on a watch and $\frac{3}{8}$ of the remainder on a golf set. The amount of money left was \$1492 more than the golf set.
- (a) What fraction of the total amount of money was left?
- (b) How much more did Mr Koh spend on the golf set than the watch?

Ans: (a) _____ [1]

(b) _____ [2]



13. During a sale, 6 shelves and 11 vases cost \$1471.35.
If Lydia bought 9 shelves and 16 vases, she would have spent all her money.
Each shelf cost \$172.55 more than a vase.
Find the amount of money Lydia had at first.

Ans: _____ [4]



14. Mrs Wong baked some cookies and tarts for sale. The ratio of the number of cookies to the number of tarts was $5 : 3$. After she sold 486 cookies and 149 tarts, the number of cookies left to the number of tarts left was $4 : 7$.
- (a) Find the total number of cookies that Mrs Wong baked at first.
- (b) How many more tarts than cookies were left?

Ans: (a) _____ [3]

(b) _____ [2]

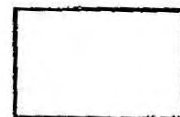

15. A group of visitors at a zoo was made up of teachers and pupils. 8% of them were teachers. Entrance fee for each teacher and each pupil was \$18 and \$10 respectively. The group paid \$4522 for the entrance fee.

- (a) How much money did the teachers paid altogether?
- (b) 1 in every 6 pupils would receive a goodie bag. How many pupils received the goodie bag?

Ans: (a) _____ [3]

(b) _____ [2]



16. The figure below is made up of identical quadrants.

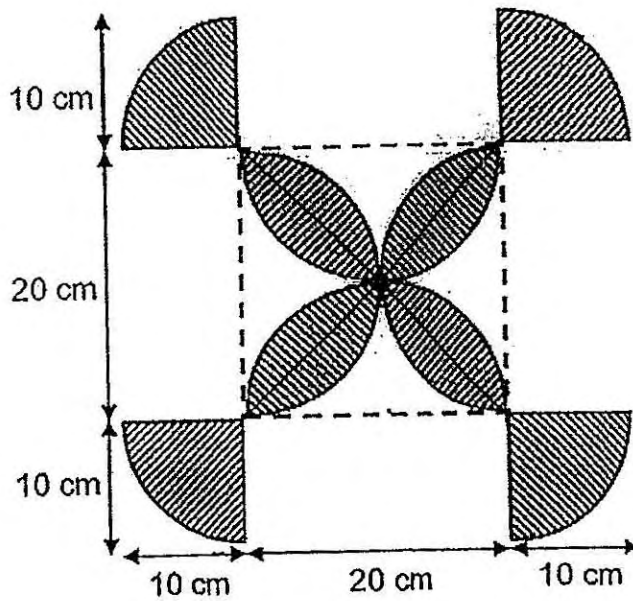

Take π as 3.14.

- (a) Find the area of the shaded part.
- (b) Find the perimeter of the shaded part.

Ans: (a) _____ [3]

(b) _____ [2]

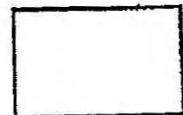

17. Mary started cycling from home to school at a speed of 300 m/min at 6 a.m.. Her brother started cycling from home later. They were beside each other at 6.30 a.m. and her brother reached school at 7 a.m. while Mary was still 1800 m away. If both of them travelled at a constant speed throughout the journey, what time did her brother leave home?

Ans: _____ [4]



18. The diagram below shows a tank made of some identical sections.
Figure A shows one section of the tank.

- (a) Find the volume of figure A.
(b) 5616 cm^3 of water was poured into the tank.
Find the water level in the tank.

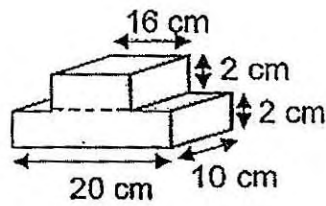
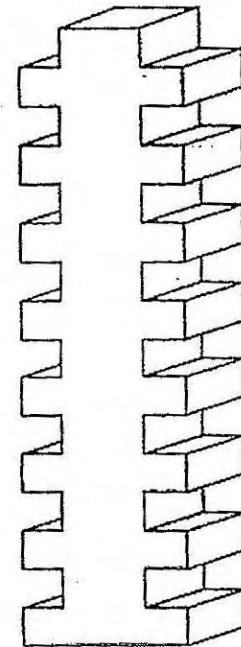

Figure A



Tank

Ans: (a) _____ [2]

(b) _____ [3]

-End of Paper-

Please check your work carefully ©

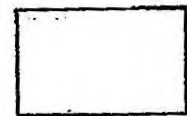

Setters: Lim L.S.
Luo Z.Q.
Tan.K.K.

ANSWER SHEET

EXAM PAPER 2014

SCHOOL : RAFFLES GIRLS'

PRIMARY : P6

SUBJECT : MATHEMATICS

TERM : SA2

Q1	Q2	Q3	Q4	Q5	Q6	Q7	Q8	Q9	Q10	Q11	Q12	Q13	Q14	Q15
2	1	2	4	4	3	4	2	4	1	1	2	1	4	3

16) 73924, 58748, 34845, 13972

17) $\frac{32}{25}$

18) 19.28

19) 4.8 cm

20) 343 cm³

21) 51 cars

22) 3%

23) 4.375

24) AB and EC

25) 12 : 4 : 5

26) 115 cm

27) 81 cm²

28) $(4y+24)$ marbles

29)

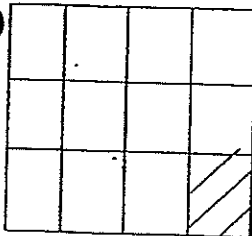

30) 6

Paper 2

1) $\frac{39}{100}$, $\frac{2}{5}$, $\frac{51}{125}$, $\frac{21}{50}$

2) $100 - 60 = 40\%$

$\frac{2}{5} \rightarrow 40\% \rightarrow 400$

$\frac{5}{5} \rightarrow 100\% \rightarrow 400/40 \times 100 = \1000

3)

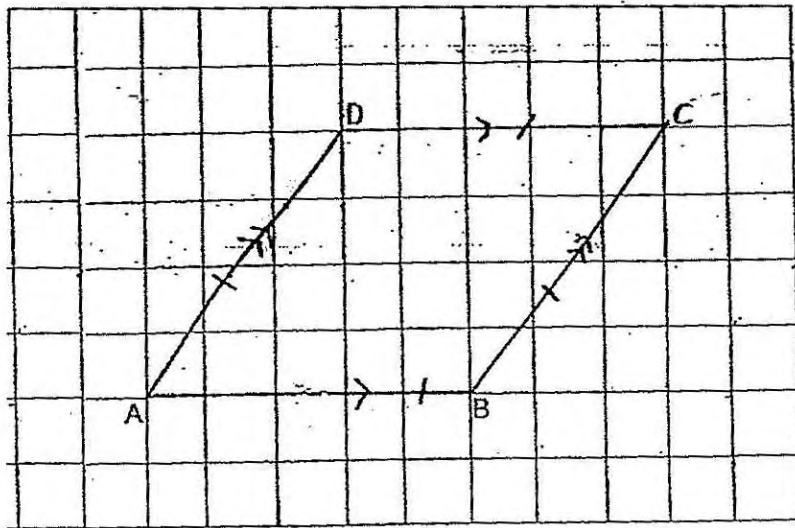

4) $J + K \rightarrow 160$

$$160 - (12n + 6)$$

$$= 160 - 12n - 6$$

$$= 160 - 6 - 12n$$

$$= 154 - 12n$$

$$2u \rightarrow 154 - (12 \times 7) = 70$$

$$1u \rightarrow 70 \div 2 = \$35$$

5) $24 \times 257 = 6168$

$$6168 \div 20 = 308 \text{ R } 8$$

Ans: 8 oranges

6) a) $3m \text{ pens} + 4 \text{ markers} \rightarrow 38$

$$3m \times 2 = 6m$$

$$(38 - 6m/4)$$

b) $38 - (6 \times 4) = 14$

$$14 \div 4 = \$3.5$$

7) $10 \times 2 = 20$

$$20 - 4 = 16$$

Wei ming $\rightarrow 16 \div 4 = 4$

Win lose $\rightarrow 10 - 4 = 6 \text{ rounds}$

8) $55^\circ - 30^\circ = 25^\circ$

$$180^\circ - 55^\circ - 55^\circ = 70^\circ$$

$$180^\circ - 70^\circ - 30^\circ = 80^\circ$$

9) C : W

4u : 7p

-1u : -5p

3u : 2P

1 : 2

3u x 2 = 6u

6u → 2p

3u → 1p

21u → 7p

21 - 4 = 17

17u → 68

1u → 68 ÷ 17 = 4

21 + 4 = 25

25u → 25 x 4 = 100 muffins

10)a) $3/20 \times 50000 = 7500$

b) $1 - 2/5 - 1/4 - 3/30 = 1/5$

11)a) $2/3 \rightarrow 20 \times 20 \times 16 = 6400$

$3/3 \rightarrow 6400 \div 2 \times 3 = 9600$

b) $9600 \div 20 \div 16 = 30$

$30 - 1.5 = 28.5$

$28.5 \times 20 \times 16 = 9120 \text{ cm}^3$

$9120 - 6400 = 2720 \text{ cm}^3$

12)a) $5/8 \times 4/5 = 1/2 \rightarrow \text{Left}$

b) $4/5 \times 3/8 = 3/10 \rightarrow \text{Golf set}$

$1/2 - 3/10 = 1/5$

(W) $1/5 \rightarrow 1492$

$5/8 \rightarrow 1492 \times 5 = 7460$

GS → $7460 \times 3/10 = 2238$

Diff → $2238 - 1492 = \$746$

13) $6s + 11v = 1471.35$

$9s + 16v \rightarrow \$$

$1v + 172.55 \rightarrow 6s$

$6v + 1035.3 \rightarrow 6s$

$6v + 1035.3 + 11v \rightarrow 1471.35$

$17v \rightarrow 1471.35 - 1035.3 = 436.05$

$1v \rightarrow 436.05 \div 17 = 25.65$

$16v \rightarrow 16 \times 25.65 = 410.4$

$9s \rightarrow 9v + (172.55 \times 9) = 9v + 1552.95$

$9s \rightarrow 25.65 \times 9 + 1552.95 = 1783.8$

$410.4 + 1783.8 = \$194.20$

14)a) $35u - 3402 = 12u - 596$
 $35u - 12u = 3402 - 596$
 $23u = 2806$
 $1u = 2806 \div 23 = 122$
 $5u = 5 \times 122 = 610$ cookies
b) C: $5u - 486 \rightarrow 610 - 486 = 124$
T: $3u - 149 \rightarrow (3 \times 122) - 149 = 217$
Diff $\rightarrow 217 - 124 = 93$ more

15)a) $2u \times 18 + 23u \times 10 = 4522$
 $36u + 230u = 4522$
 $266u = 4522$
 $1u = 4522 \div 266 = 17$
T $\rightarrow 2u = 2 \times 17 = 34$
(T)\$ $\rightarrow 34 \times 18 = \612
b) pupils $\rightarrow 23 \times 17 = 391$
 $391 \div 6 = 65$ R1

16)a) $3.14 \times 10 \times 10 \div 4 = 78.5$
 $10 \times 10 = 100$
 $100 - 78.5 = 21.5$
 $21.5 \times 2 = 43$
 $100 - 43 = 57$
 $4 \times 57 = 228$
 $314 + 228 = 542$ cm²
b) $2 \times 3.14 \times 10 = 62.8$
 $62.8 \times 2 = 125.6$
 $62.8 + 125.6 + (8 \times 10) = 268.4$ cm

17) 30 min $\rightarrow 30 \times 300 = 9000$
Distance $\rightarrow 9000 + 9000 + 1800 = 19800$
B : 30 min $\rightarrow 9000 + 1800 = 10800$
(speed) 1 min $\rightarrow 10800 \div 30 = 360$
(B) time $\rightarrow 19800 \div 360 = 55$ (in min)

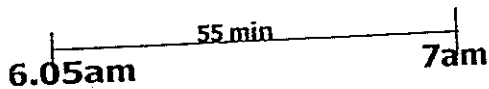

Ans: 6.05 am

18)a) $20 \times 10 \times 2 = 400$
 $16 \times 2 \times 10 = 320$
 $320 + 400 = 720$ cm³
b) $720 \times 8 = 5760$
 $5616 \div 720 = 7$ R 576
H $\rightarrow 2 + 2 = 4$
 $4 \times 7 = 28$

Left $\rightarrow 576 - 400 = 176$
 $28 + 2 = 30$
 $176 \div 16 \div 10 = 1.1$
 $30 + 1.1 = 31.1$ cm