

Index
No.

						-	
--	--	--	--	--	--	---	--

PEI CHUN PUBLIC SCHOOL
PRELIMINARY EXAMINATION, 2018

MATHEMATICS
PAPER 1
(BOOKLET A)

Additional materials: Optical Answer Sheet (OAS) Total Time For Booklets A & B : 1 h

Name : _____ ()

Class : Primary 6 / _____

Date : 1 August 2018

INSTRUCTIONS TO CANDIDATES

DO NOT OPEN THIS BOOKLET UNTIL YOU ARE TOLD TO DO SO.

FOLLOW ALL INSTRUCTIONS CAREFULLY.

ANSWER ALL THE QUESTIONS.

SHADE YOUR ANSWERS IN THE OPTICAL ANSWER SHEET (OAS) PROVIDED.

YOU ARE **NOT** ALLOWED TO USE A CALCULATOR.

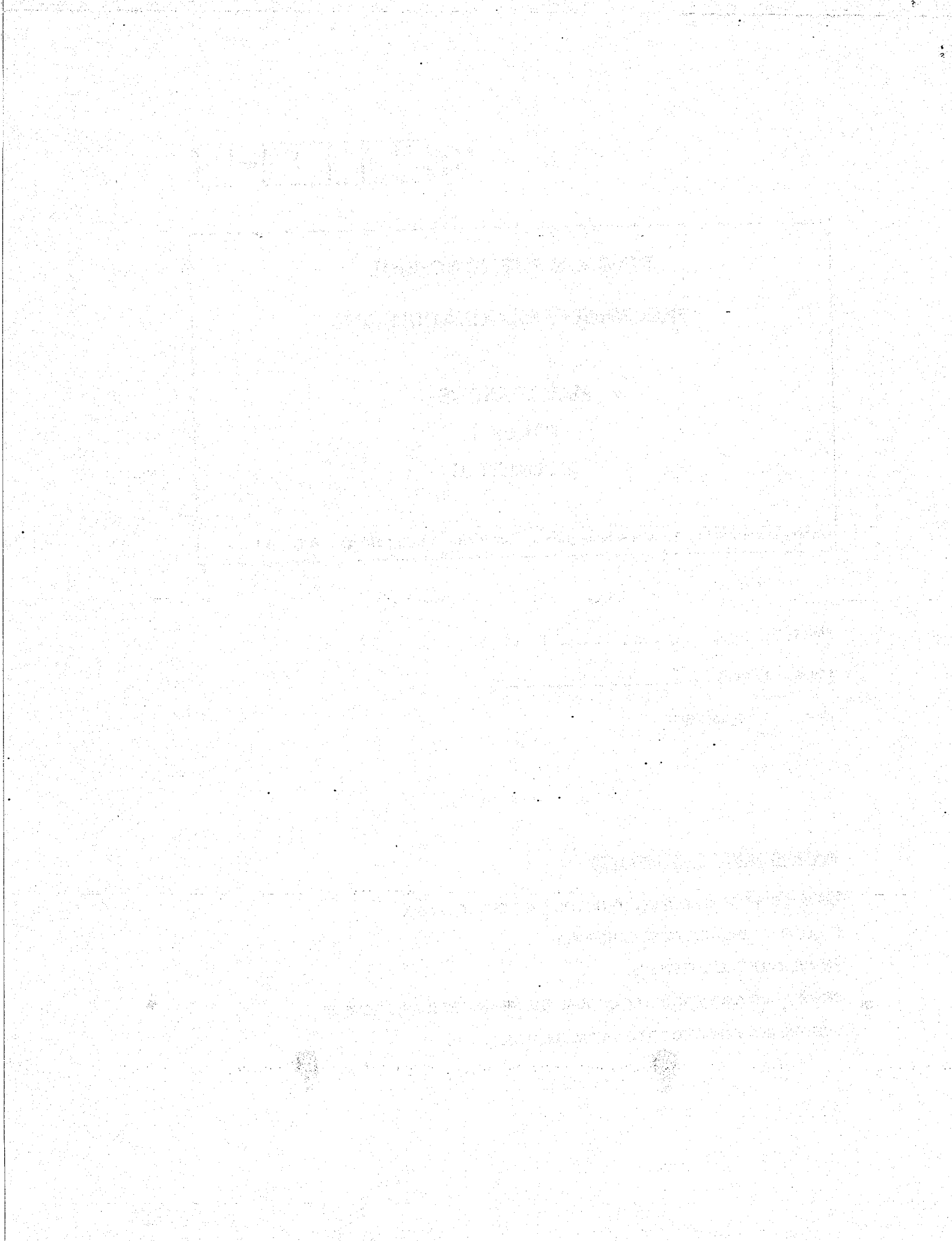

Questions 1 to 10 carry 1 mark each. Questions 11 to 15 carry 2 marks each.
For each question, four options are given. One of them is the correct answer.
Make your choice (1, 2, 3 or 4). Shade the correct oval (1, 2, 3 or 4) on the
Optical Answer Sheet. (20 marks)

1. Which of the following is eight hundred and five thousand and twenty-one in figures?

- (1) 85 021
- (2) 805 021
- (3) 850 021
- (4) 8 005 021

2. Round 299 542 to the nearest thousand.

- (1) 290 000
- (2) 299 500
- (3) 300 000
- (4) 300 542

3. What is the value of 500×80 ?

- (1) 40
- (2) 400
- (3) 4000
- (4) 40 000

4. Which of the following is the same as 9.04 l?

- (1) 904 cm³
- (2) 9004 cm³
- (3) 9040 cm³
- (4) 9400 cm³

5. Which of the following is the smallest?

- (1) 0.6
- (2) 0.31
- (3) 0.079
- (4) 0.102

6. Which of the marked angles in the figure below is greater than a right angle?

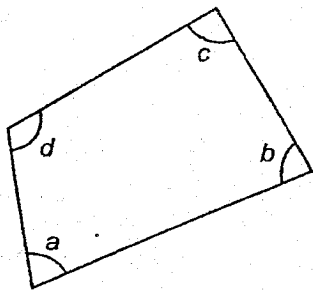

- (1) $\angle a$
- (2) $\angle b$
- (3) $\angle c$
- (4) $\angle d$

7. In the figure below, AB and CD are straight lines.

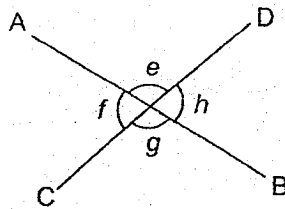

Which of the following statements is true?

- (1) $\angle e = \angle g$
- (2) $\angle f = \angle e$
- (3) $\angle f + \angle h = 180^\circ$
- (4) $\angle e + \angle g = 180^\circ$

8. The figure below shows an isosceles triangle WXY . $\angle YWX = 58^\circ$.

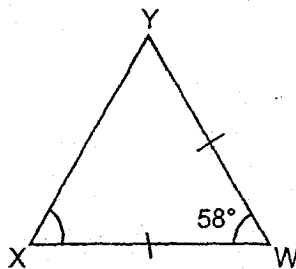

Find $\angle WXY$.

- (1) 64°
 - (2) 61°
 - (3) 58°
 - (4) 32°
9. Simplify the expression $9y + 7 - 5y + 3$.
- (1) $14y + 4$
 - (2) $4y - 10$
 - (3) $4y + 4$
 - (4) $4y + 10$
10. Express 4.2 as a percentage.

- (1) 4.2%
- (2) 42%
- (3) 420%
- (4) 4200%

11. Which of the following is not a symmetric figure?

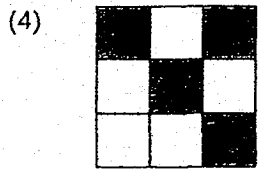
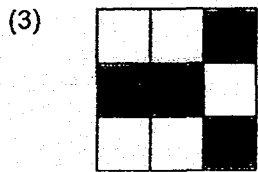
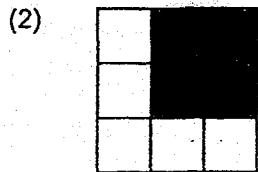
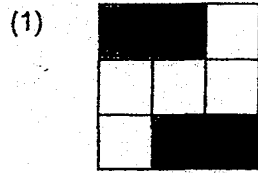

12. Suzy had some apples. $\frac{2}{5}$ of them were green and the rest were red. She sold all the green apples and $\frac{1}{4}$ of the red apples. What fraction of the apples were sold?

(1) $\frac{3}{20}$

(2) $\frac{11}{20}$

(3) $\frac{13}{20}$

(4) $\frac{14}{20}$

13. Mrs Yong wanted to pack 72 oranges and 96 apples into as many bags as possible with no remainder. She packed the same number of fruit in each bag. The number of apples in each bag was the same. How many oranges were there in each bag?

- (1) 24
- (2) 7
- (3) 3
- (4) 4

14. The figure below shows a pyramid.

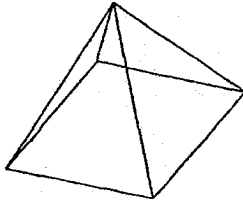

Which of the following is **not** a net of the pyramid?

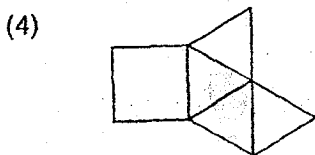
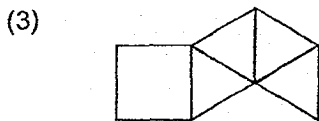
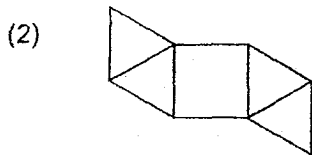
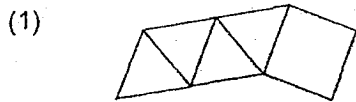

15. The diagrams below show three different views of a solid that is made up of 12 unit cubes.

Front View

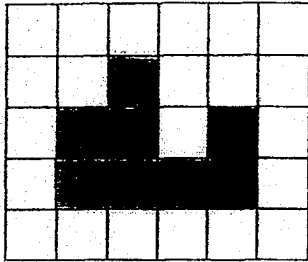

Top View

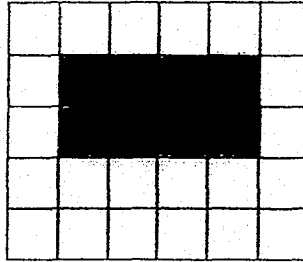

Side View

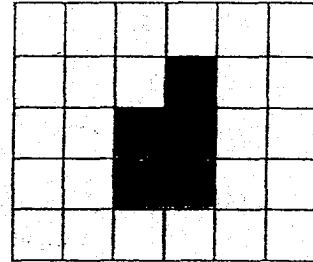

Which of the following solid matches the three views?

(1)

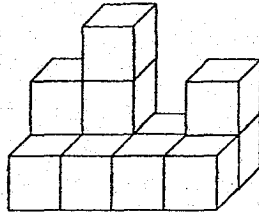

(2)

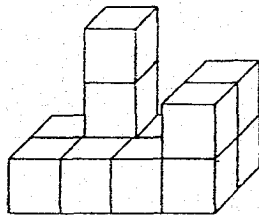

(3)

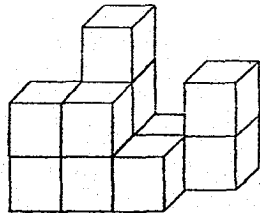

(4)

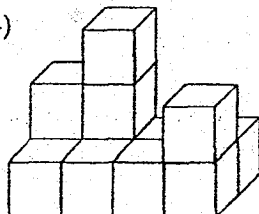

Questions 16 to 20 carry 1 mark each. Write your answers in the spaces provided.
For questions which require units, give your answers in the units stated. (5 marks)

Do not write
in this space

16. What is the missing number in the box?

$$6 : 15 = \boxed{?} : 55$$

Answer: _____

17. Find the value of $35 - 2 \times (3 + 4) + 6$.

Answer: _____

18. Find the value of $\frac{3}{7} \div 9$.

Answer: _____

19. Find the value of $\frac{42 - 3y}{6} + 8$ when $y = 4$.

Answer: _____

SCORE

20. Find the volume of the cube shown below.

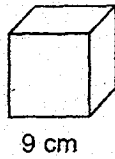

Answer: _____ cm^3

Do not write
in this space

Questions 21 to 30 carry 2 marks each. Show your working clearly and write your answers in the spaces provided. For questions which require units, give your answers in the units stated. (20 marks)

21. Find the value of

(a) 20.7×1000

(b) $8.06 \div 20$

Answer: (a) _____

(b) _____

22. The base of a rectangular container is 60 cm long and 20 cm wide. Peter poured $36\,000 \text{ cm}^3$ of water into the container. What is the height of the water level?

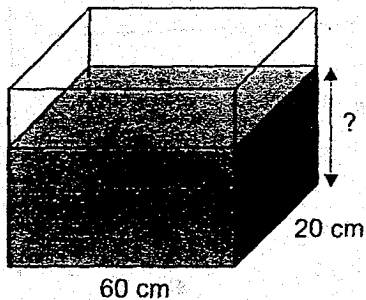

Answer: _____ cm

SCORE

23. Seven landmarks are shown in the square grid below.

Do not write in this space

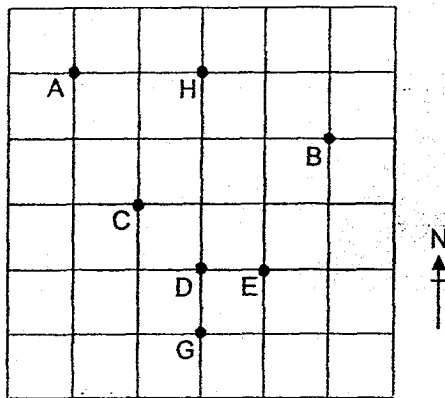

- (a) In which direction is A from E?
- (b) A treasure is buried under one of the landmarks. The treasure is south of H and south-west of B. Under which landmark is the treasure buried?

Answer: (a) _____

(b) _____

24. The ratio of the number of boys to the number of girls in a hall is 2 : 7. There are 180 children. Find the difference between the number of boys and the number of girls.

Answer: _____

SCORE

25. The figure below shows a rectangle and a triangle. What is the area of the shaded triangle?

Do not write
in this space

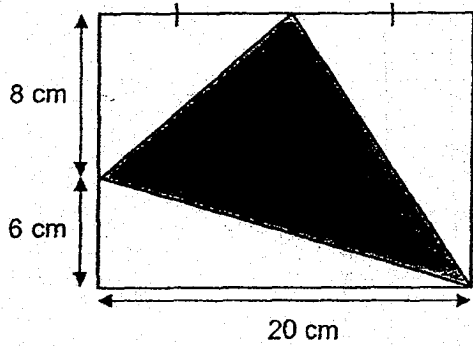

Answer: _____ cm^2

26. ABCD is a trapezium. $\angle DAB = 70^\circ$. $\angle ADC = 106^\circ$.

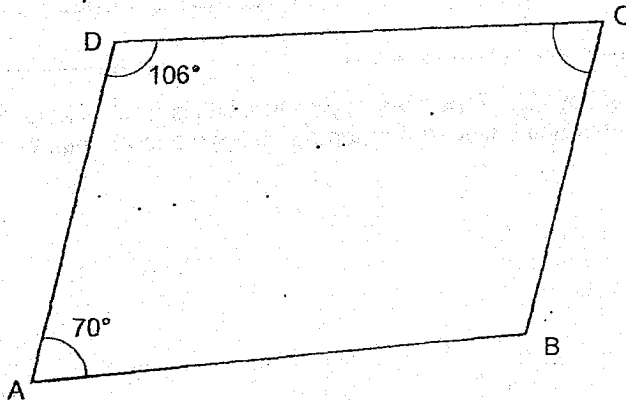

- (a) Name the pair of parallel sides of the trapezium.
(b) Find $\angle BCD$.

Answer: (a) _____

(b) _____ $^\circ$

SCORE

27. A table with 4 columns is filled with numbers in a certain pattern. The first 4 rows of the table are shown below.

	Column A	Column B	Column C	Column D
Row 1	1	2	3	4
Row 2	8	7	6	5
Row 3	9	10	11	12
Row 4	16	15	14	13
⋮	⋮	⋮	⋮	⋮

In which row and column will the number 295 appear?

Answer: Row: _____

Column: _____

-
28. One machine took 80 minutes while another took 100 minutes to print the same number of copies of a newsletter. In 80 minutes, the faster machine printed 360 more copies of the newsletter than the slower one. What was the total number of copies printed by the two machines?

Answer: _____

Do not write
in this space

SCORE

29. Siva saves \$3 a day during weekdays and \$6 a day on Saturday and Sunday. He started saving on Friday, 8 June. How many days did he take to save \$69?

Do not write
in this space

Answer: _____

30. The bar graph below shows the height of 5 boys.

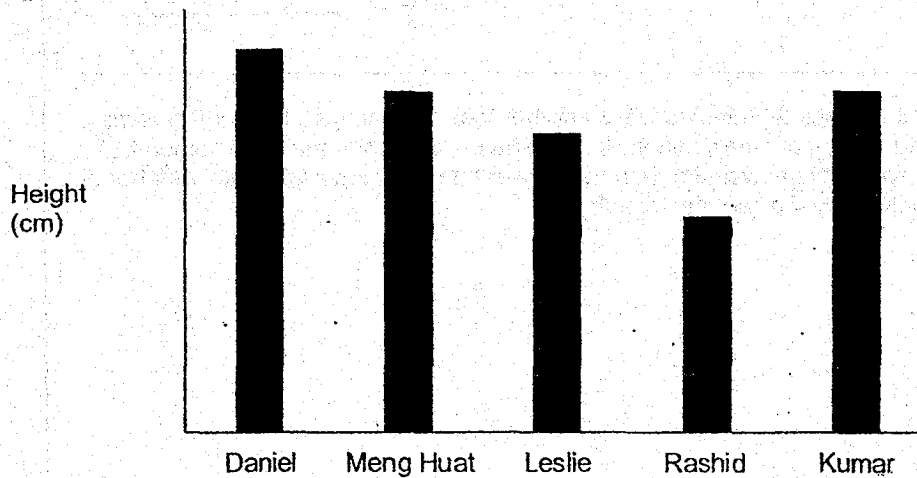

Based on the information above, put a tick (✓) in the correct box.

	True	False	Not possible to tell
(a) Leslie's height is less than Rashid's height.			
(b) The average height of the 5 boys is more than Rashid's height but less than Daniel's height.			

End of Paper

Index No.

--	--	--	--	--	--	--	--	--	--

 -

--

PEI CHUN PUBLIC SCHOOL
PRELIMINARY EXAMINATION, 2018

MATHEMATICS
PAPER 2

Time: 1 h 30 min

Name : _____ ()
Class : Primary 6 / _____
Date : 1 August 2018
Parent's Signature: _____

Paper 1 (Booklet A)	20
Paper 1 (Booklet B)	25
Paper 2	55
TOTAL	100

INSTRUCTIONS TO CANDIDATES

- DO NOT OPEN THIS BOOKLET UNTIL YOU ARE TOLD TO DO SO.
- FOLLOW ALL INSTRUCTIONS CAREFULLY.
- ANSWER ALL QUESTIONS.
- SHOW YOUR WORKING CLEARLY AS MARKS ARE AWARDED FOR CORRECT WORKING.
- WRITE YOUR ANSWERS IN THIS BOOKLET.
- YOU ARE ALLOWED TO USE A CALCULATOR.

Questions 1 to 5 carry 2 marks each. Show your working clearly and write your answers in the spaces provided. For questions which require units, give your answers in the units stated. (10 marks)

Do n
in thi

1. There are 4032 people at a concert hall. $\frac{2}{7}$ of the people are females.
How many females are there in the concert hall?

Answer: _____

2. The average height of 4 boys is 1.36 m. The height of one of the boys is 1.45 m.
What is the average height of the other 3 boys?

Answer: _____ m

SCORE

3. There were 13 bookshelves each holding the same number of books. 1 bookshelf was removed and the books on the shelf were placed on the remaining 12 shelves. Because of this, the number of books on each remaining shelf increased by 8. What was the total number of books in the 13 bookshelves at first?

Do not write
in this space

Answer: _____

-
4. The breadth of a rectangle is b cm. The length of the rectangle is 3 times its breadth. What is the perimeter of the rectangle? Express your answer in terms of b .

Answer: _____ cm

SCORE



5. In the figure below, ABCD and BECF are rectangles. The length of CE is 20 cm, the length of BE is 15 cm and the length of AB is 12 cm. What is the length of AD?

Do not
in this

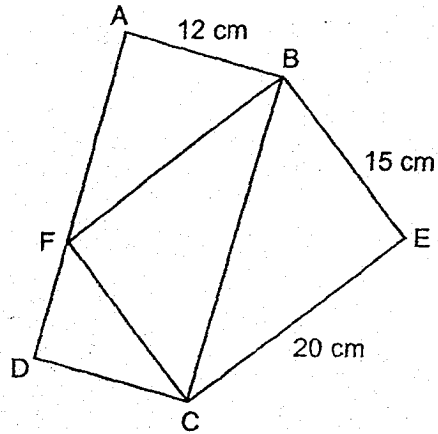

Answer: _____ cm

SCORE

For questions 6 to 17, show your working clearly and write your answers in the spaces provided. The number of marks available is shown in brackets [] at the end of each question or part-question. (45 marks)

Do not write
in this space

-
6. Zainal and Marc saved a total of \$193. Suresh and Marc saved a total of \$100. Zainal saved 4 times as much money as Suresh. How much did Marc save?

Answer: _____ [3]

-
7. The mass of a watermelon is 640 g more than the mass of a durian. The mass of a jackfruit is twice the mass of a watermelon. The total mass of the three fruits is 8.72 kg. What is the mass of the jackfruit?

Answer: _____ [3]

SCORE

8. In the square grid below, QR is a side of a trapezium.

(a) Measure the length of QR.

(b) Draw a trapezium PQRS in the square grid such that:

(i) $\angle RQP$ is a right angle;

Do not write
in this space

8(b)

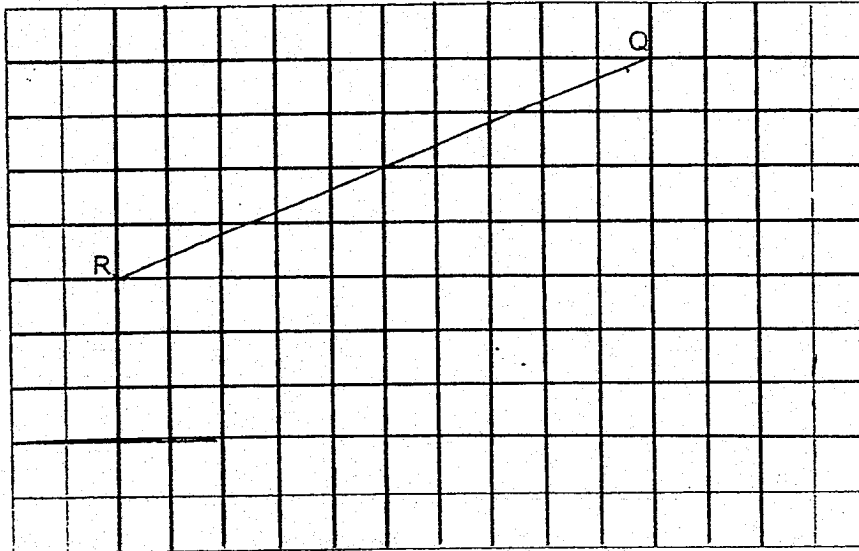

Answer: (a) _____ [1]

9. At first, the ratio of Leon's savings to Michael's savings was 9 : 7. After each of them donated \$680 to charity, the ratio of Leon's savings to Michael's savings became 5 : 2. What was Michael's savings at first?

Answer _____ [3]

SCORE

--

10. Kai Ling wanted to buy a present for her parents with her savings. She started saving from the beginning of January. The line graph below shows her savings at the end of each month.

Do not write in this space

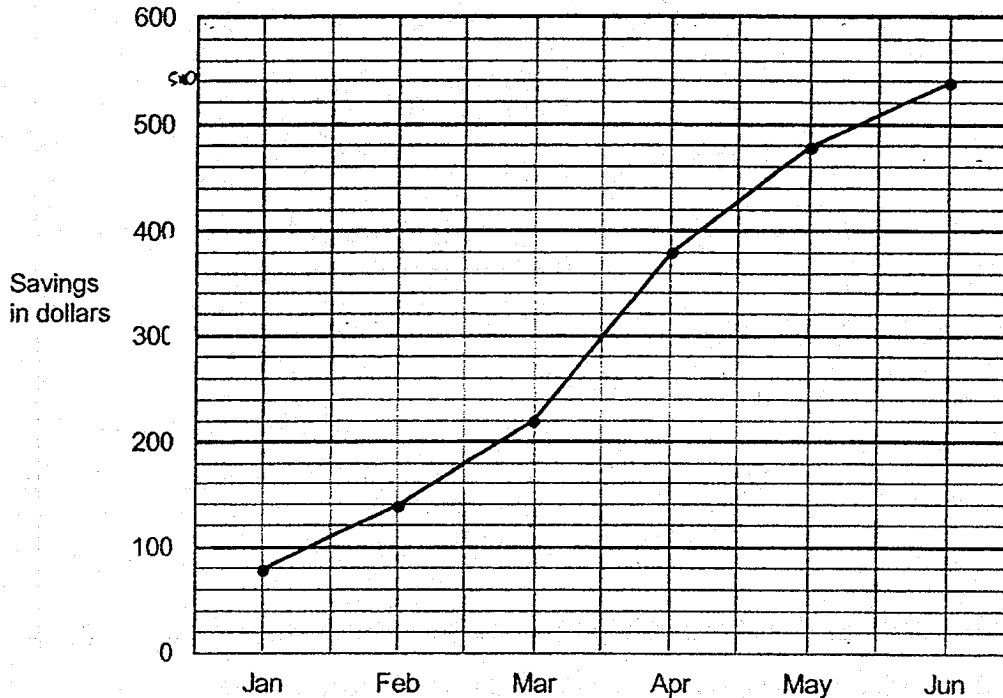

- (a) In which month did Kai Ling save the most? How much did she save that month?
- (b) At the end of June, Kai Ling realised she had not saved enough for the present. She only managed to save $\frac{3}{4}$ of the amount she needed. What was the amount she needed for the present?

Answer: (a) Month : _____ [1]

Amount : _____ [1]

(b) _____ [2]

SCORE

11. There are 360 Primary 6 pupils in a primary school. The pie chart shows the type of books the Primary 6 pupils like to read. 64 pupils like to read Science magazines.

Do not
in this s

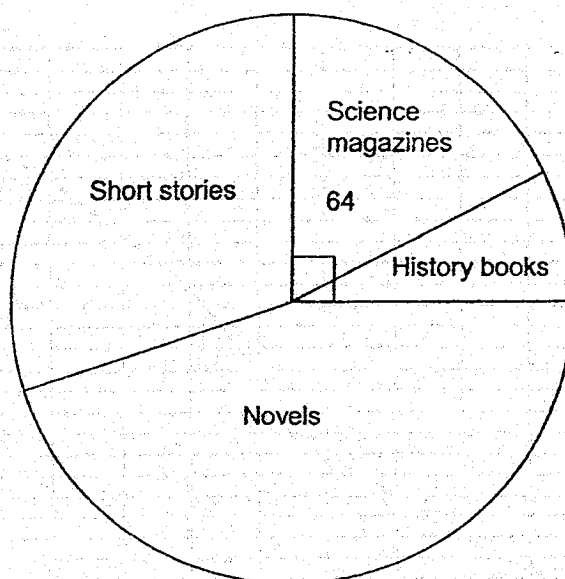

- (a) What fraction of the pupils like to read short stories or novels?
- (b) What percentage of the pupils like to read Science magazines?
- (c) The ratio of the number of pupils who like to read short stories to the number of pupils who like to read novels is 2 : 3.
What percentage of the pupils like to read novels?

Answer: (a) _____ [1]

(b) _____ [1]

(c) _____ [2]

SCORE

12. At a shop, a mobile phone was sold at 40% the price of a television. Both items were sold at a 20% discount. Janet paid \$2016 for both items after the discount. What was the usual price of the television?

Do not write
in this space

Answer: _____ [3]

SCORE

--

13. Two rectangular tanks are shown below.

Do not write
in this space

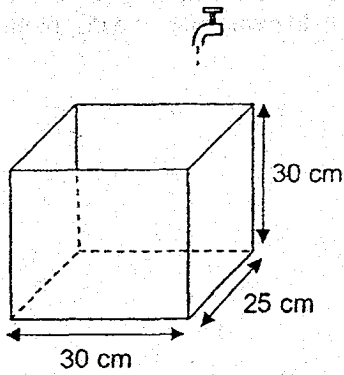

Tank A

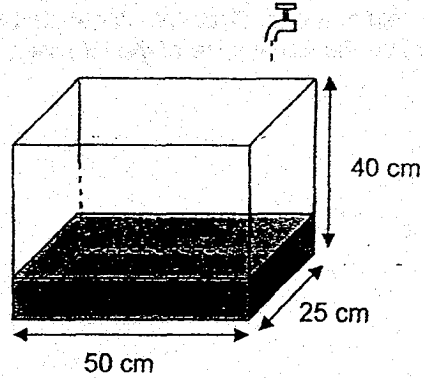

Tank B

At first, Tank A was empty and $\frac{1}{4}$ of Tank B was filled with water. Both taps were turned on at the same time and water from both taps flowed at the same rate of 1.5 litres per minute.

How long did it take for the height of water to be the same in both tanks?
(1 litres = 1000 cm³)

Ans _____ [3]

SCORE

14. The figure below is not drawn to scale. $ABFE$ and ACG are straight lines. $BCDE$ is a square and $CFDG$ is a rhombus. $\angle BAC = 63^\circ$.

- (a) Find $\angle ACB$.
 (b) Find $\angle CGD$.

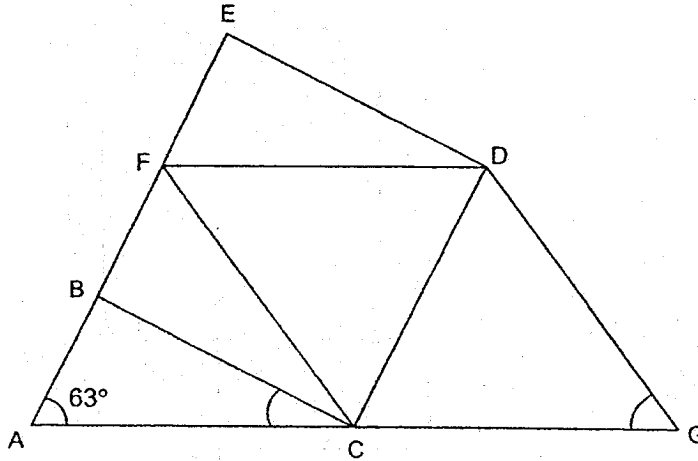

Do not write in this space

Answer: (a) _____ [2]

(b) _____ [3]

SCORE

15. The figure shows a table mat. The outside edge of the mat is formed by 12 semicircles and 4 quarter circles, each of radius 10 cm.

- (a) Find the perimeter of the mat.
(b) Find the area of the mat.

Take $\pi = 3.14$.

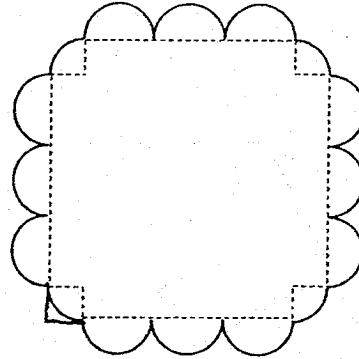

Do not write
in this space

Answer: (a) _____ [2]

(b) _____ [3]

SCORE

16. Raja and Greg took part in a walkathon which started at 7.20 a.m. Raja's average speed was 30 m/min faster than Greg. When Raja completed the walkathon in 40 minutes, Greg had only walked $\frac{5}{6}$ of the distance.

Do not write
in this space

- (a) What time was it when Greg completed the walkathon?
- (b) Find Raja's average speed for the walkathon in m/min.

Answer: (a) _____ [2]

(b) _____ [2]

SCORE

--

17. Lee Peng and Janice had some red and yellow ribbons. $\frac{4}{9}$ of Lee Peng's ribbons were red, while $\frac{1}{3}$ of Janice's ribbons were red. Lee Peng gave $\frac{3}{4}$ of her red ribbons to Janice.

In the end, Lee Peng had 126 ribbons left and $\frac{6}{11}$ of Janice's ribbons were red.

- (a) How many red ribbons did Lee Peng give Janice?
(b) How many ribbons did Janice have in the end?

Do not write
in this space

Answer: (a) _____ [2]

(b) _____ [3]

End of Paper

Set by : Mrs Agnes Chua, Mr Tan Keng Hock and Mr Stanley Soh

SCORE

ANSWER KEY

YEAR : 2018
LEVEL : PRIMARY 6
SCHOOL : PEI CHUN PUBLIC
SUBJECT : MATHEMATICS
TERM : PRELIMINARY EXAMINATION

Paper 1

Q1	2	Q4	3	Q7	1	Q10	3	Q13	3
Q2	3	Q5	3	Q8	2	Q11	1	Q14	1
Q3	4	Q6	4	Q9	4	Q12	2	Q15	4

Q16 22

Q17 27

Q18 $\frac{1}{21}$

Q19 13

Q20 729 cm^3

Q21 (a) 20700

(b) 0.403

Q22 30 cm

Q23 (a) North-west

(b) D

Q24 100

Q25 110 cm^2

Q26 (a) DA and CB

(b) 74°

Q27 Row : 74
Column : 8

Q28 3600

Q29 17 days

Q30 (a) False

(b) True

Paper 2

Q1 $\frac{1}{7} \rightarrow 4032 \div 7 = 576$

Females $\rightarrow 576 \times 2 \Rightarrow$ 1152

Q2 Total $\rightarrow 1.36 \times 4 = 5.44$

3 boys $\rightarrow 5.44 - 1.45 = 3.99$

Average $\rightarrow 399 \div 3 \Rightarrow$ 1.33 m

Q3 1 shelf $\rightarrow 8 \times 12 = 96$

13 shelves $\rightarrow 96 \times 13 \Rightarrow$ 1248 books

Q4 Length $\rightarrow b \times 3 = 3b$

Perimeter $\rightarrow 3b + 3b + b + b \Rightarrow$ 8b cm

Q5 Area $\rightarrow 20 \times 15 = 300$

$300 \div 2 = 150$

$150 \times 2 = 300$

AD $\rightarrow 300 \div 12 \Rightarrow$ 25 cm

Solutions to Word Problems
Pei Chun Paper 2
P6 Mathematics SA2 2018

Show your working clearly in the space provided for each question and write your answers in the spaces provided.

6. Savings of Suresh and Marc = \$100 (1)
Savings of Zainal and Marc = \$193
Savings of 4 x Suresh and Marc = \$193 (2) Zainal savings=4x Suresh's
3 x (Suresh's savings) = 193 – 100 = 93 (3) = (2) – (1)
Suresh's savings = 93 ÷ 3 = \$31
Marc's savings = 100 – 31 = \$69

Ans: \$69

-
7. Let mass of durian = u
Mass of watermelon = $u + 640$
Mass of jackfruit = $(u + 640) \times 2 = 2u + 1280$
Total mass = $u + u + 640 + 2u + 1280 = 4u + 1920 = 8720$ g
 $4u = 8720 - 1920 = 6800$
 $u = 6800 \div 4 = 1700$
Mass of jackfruit = $2 \times 1700 + 1280 = 4680$ g = 4.68kg

Ans: 4.68kg

8. a)
Length of QR = 8.6 cm
b)

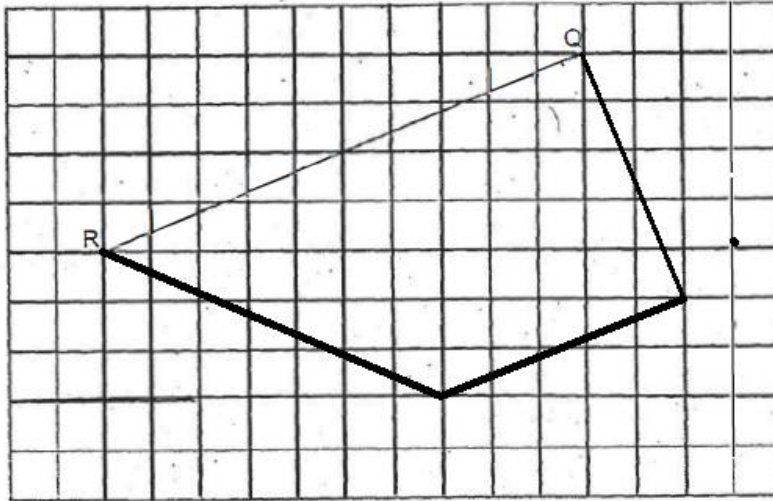

Ans: (a) 8.6 cm
(b) as shown

9. At first,
Ratio of Leon to Michael's savings $\rightarrow 9 : 7 \rightarrow 27u : 21u$
At the end,
Ratio of Leon to Michael's savings $\rightarrow 5 : 2 \rightarrow 10u : 4u$
 $27u - 10u = 17,$ $21u - 4u = 17u$
 $17u = 680$
 $u = 680 \div 17 = 40$
Michael's savings at first = $21u = 21 \times 40 = \$840$

Ans: \$840

10. a)

Month with the most savings = April

$$\text{Aprils savings} = 380 - 220 = \$160$$

b)

$$\text{Savings at end of June} = \$540 \rightarrow \frac{3}{4}$$

$$\frac{1}{4} \rightarrow \$180$$

$$\text{Total needed for present} = 540 + 180 = \$720$$

Ans: (a) April, \$160

(b) \$720

11. a)

$$\text{Fraction that like short stories or novels} = 1 - \frac{1}{4} = \frac{3}{4}$$

b)

$$\text{Percentage that like science magazines} = \frac{64}{360} \times 100 = 17.78\%$$

c)

$$\text{Percentage who like novels} = \frac{3}{5} \times 75\% = 45\%$$

Ans: (a) $\frac{3}{4}$

(b) 17.78%

(c) 45%

12. Let price of television = u
Undiscounted price of mobile and TV = $1.4 \times u = 1.4u$
Discounted price of mobile and TV = $0.8 \times 1.4u = 1.12u = 2016$
Usual price of TV = $u = 2016 \div 1.12 = \$1800$

Ans: \$1800

13. Let t = time in minutes after Taps were turn on.
Base area of Tank A = $25 \times 30 = 750$
Base area of Tank B = $25 \times 50 = 1250$
Rate of height increase of Tank A = $1500 \div 750 = 2 \text{ cm / min}$
Rate of height increase of Tank B = $1500 \div 1250 = 1.2 \text{ cm / min}$
Water height of Tank B at first = $\frac{1}{4} \times 40 = 10\text{cm}$
Water height of Tank B = $10 + 1.2 t$
Water height of Tank A = $2t$
 $2t = 10 + 1.2t$
 $0.8t = 10$
 $t = 10 \div 0.8 = 12.5 \text{ min}$

Ans: 12.5 min

14. a)

$$\angle ACB = 90 - 63 = 27^\circ$$

b)

$$\angle DCG = 180 - 90 - 27 = 63^\circ$$

$$\angle CGD = 180 - 63 - 63 = 54^\circ$$

Ans: (a) 27°

(b) 54°

15. a)

Diameter = 20 cm

Perimeter of 12 semi-circles & 4 quadrants = $7 \times \pi \times 20 = 140\pi = 439.6$ cm

b)

Area of 12 semi-circles & 4 quadrants = $7 \times \pi \times 10 \times 10 = 2198$ cm²

Area of square minus 4 corners = $80 \times 80 - 4 \times 10 \times 10 = 6000$ cm²

Area of mat = $2198 + 6000 = 8198$ cm²

Ans: (a) 439.6 cm
(b) 8198 cm²

16. a)

$$\text{Extra distance Raja walked} = 30 \times 40 = 1200 \text{ m}$$

$$\frac{1}{6} \text{ of distance} \rightarrow 1200$$

$$\frac{6}{6} \text{ of distance} \rightarrow 1200 \times 6 = 7200 \text{ m}$$

$$\text{Raja's speed} = 7200 \div 40 = 180 \text{ m / min}$$

$$\text{Greg's speed} = 180 - 30 = 150 \text{ m / min}$$

$$\text{Greg's distance} = 1200 \times 5 = 6000 \text{ m}$$

$$\text{Greg's time} = 7200 \div 150 = 48 \text{ min after 7:20} = 8.08 \text{ am}$$

b)

$$\text{Raja's average speed} = 180 \text{ m / min}$$

Ans: (a) 8.08 am

(b) 180 m / min

17. a)

$\frac{3}{4} \times \frac{4}{9} \rightarrow \frac{1}{3}$ Lee Peng's ribbon was given to Janice

$\frac{2}{3}$ of Lee Peng's ribbon = 126

$\frac{3}{3}$ of Lee Peng's ribbon = $126 \div 2 \times 3 = 189$

$\frac{1}{3}$ given to Janice $\rightarrow 126 \div 2 = 63$

b)

Ratio of Janice's red to yellow numbers at first $\rightarrow 1 : 2 \rightarrow 5u : 10u$

Ratio of Janice red to yellow numbers at last $\rightarrow 6 : 5 \rightarrow 12u : 10u$

$$12u - 5u = 7u = 63$$

$$22u = 63 \div 7 \times 22 = 198$$

Ans: (a) 63

(b) 198
