



HENRY PARK PRIMARY SCHOOL
2019 PRELIMINARY EXAMINATION
MATHEMATICS
PRIMARY 6

PAPER 1
(BOOKLET A)

Name: _____ ()

Parent's Signature

Class: Primary 6 _____

Marks:

Paper 1	Booklet A	20
	Booklet B	25
Paper 2		55
Total		100

Total Time for Booklets A and B: 1 hour

Do not turn over this page until you are told to do so.

Follow all instructions carefully.

Answer all questions.

Shade your answers in the Optical Answer Sheet (OAS) provided.

You are not allowed to use a calculator.

Questions 1 to 10 carry 1 mark each. Questions 11 to 15 carry 2 marks each.
For each question, four options are given. One of them is the correct answer.
Make your choice (1, 2, 3 or 4) and shade your answer in the Optical Answer Sheet.

(20 marks)

1 What does the digit 9 in 6.789 stand for?

- (1) 9 thousandths
- (2) 9 hundredths
- (3) 9 tens
- (4) 9 ones

2 Express $10k + 8 - 2k - 3$ in the simplest form.

- (1) $5k + 8$
- (2) $8k + 5$
- (3) $12k + 5$
- (4) $16k - 3$

3 In a class of 40 students, 15% of them do not wear spectacles.
How many students wear spectacles?

- (1) 6
- (2) 15
- (3) 25
- (4) 34

- 4 The figure shows a circle with diameter 22 cm.
Find the area of the circle in terms of π .

- (1) $11\pi \text{ cm}^2$
- (2) $22\pi \text{ cm}^2$
- (3) $121\pi \text{ cm}^2$
- (4) $282\pi \text{ cm}^2$

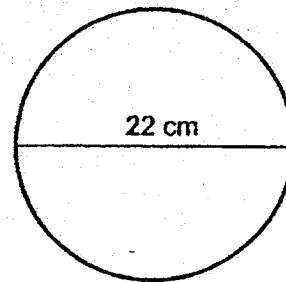

- 5 What is the perimeter of the figure shown below?

- (1) 26 cm
- (2) 39 cm
- (3) 43 cm
- (4) 44 cm

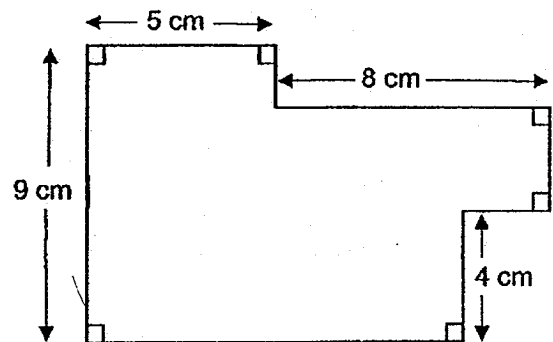

- 6 Four letters are shown on the square grid below.

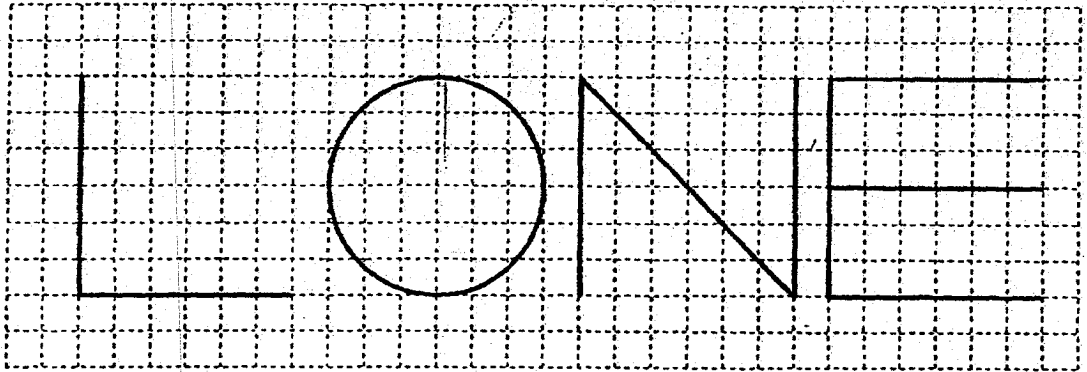

How many of the letters above is/are **NOT** symmetrical?

- (1) 1
(2) 2
(3) 3
(4) 4
- 7 A number when divided by 20 gives a remainder of 6. Which of the following can be added to the number to change it to a multiple of 8?

- (1) 10
(2) 7
(3) 5
(4) 4

Use the information below to answer Questions 8 and 9.

The line graph below shows the number of tourists who visited Country X from 2014 to 2018.

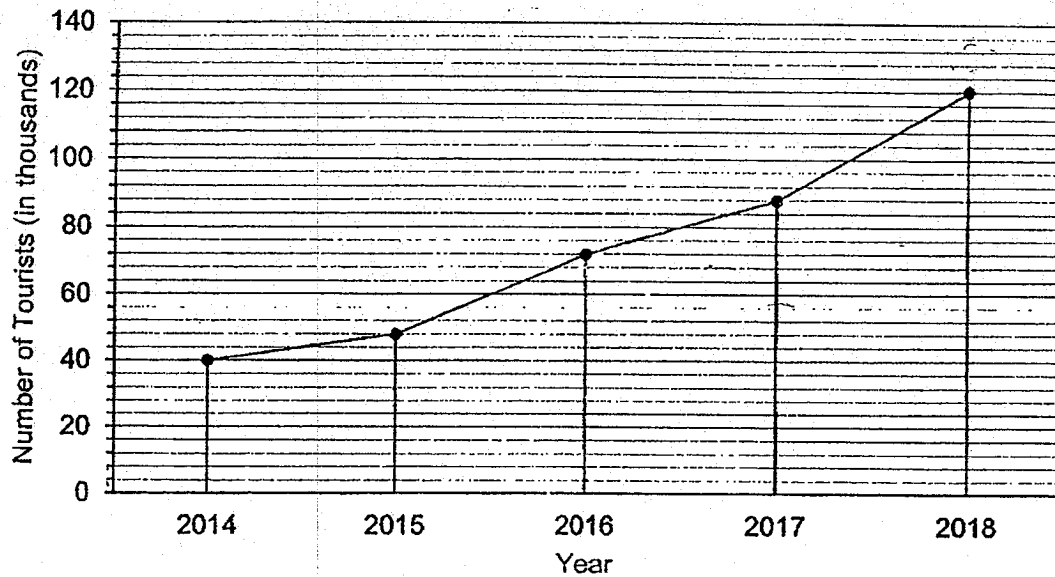

8 In which of the following periods did the number of tourists increase the most?

- (1) 2014 to 2015
- (2) 2015 to 2016
- (3) 2016 to 2017
- (4) 2017 to 2018

9 The number of tourists in 2019 was a 20% decrease from the number of tourists in 2018. How many tourists (in thousands) visited Country X in 2019?

- (1) 24
- (2) 90
- (3) 96
- (4) 100

- 10 The figure shows a cube. Two faces of the cube were shaded and the remaining faces were white.

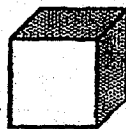

Which one of the following is NOT the net of the cube?

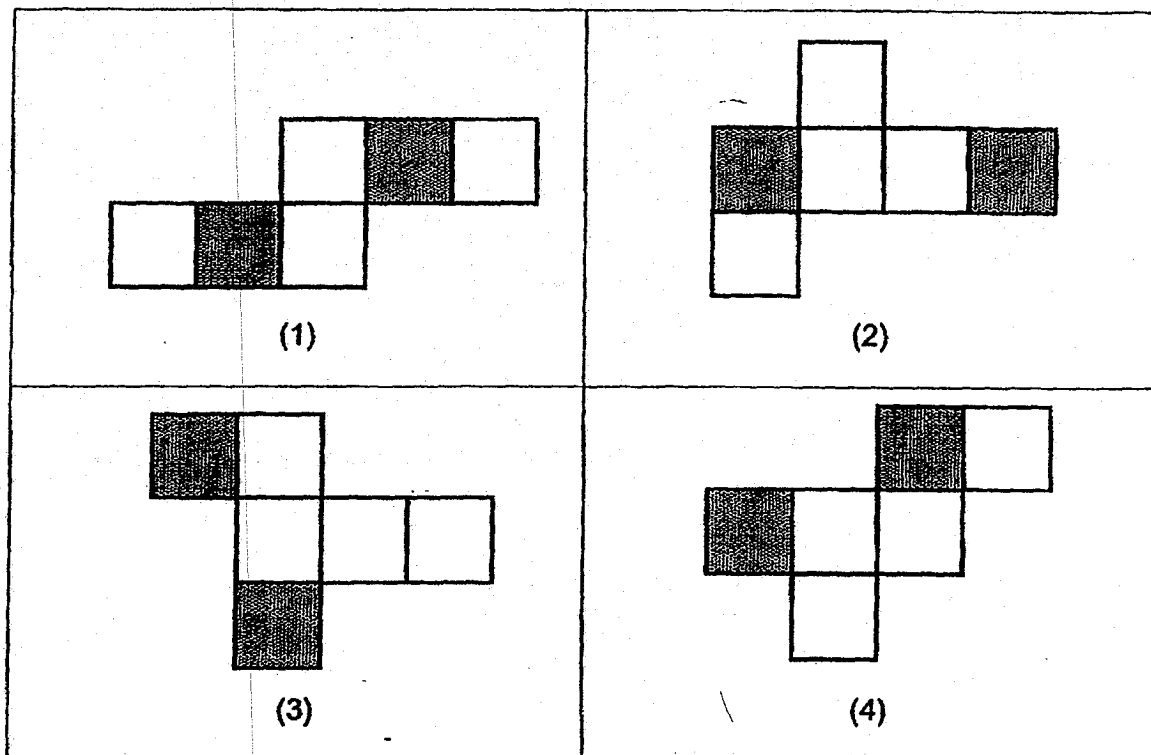

- 11 The table below shows the number of books read by 37 students in August. The number of students who read 5 books were not shown in the table.

Number of books	1	2	3	4	5
Number of students	10	8	7	9	?

How many students read at least 3 books in August?

- (1) 7
- (2) 16
- (3) 19
- (4) 25

- 12 Five attractions on a map of a town are shown in the square grid below.

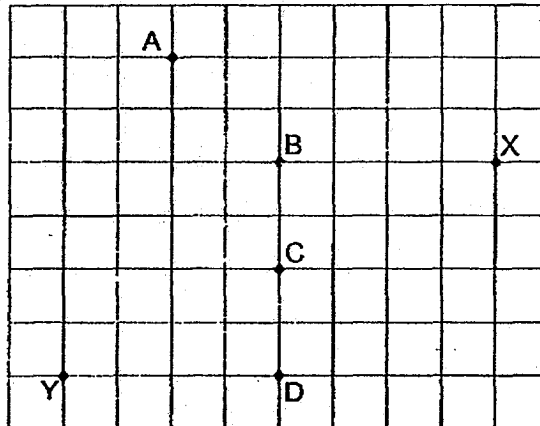

Mike is at one of the attractions. He is facing X. When he turns 135° clockwise, he faces Y. Which attraction is Mike at?

- (1) A
- (2) B
- (3) C
- (4) D

- 13 The bar graph shows the number of stamps from four different countries that Peter collected.

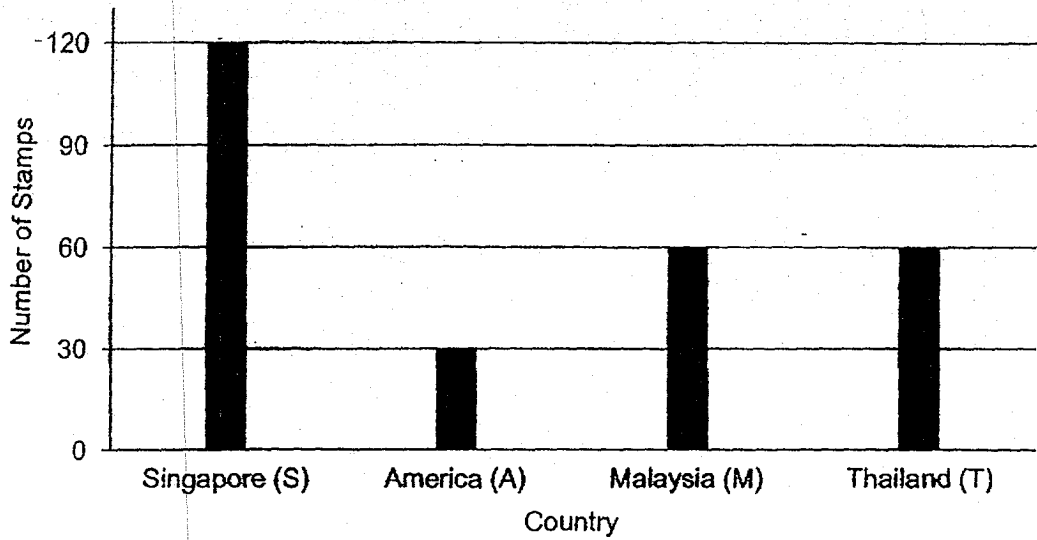

Which pie chart best represents the information in the bar graph?

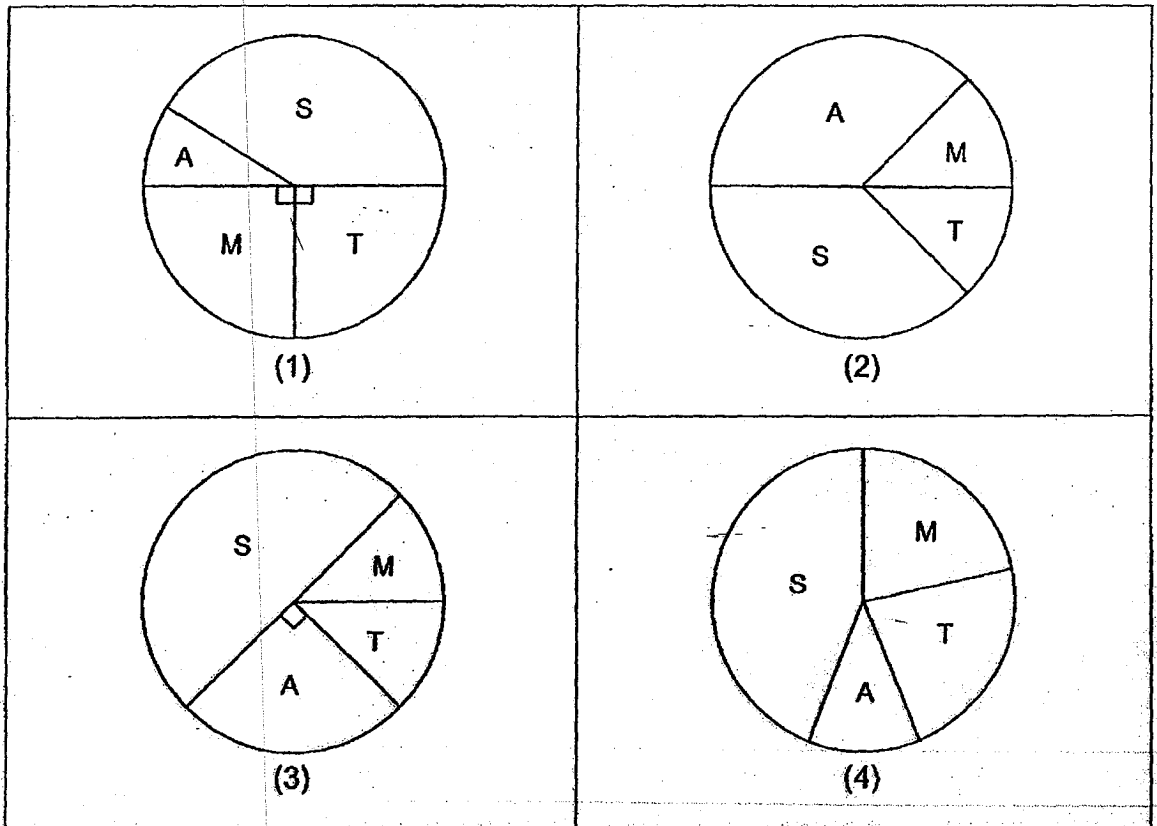

- 14 Calista and Dylan had the same number of stickers at first.
After Calista gave $\frac{1}{8}$ of her stickers to Dylan, she had 24 fewer stickers than Dylan.
How many stickers did Calista and Dylan have altogether?

- (1) 84
- (2) 96
- (3) 192
- (4) 216

- 15 Jane packed 408 cupcakes into a number of boxes.
Each box contained either 10 or 6 cupcakes.
Given that Jane used the least number of boxes to pack all the cupcakes, how many of the boxes contained 10 cupcakes each?

- (1) 25
- (2) 26
- (3) 39
- (4) 40

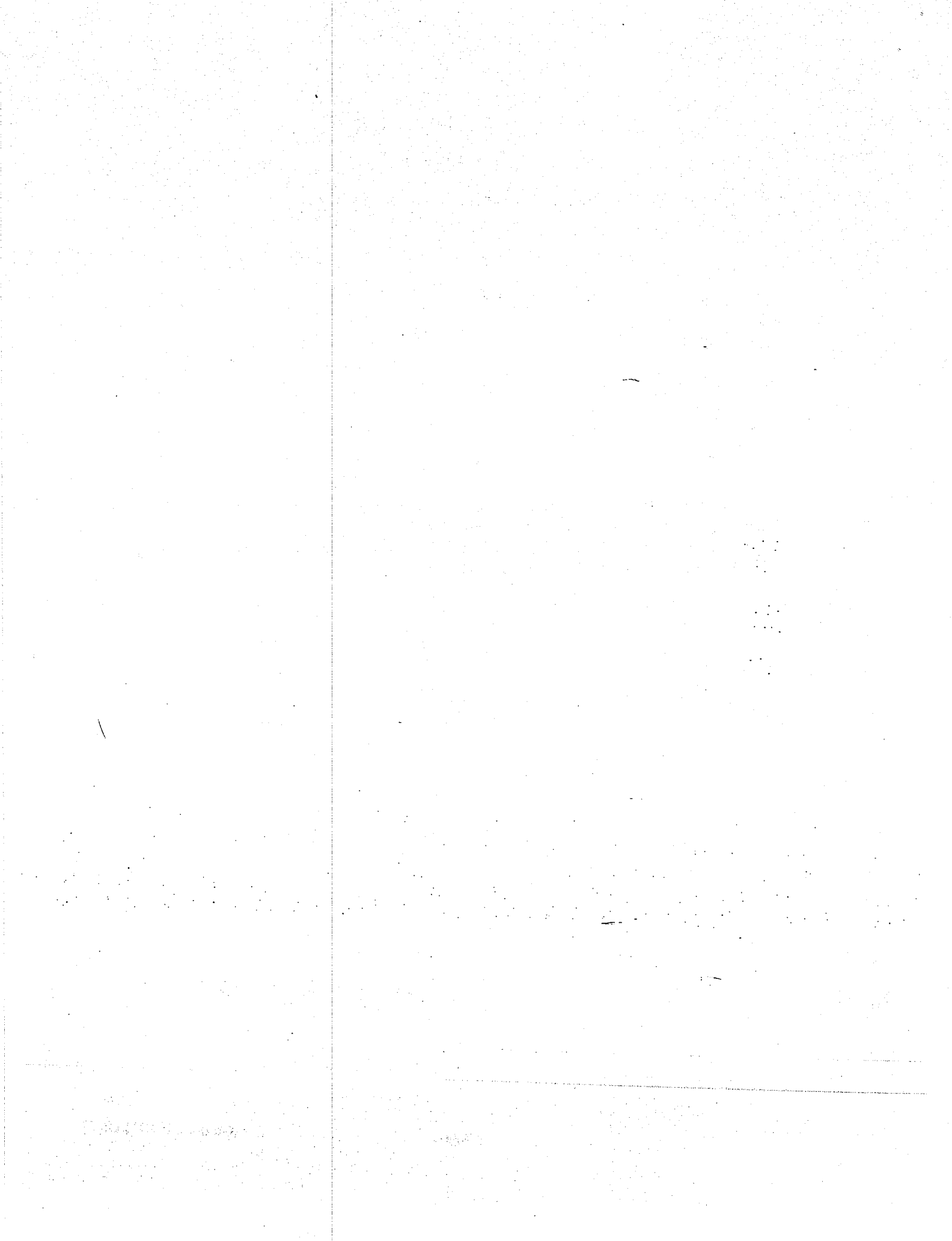



HENRY PARK PRIMARY SCHOOL
2019 PRELIMINARY EXAMINATION
MATHEMATICS
PRIMARY 6

PAPER 1
(BOOKLET B)

Name: _____ ()

Class: Primary 6 _____

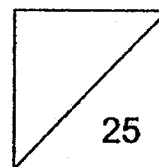

Total Time for Booklets A and B: 1 hour

Do not turn over this page until you are told to do so.

Follow all instructions carefully.

Answer all questions.

Write your answers in this booklet.

You are **not** allowed to use a calculator.

Questions 16 to 20 carry 1 mark each. Write your answers in the spaces provided.
For questions which require units, give your answers in the units stated.

(5 marks)

Do not write
in this space

16 Find the value of $108.5 + 1.99$

Ans: _____

17 Express $5\frac{2}{25}$ as a decimal.

Ans: _____

18 Find the value of $7a + \frac{28 - 2a}{5}$ when $a = 9$

Ans: _____

- 19 Janet thought of a number with 2 decimal places. When she rounded it to the nearest whole number, it became 37. What was the greatest possible number that Janet could have thought of?

Do not write
in this space

Ans: _____

- 20 Find the average of the following list of numbers:

Ans: _____

Questions 21 to 30 carry 2 marks each. Show your working clearly and write your answers in the spaces provided. For questions which require units, give your answers in the units stated.

Do not write in this space

(20 marks)

21 List all the common factors of 14 and 35

Ans: _____

22 The figure below is drawn on a square grid.

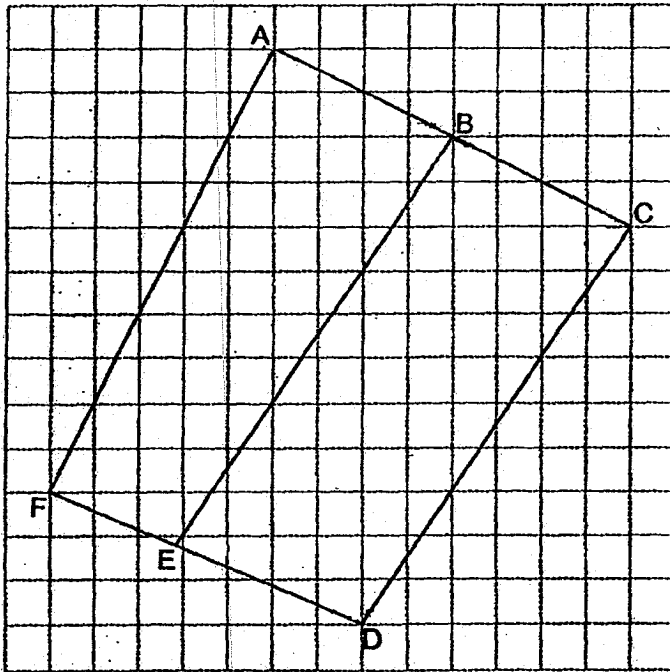

- (a) Name two lines that are parallel to each other.
- (b) Name two lines that are perpendicular to each other.

Ans: (a) _____ and _____

(b) _____ and _____

- 23 The opening hours of a gym are shown below.

Do not write
in this space

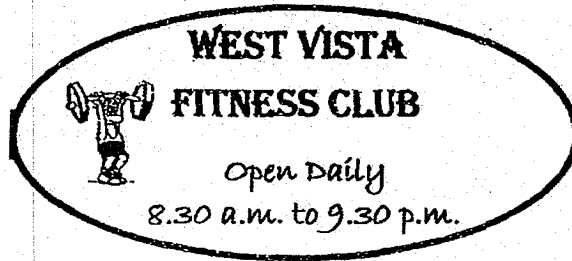

- (a) How long is the gym open each day?
- (b) Mrs Ling spent 1 h 45 min at the gym. Given that she finished her workout at 5.25 p.m., what time did she start her workout?

Ans: (a) _____ h

(b) _____ p.m.

- 24 In the figure, PQ and RS are straight lines. Find $\angle z$.

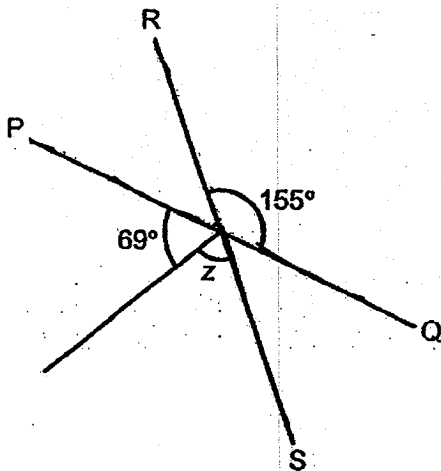

Ans: _____ $^\circ$

- 25 Find the area of the shaded part of the figure.

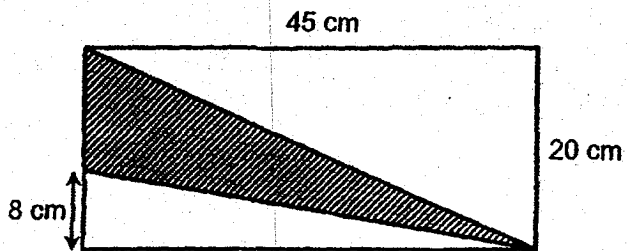

Ans: _____ cm²

Do not write
in this space

- 26 The bar graph shows the number of funfair tickets sold by a group of students. The bar showing the number of students who sold 3 tickets each is not shown. Given that $\frac{3}{8}$ of the students sold 3 tickets each, find the number of students who sold 3 tickets each.

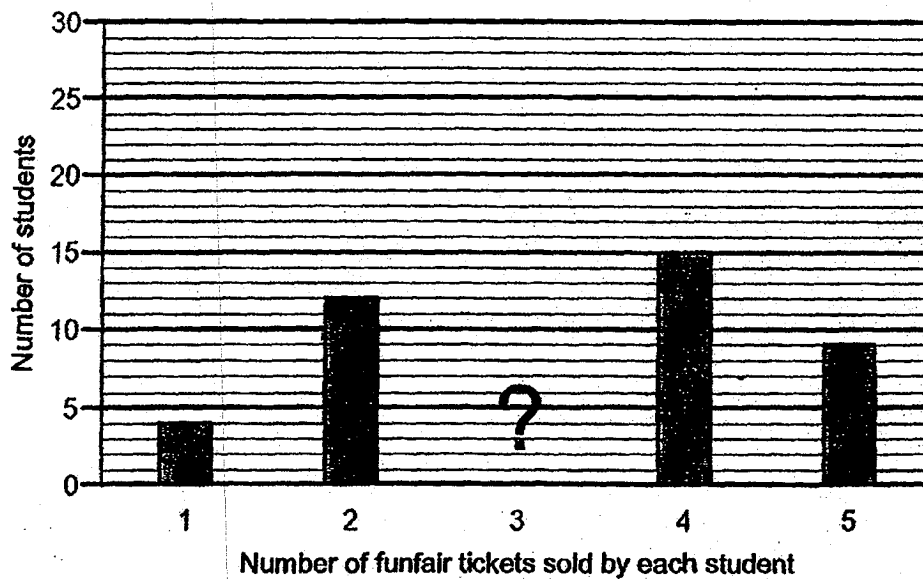

Ans: _____

27

The rectangular tank shown below is $\frac{2}{3}$ -filled with water. The base area of the tank is 120 cm^2 . Given that it contained 2.4 litres of water, what is the height of the container?

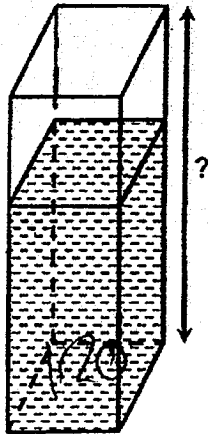

Ans: _____ cm

Do not write in this space

28

In the figure, ABCD and AEFG are identical rhombuses, $\angle BAG = 75^\circ$ and $\angle EFG = 65^\circ$. Find $\angle ABE$.

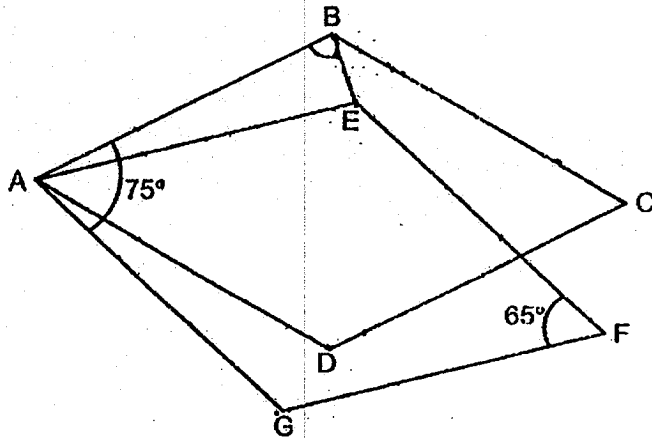

Ans: _____ °

29

The table below shows how much a shop charges a customer for renting an electric scooter.

Do not write
in this space

First 1 hour	\$12
Every additional $\frac{1}{2}$ hour	\$4

Ayomi paid \$36 for renting an electric scooter starting from 07 30
What would be the latest time that she must return the scooter to the shop?
Express your answer using the 24-hour clock.

Ans: _____

30

The figure shows two circles. The ratio of the diameter of the small circle to the diameter of the large circle is 1 : 2. The area of the small circle is 42 cm^2 .
What is the area of the shaded part of the figure?

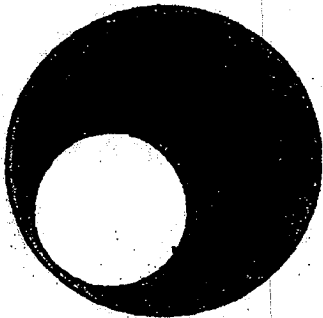

Ans: _____ cm^2



HENRY PARK PRIMARY SCHOOL
2019 PRELIMINARY EXAMINATION
MATHEMATICS
PRIMARY 6

PAPER 2

Parent's Signature

Name: _____ ()

Class: Primary 6 _____

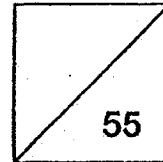

Time for Paper 2: 1 hour 30 minutes

Do not turn over this page until you are told to do so.

Follow all instructions carefully.

Answer all questions.

Show your working clearly as marks are awarded for correct working.

Write your answers in this booklet.

You are allowed to use a calculator.

Questions 1 to 5 carry 2 marks each. Show your working clearly and write your answers in the spaces provided. For questions which require units, give your answers in the units stated.

Do not write
in this space

(10 marks)

- 1 Joanne had a ribbon measuring 18 m in length. She cut the ribbon into shorter pieces, each measuring $\frac{4}{5}$ m.
- (a) What would be the most number of $\frac{4}{5}$ -m pieces that she could cut?
- (b) What would be the length of the ribbon left in the end?

Ans: (a) _____

(b) _____ m

- 2 The numbers on Card X and Card Y are 3-digit numbers. The first digit on Card Y is shown below.

Card X

3---

Card Y

Given that the average of the two numbers on Card X and Card Y is 300, find the smallest possible number on Card X.

Ans: _____

- 3 A piece of paper in the shape of a parallelogram is folded along the dotted line as shown below. Find $\angle y$

Do not write
in this space

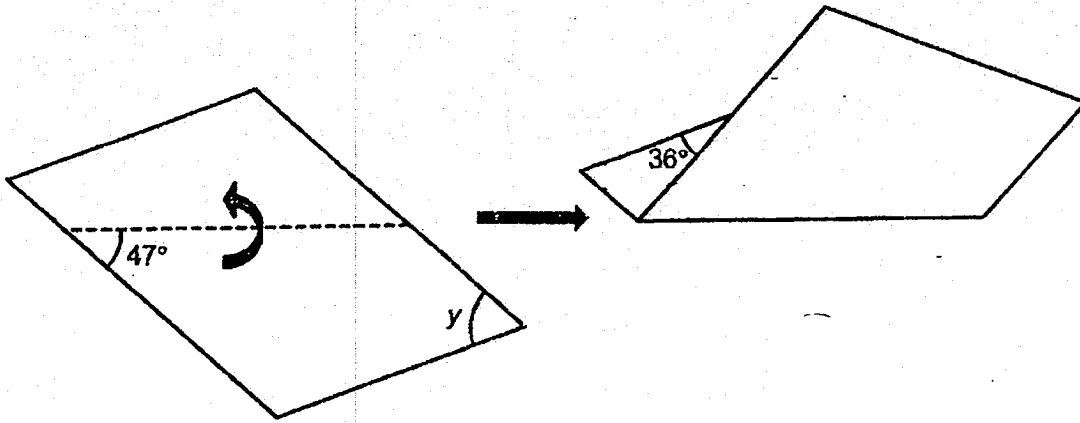

Ans: _____ °

- 4 In the figure below, JKLM is a square, $\angle MLO = 11^\circ$ and $KL = KO$. Find $\angle JOK$.

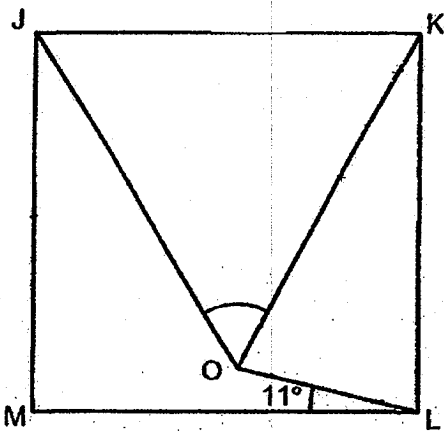

Ans: _____ °

- 5 Two lines, AB and AC, are drawn inside a box.

Do not write
in this space

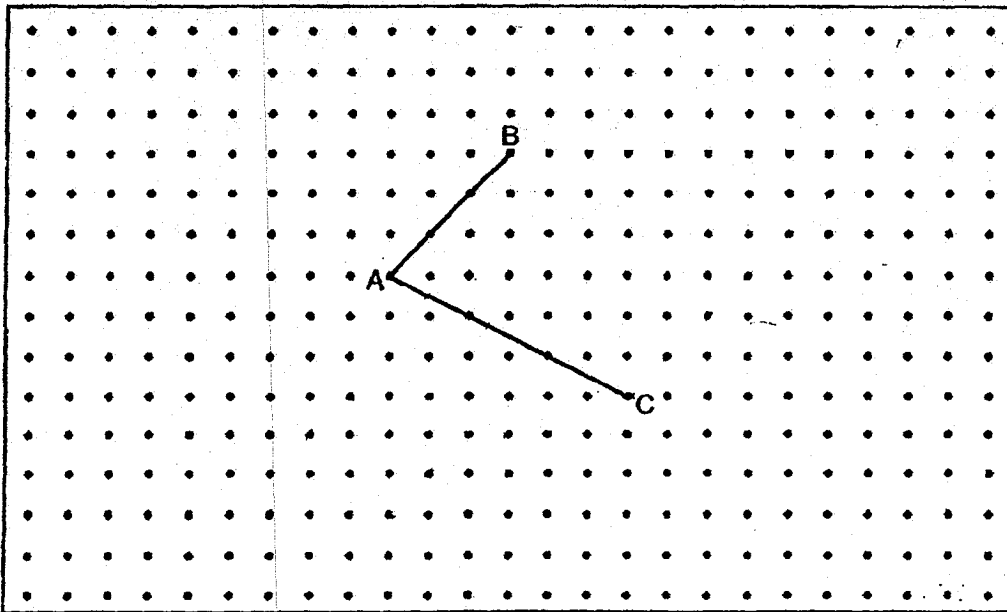

- (a) X is one of the dots inside the box. Draw two lines AX and CX to complete a right-angled triangle ACX with $AC = AX$.
- (b) Y ^{is} in one of the dots inside the box. Draw two lines BY and CY to complete a trapezium ABYC where AB is parallel to CY and the length of CY is twice the length of AB.



For questions 6 to 17, show your working clearly and write your answers in the spaces provided. The number of marks available is shown in the brackets [] at the end of each question or part-question.

Do not write in this space

(45 marks)

- 6 In a Sports Meet, the ratio of the number of runners in the Blue Team to the Red Team is 3 : 5. The ratio of the number of runners in the Yellow Team to the Blue Team is 3 : 4. There are 66 more runners in the Red Team than the Yellow Team. How many runners are there altogether?

Ans: _____ [3]

- 7 Isaac had 1.2 m of wire. He used all of it to form two equilateral triangles shown below.

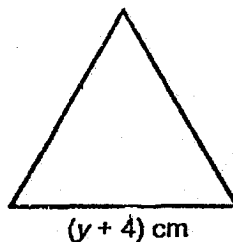
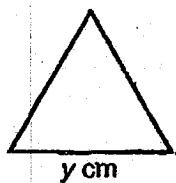

- (a) Find the total perimeter of both triangles in terms of y in the simplest form.
- (b) Find the value of y .

Ans: (a) _____ [1]

(b) _____ [2]

- 8 For every piano that Siti sells, she earns a sum of money as shown below.

Do not write
in this space

10% of the first \$500 of the selling price
and
8% of the remaining selling price

Siti sold a piano and earned \$650. What was the selling price of the piano?

Ans: _____ [3]

- 9 At first, Kendrick had a total of 117 pencils and erasers altogether. He gave away 25 pencils and bought more erasers to increase the number of his erasers by 60%. In the end, Kendrick had a total of 137 pencils and erasers altogether. How many pencils did Kendrick have at first?

Ans: _____ [3]

10

Joyce and Val ran in a race. Joyce ran at a speed of 200 m/min. When Val was at the halfway point of the race, Joyce was 2.5 km ahead of Val. Both of them did not change their speed throughout the race. Joyce completed the race at 11.50 a.m. What time did Val complete the race?

Do not write
in this space

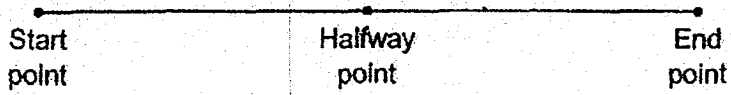

Ans: _____ [3]

11

The pie chart below represents the number of marbles of four different colours in a box. There were 135 more green marbles than red marbles.

Do not write
in this space

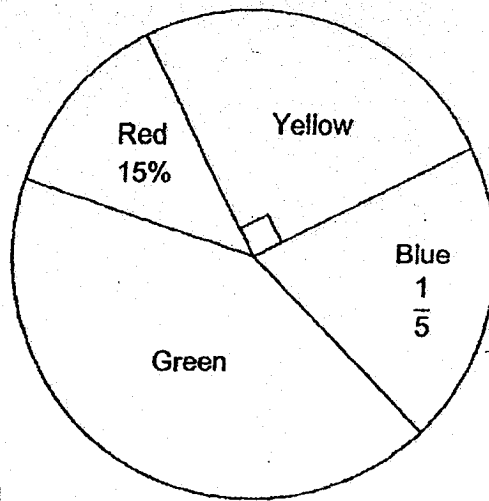

- (a) What percentage of the marbles in the box were green in colour?
- (b) All the marbles in the box were placed in 48 bags. Each bag contained either 8 or 14 marbles. How many of the bags contained 14 marbles?

Ans: (a) _____ [1]

(b) _____ [3]

12

In the figure, $ABCG$ is a trapezium and $BCEF$ is a rhombus. Lines BED and BFG are straight lines. Given that $AB \parallel GC$, $EC = ED$, $\angle BFE = 76^\circ$, $\angle GCE = 17^\circ$ and $\angle AGB = 55^\circ$,

Do not write in this space

(a) find $\angle p$.

(b) find $\angle q$.

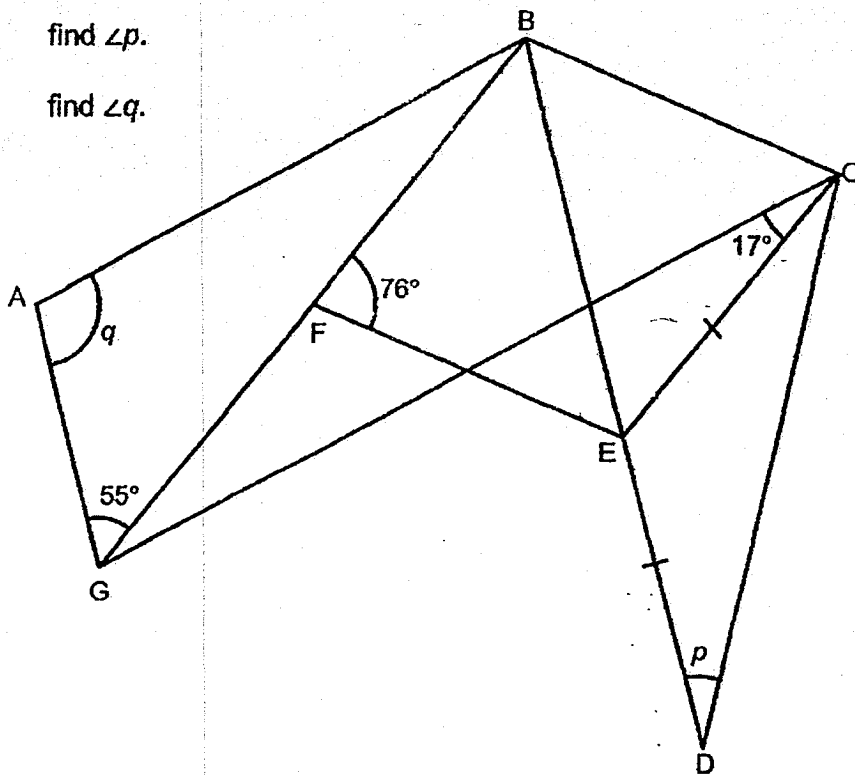

Ans: (a) _____ [2]

(b) _____ [1]

- 13 Tina had some 20¢, 50¢ and \$1 coins with a total value of \$300.60. 40% of the coins were 20¢ coins and $\frac{1}{8}$ of the remaining coins were \$1 coins.

Do not write
in this space

- (a) What is the ratio of the number of 20¢ coins to the number of 50¢ coins to the number of \$1 coins? Express your answer in the simplest form.
- (b) How many coins did Tina have altogether?

Ans: (a) _____ [2]

(b) _____ [3]

- 14 Dom had a square piece of paper with an area of 64 cm^2 . He cut out one quarter circle and three identical semicircles from it as shown below. The quarter circle had the same radius as each semicircle.

Do not write
in this space

- (a) What is the radius of the quarter circle?
(b) What is the perimeter of the remaining piece of paper?

(Take $\pi = 3.14$)

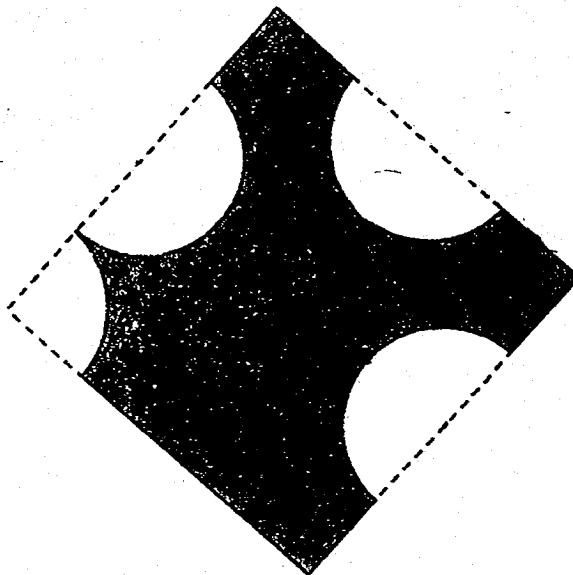

Ans: (a) _____ [2]

(b) _____ [3]

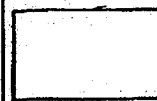

15

John uses triangles and circles to form figures that follow a pattern as shown below.

Do not write in this space

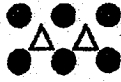

Figure 1

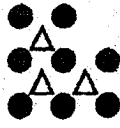

Figure 2

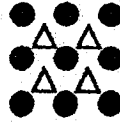

Figure 3

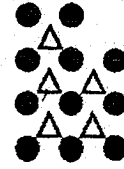

Figure 4

- (a) The table shows the number of triangles and circles for the first four figures. Complete the table for Figure 5.

Figure Number	1	2	3	4	5
Number of triangles	2	3	4	5	
Number of circles	6	8	9	11	
Total number of triangles and circles	8	11	13	16	

[1]

- (b) A figure in the pattern has a total of 51 triangles and circles. What is the Figure Number?
- (c) How many circles did John use for Figure 115?

Ans: (b) Figure _____ [2]

(c) _____ [2]



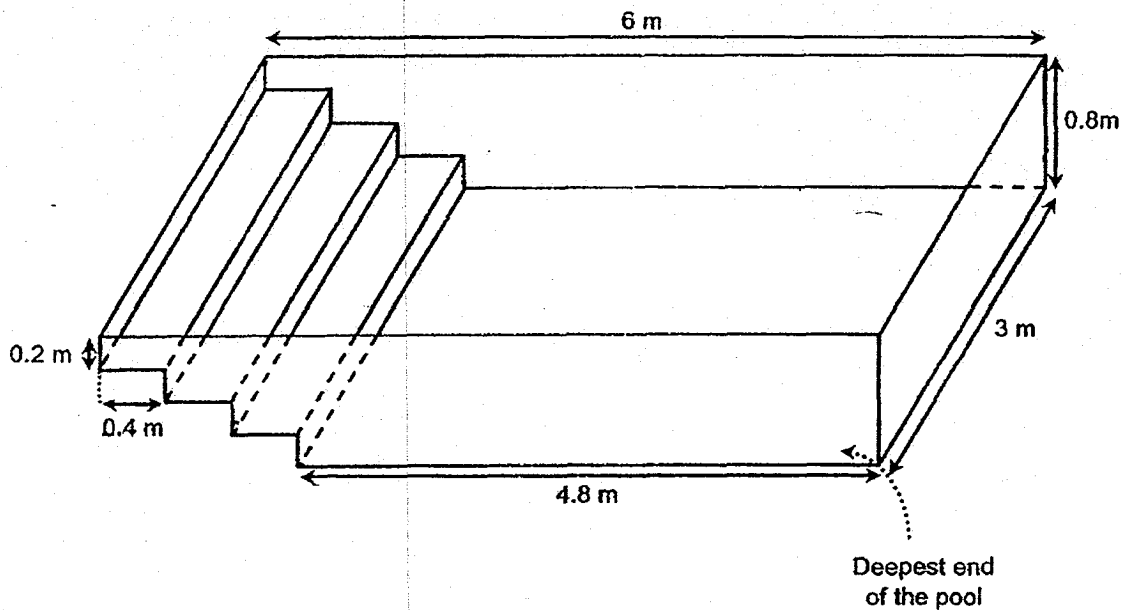

- 16 The figure below shows an empty wading pool with some steps at one side of the pool. Each step measures 0.2 m in height and 0.4 m in length. Mr Hank wants to fill the pool with water using a hose that allows water to flow at a rate of 1.395 m^3 per hour. How long will it take Mr Hank to fill the pool with water to a depth of 0.7 m measured from the deepest end of the pool?

Do not write in this space

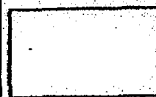

Ans: _____ [4]



- 17 Two square tiles of equal sides are shown below. Some parts of the tiles are painted in the shape of identical quarter circles ().

Do not write in this space



A floor is laid with the tiles that follow a pattern as shown below. The floor measures 5.2 m in length and 3.6 m in breadth and is completely covered with the tiles.

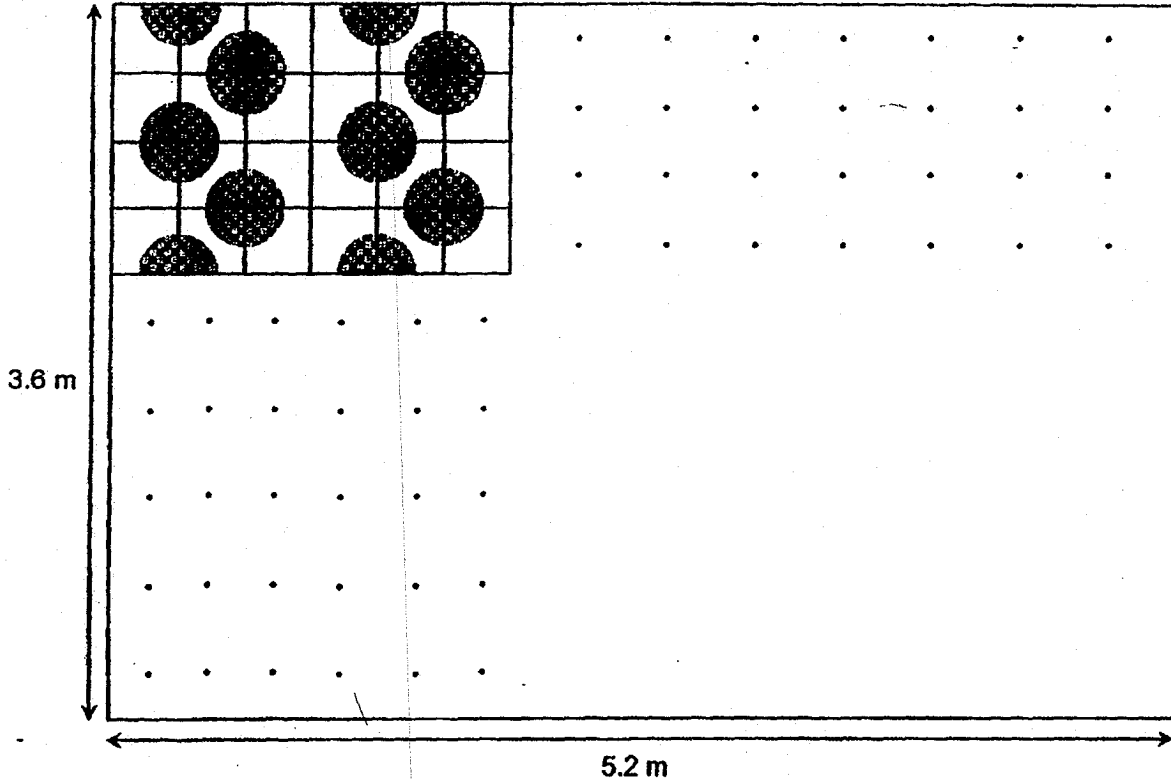

Find the area of the floor that is covered by the painted parts of the tiles.

(Take $\pi = \frac{22}{7}$)

(You may use the additional working space on the next page if necessary)

Ans: _____ [4]



(Additional working space for Question 17)

Do not write
in this space

Setters:

Mrs Elaine Chua, Mrs Irene Tan, Mr Jenfry Tseng, Mrs Ling Lee Ching and Mr Yip Yew Fei

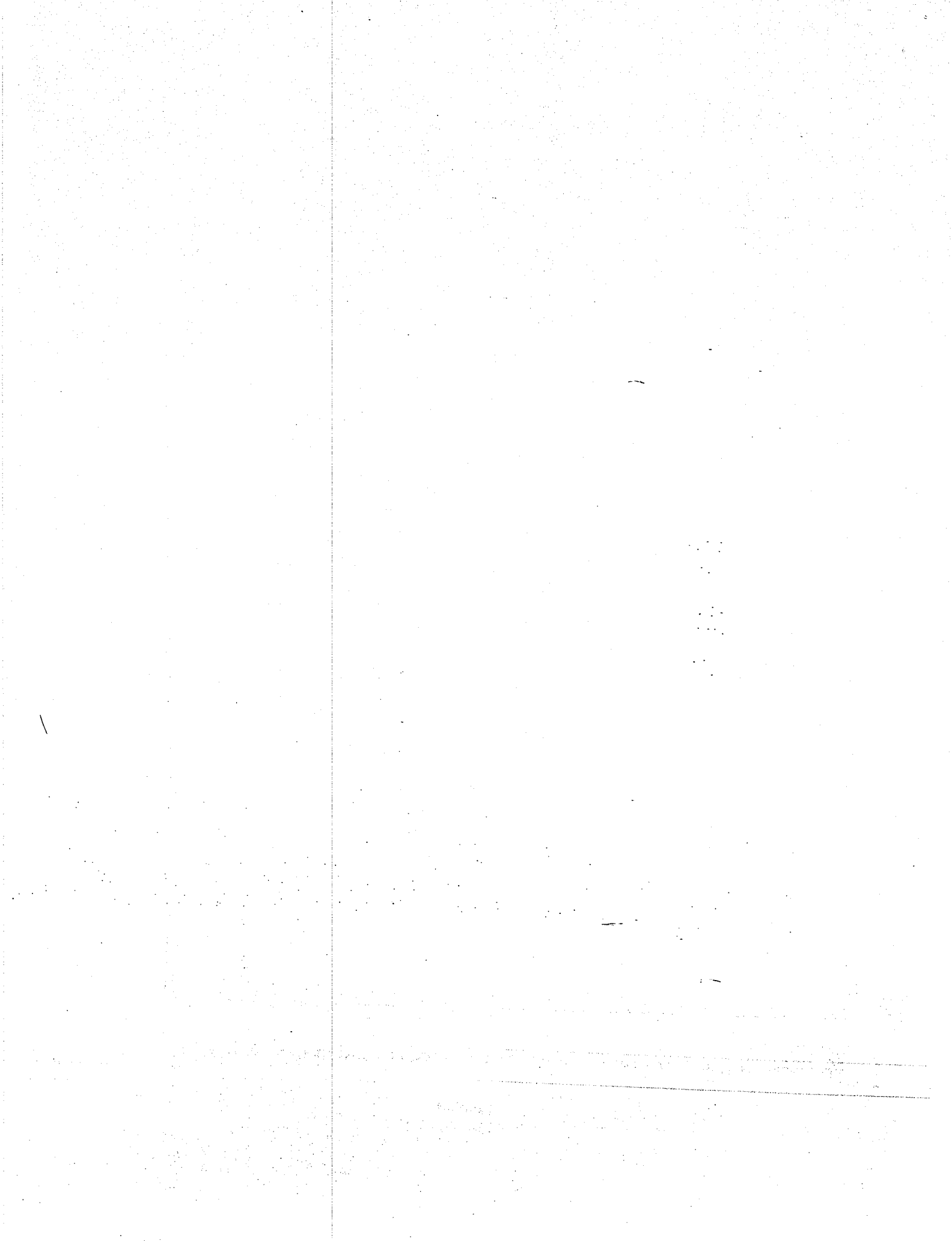

SCHOOL : HENRY PARK PRIMARY SCHOOL
LEVEL : PRIMARY 6
SUBJECT : MATH
TERM : 2019 PRELIM

PAPER 1 BOOKLET A

Q 1	Q2	Q3	Q4	Q5	Q6	Q7	Q8	Q9	Q10
1	2	4	3	4	1	1	4	3	1

Q 11	Q12	Q13	Q14	Q15
3	2	4	3	3

PAPER 1 BOOKLET B

Q16)	110.49
Q17)	5.08
Q18)	65
Q19)	37.49
Q20)	14
Q21)	1 and 7
Q22)	a)EB and DC b)FA and AB
Q23)	a)13h b)3.40 p.m.
Q24)	86°
Q25)	270 cm ²
Q26)	24 tickets
Q27)	30cm
Q28)	85°
Q29)	1130
Q30)	126cm ²

PAPER 2

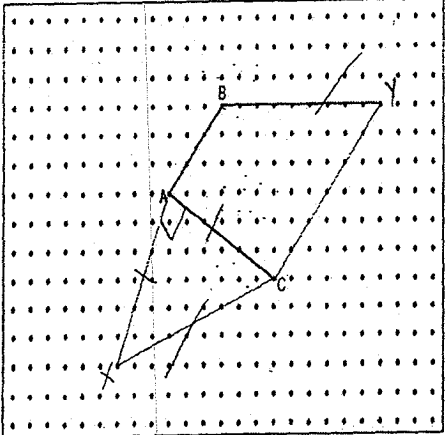
Q1)	a)22 b)0.4m
Q2)	$300 \times 2 = 600$ $600 - 399 = 201$
Q3)	$180^\circ - 47^\circ = 133^\circ$ $180^\circ - 47^\circ - 47^\circ = 86^\circ$ $180^\circ - 86^\circ - 36^\circ = 58^\circ$
Q4)	$90 - 22 = 68$ $\frac{180-68}{2} = 56$
Q5)	
Q6)	$20u - 9u = 11u$ $11u = 66$ $1u = 66 \div 11 = 6$ $9u + 12u + 20u = 41u$ $41u = 6 \times 41 = 246$
Q7)	a) $(3y + 3y + 12)\text{cm}$ $= (6y + 12)\text{cm}$ b) $(6y + 12)\text{cm} = 120\text{cm}$ $6y \text{ cm} + 12\text{cm} = 120\text{cm}$ $(6y)\text{cm} = 120\text{cm} - 12\text{cm} = 108\text{cm}$ $1y = 108\text{cm} \div 6 = 18\text{cm}$
Q8)	$650 - 50 = 600$ $600 \div 8\% = 7500$ $7500 + 500 = 8000$

Q9)	42 pencils
Q10)	$2500 \times 2 = 5000$ $5000 \div 200 = 25\text{min}$ 25min after 11.50 a.m. is 12.15 p.m.
Q11)	a) $100\% - 25\% - 15\% - 20\% = 40\%$ b) $15\% + 135 \rightarrow 40\%$ $25\% \rightarrow 135$ $1\% \rightarrow 135 \div 25 = 5.4$ $81 + 216 + 135 + 108 = 540$ <u>Assume all as 8 marbles</u> $8 \times 48 = 384$ $540 - 384 = 156$ $156 \div 6 = 26$ bags
Q12)	a) $(180^\circ - 76^\circ) \div 2 = 52^\circ$ $180^\circ - 52^\circ = 128^\circ$ $(180^\circ - 128^\circ) \div 2 = 26^\circ$ b) $180^\circ - 59^\circ = 121^\circ$ $121^\circ - 52^\circ - 52^\circ = 17^\circ$ $180^\circ - 17^\circ - 55^\circ = 108^\circ$
Q13)	a) $16 : 21 : 3$ b) $3.2u + 10.5u + 3u = 16.7u$ $16.7u = \$300.60$ $1u = \$300.60 \div \$16.7u = 18$ $16u + 21u + 3u = 40u$ $40u = 40 \times 18 = 720$ coins
Q14)	a) $\sqrt{64\text{cm}^2} = 8\text{cm}$ $8\text{cm} \div 4 = 2\text{cm}$ b) $2\text{cm} + 2\text{cm} + 2\text{cm} + 2\text{cm} + 2\text{cm} + 2\text{cm} + 4\text{cm} = 16\text{cm}$ Arc of 1 quarter circle = $\frac{1}{4} \times \pi \times d = \frac{1}{4} \times 3.14 \times 4\text{cm} = 3.14\text{cm}$ $3.14\text{cm} \times 7 = 21.98\text{cm}$ $21.98\text{cm} + 16\text{cm} = 37.98\text{cm}$
Q15)	a) 6, 12, 8 b) 18 c) $3 \times 58 + 13 = 177$
Q16)	8 hours
Q17)	97020 cm ²

