



**RAFFLES GIRLS' PRIMARY SCHOOL**  
**SEMESTRAL ASSESSMENT (1)**  
**2019**

Section A	56
Section B	44
Total score %	
Parent's signature	

Name : \_\_\_\_\_ Index No.: \_\_\_\_\_ Class: P6 \_\_\_\_\_ Date: \_\_\_\_\_

**15 May 2019**

**SCIENCE**

**ATT: 1 h 45 min**

**SECTION A (28 x 2 marks)**

For each question from 1 to 28, four options are given. One of them is the correct answer. Make your choice (1, 2, 3 or 4). Shade the correct oval (1, 2, 3 or 4) on the Optical Answer Sheet (OAS) provided.

1. Susan carried out an experiment on the germination of seeds using two containers, P and Q, in her room as shown below. She observed the seeds in the containers over one week.

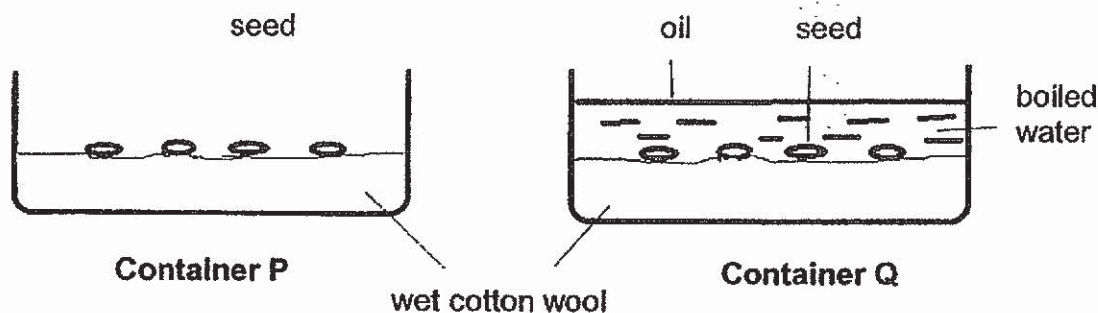

Based on this experiment, what could Susan most likely observe and conclude?

- (1) Seeds in both containers did not germinate, as sunlight was absent.
- (2) Seeds in container Q did not germinate as the layer of oil blocked out sunlight.
- (3) Seeds in container P germinated but not those in container Q as there was no air in container Q.
- (4) Seeds in container Q germinated but not the seeds in container P as water was absent in container P.

2. James wanted to find out the conditions needed to slow down the rate of decomposition. He carried out the following experiment using three fresh mushrooms in each of the flasks, A, B, C, D and E. He kept the mushrooms in different conditions.

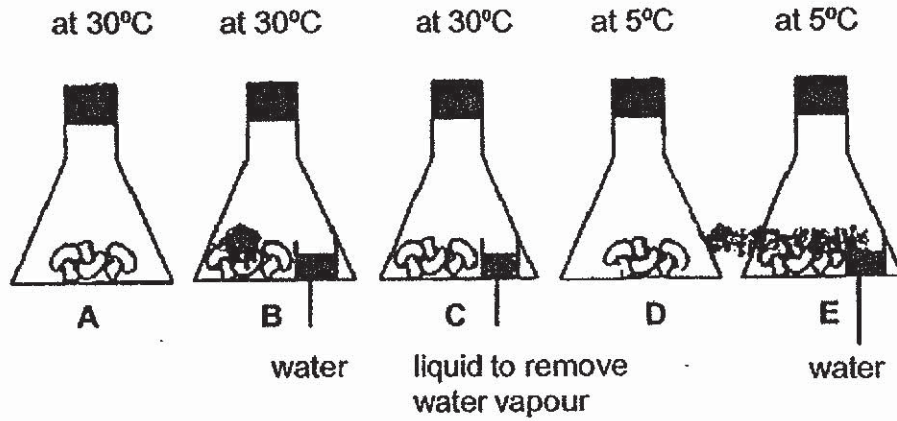

After one week, he recorded his observations in the table as shown below.

Flasks	A	B	C	D	E
Shows signs of decomposition	Yes	Yes	No	No	Yes

Based on his findings above, which one of the following conditions would slow down the rate of decomposition?

- (1) moist
- (2) at 30°C
- (3) dry and at 5°C
- (4) moist and at 5°C

3. The diagram below shows the life cycle of a flowering plant.

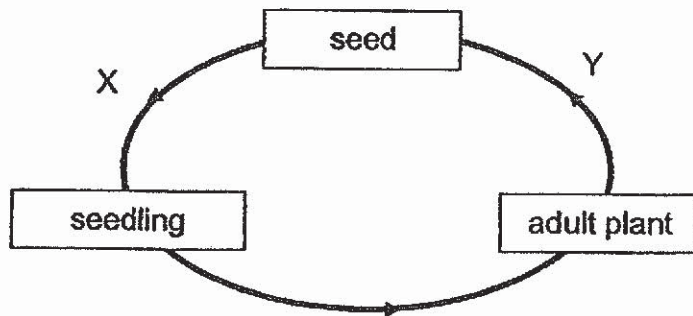

Which of the following processes take place at X and Y respectively?

- A Fruit formation
- B Dispersal of seed
- C Pollination of flower
- D Germination of seed

	Process(es) at X	Process(es) at Y
(1)	D only	A, B and C only
(2)	A, B and D only	C only
(3)	B and C only	A and D only
(4)	A and D only	B and C only

4. The table below shows the characteristics of Mr and Mrs Lim.

	<b>Mr Lim</b>	<b>Mrs Lim</b>
<b>Natural hair colour</b>	brown	black
<b>Hair length</b>	short	short
<b>Types of eyelids</b>	single	double
<b>Ears</b>	attached earlobes	detached earlobes

Which of the following states correctly the inherited characteristics of each of their four children?

<b>Child</b>	<b>Inherited traits</b>
A	long and brown hair, attached earlobes
B	short hair, detached earlobes, single eyelids
C	black hair, double eyelids, detached earlobes
D	brown hair, double eyelids, attached earlobes

- (1) A only
- (2) B and C only
- (3) C and D only
- (4) A, B and D only



5. Study the diagram below.

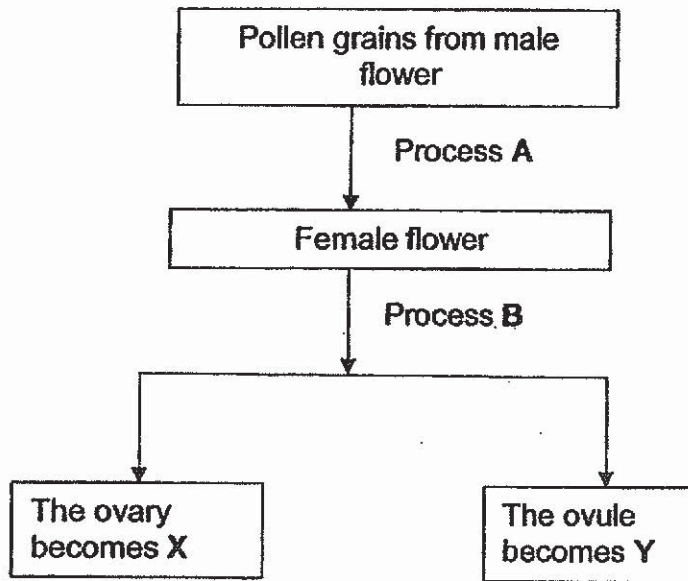

Which one of the following correctly identifies A, B, X and Y?

	Process		Parts of the plant	
	A	B	X	Y
(1)	pollination	fertilisation	seed	fruit
(2)	fertilisation	pollination	fruit	seed
(3)	pollination	fertilisation	fruit	seed
(4)	fertilization	pollination	seed	fruit

6. Sheila counted the number of wild plants X and Y on a piece of land over several months. Her observations are shown below.

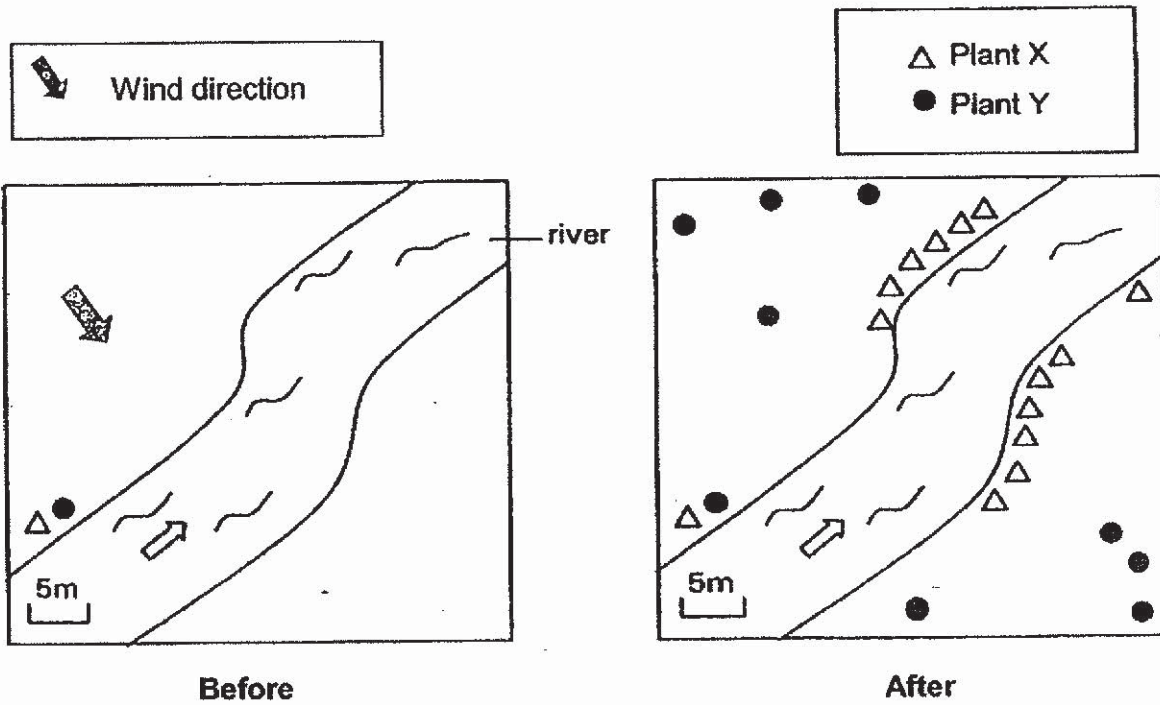

Which one of the following correctly identifies the characteristics of the fruit and seeds of plants X and Y?

Physical characteristics the fruit most likely has	
Plant X	Plant Y
(1) waterproof covering	edible and fleshy
(2) hooks	pod-like structure
(3) fibrous husks	waterproof covering
(4) edible and fleshy	hooks

7. Four different types of food, P, Q, R and S, were mixed with digestive juices when passed through the digestive system.

The graphs below show the amount of undigested food left at the start and at the end of ten hours.

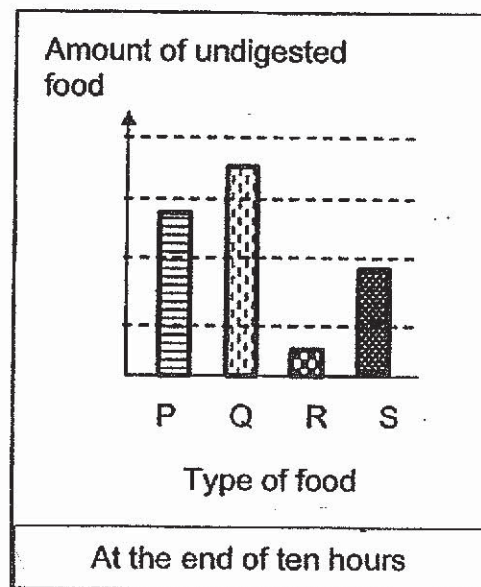
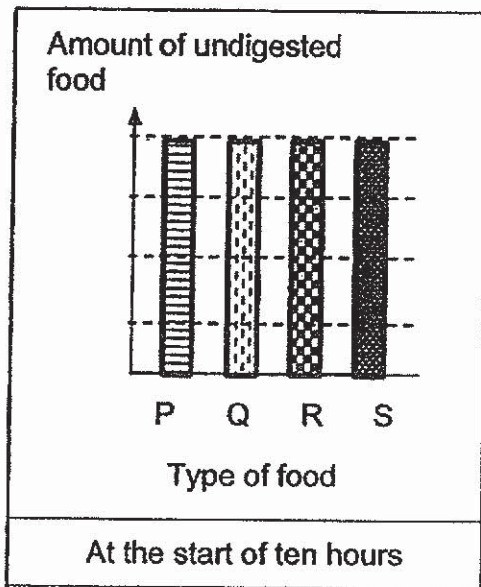

Based on the above graphs, which type of food would be mostly absorbed into the bloodstream in the small intestine of the digestive system?

- (1) P
- (2) Q
- (3) R
- (4) S

8. The diagram below shows the different stages of development, A, B, and C, of a plant.

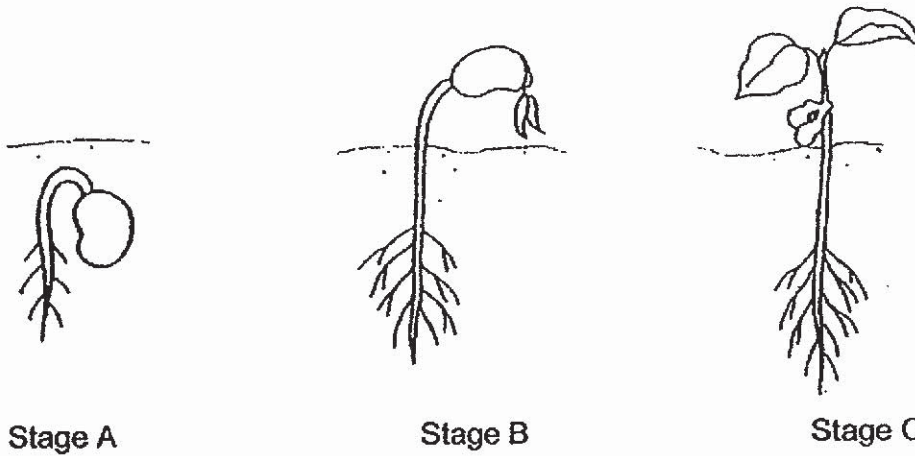

At which stage(s) shown above does/do the seed leaves provide food for the plant to grow?

- (1) A only
- (2) B only
- (3) A and B only
- (4) A, B and C

9. The diagrams below show three cells P, Q and R.

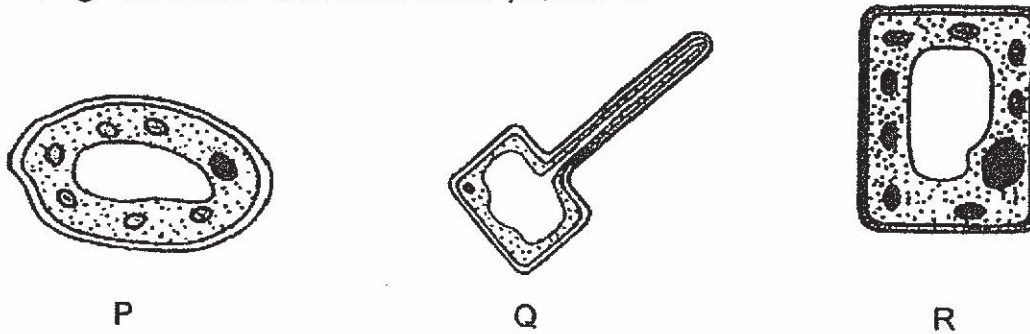

Which one of the following statements is correct?

- (1) Only P and R have cell wall and chloroplasts.
  - (2) Q is an animal cell as it does not have chloroplasts.
  - (3) Q is a plant cell found in the leaves and roots of plants.
  - (4) All three cells are plant cells as they have nucleus, cell wall, chloroplast and cytoplasm.
10. Betty drew the diagram below to show the direction of blood flow in the human body represented by the arrows.

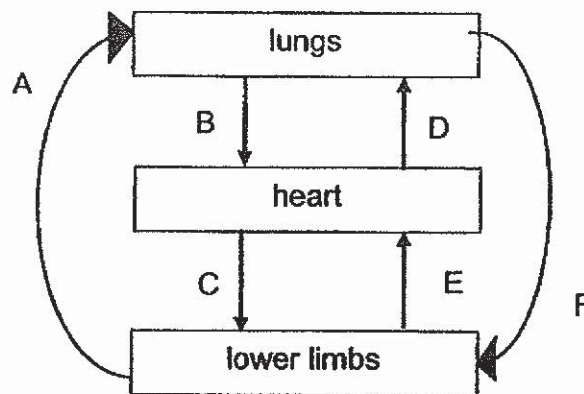

Which arrow(s) represent(s) the direction of blood flow incorrectly?

- (1) F only
- (2) B and D only
- (3) C and E only
- (4) A and F only



11. The set-up in diagram 1 was used to measure the distance moved by an air bubble in the glass tube when the plant took in water.

Lily added a fan beside the set-up (diagram 2) to study how the speed of the fan affects the distance moved by the air bubble in the glass tube.

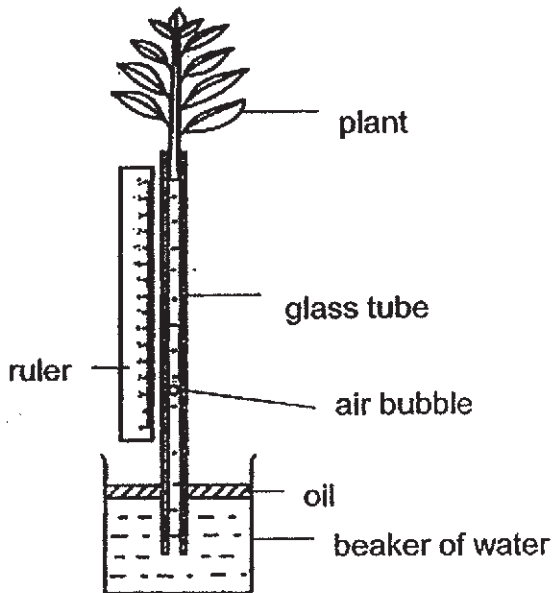

Diagram 1

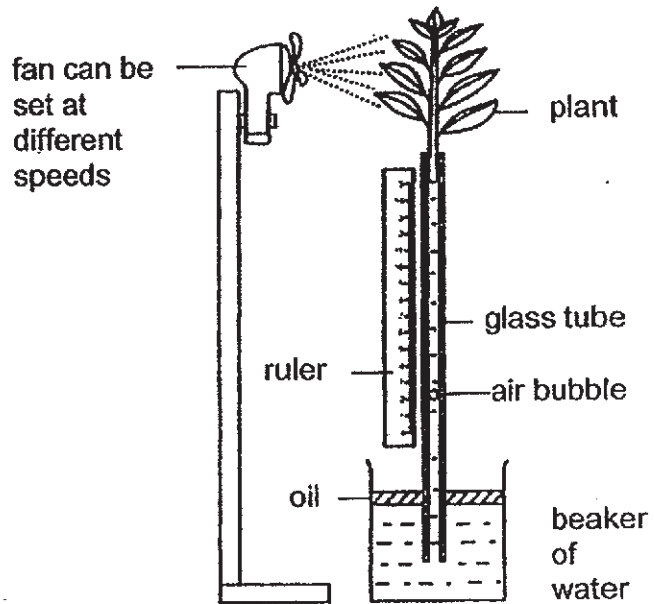
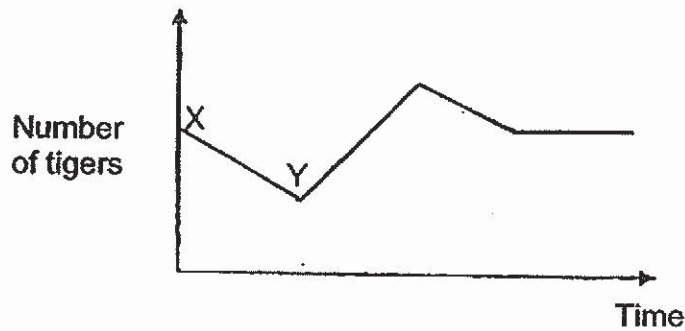

Diagram 2

Which one of the following correctly explains why the air bubble moved a greater distance up the glass tube when the fan speed increased?

- (1) More water was evaporated from the beaker of water.
- (2) The wind from the fan increased the rate of condensation.
- (3) The rate of photosynthesis increased as the fan speed increased.
- (4) More water was lost in the form of water vapour through the stomata.

12. The graph below shows the change in the population of tigers in a jungle. Tigers feed on other animals such as deer and wild boars.



Which of the following event(s) could most likely to have caused a change in the tiger population from Point X to Point Y on the graph?

- A An increase in the food source for deer.
- B An increase in the reproduction rate of wild boars.
- C An increase in the population of other animals feeding on deer.

- (1) C only
- (2) A only
- (3) A and B only
- (4) B and C only

13. The table below shows the characteristics of the environment found in four different habitats during the day.

Habitats	Average temperature (°C)	Amount of water	Amount of light
A	30	Plenty	Little
B	5	Little	Little
C	42	Little	Plenty
D	25	Plenty	Plenty

Organism X has the following characteristics:

- Sensitive to light
- Breathes through moist skin
- Able to live in areas with temperature range from 20°C to 32°C

Which one of the following habitats, A, B, C or D, would be best suited for Organism X?

- (1) A
- (2) B
- (3) C
- (4) D

14. The number of organisms in a pond is shown in the table below.

<b>Organisms</b>	<b>Number of organisms</b>
ducks	4
frogs	6
tadpoles	7
water lily	3
male goldfish	4
goldfish eggs	20
female goldfish	6
water hyacinth	5

Based on the information above, which of the following statements is correct?

- (1) There is 1 habitat and 5 populations.
- (2) There is 8 communities and 1 habitat.
- (3) There is 1 community and 8 populations.
- (4) There are 55 populations and 5 communities.

15. Study the food web below.

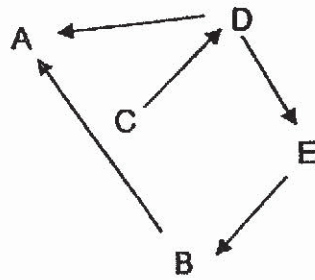

Which of the following statements best describes what will happen to the other populations if the population of D is wiped out by a disease?

- (1) Population A will increase.
  - (2) Population E will decrease.
  - (3) Population C will decrease.
  - (4) Population B will remain unchanged.
16. Peter wanted to find out if carbon dioxide is needed for photosynthesis. He used a plant which had green areas in the middle and white areas around the edges as shown below.

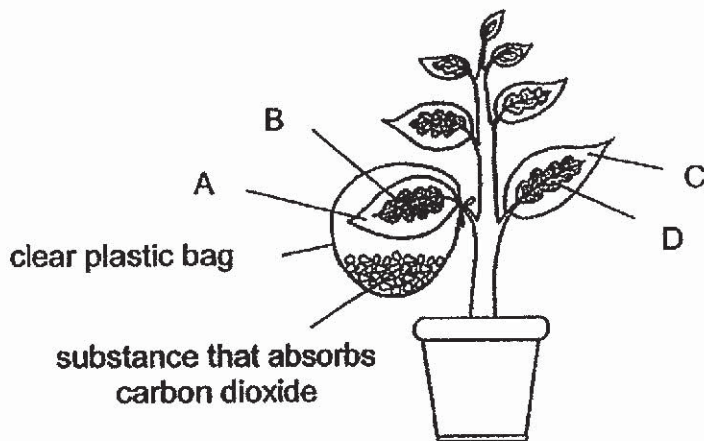

Which of the following two areas should Peter compare to show that carbon dioxide is needed for photosynthesis?

- (1) A and B only
- (2) A and C only
- (3) B and D only
- (4) C and D only



17. The diagram below shows a tent.

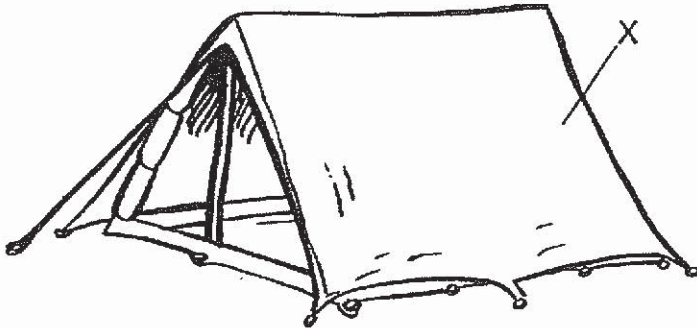

Study the properties of the four materials shown below.

Material	Property of material		
	Waterproof	Flexible	Strong
A	√		√
B	√	√	√
C	√	√	
D		√	√

Which material is most suitable for making part X of the tent?

- (1) A
- (2) B
- (3) C
- (4) D

18. The diagram below shows a container containing an ice block left in an air-conditioned room with a constant temperature of  $18^{\circ}\text{C}$  and the change observed after five minutes.

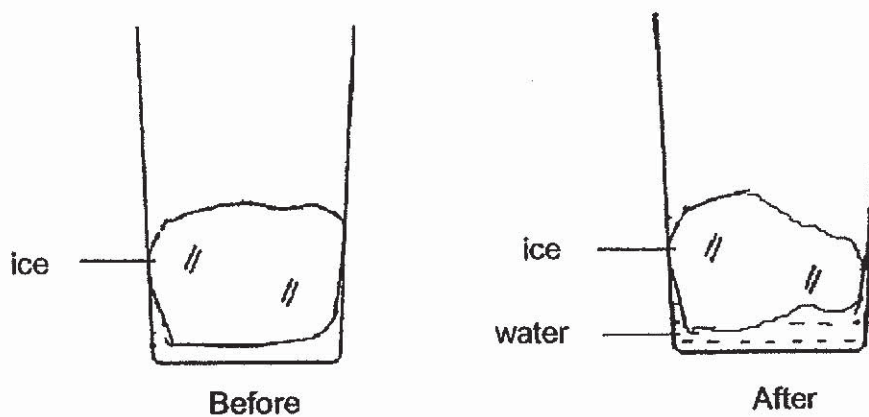

Which of the following statement(s) is / are correct?

- A The temperature of ice remained at  $0^{\circ}\text{C}$ .
  - B The temperature of ice and water rose to  $18^{\circ}\text{C}$ .
  - C The ice melted as it gained heat from the water only.
  - D The temperature of water remained at  $0^{\circ}\text{C}$  when the ice is melting.
- 
- (1) B only
  - (2) C only
  - (3) A and D only
  - (4) B and C only

19. The graph below shows the temperature of solid substance X when heated.

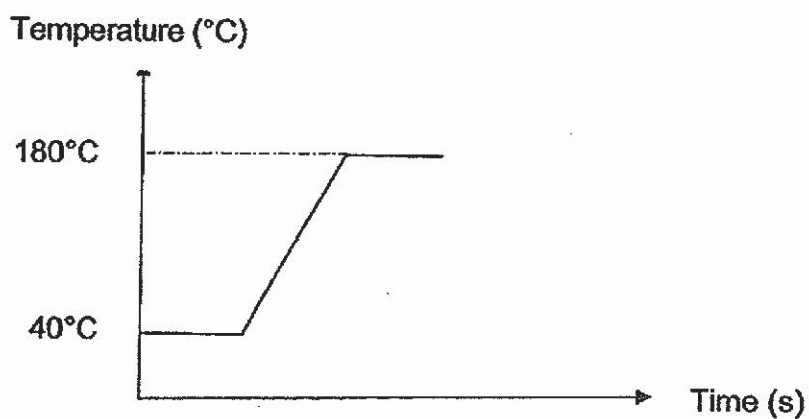

Which one of the following shows correctly the state(s) of substance X at 20°C and at 210°C?

State of substance X at	
20°C	210°C
(1) solid	liquid
(2) solid	gas
(3) liquid	gas
(4) liquid	liquid

20. Sami used the set-up below to attract iron pins.

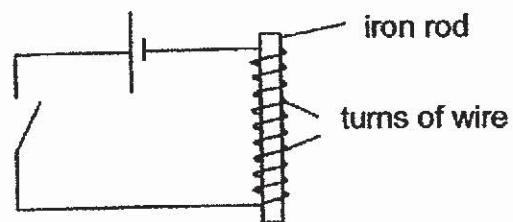

He added more batteries in the set-up and recorded the number of pins attracted.

Number of pins attracted

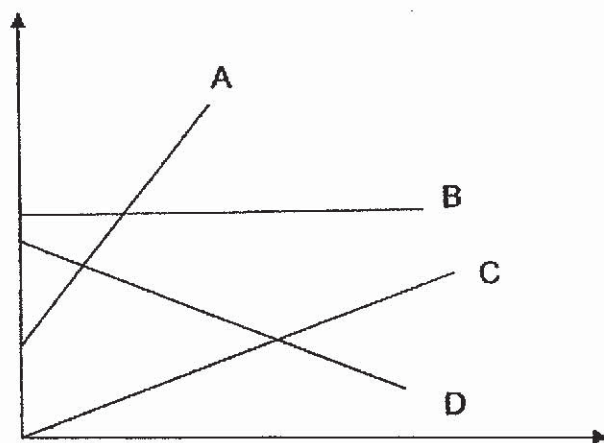

Number of batteries

Which one of the lines, A, B, C or D, in the graph shows the result of his experiment correctly?

- (1) A
- (2) B
- (3) C
- (4) D

21. William set up a circuit as shown below. He wanted the bulb in the circuit to switch on and off on its own after he had turned on the switch.

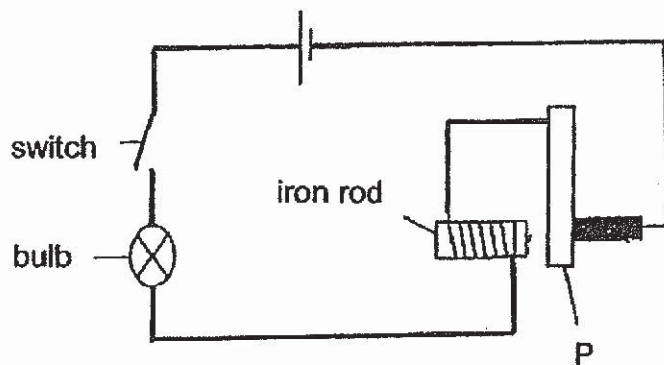

However, when William turned on the switch, he observed the bulb lit up. The bulb only went off when he turned off the switch.

Which of the following could have caused this to happen?

P is made of \_\_\_\_\_.

- A steel
- B wood
- C copper

- (1) A only
- (2) B only
- (3) C only
- (4) A and B only



22. Similar rods of different materials were placed near a bar magnet as shown below.

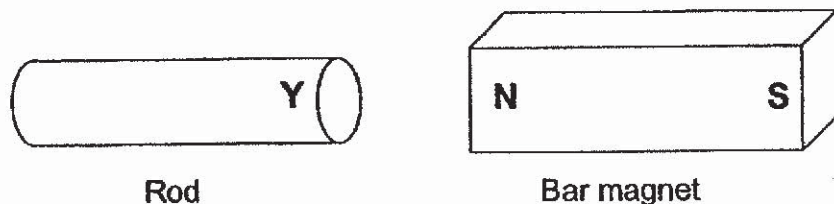

Part Y of each rod was brought near to the North-seeking pole and South-seeking pole of the bar magnet. The results are shown in the table below.

Material of Rod	North-seeking pole	South-seeking pole
A	Attracts	Repels
B	Attracts	Attracts
C	Repels	Attracts
D	Remains in its original position	Remains in its original position

Which one of the following statements is correct?

- (1) C can attract D.
- (2) A, B and C are magnetic materials.
- (3) B and D can be made into magnets.
- (4) A and C are poor conductors of heat.

23. Ah Seng kicked a soccer ball with his foot. The diagram below shows the path of the ball after he had kicked it.

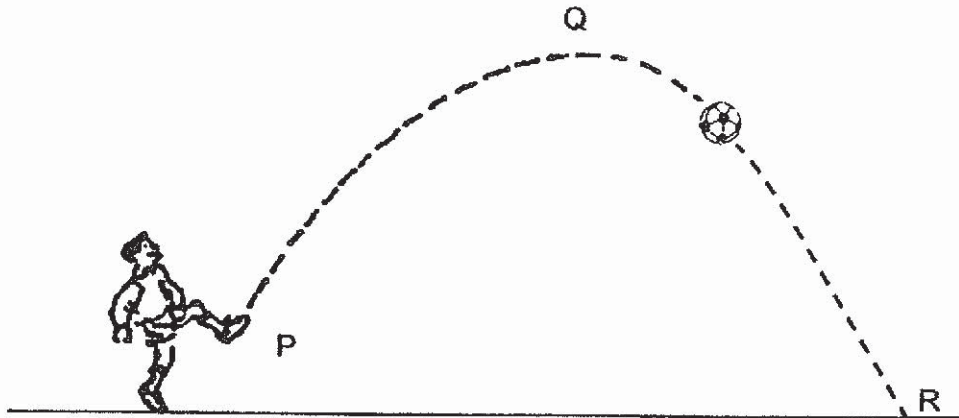

Which of the following statements about the soccer ball is/are true?

- A When it reached the ground at R, no force acted on it.
  - B Its kinetic energy increased as it moved from P to Q but decreased as it moved to R.
  - C When it reached Q, there was greatest amount of gravitational force acting on it.
  - D The amount of gravitational force acting on it is the same throughout its journey from P to R.
- (1) A only  
(2) D only  
(3) B and C only  
(4) A, B and C only

24. Two identical blocks are placed on two ramps of the same size. The blocks were released from the same height. The block in set-up A did not move but the block in set-up B slid down the ramp.

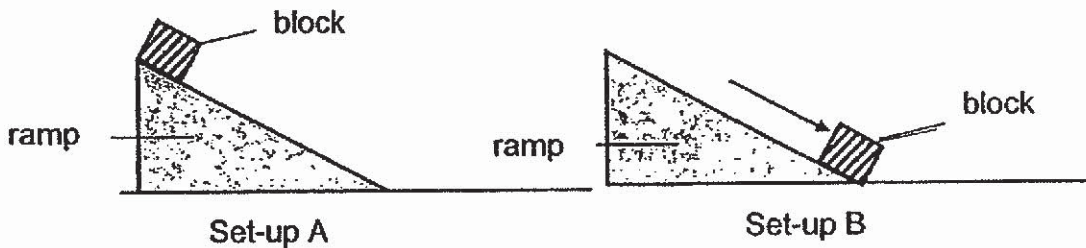

Which of the following statements is/are likely explanation(s) for the observation?

- A The block in Set-up B has greater gravitational force acting on it than that in Set-up A.
- B There is greater frictional force between the block and the ramp in Set-up A than in Set-up B.
- C In Set-up A, the frictional force between the block and the ramp is greater than the gravitational force acting on the block.

- (1) A only
- (2) B only
- (3) A and B only
- (4) B and C only

25. Mary set up an experiment in a dark room. She shone a torch on a ball as shown in the diagram below. A shadow of the ball was cast on the screen.

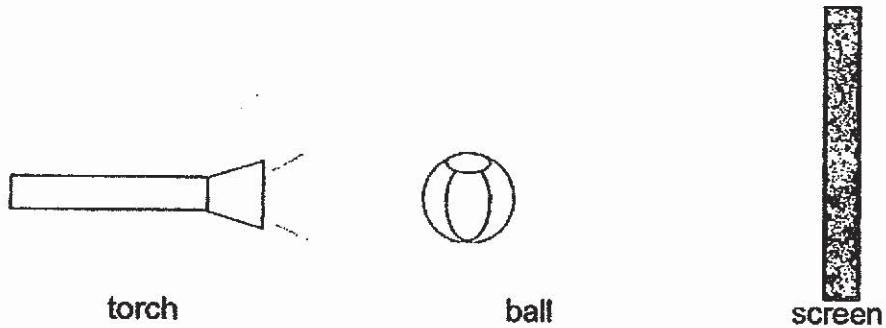

What could Mary do to cast a smaller shadow on the screen?

- A Move the torch towards the ball.
  - B Move the screen towards the ball.
  - C Move the torch further away from the ball.
  - D Move the ball further away from the torch.
- 
- (1) A and B only
  - (2) B and C only
  - (3) C and D only
  - (4) B, C and D only

26. John was instructed by his uncle to fit a metal rim tightly round the wooden cartwheel, as shown in the diagrams below.

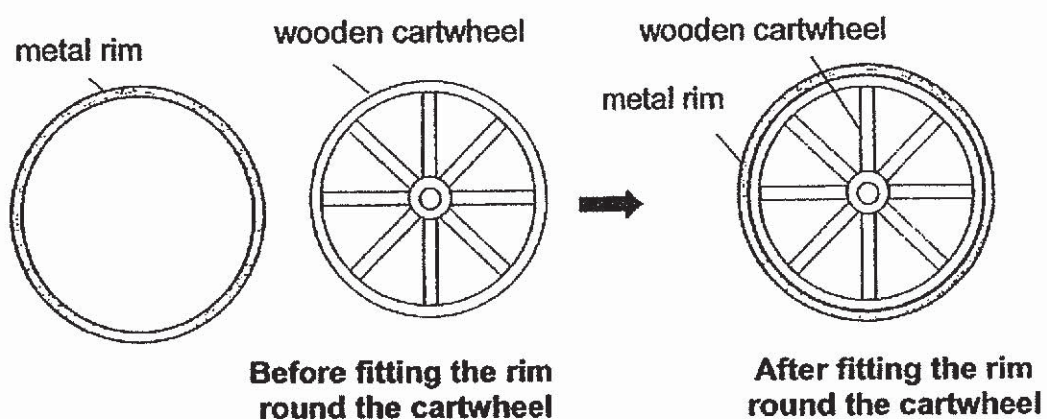

However, the metal rim that John had was too small to fit round the wooden cartwheel. His uncle suggested two steps to complete the task.

Which of the following steps would allow John to fit the metal rim tightly round the wooden cartwheel in the shortest time?

- A Immerse the metal rim and wooden cartwheel in cold water before fitting the metal rim round the cartwheel.
  - B Heat the metal rim and immerse the wooden cartwheel in cold water before fitting the metal rim around the cartwheel.
  - C Immerse the metal rim and cartwheel in hot water after fitting the rim round the cartwheel.
  - D Immerse the metal rim and cartwheel in cold water after fitting the rim around the cartwheel.
- (1) A and C only  
(2) A and D only  
(3) B and C only  
(4) B and D only



27. Ahmad conducted an experiment using set-ups X and Y as shown below. In set-up X, he wrapped a glass beaker with material A. In set-up Y, an identical glass beaker was wrapped with material B. He filled both beakers with the same volume of hot water at 85 °C.

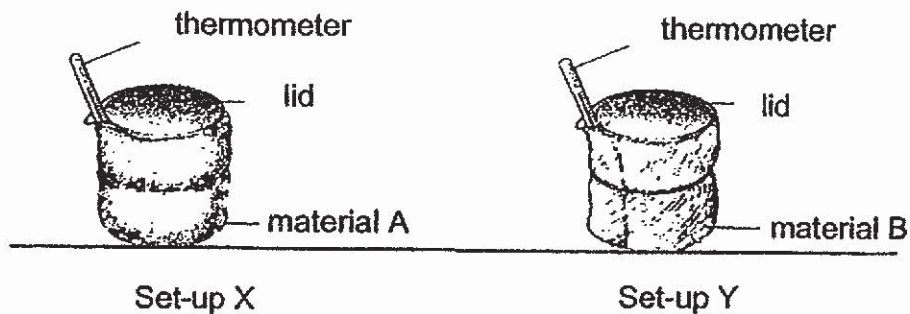

The graph shows the temperature in both set-ups over 10 minutes.

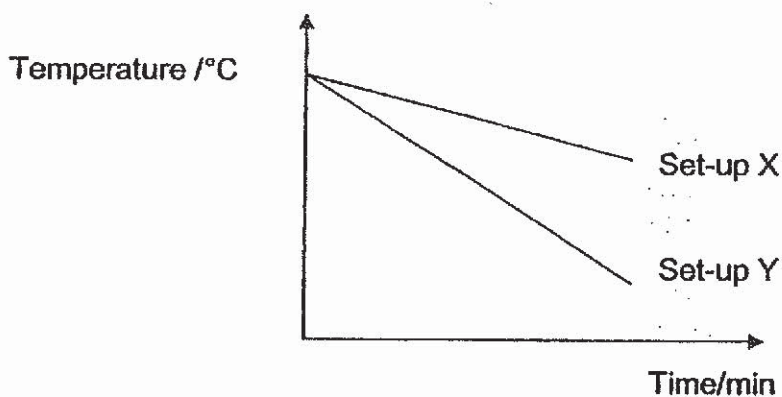

Which one of the following describes the use of material A or B correctly?

- (1) Material A can be used to make an ice box to reduce the rate of ice melting.
- (2) Material A can be used to make a cooking pot as it is a better conductor of heat.
- (3) Material B can be used to make the handle of a cooking pot as it is a poorer conductor of heat.
- (4) Material B can be used to make a lunchbox as it can keep food warmer for a longer period of time.

28. The school installed a pinball machine as shown below to demonstrate how energy can be converted from one form to another. When a pupil pushes the knob, the compressed spring will shoot a metal ball into the maze and finally it rings the bell to signal a score which is lit up on the screen.

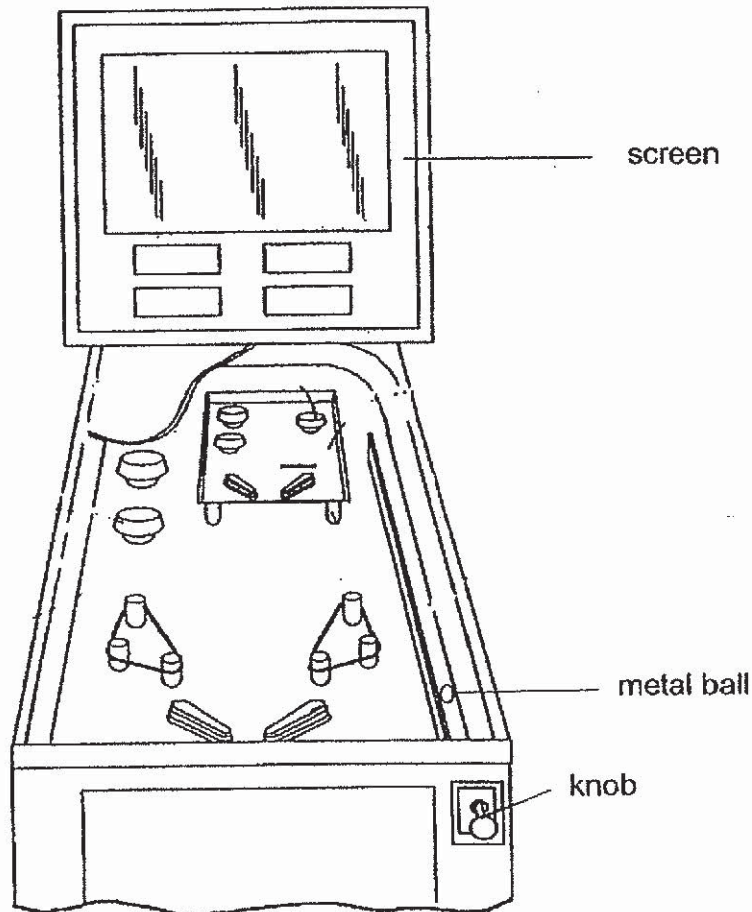

Which one of the following shows the energy conversion when a pupil pulls the knob until a point is scored on the screen?

- (1) kinetic energy  $\rightarrow$  electrical energy  $\rightarrow$  sound energy + light energy
- (2) elastic potential energy  $\rightarrow$  kinetic energy  $\rightarrow$  sound + light energy
- (3) elastic potential energy  $\rightarrow$  electrical energy  $\rightarrow$  kinetic + sound energy
- (4) kinetic energy  $\rightarrow$  elastic potential energy  $\rightarrow$  kinetic  $\rightarrow$  sound + light energy

**SECTION B (44 marks)**

For questions 29 to 41, write your answers clearly in the spaces provided. The number of marks available is shown in the brackets [ ] at the end of each question or part question.

29. Diagrams 1 and 2 show the plant reproductive system and the female human reproductive system respectively.

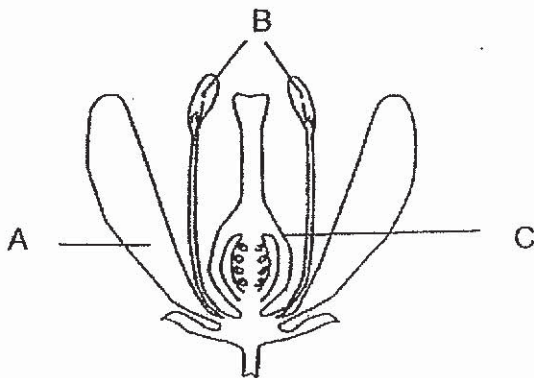

Diagram 1

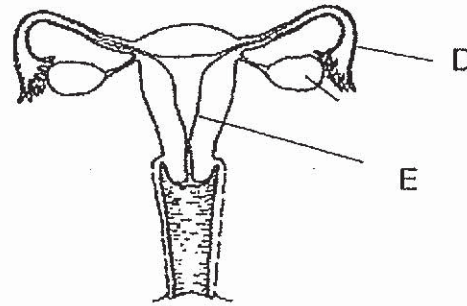

Diagram 2

- (a) In diagram 1, which parts of the flower, A, B, C, can be removed such that the flower can still develop into a fruit? Explain your answer. [2]

---



---

- (b) Based on the two diagrams above, which parts, A, B, C, D, E, correctly identify where fertilisation takes place in the plant and human reproductive systems? [1]

---



---

Score	3
-------	---

30. The diagram below shows how substances are moved from one system to another in a human body.

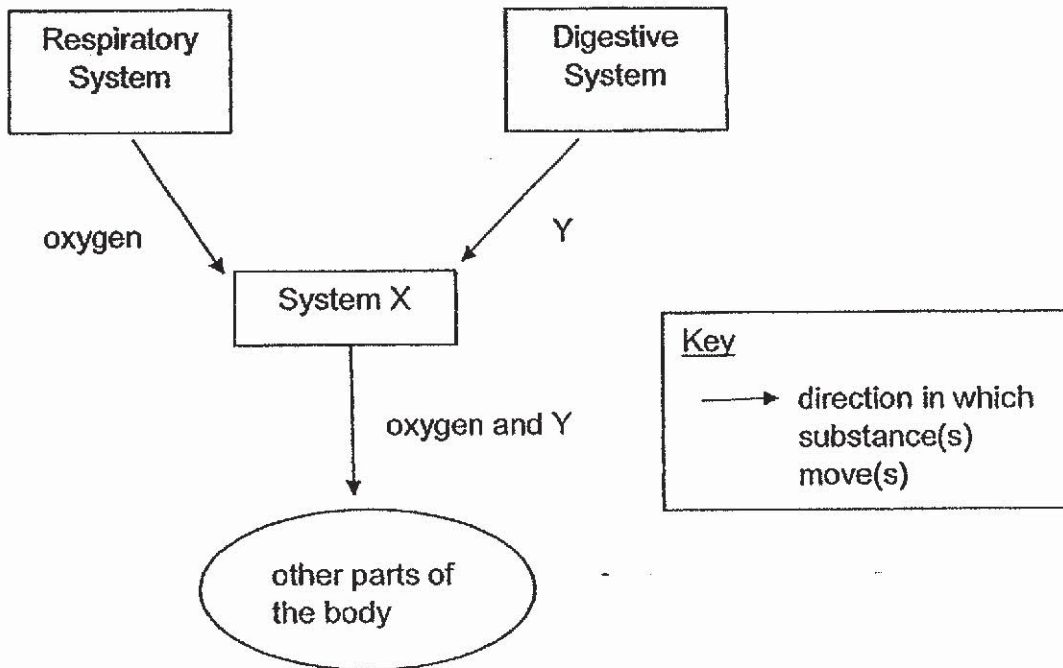

- (a) Which system in the human body best represents X? [1]

---

- (b) What is the substance Y after digestion? [1]

---

- (c) Explain why oxygen and substance Y are needed to be transported to other parts of the body. [1]

---

---

Score	3
-------	---



31. The diagram below shows the cross-section of a pond.

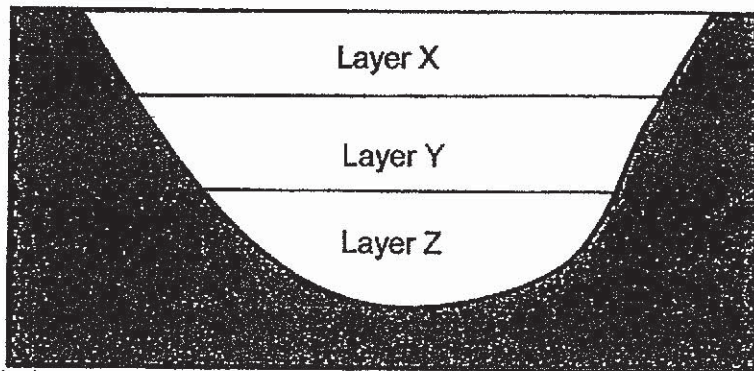

The table below shows the temperature and the number of organisms found in the different layers of the pond.

Layer of the pond	Temperature of pond (°C)	Number of organisms
X	18 to 24	22
Y	7 to 17	14
Z	4 to 6	4

(a) Based on the information above, what is the relationship between the temperature of the pond and the number of organisms in it? [1]

---

(b) The graph below show how light intensity changes with depth of the pond.

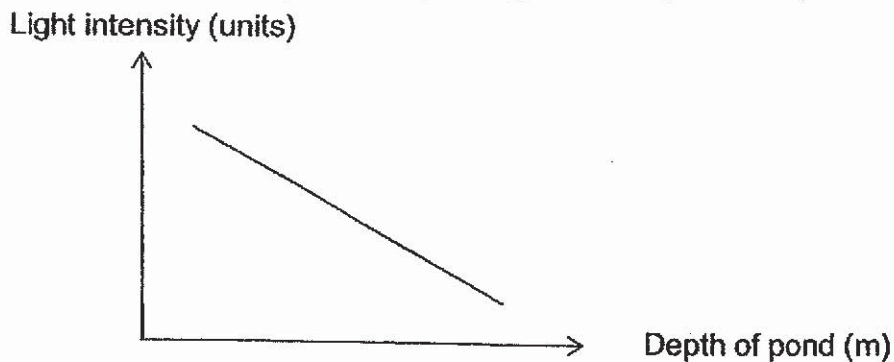

Based on the information above, what will happen to the number of organisms in the pond as the light intensity in the pond decreases? [1]

---



---

Score	2
-------	---

Continue on next page



Continued from previous page

- (c) The number of plants floating on Layer X of the pond increases significantly. What would happen to the number of animals in Layer Z if they feed on Plants in Layer Z? Explain your answer. [2]

---



---

32. The graph below shows the population of plant A in a garden. Animal B was introduced into the garden at point X.

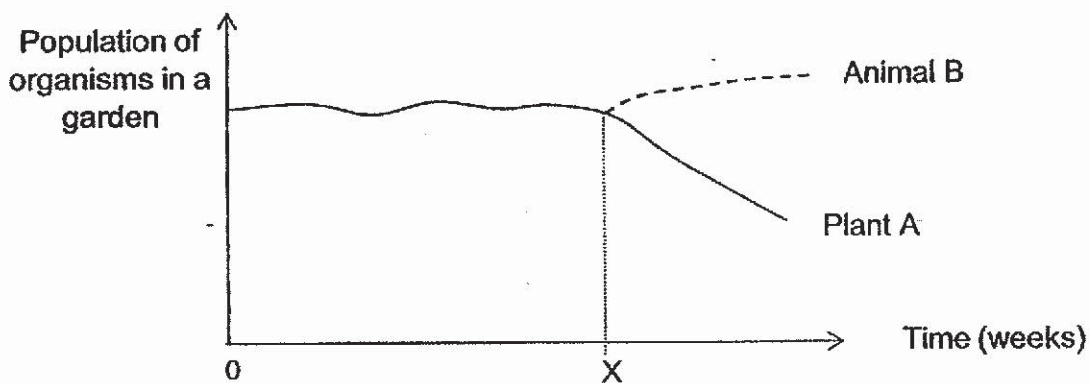

- (a) Based on the information above, if Animal C feeds on Plant A and Animal B, draw arrows to complete the food web below. [1]

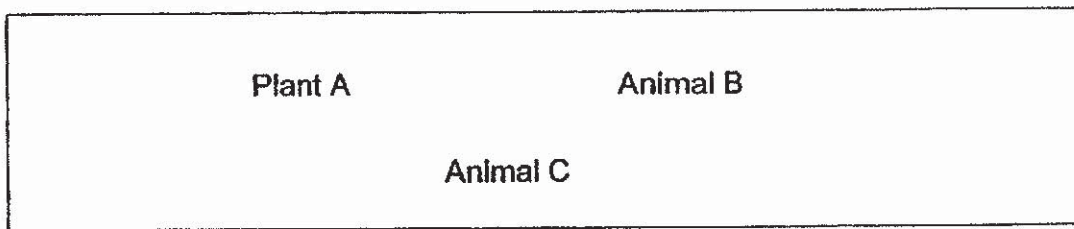

- (b) Fill in the letters A, B and/or C in the boxes below. [1]

Prey(s)	Predator(s)

Score	4
-------	---

Continue on next page

Continued from previous page

- (c) What would happen to the population size of Animal B if population of Animal C was wiped out by a disease? Explain your answer. [2]

---

---

33. Chloe set up an experiment with four similar pots of plants, as shown below. The plants were placed in a dark room for forty-eight hours before the start of the experiment. All the boxes were of the same size but made of two different materials, Y and Z. Chemical X in set-ups P and Q absorbed carbon dioxide. The boxes were left in the sun for three hours.

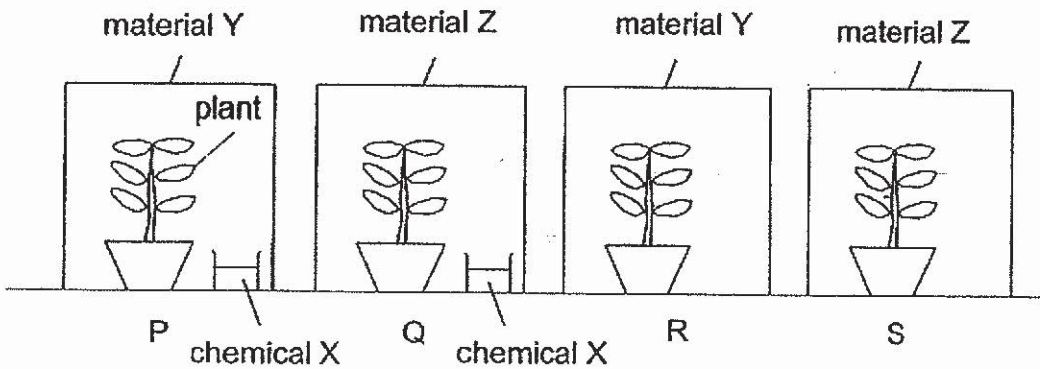

After three hours, starch test was performed on the leaves from each set-up. Only the leaves in set-up R showed the presence of starch.

- (a) Identify the property of material Z. Explain your answer. [2]

---

---

- (b) Which pair of set-ups can be used to show carbon dioxide is needed for photosynthesis to take place? Explain your answer. [2]

---

---

Score	6
-------	---

34. Bryan and his friends carried out the experiment below to obtain water from sea water.

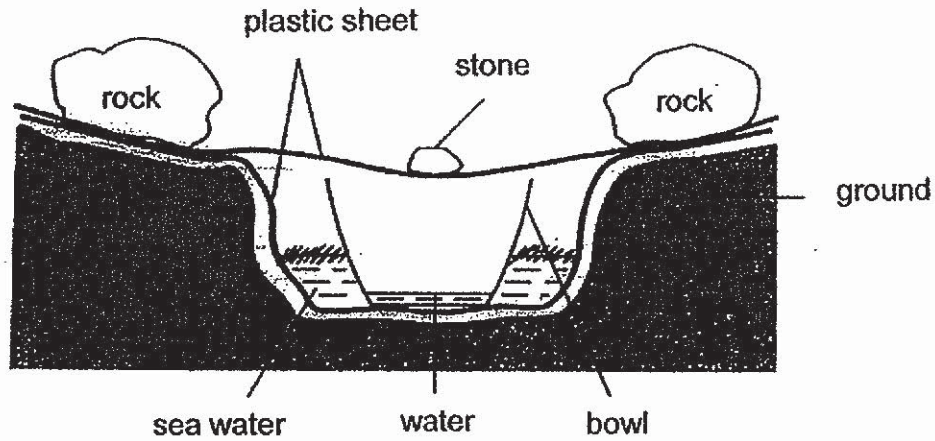

(a) What would happen to the amount of water collected in the bowl if Bryan and his friends replaced the bowl with a smaller one? [1]

---

(b) Explain your answer in (a) [2]

---

---

Score	3
-------	---

35. Maison has a toy that works on batteries as shown in the diagram below.

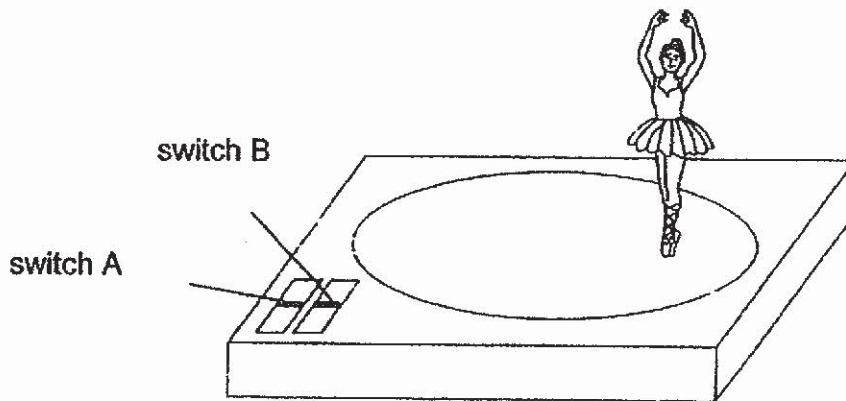

She recorded her observations in the table below when she turned on the switches.

Switches which were turned on	Observation
Both A and B	Dancer moved in a circle with music.
A only	Dancer did not move. There was music.
B only	Dancer moved in a circle. There was no music.

Maison drew a diagram to represent how the parts of the toy are connected in an electrical circuit.

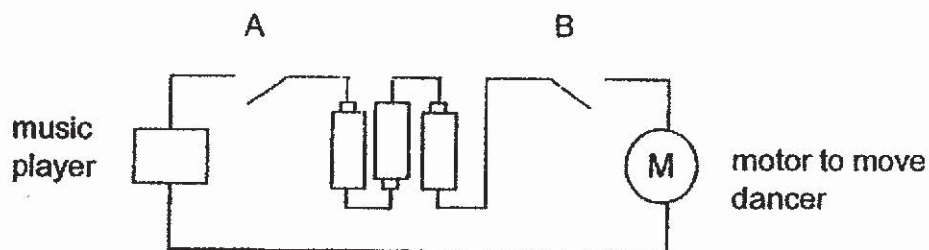

(a) Maison's teacher told her that her circuit diagram was incorrect. Explain why it was incorrect. [2]

---



---

Score	2
-------	---

Continued from previous page

(b) In the space provided, draw 3 wires to complete the arrangement correctly below to show the observations made by Maison. [2]

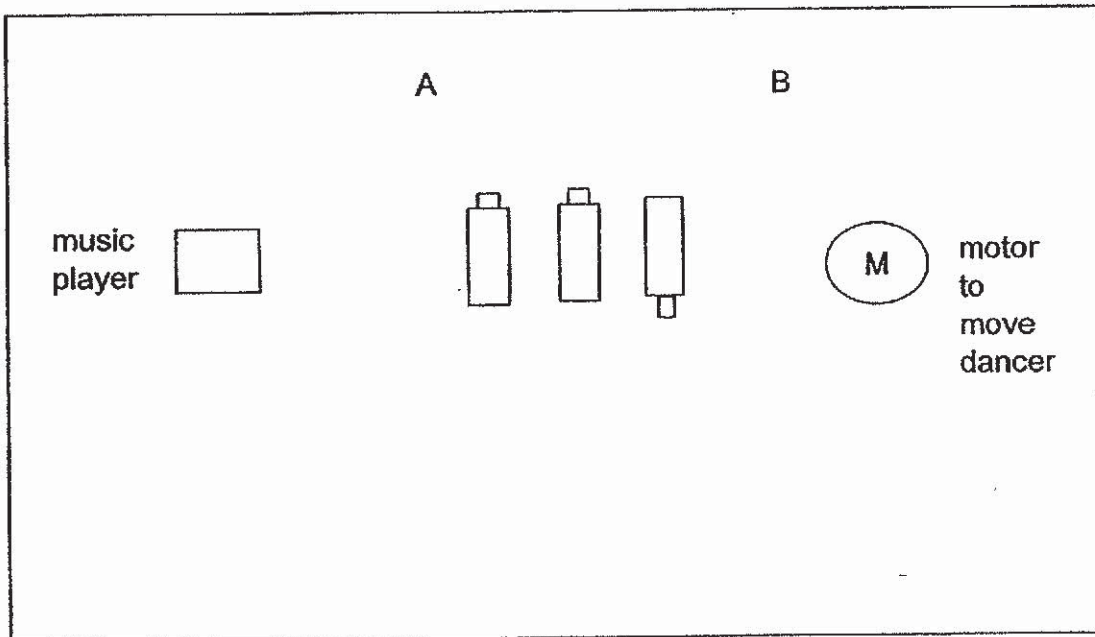

Score	2
-------	---



36. Ahmad taped a bar magnet with poles X and Y, onto a piece of styrofoam block and spun it ten times in a basin of water. The diagram below shows the top view of the set-up when the magnet was at rest. The bar magnet always came to rest in the direction as shown in the diagram below.

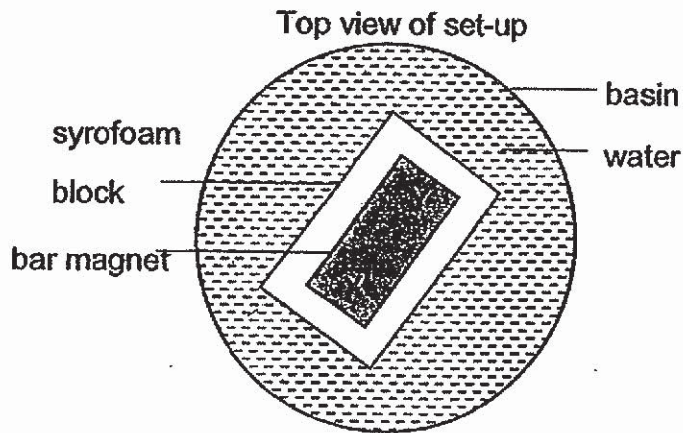

The direction North is shown in the compass below.

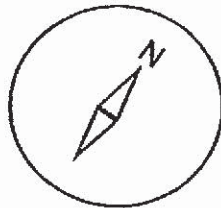

- (a) Based on Ahmad's results, which property of magnets is shown in his observation? [1]
- (b) The diagram below shows the bar magnet placed near a compass.

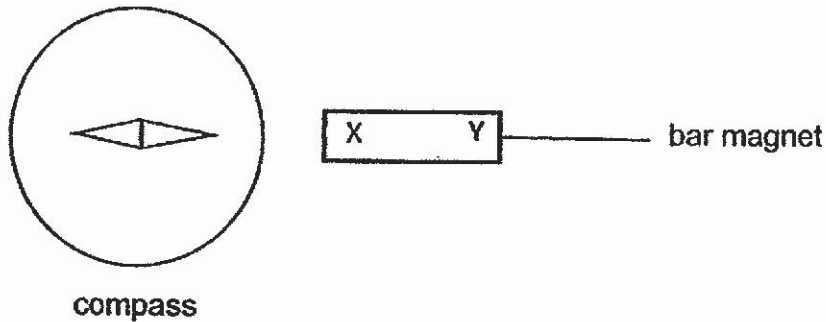

Label the needle of the compass 'N' for north or 'S' for south when the magnet is placed near it as shown in the diagram above. Explain your answer. [2]

Score	3
-------	---



37. Some pupils carried out an experiment to find out how different loads hung on Springs A and B affect the length of two springs. The results are shown in the graph below.

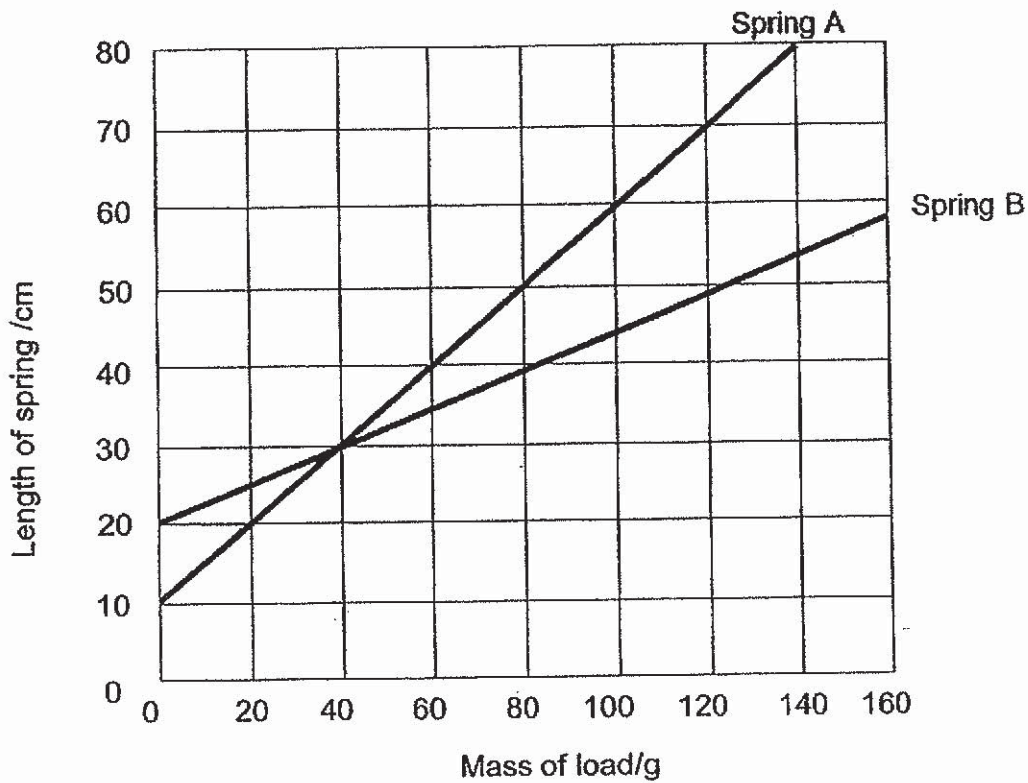

- (a) What is the length of Spring A when 40 g load is added to Spring A? [1]
- 
- 
- (b) Which Spring, A or B, will extend more when 100g load is added? [1]
- 
- (c) Based on the graph above, what is the relationship between the length of the spring and the mass of the load added? [1]
- 

Score	3
-------	---

38. Mrs. Lee set up an experiment using two identical strong magnets as shown in the diagram below. Both Magnets A and B have a weight of 1 N each. (N stands for Newtons which is the unit for force).

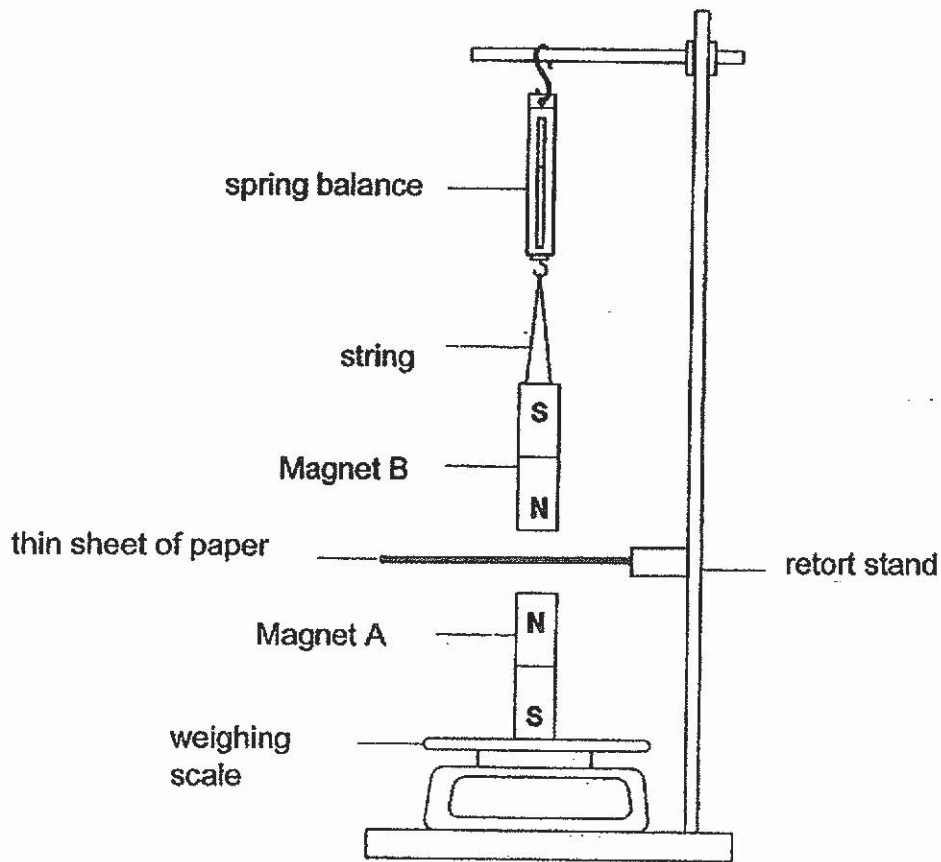

- (a) Based on the experiment above, what is/are the force(s) acting on Magnet B? [1]
- 
- (b) What readings will be shown on the weighing scale and spring balance?  
( less than 1 N, 1 N or more than 1N) [1]
- (i) Reading on weighing scale \_\_\_\_\_
- (ii) Reading on spring balance \_\_\_\_\_
- (c) What is most likely to be the reading on the weighing scale if the thin sheet of paper is replaced with a piece of steel sheet? Explain your answer. [1]
- 

Score	3
-------	---

39. Andy set up an experiment to investigate the degree of transparency of four different materials. The diagram below shows Andy's experiment set-up.

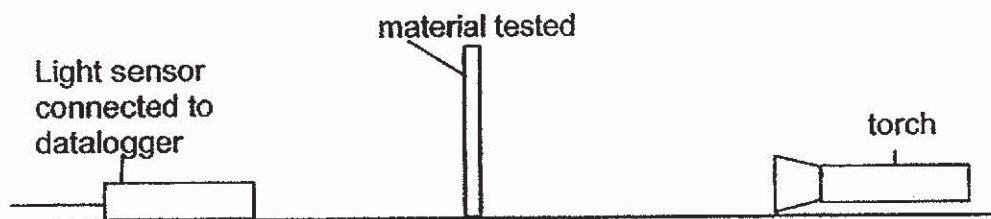

The light sensor and torch were switched on throughout the experiment. First the reading was taken without the material placed in the set up for the first two seconds. Then the material was placed in the set up and the reading was recorded for the next two seconds before it was removed. After an interval of two seconds, the next material was placed in the set-up.

The graph below shows the amount of light detected by the light sensor, 1000 units indicate the amount of light when no material was placed in the set-up.

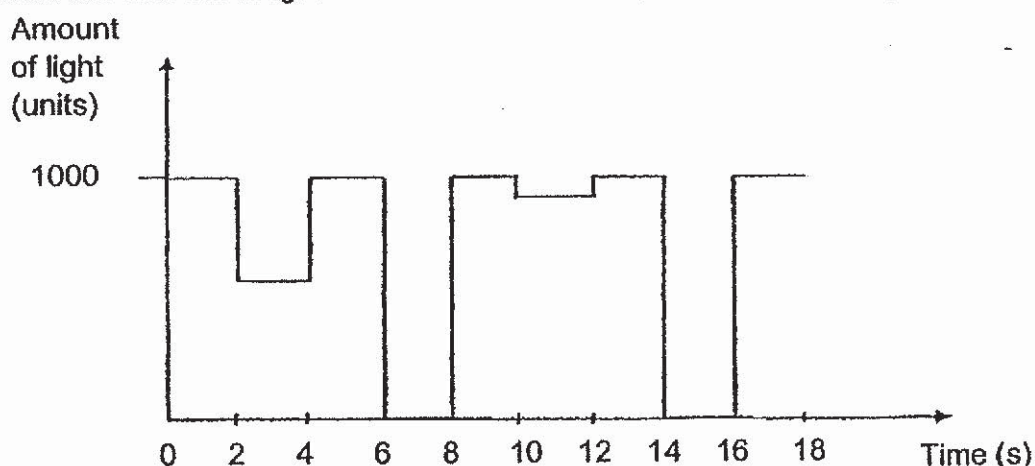

- (a) Based on the graph, determine the sequence of materials tested in Andy's experiment by putting 1 as the first material tested and 4 as the last material tested. [2]

Material	Sequence of material tested
aluminium foil	
clear glass	
frosted glass	
mirror	

- (b) Explain your choice of material from 6 s to 8s time interval. [1]

---

Score	3
-------	---

40. Three identical beakers of water at different temperatures were placed side by side as shown below during a Science experiment.

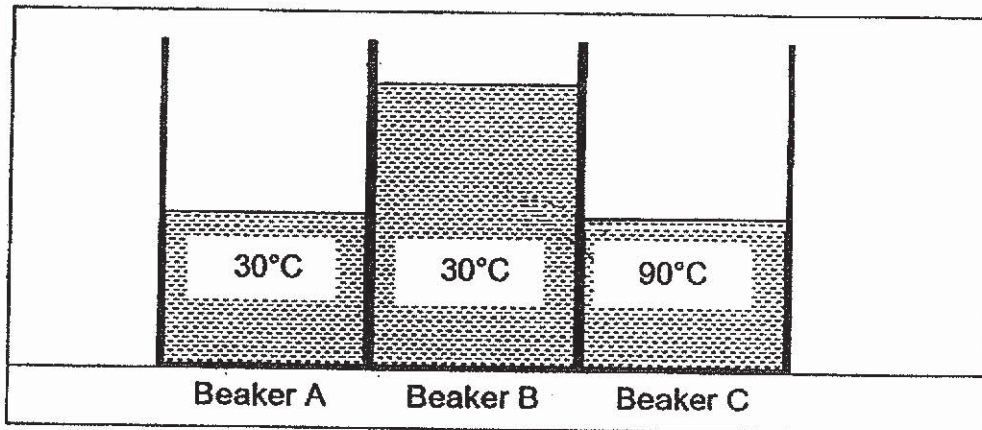

- (a) On the diagram above, draw an arrow to indicate the direction of heat transfer between water in beaker B and C at the beginning of the experiment. [1]
- (b) Compare the amount of heat energy in beakers A and B at the beginning of the experiment. Explain your answer. [1]

---



---

- (c) The teacher told her pupils to mix water from beaker A and beaker C together into one beaker as shown below.

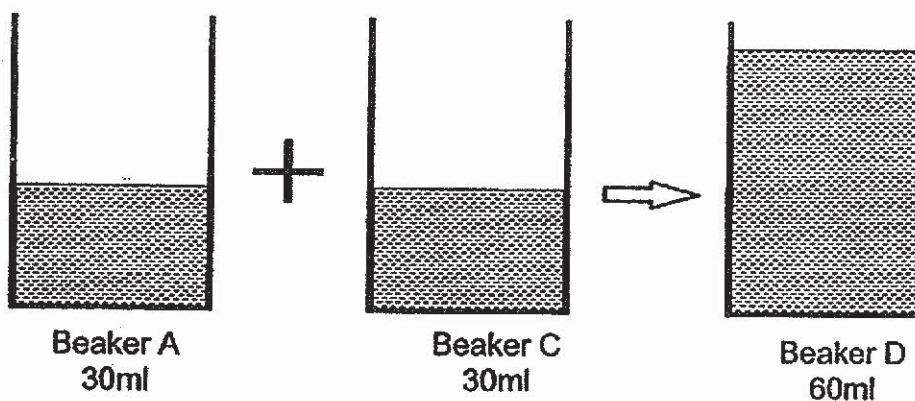

- (d) What is likely to be the temperature of water in Beaker D? [1]

---

Score	3
-------	---



41. A pail of water was hung above a basin as shown below. A very small hole was made at the bottom of the pail for the water to drip into the basin. A sound was produced each time as each water droplet fell on the basin.

Gerald placed a datalogger with sound sensor near the basin, the following graph was displayed on the datalogger screen.

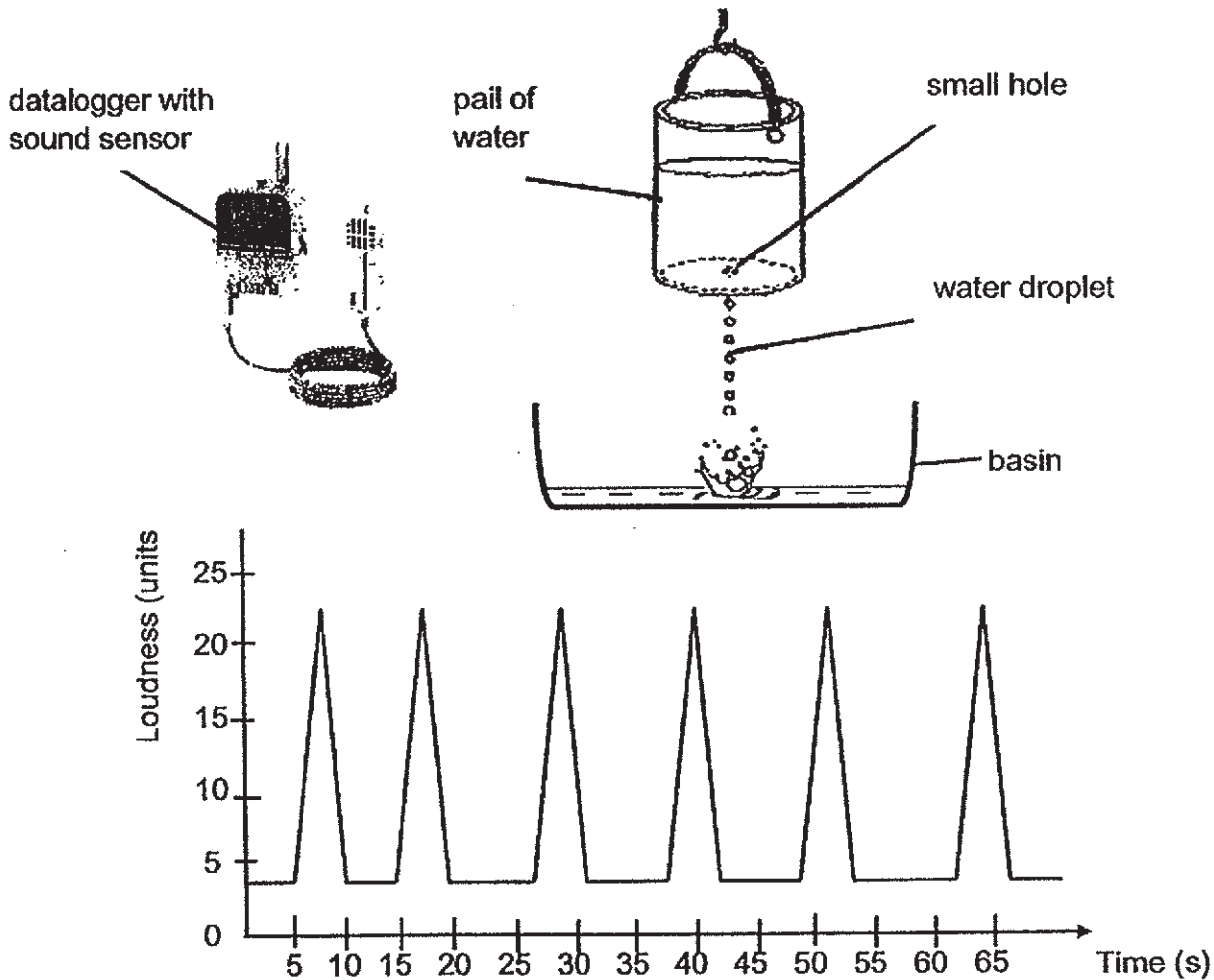

- (a) Fill in the blanks to show the main energy conversion when the water droplets fell into the basin. [1]

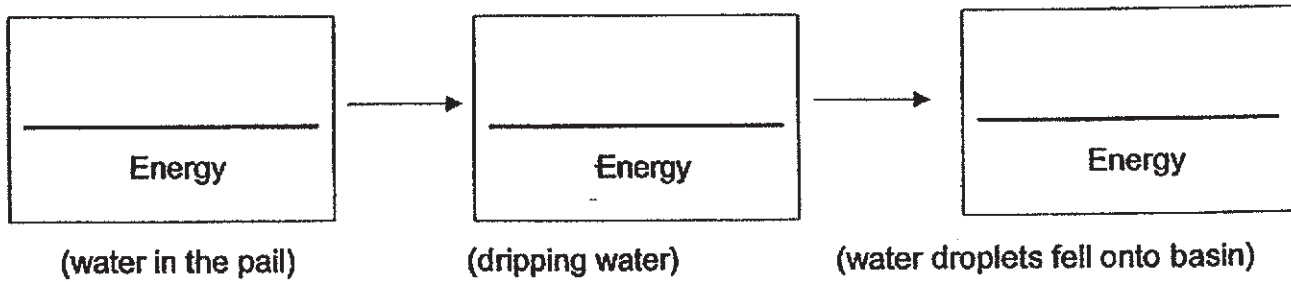

Score	1
-------	---

Continue on next page

Continued from previous page

- (b) What happened to the loudness indicated by the sound sensor if Gerald raised the pail of water higher from the basin? Explain your answer. [2]

---

---

Gerald modified the experiment set-up without changing the height of the pail of water and obtained the results as shown in the graph below.

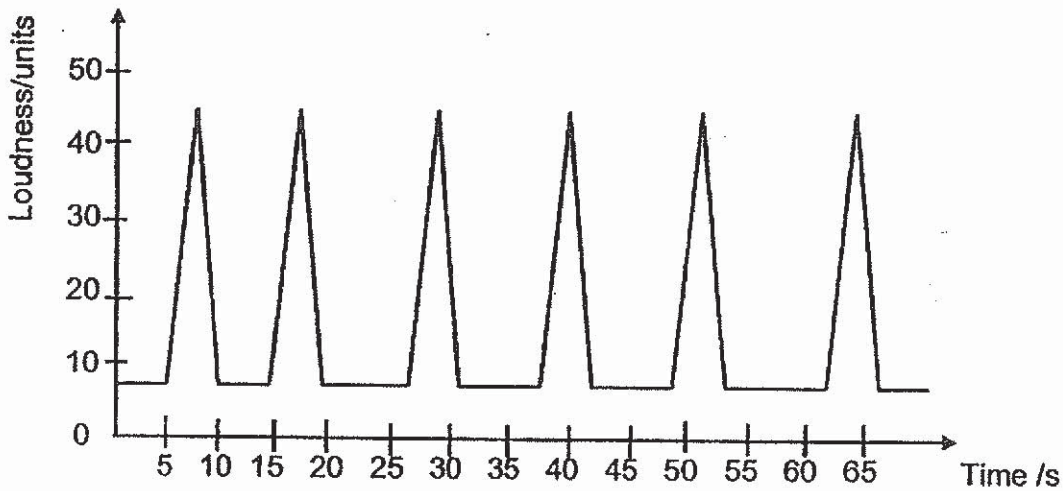

- (c) Suggest how Gerald could modify the experiment set-up to obtain the results as shown in the graph above. [1]

---

---

End of Paper

Score	3
-------	---





SCHOOL : RAFFLES GIRLS' PRIMARY SCHOOL  
 LEVEL : PRIMARY 6  
 SUBJECT : SCIENCE  
 TERM : 2019 SA1

**SECTION A**

Q 1	Q2	Q3	Q4	Q5	Q6	Q7	Q8	Q9	Q10
3	3	1	3	3	1	3	3	1	4
Q 11	Q12	Q13	Q14	Q15	Q16	Q17	Q18	Q19	Q20
4	1	1	1	2	3	2	3	2	3
Q 21	Q22	Q23	Q24	Q25	Q26	Q27	Q28		
3	2	2	4	4	4	1	4		

**SECTION B**

Q29)	<p>a)Part A and B. The stigma on the flower can still receive pollen grains from another flower. Hence fertilization can still occur/Hence fertilization can still fuse with the female reproductive cell.</p> <p>b)C and D.</p>
Q30)	<p>a)Circulatory system.</p> <p>b)digested food.</p> <p>c)To provide energy for the human.</p>
Q31)	<p>a)The higher the temperature of the pond, the greater the number of organisms.</p> <p>b)The number of organisms in the pond would decrease.</p> <p>c)The population of Animals in Layer Z which feeds on the plants living in Z will decrease too due to lack of plants to feed on.</p>

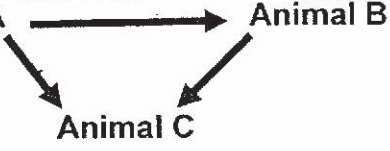
Q32)	<p>a) </p> <p>b) B / C</p> <p>c) The population of Animal B will increase. As there would be no predator animal C, to prey on animal B. There will also be more food, plant A for animal B since there will be no animal C feeding on plant A.</p>
Q33)	<p>a) It does not allow light to pass through. Starch is produced when the plant can photosynthesise. If the plant in set-up Q was not able to produce starch, that meant that it was not able to photosynthesise. Photosynthesis can only take place when light is present.</p> <p>b) Set-up P and R. The plant in set-up R was able to photosynthesise, meant that material Y allows light to pass through, so by using set-up P made of material Y, and there is chemical X inside which absorbs carbon dioxide and there is no chemical X inside set-up R, Hence, set-up P and R can be used to show carbon dioxide is needed for photosynthesis to take place.</p>
Q34)	<p>a) The amount of water collected would be greater.</p> <p>b) When a smaller bowl was used. The exposed surface area of the sea water increased. Hence, more water will (gain heat and )evaporate, higher rate of evaporation more water vapour condensed into more water droplets on the plastic sheet which will be collected in the bowl.</p>
Q35)	<p>a) When either A or B is switched off, it formed an open circuit, no electricity, no light and neither dance nor the music will work.</p>

b)

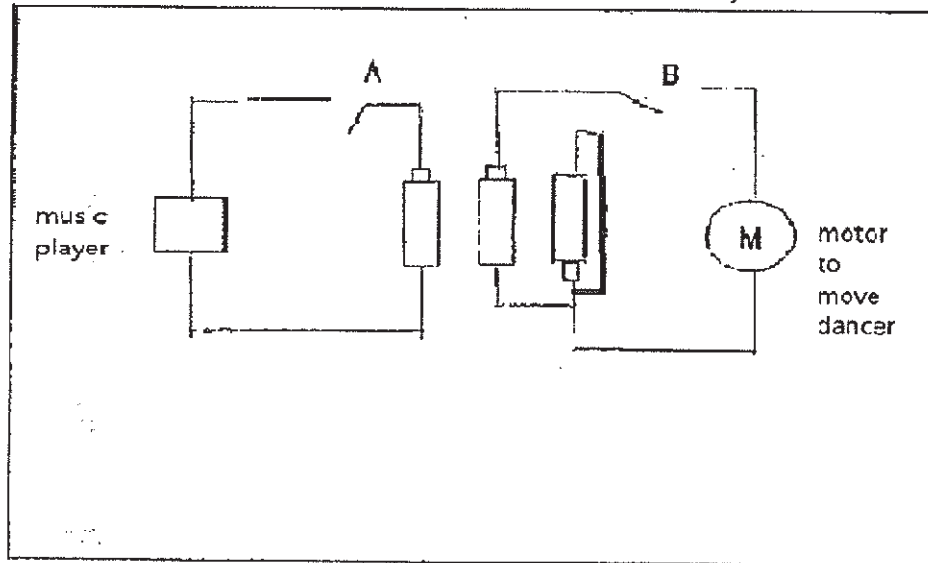

Q36) a) A freely suspended magnet will come to rest in a north-south direction.  
 b) Unlike poles of the bar magnet and needle are facing each other and they attract.

Q37) a) 30cm  
 b) spring A  
 c) The heavier the mass of the load added, the longer the length of the spring.

Q38) a) Elastic potential energy, magnetic force.  
 b) i) more than 1N.  
 ii) less than 1N.  
 c) 1N. Magnetic force acts through the steel sheet which is a magnetic material. There is no magnetic force of repulsion acting on the spring scale.

Q39) a) 2, 3, 1, 4  
 b) The material is opaque, as there was no light detected by the light sensor, stating that the material did not allow light to pass through.

Q40)

a)

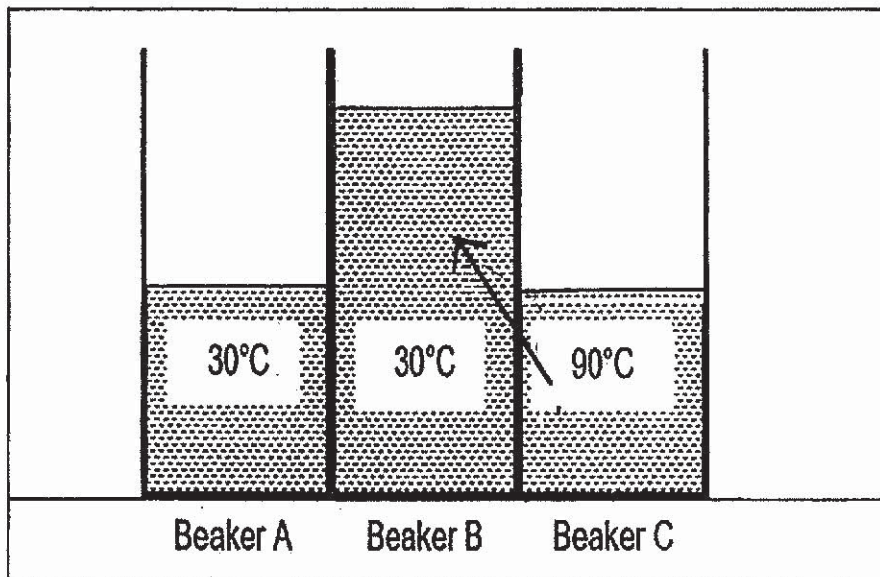

b) There was less heat energy present in the water of beaker A than beaker B because it had smaller amount of water.

d) 60°C

Q41)

a) gravitational potential → kinetic energy → sound energy

b) The higher the pail of water was dropped, the greater gravitational potential energy of the water converted to more kinetic energy which will be converted to more sound energy.

c) He made a bigger hole at the bottom of the pail.