



HENRY PARK PRIMARY SCHOOL

PRELIMINARY ASSESSMENT 2019

PRIMARY 6

SCIENCE

BOOKLET A (56 MARKS)

INSTRUCTIONS TO CANDIDATES

1. Do not turn over this page until you are told to do so.
2. Follow all instructions carefully.
3. Answer all questions.
4. Shade your answers on the Optical Answer Sheet (OAS) provided.

Name: _____ ()

Class: Primary 6 ()

Date: 27 August 2019

Total Time: 1 h 45 min

Booklet	Marks	
A		/ 56
B		/ 44
Total (A+B)		/ 100

Parent's Signature: _____

Booklet A (56 marks)

For each question from 1 to 28, four options are given. One of them is the correct answer. Make your choice (1, 2, 3 or 4). Shade the correct oval (1, 2, 3 or 4) on the Optical Answer Sheet.

1. Oliver observed a group of living things under a microscope over 4 days.

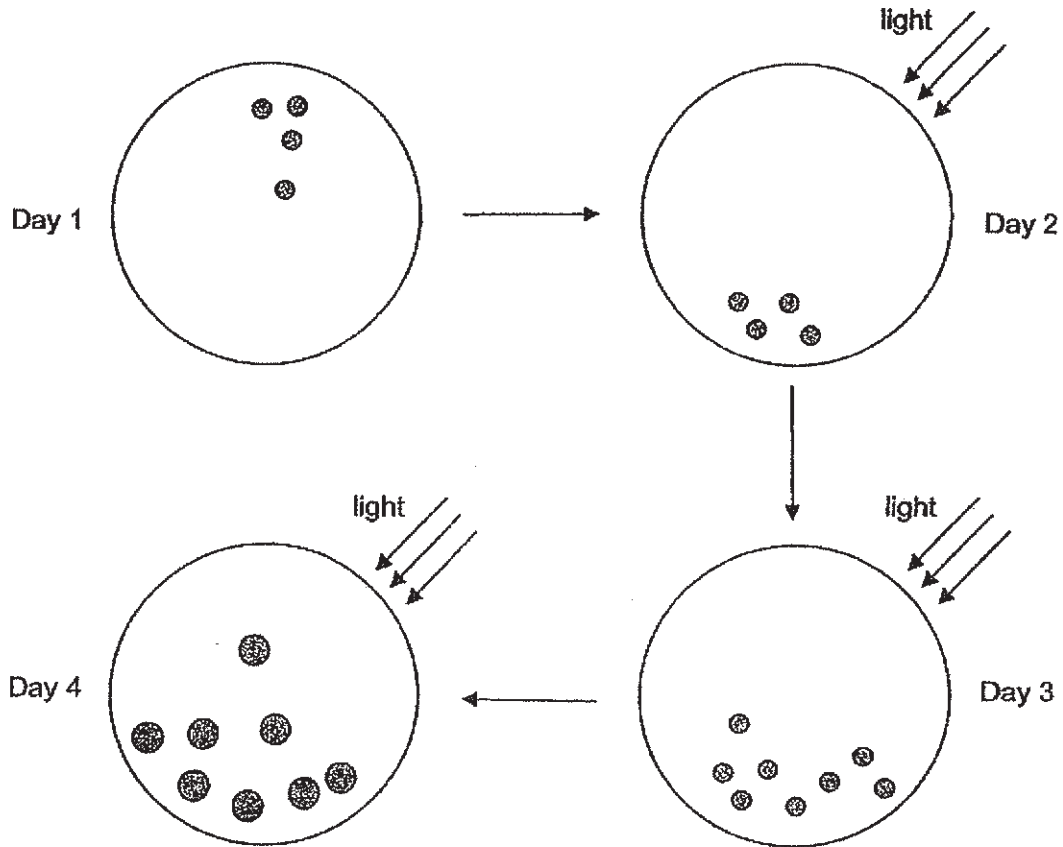

Which of the following characteristics of living things did he observe over the 4 days?

- A: Living things can grow.
- B: Living things need food.
- C: Living things can respond.
- D: Living things can reproduce.

- (1) A, B and C only
- (2) A, C and D only
- (3) B, C and D only
- (4) A, B, C and D

()

2. John made a list of common characteristics observed in reptiles and amphibians, as shown in the table below.

Which of the following comparisons of the characteristics between the amphibians and reptiles is/are correct?

	characteristic	amphibians	reptiles
A	breathing method	through gills	through gills
B	outer body covering	moist skin	dry scales
C	reproduction method	give birth	lay eggs

- (1) B only
 (2) A and B only
 (3) A and C only
 (4) A, B and C

()

3. The diagram below shows a process during a stage in the life cycle of a flowering plant.

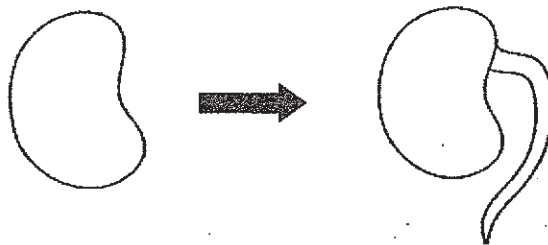

Which of the following is correct about the process that is taking place at this stage of the life cycle of the flowering plant?

	Process	Gas taken in	Gas given off	Light needed	Warmth needed
(1)	fertilisation	carbon dioxide	oxygen	yes	no
(2)	fertilisation	carbon dioxide	oxygen	yes	yes
(3)	germination	oxygen	carbon dioxide	no	yes
(4)	germination	oxygen	carbon dioxide	yes	yes

()

4. The diagram shows the human digestive system.

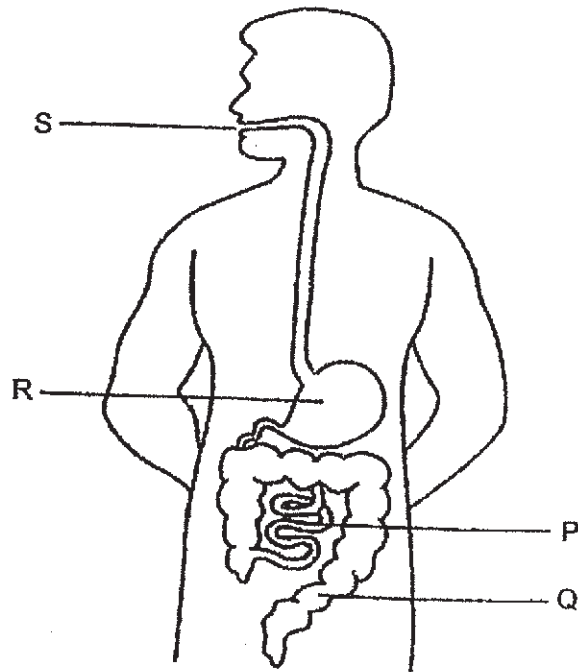

In which one of the following parts is water absorbed from the undigested food?

- (1) P
- (2) Q
- (3) R
- (4) S

()

5. The diagram below shows that plant A has climbed around plant B.

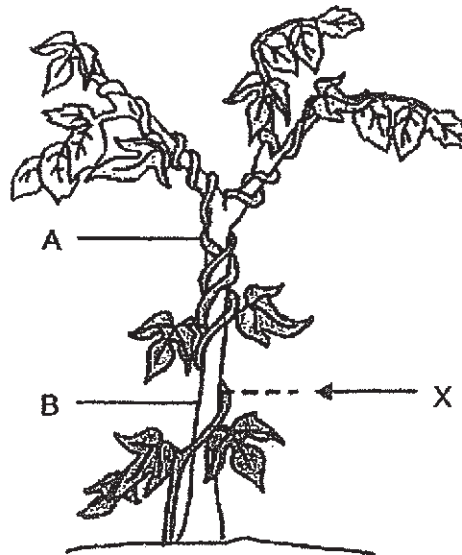

The stem of plant A was cut off at X.

Which one of the following explains what is likely to happen to the part of plant A above X after some time?

	Part of plant A above X	Main reason
(1)	died	has no water to make food
(2)	died	has no support from plant B
(3)	died	cannot get light to make food
(4)	survive	can still get water to make food

()

6. Study the table below.

	Parts of the respiratory system			
	A	B	C	D
air passes through here		✓	✓	
air from the surrounding enters here				✓
gaseous exchange takes place here	✓			

Key: ✓ present

Which of the following correctly shows the parts labelled, A, B, C and D?

(1)

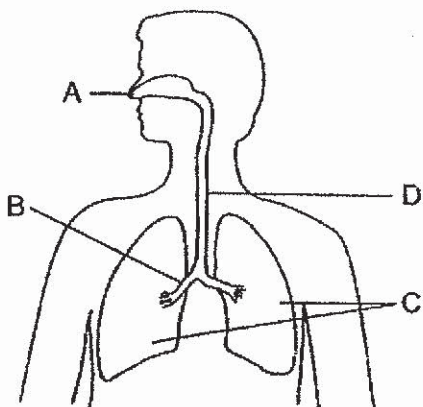

(2)

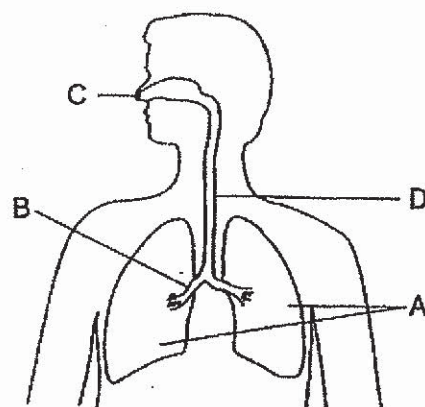

(3)

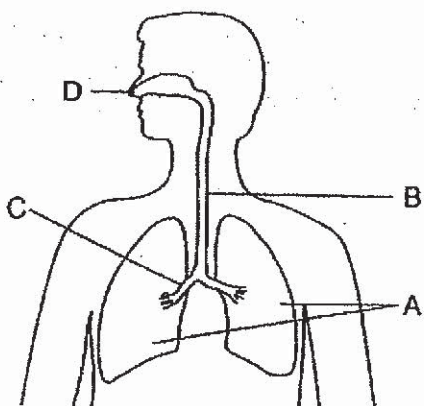

(4)

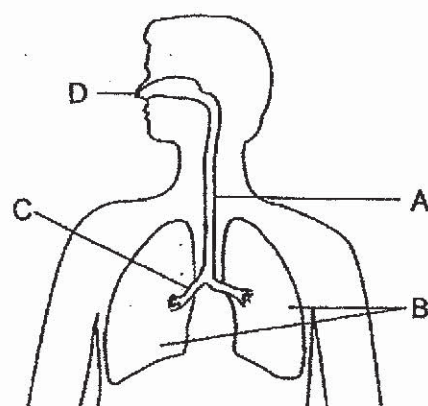

()

7. The diagram below shows tree Q at the bottom of a hill.

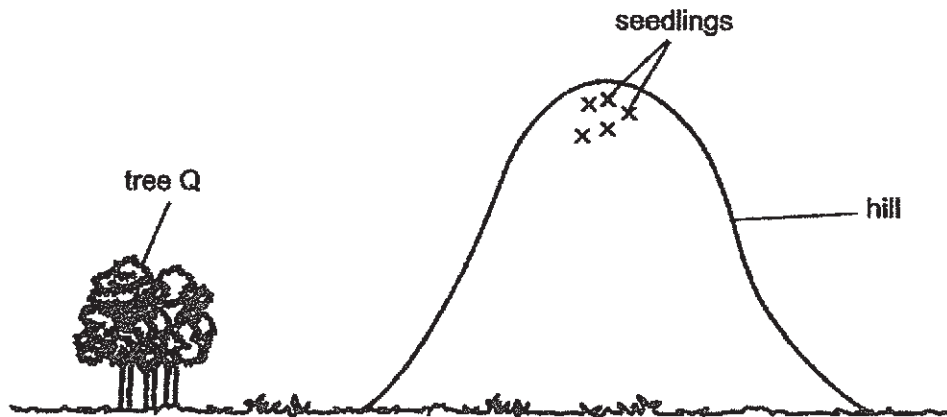

After some time, seedlings of tree Q were found growing on the hill as shown in the diagram above.

Which of the following are possible characteristics of the fruits of tree Q?

- A: has dry pods
- B: has fibrous parts
- C: has wing-like parts
- D: has fleshy edible parts

- (1) A and C only
- (2) C and D only
- (3) A, B and D only
- (4) B, C and D only

()

8. Two types of cells are shown below.

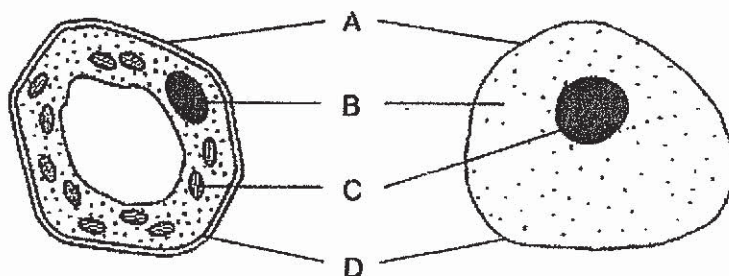

Study the table below.

Part of cell	Function
A	gives the cells a fixed shape
B	controls activities in the cells
C	gives the cells a green colour
D	controls substances entering the cells

Which one of the parts labelled, A, B, C or D, and its function is correct for both cells?

- (1) A
- (2) B
- (3) C
- (4) D

()

9. Which of the following activities help to keep the environment clean and green?

- A: drive to a nearby destination
- B: turn unwanted vegetable parts into fertiliser
- C: bring your own bag during shopping
- D: turn on the air-conditioners all the time

- (1) B and C only
- (2) A, B and D only
- (3) B, C and D only
- (4) A, B, C and D

()

10. Yasmeen placed substance X in a glass jar and conducted an experiment as shown below.

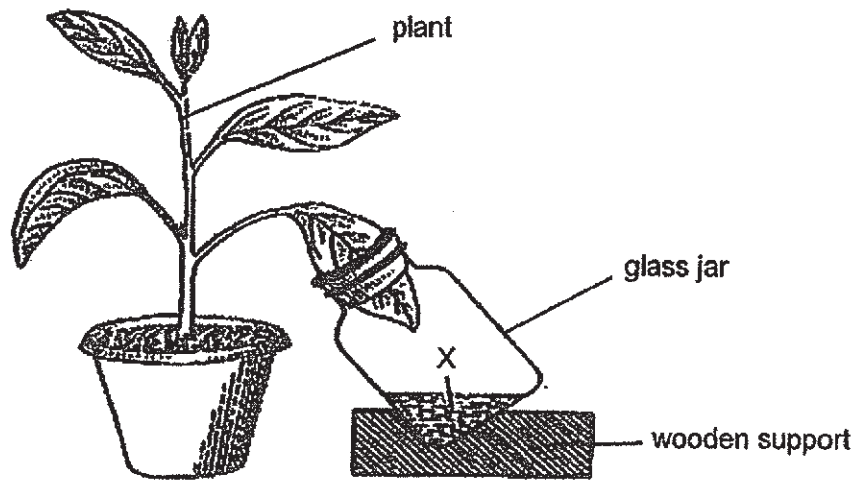

She then tested the leaf for starch using iodine solution. The result of her experiment is as shown below.

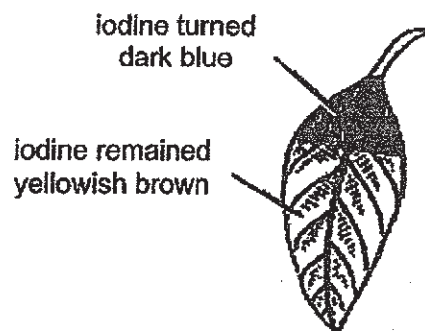

What did substance X do in this experiment?

- (1) absorb oxygen
- (2) give out oxygen
- (3) absorb carbon dioxide
- (4) give out carbon dioxide

()

11. A group of researchers was investigating the changes in the population of land animals in Singapore over a period of 30 years. They noted a decrease in the population of land animals over time.

Which of the following factor(s) is/are most likely to have caused the decrease in the population of these animals?

A: deforestation

B: increased sunlight

C: introduction of other animals

(1) A only

(2) A and B only

(3) A and C only

(4) B and C only

()

12. Alice studied a community living on a rotting log. She found the following organisms:

ants	millipede	mould	toadstool
------	-----------	-------	-----------

Which one of the following classification is correct?

	Decomposers	Organisms that help decomposers
(1)	ants, toadstool	millipede, mould
(2)	mould, toadstool	ants, millipede
(3)	millipede, mould	ants, toadstool
(4)	millipede, mould, toadstool	ants

()

13. The following diagram shows a food web in a particular habitat.

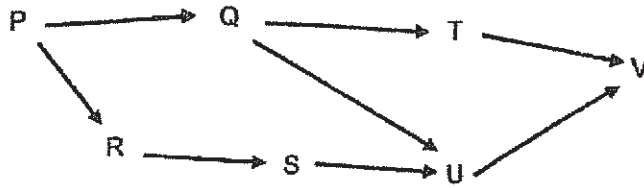

Which of the following organisms are both a prey and predator?

- (1) Q and U
- (2) R and S
- (3) S and T
- (4) U and V

()

14. The diagram below shows animal X. It has a hard outer covering and lives in the seashore habitat.

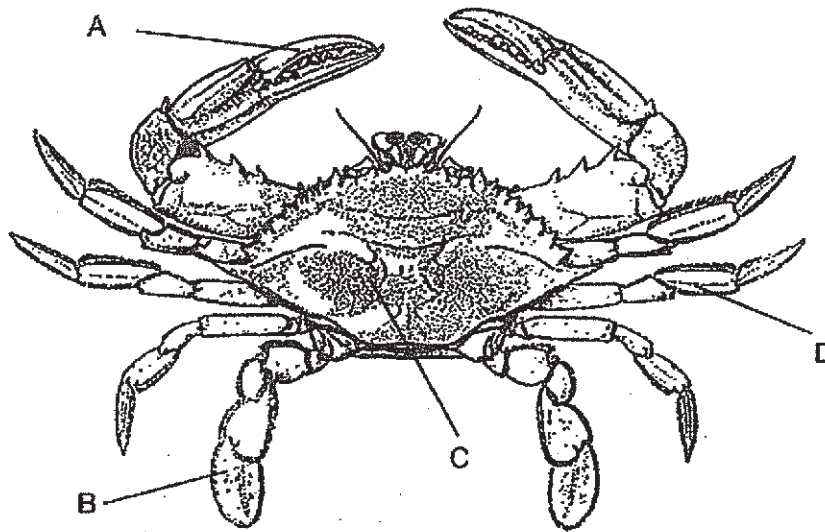

Which of the following is correct about the function of the parts labelled, A, B, C and D?

	For moving around	For protection
(1)	A	B, C and D
(2)	A, B and D	C
(3)	A and C	B and D
(4)	B and D	A and C

()

15. The diagram below shows two cardboard boxes, A and B, of the same size but of different thickness.



Box A

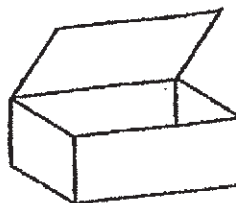

Box B

Zachary used box A to send a heavy parcel. He also wrapped it up with a clear plastic as shown in the diagram below.



Box A wrapped in clear plastic

Why did Zachary choose box A and wrap it up with clear plastic?

Reason for	
using box A	wrapping box A with a clear plastic
(1) heavier	to allow most light to pass through
(2) stronger	to make it flexible
(3) stronger	to make it waterproof
(4) more flexible	it is a poor conductor of heat

()

16. In an experiment, Yue Ling filled a glass container with marbles until she could not put any more marbles into it. She concluded that there was no more space in the container for her to put anything into it.

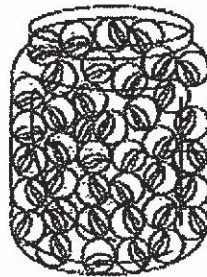

glass container filled with marbles

However, her friend, Sally said that she was wrong.

How could Sally prove that Yue Ling was wrong?

- A: shake the container of marbles
- B: heat up the container of marbles
- C: pour sand into the container of marbles
- D: pour water into the container of marbles

- (1) A and B only
- (2) B and C only
- (3) A, B and C only
- (4) A, C and D only

()

17. Which of the following is correct about heat and light?

- (1) Both help us to see.
- (2) Both are forms of energy.
- (3) Both can be compressed.
- (4) Both occupy space and have mass.

()

18. A bimetallic strip is formed by joining two different metals together. The diagrams below show how the strip bends when it is heated.



Four metals, A, B, C and D, were used in different combinations to form four bimetallic strips. The diagrams below show how each strip bent when heated equally for 5 minutes.



Strip 1



Strip 2



Strip 3



Strip 4

Based on the information given, which of the following shows metals, A, B, C and D, arranged in the correct order, based on how much the metal had expanded when heated?

	Expanded the least \longrightarrow Expanded the most			
(1)	B	C	A	D
(2)	C	A	B	D
(3)	C	B	A	D
(4)	D	A	B	C

()

19. Gopal used three wooden frames, P, Q and R, as shown below for an experiment on shadows.

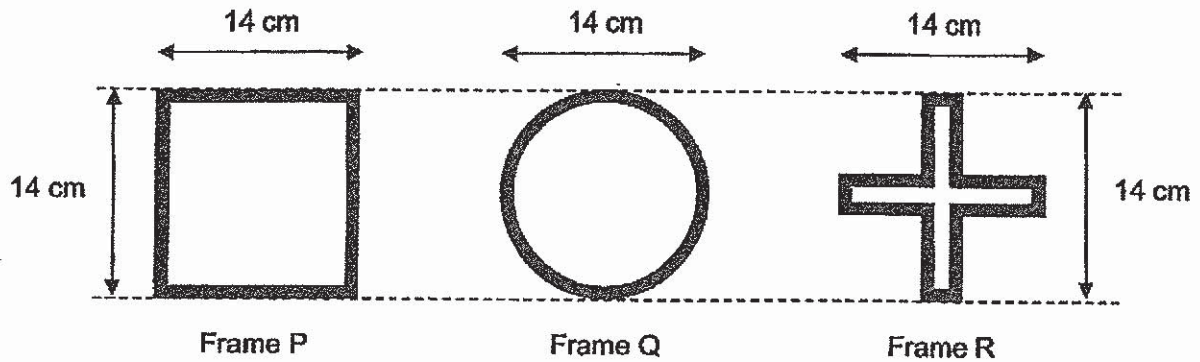

He conducted the experiment in a dark room using the following set-up. The shadows formed on the screen are shown below.

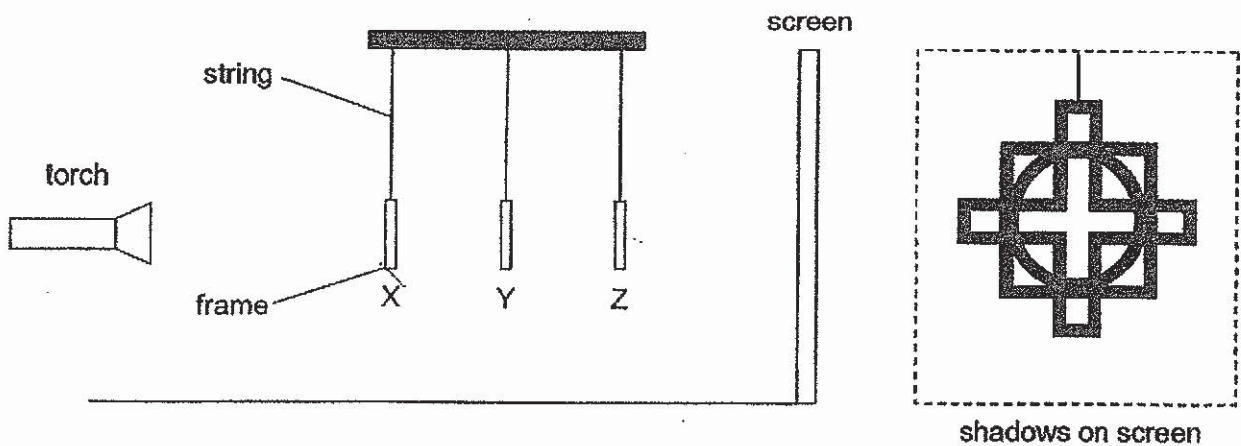

Which of the following shows the correct positions of the wooden frames for the shadows cast on the screen?

	Position of		
	Frame P	Frame Q	Frame R
(1)	X	Y	Z
(2)	Y	Z	X
(3)	Y	X	Z
(4)	Z	Y	X

()

20. Study the diagram below.

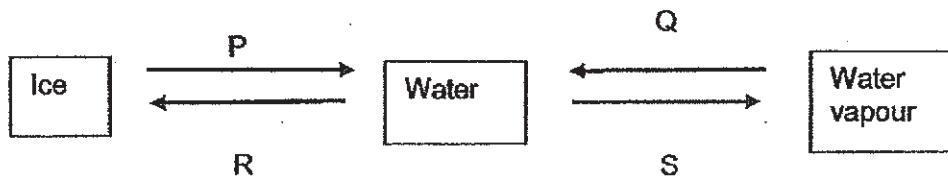

P: Melting

Q: Evaporation

R: Freezing

S: Condensation

Based on the diagram above, which of the processes are labelled correctly?

(1) P and Q

(2) P and R

(3) R and Q

(4) R and S

()

21. Esther heated some ice in a beaker and recorded the temperature changes over time.

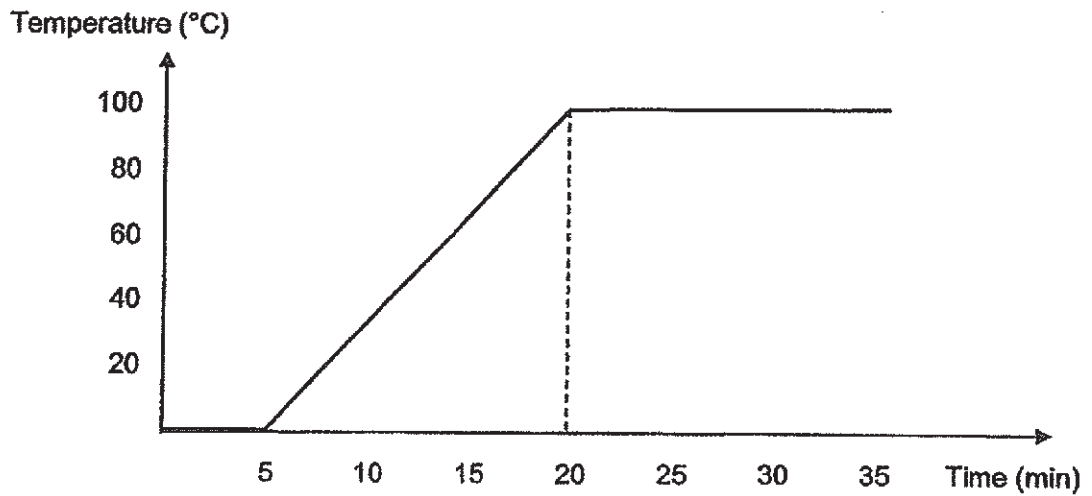

Based on the graph above, which of the statements below is correct?

- (1) The ice took 5 minutes to melt completely.
- (2) The water took 35 minutes to reach boiling point.
- (3) Esther stopped applying heat to the beaker after 30 minutes.
- (4) The water in the beaker stopped evaporating after 30 minutes. ()

22. Maria conducted an experiment as shown in the diagram below.

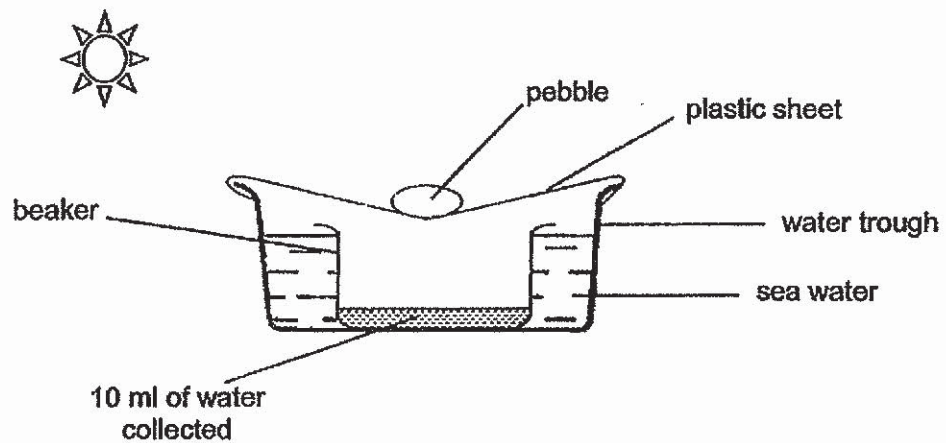

What are some of the way(s) to increase the amount of water collected in the beaker?

- A: increase the size of the pebble
- B: place the set-up in a shaded area
- C: reduce the size of the beaker
- D: reduce the size of the water trough

(1) C only

(2) A and B only

(3) B and C only

(4) C and D only

()

23. Aidan used similar bulbs, batteries and wires to set up four circuits as shown below.

In which one of the following circuits will all the bulbs shine the brightness?

(1)

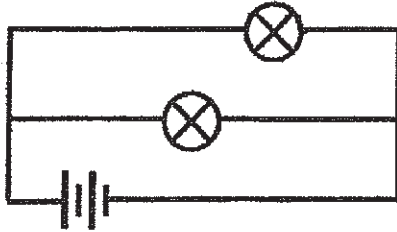

(2)

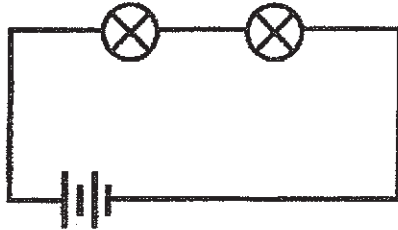

(3)

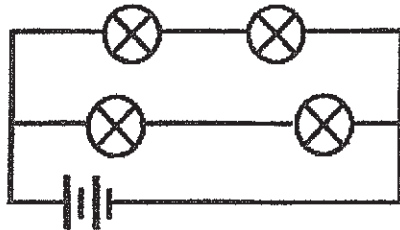

(4)

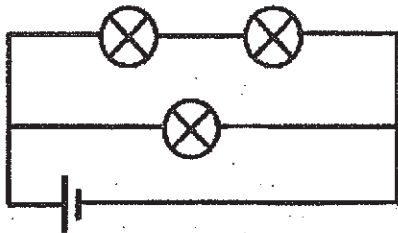

()

24. Bryan set up an electric circuit as shown below.

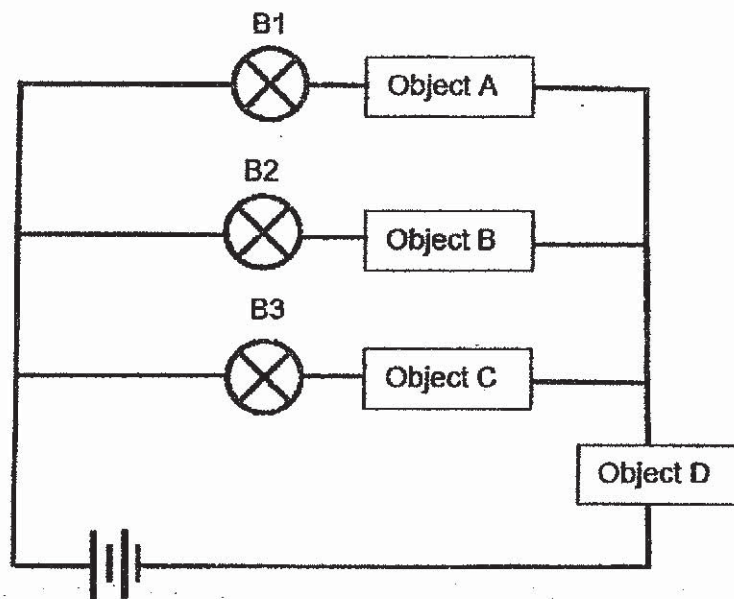

Only bulb B2 lit up.

What objects were used in the set-up above?

	Object A	Object B	Object C	Object D
(1)	metal ruler	coin	eraser	marble
(2)	marble	metal ruler	coin	eraser
(3)	eraser	coin	marble	metal ruler
(4)	coin	marble	metal ruler	eraser

25. Joel kicks a ball. The diagram shows the path of the ball after he has kicked it.

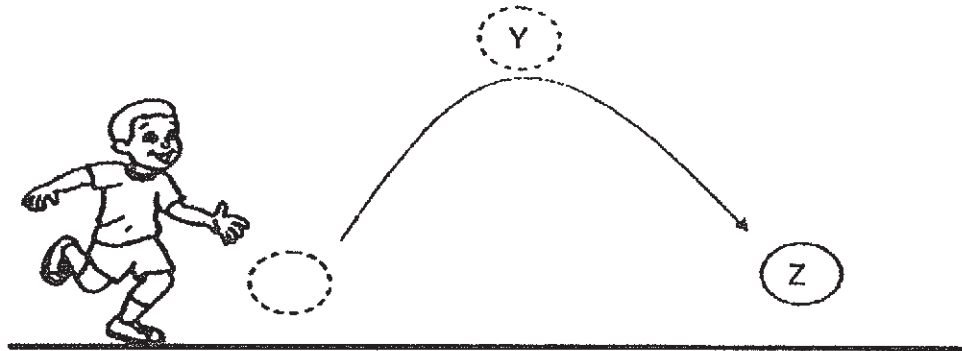

Which one of the following is correct?

	Kinetic energy of the ball from Y to Z	Potential energy of the ball from Y to Z
(1)	decreases	decreases
(2)	decreases	increases
(3)	increases	increases
(4)	increases	decreases

()

26. The diagram below shows a toy car being pushed on two similar wooden planks. The toy car moved up the plank, stopped at X and then, it rolled down.

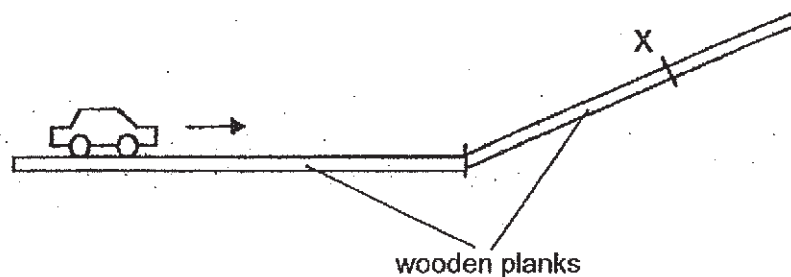

Which one of the following statements about the movement of the toy car is correct?

- (1) The toy car stopped at X because it had run out of energy.
- (2) The car stopped at X because there was no force acting on it.
- (3) The car slowed down as it moved up because the frictional force increased.
- (4) The toy car rolled down as it had gained potential energy while moving to X.

()

27. Rui En set up an experiment as shown in the diagram below. Magnets A and B are equal in mass and weigh 10g each.

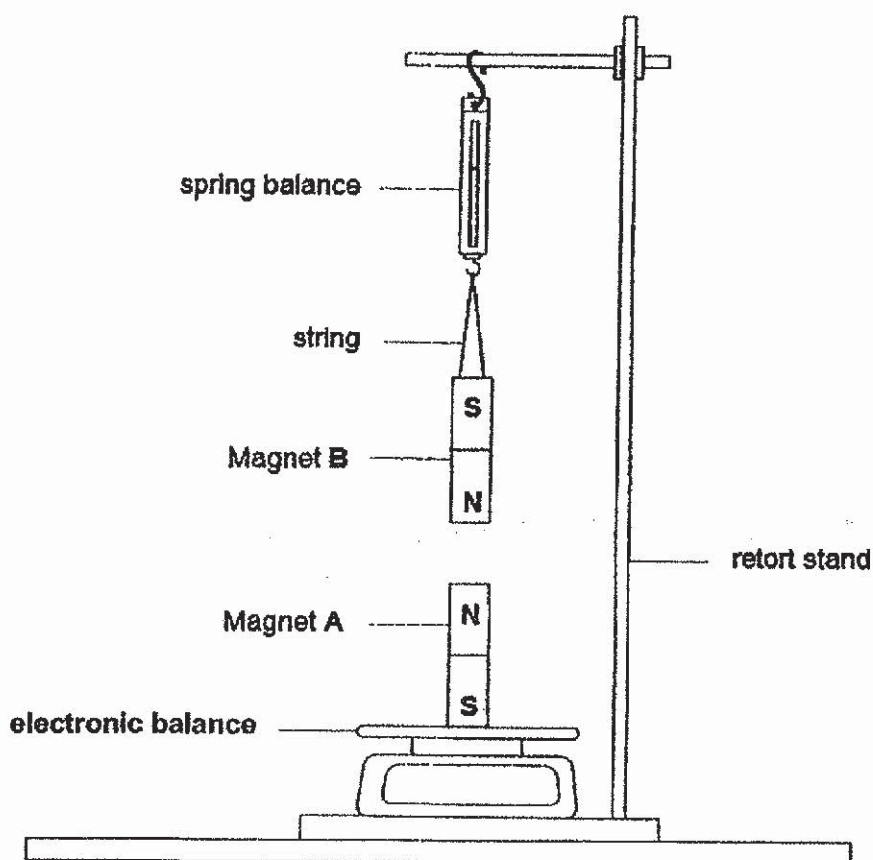

Which one of the following is correct about the set-up as shown in the diagram above?

	Position of magnet B	Reading on electronic balance (g)
(1)	moved upwards	less than 10
(2)	moved upwards	more than 10
(3)	remain at the same level	equal to 10
(4)	moved downwards	less than 10

()

28. Diagram 1 shows object X attached to a spring.

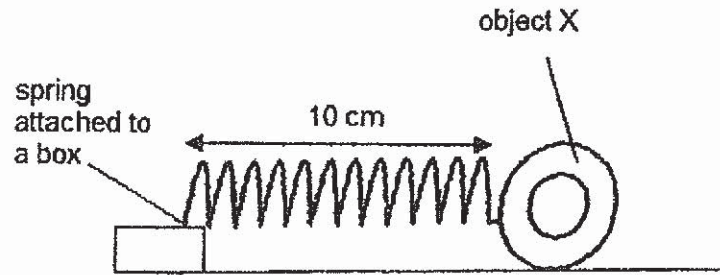

Diagram 1

Diagram 2 shows how object X moved in the direction indicated by the arrow when object Y was brought near to object X.

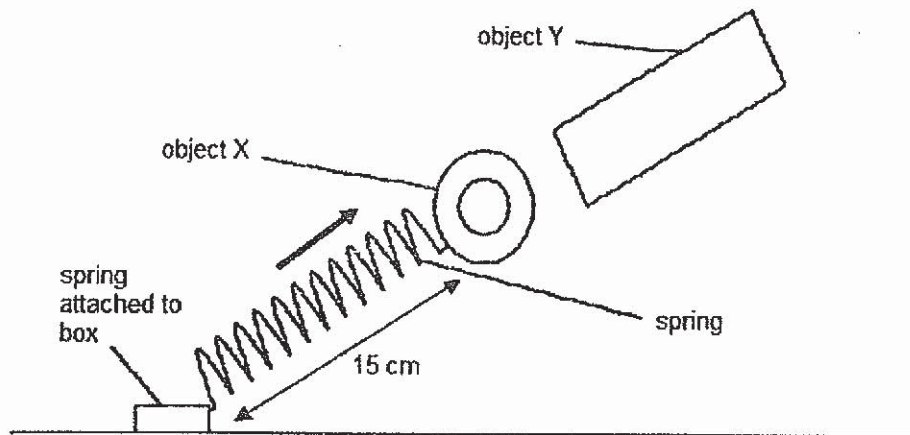

Diagram 2

Which of the following statements is correct?

- (1) Magnetic force of repulsion exists between X and Y.
- (2) Magnetic force can stop the gravitational force acting on X.
- (3) The elastic spring force increases when Y was brought near to X.
- (4) The gravitational force acting on X decreases when Y was brought near to X.

()

End of Booklet A



HENRY PARK PRIMARY SCHOOL
RELIMINARY ASSESSMENT 2019
PRIMARY 6
SCIENCE
BOOKLET B (44 MARKS)

INSTRUCTIONS TO CANDIDATES

1. Do not turn over this page until you are told to do so.
2. Follow all instructions carefully.
3. Answer all questions.

Name: _____ ()

Class: Primary 6 ()

Date: 27 August 2019

Total Time: 1 h 45 min

Marks for Booklet B: _____

Booklet B (44 marks)

For questions 29 to 40, write your answers in this booklet.

The number of marks available is shown in brackets [] at the end of each question or part question.

29. The diagram below shows a mosquito.

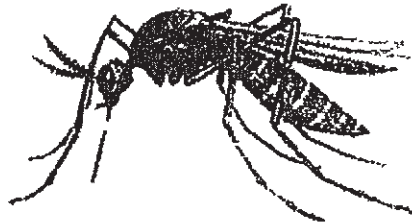

a) State a characteristic of the mosquito that makes it an insect.

[1]

A group of scientists kept some mosquitoes at different temperatures and they observed the time taken for each stage of development in its life cycle.

	Duration of stage at different temperature (days)			
	24°C	28°C	32°C	36°C
Egg	2	3	2	1
Larva	11	9	8	7
Pupa	3	3	3	2

b) How does temperature affect the number of days mosquitoes take to develop into adult stage?

[1]

c) Mosquitoes breed in stagnant water and spread the dengue virus when they are in the adult stage.

[2]

Based on the information given, explain why the number of cases of dengue fever rises during the rainy season.

30. Figures 1 and 2 show how oxygen is transported in the circulatory system of a human and fish respectively.

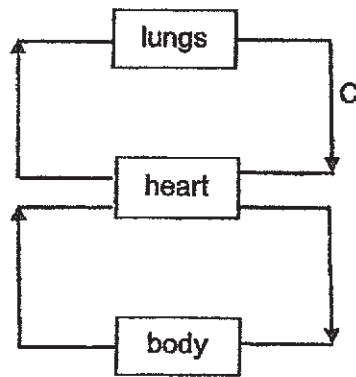

Figure 1 (human)

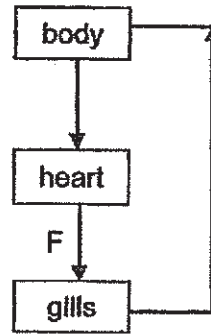
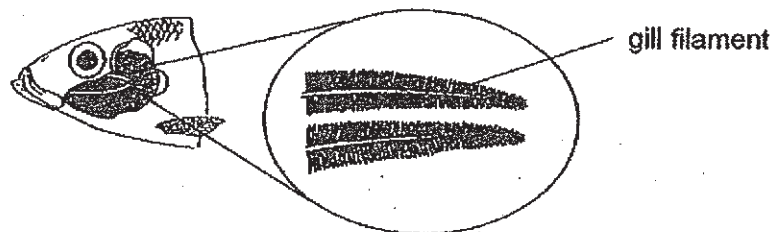

Figure 2 (fish)

- a) Based on the diagram, state how the flow of blood is similar between a human and a fish. [1]

- b) State one difference between the amount of oxygen found in the blood flowing at C and F. Give a reason for the difference. [2]



- c) The gills of a fish consist of many fine gill filaments. [1]

How does this structural adaptation help the fish take in more dissolved oxygen from the water?

31. Graph 1 shows the amount of carbon dioxide emissions in a certain area.

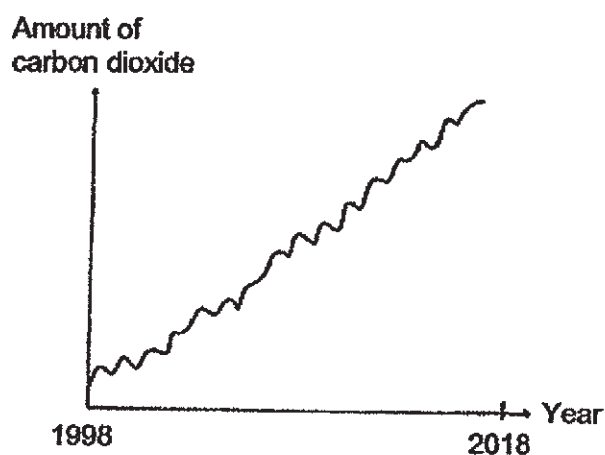

Graph 1

a) What is the trend in the amount of carbon dioxide as observed in Graph 1?

[1]

Study Graph 2 shown below.

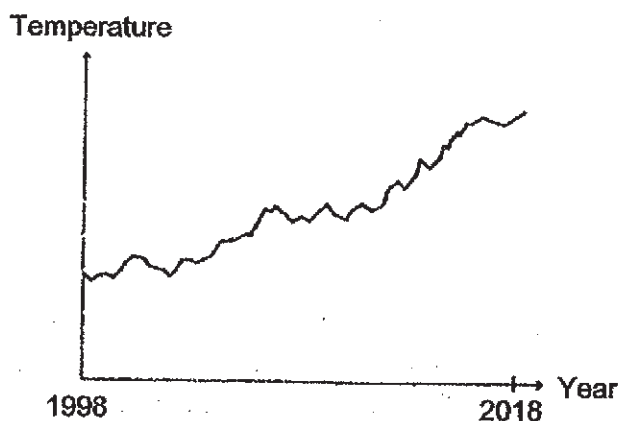

Graph 2

b) Based on Graphs 1 and 2, what is the relationship between carbon dioxide levels and temperature in the environment?

[1]

c) As global temperatures rises, the ice in the Antarctic melts.

Explain how this may affect small islands around the world in future.

[1]

32. Study the diagram of a flower below.

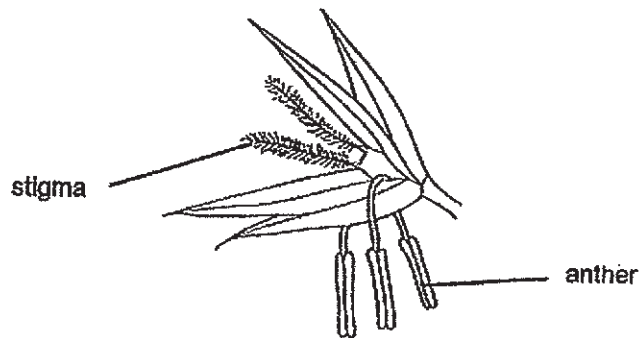

a) Describe the process of pollination.

[1]

b) Is the flower pollinated by wind or animal? Explain your answer.

[1]

c) After pollination, the flower develops into a fruit.

[1]

Explain why it is important for the seeds of the fruits to be dispersed far away from the parent plant.

33. Jun Hong carried out an experiment with a plant as shown in diagram 1. Two parts of the stem, X and Y, were removed as shown in diagram 2.

Before the start of the experiment, the plant was kept in the dark to remove all the starch. The plant was then exposed to sunlight for at least 12 hours.

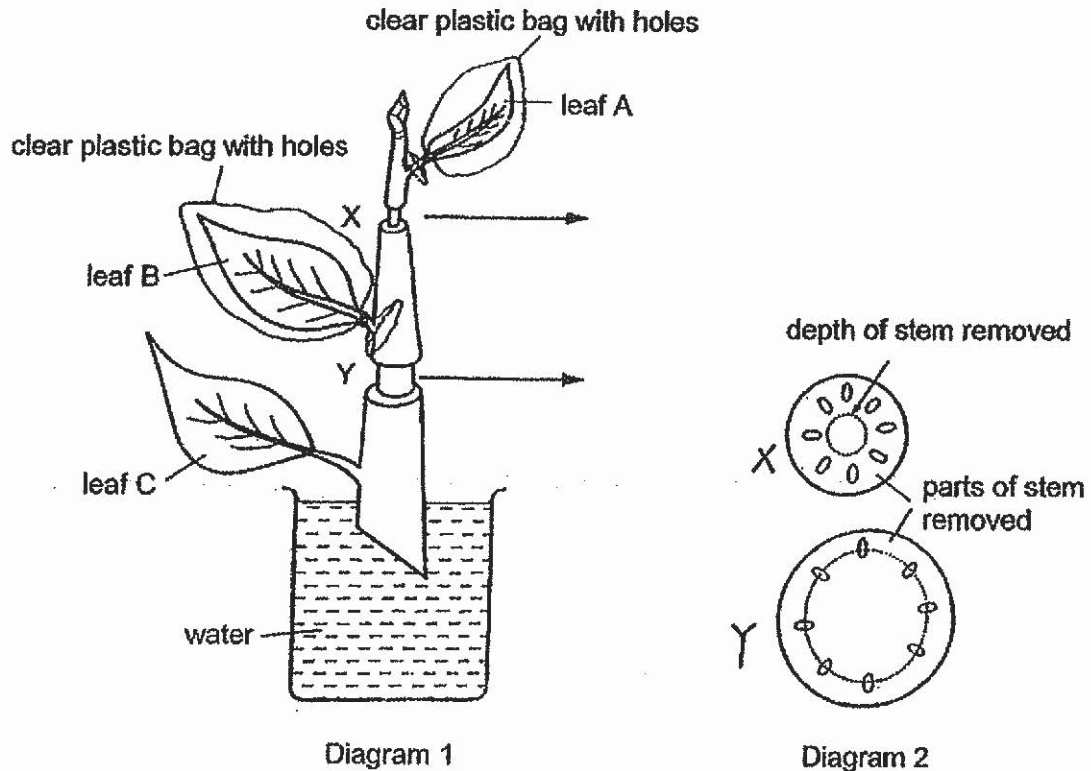

- a) A substance which is necessary for photosynthesis is absent in leaf A. [1]

State the substance.

- b) Give a reason why the plant was exposed to sunlight for at least 12 hours. [1]

- c) Besides repeating the experiment, suggest another way Jun Hong could make the results of the experiment more reliable. [1]

34. Aurelia classified some organisms, A, B, C and D, which she observed in a lime tree and drew a classification chart as shown below.

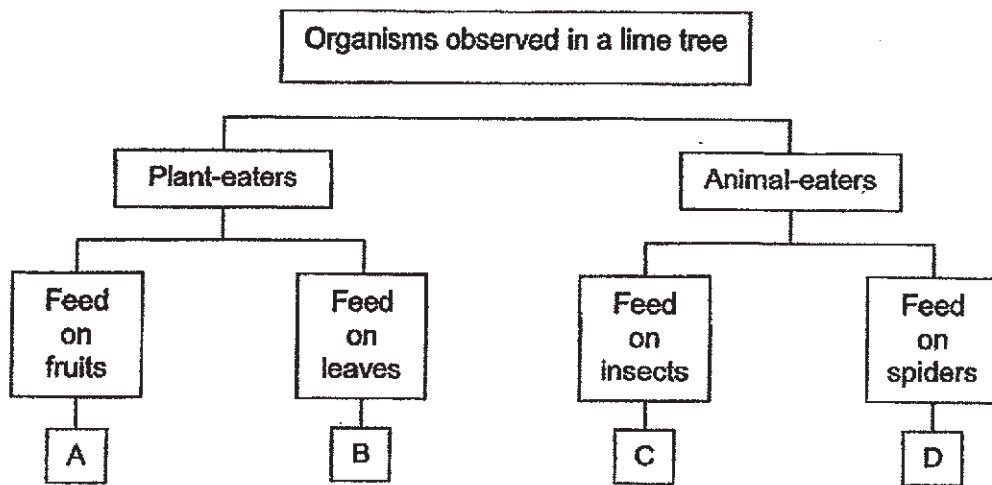

- a) Based on the classification table, fill in the letters, A, B, C and D, which represent the organisms in a likely food web of the lime tree community below.

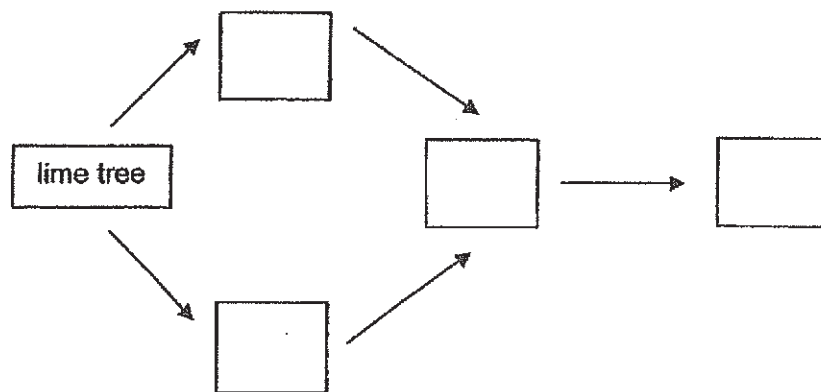

- b) Which one of the organisms, A, B, C or D, would likely be affected directly if the flowers of the lime tree are not pollinated? Give a reason for your answer. [1]

- c) If the population of organism D decreases over time, what is the most immediate effect likely to be observed in the lime tree community? Give a reason for your answer. [1]

Question 34 continued

Aurelia also discovered another organism E on the bark of the trunk of the lime tree.

The diagrams below show part of the lime tree trunk and the enlarged diagram of organism E.

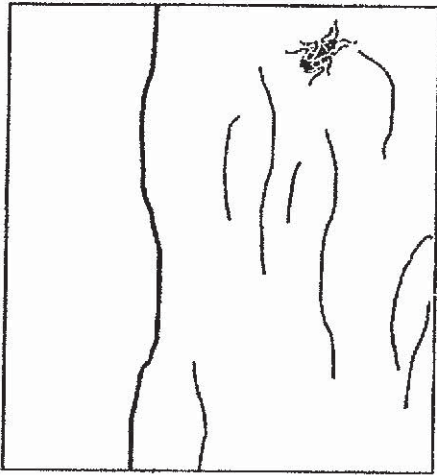

Part of the lime tree trunk

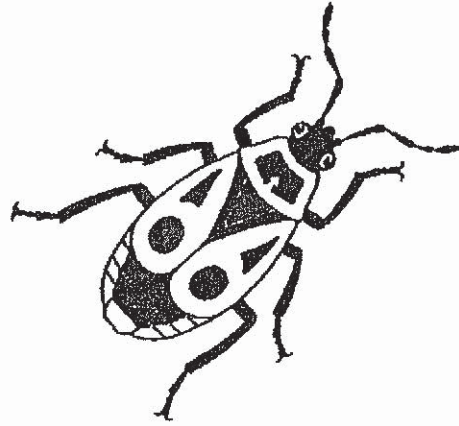

Enlarged diagram of organism E

- d) Based on the diagrams given, explain how organism E is able to avoid being eaten by its predators. [1]

35. Isaac was ordering hot tea from the drinks stall when he noticed that the drink stall assistant poured boiling water into the cup first and waited for a few seconds.

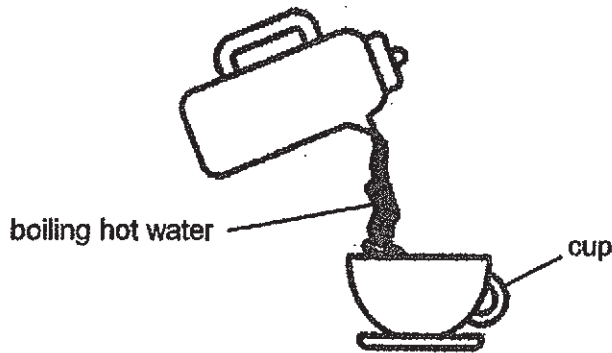

The drinks stall assistant then poured away the boiling-hot water in the cup and replaced it immediately with the hot tea as shown in the diagram below.

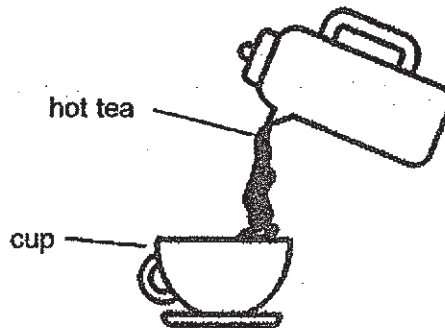

- a) How does this method make the tea hotter than if it was poured into the cup directly? [2]

The diagram below shows a double-walled plastic cup with air space.

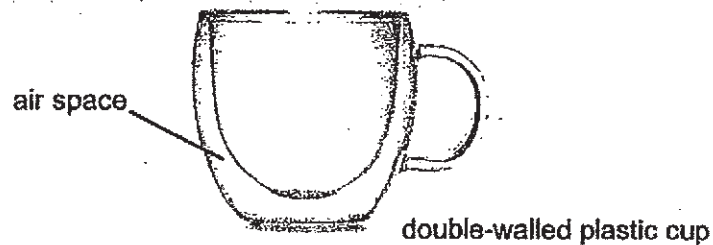

- b) How does this cup help to keep the hot drinks warm for a longer period of time? [1]

Question 35 continued

- c) Isaac poured some iced water in the double-walled plastic cup.

[2]

Will there be many water droplets formed due to condensation on the outside of the cup?
Explain your answer.

The set-up below uses a light sensor to detect the amount of light coming from the light source.

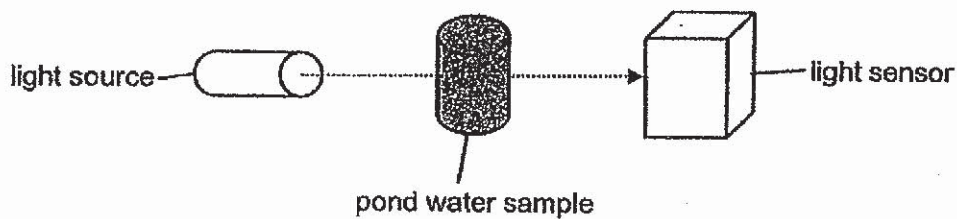

Ali collected water samples from three ponds, X, Y and Z. The water samples are then placed one at a time between the light source and light sensor. He recorded the amount of light captured by the light sensor in the table below.

Water Sample	Pond X	Pond Y	Pond Z
Amount of light captured (unit)	91	15	206

- a) Based on Ali's results, at which pond, X, Y or Z, are you most likely to find water plants growing at the bottom of the pond? Give a reason for your answer.

[2]

- b) Predict how the population of fishes will change when the number of water plants growing at the bottom of the pond increases.

Give a reason for your answer.

[2]

37. In the diagram below, Zac put his wet hands under a hand-dryer, which is fixed to the wall.

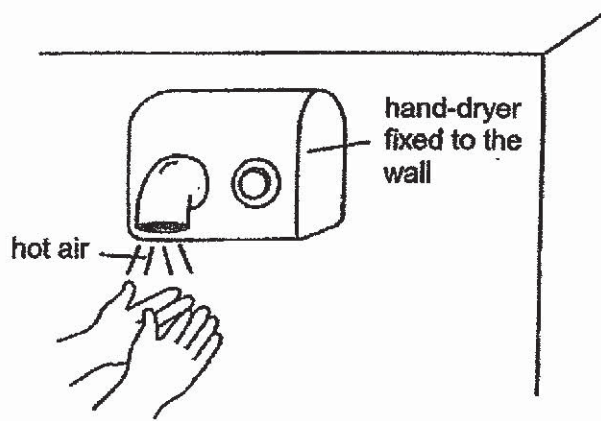

a) A process causes Zac's wet hands to be dry after some time.

State and describe how this process help Zac to dry his hands.

[1]

b) Zac observed that he could dry his hands more quickly when he rubbed his wet hands under the hand dryer.

Explain why this is so.

[2]

38. Gene has a toy aeroplane that works on batteries.

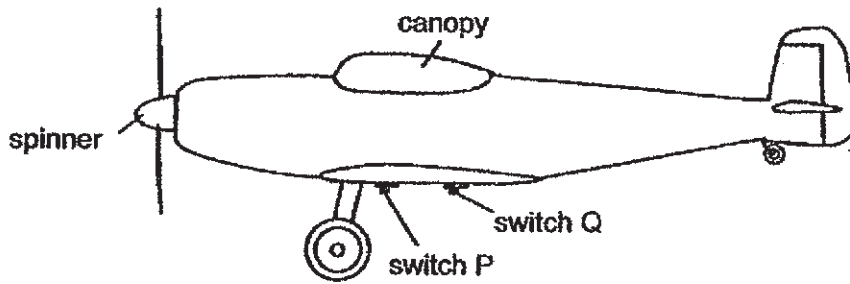

He plays with the toy aeroplane and makes the following observation.

Switched ON	Number of batteries used	Observation
P only	1	Spinner turned. Canopy did not light up.
Q only	2	Spinner did not turn. Canopy lit up.
Both P and Q	3	Both spinner and canopy light turned on.

a) The diagram below shows the circuit of the toy aeroplane.

Based on Gene's observation, complete the circuit so that it will work.

[2]

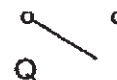
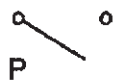
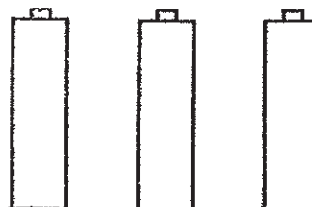

Question 38 continued

- b) Of the three batteries, one of them is faulty. Gene would like to continue playing with the toy aeroplane.

He found the following items in the kitchen drawer.

- a wooden ruler
- a plastic sheet
- a roll of aluminium foil

Using the remaining batteries and one of the given items, describe how Gene could continue to play with the toy aeroplane with both the spinner and canopy turn on.

[2]

39. The diagram below shows the front and side views of wind turbine X.

AB is the diameter of the wind turbine.

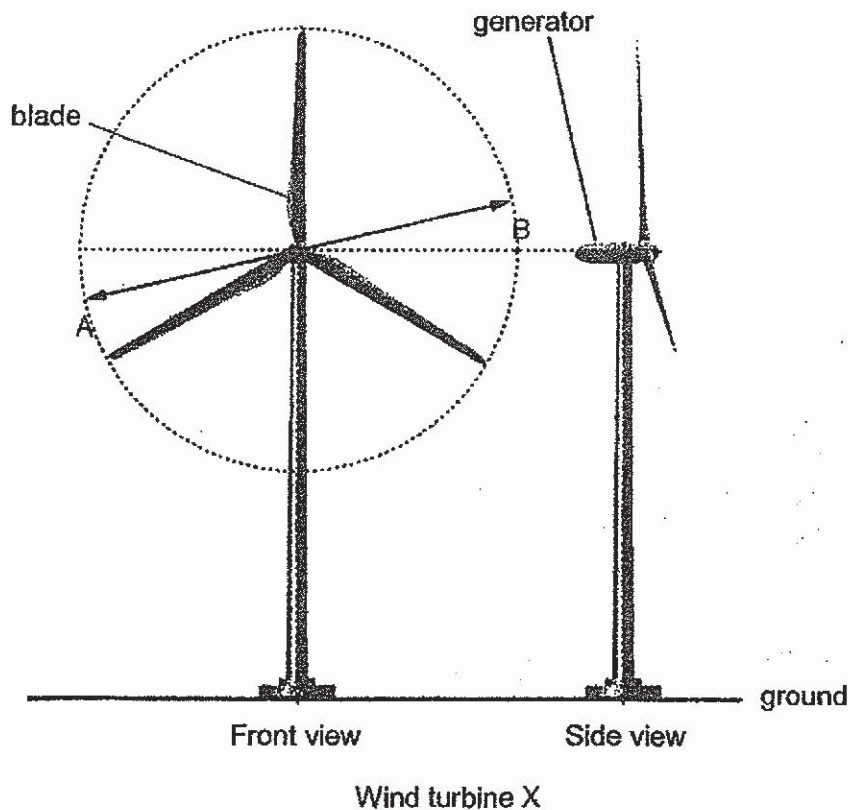

- a) State how using wind turbines help us to protect our environment.

[1]

Question 39 continued

b) Fill in the boxes to show the energy changes in a wind turbine.

[1]

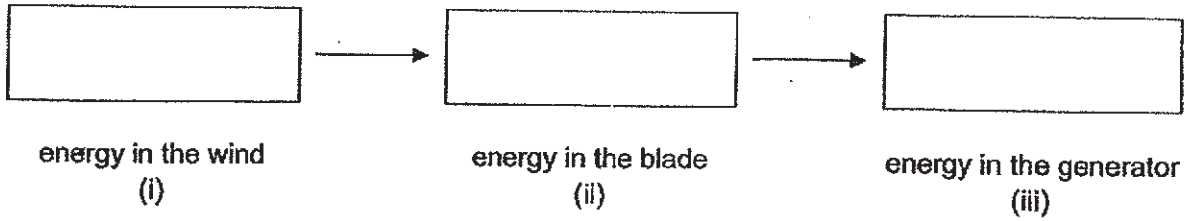

The diagram below shows another type of wind turbine Y of the same diameter as AB and made of the same material as wind turbine X.

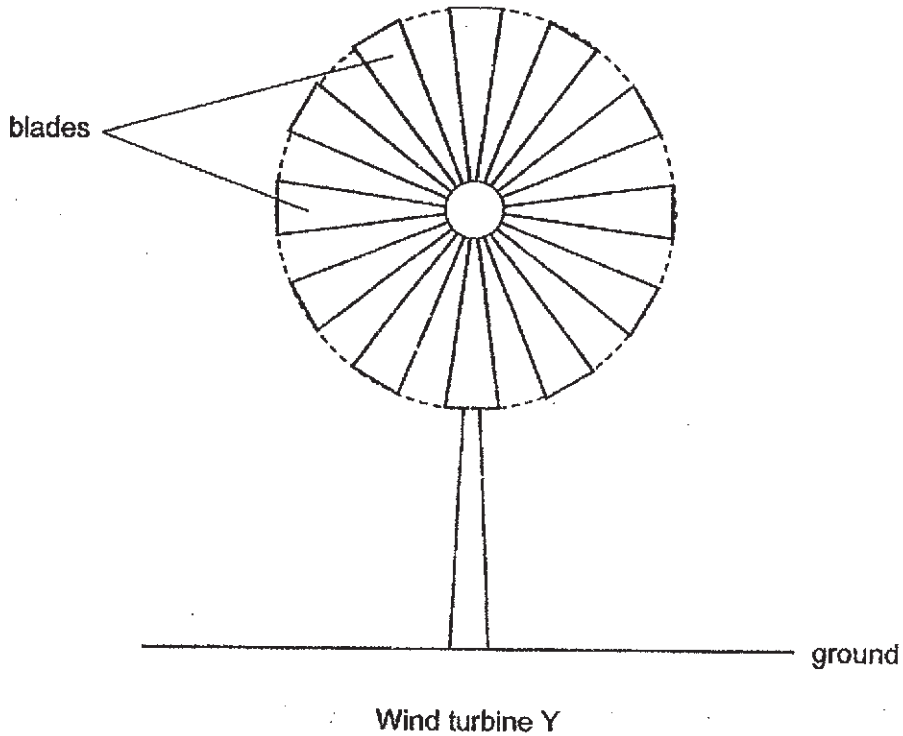

Wind turbine Y is also found at the same location as wind turbine X.

c) The amount of electricity produced by wind turbine Y is less than wind turbine X.

Explain why this is so.

[2]

40. Ayush carried out an experiment with three toy guns, X, Y and Z, each with a different length of the gun barrel.

The experiment was carried out in an enclosed area without wind. For each try, he measured the distance travelled by the pellet.

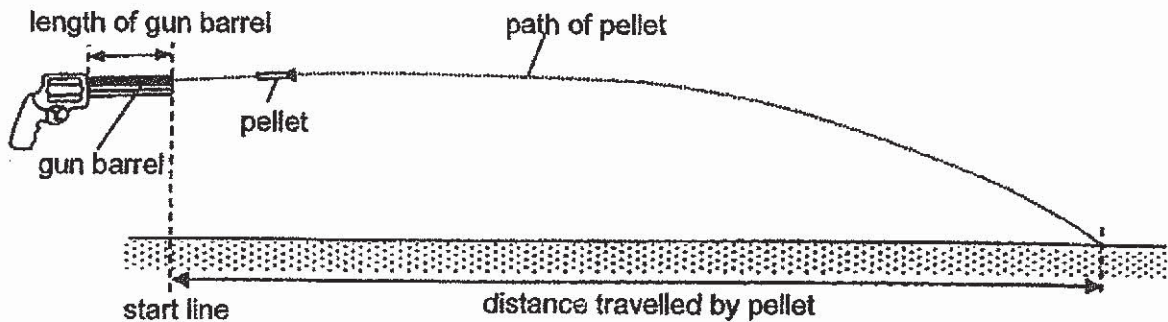

Toy gun	Gun barrel length (cm)	Distance travelled by the pellet (cm)		
		1 st try	2 nd try	3 rd try
X	10	141	147	143
Y	12	166	170	168
Z	14	182	186	179

- a) For each of the tries of the same gun barrel length, the distance travelled by the pellet is different.

Give two possible reasons for this.

[2]

Reason 1: _____

Reason 2: _____

- b) How is the distance travelled by the pellet affected by the length of the gun barrel of the toy gun? [1]

End of Booklet B

Setters: Mr Tan Joo Nam and Mr Matthew Teo Puay Liang

SCHOOL : HENRY PARK PRIMARY SCHOOL
LEVEL : PRIMARY 6
SUBJECT : SCIENCE
TERM : 2019 PRELIM

SECTION A

Q 1	Q2	Q3	Q4	Q5	Q6	Q7	Q8	Q9	Q10
2	1	3	2	1	3	2	4	1	3
Q 11	Q12	Q13	Q14	Q15	Q16	Q17	Q18	Q19	Q20
3	2	3	4	3	4	2	3	2	2
Q 21	Q22	Q23	Q24	Q25	Q26	Q27	Q28		
1	1	1	3	4	4	2	3		

2019 P6 Prelims Science
Correction Sheet

Name: _____ () Class: _____

Booklet B

Question	Suggested answer
29a	It has six legs / three body parts.
29b	The higher the temperature, the shorter the number of days mosquitoes take to develop into adult stage
29c	There will be <u>more</u> places with <u>stagnant</u> water, so <u>more</u> eggs will be laid and develop into the adult stage.
30a	The blood for both human and fish flows to the heart before going to the respiratory organ / lungs or gills for gaseous exchange.
30b	There is more oxygen at C than at F. The blood at C had just obtained oxygen from the lungs while the blood at F is being pumped by the heart to obtain oxygen from the gills.
30c	The filaments increase the surface area for (faster) gaseous exchange.
31a	The amount of carbon dioxide is increasing.
31b	As the amount of carbon dioxide increases, the temperature in the environment increases.
31c	Sea levels will rise and small islands could be submerged due to more floods.
32a	Pollination. It is the transfer of pollen grains from the <u>anther</u> to the <u>stigma</u> of a flower.
32b	Wind pollinated flower. The anthers are sticking outside from the petals and the stigma is large / feathery.
32c	The seeds are dispersed far away to prevent overcrowding and reduce competition for water, nutrients, space and sunlight.
33a	Water
33b	carry out photosynthesis.
33c	He should conduct the experiment on more plants / leaves of the same plant.
34a	<pre> graph LR Anther --> A1B Anther --> B1A A1B --> C B1A --> C C --> D </pre>

2019 P6 Prelims Science
Correction Sheet

34b	Organism A. Fertilisation cannot take place and fruits cannot be formed.
34c	The population of organism C will increase as there are fewer predators to feed on them.
34d	The 'patterns' on the back of organism E scare away its predators.
35a	The cup gains heat from the boiling water and becomes warm. The hot tea will lose less heat to the cup / gain heat from the cup.
35b	Air is a poor conductor of heat and the hot drinks lose heat to the surroundings at a slower rate / the hot drinks lose less heat to the surroundings.
35c	No. The outer surface of the cup will lose less heat to the iced water, thus the outer surface will not be as cold. Water vapour in the surrounding air will condense more slowly on the outer surface.
36a	Pond Z. The amount of light captured is the highest, thus more water plants can photosynthesise.
36b	Population of fishes will increase. The plants provided the fishes with more food / more oxygen / more shelter from predators.
37a	Evaporation. Water on his hands gains heat from the hot air and evaporates / becomes water vapour.
37b	Rubbing of wet hands produce more heat, causing the water to evaporate more quickly.
38a	

2019 P6 Prelims Science
Correction Sheet

38b	Replace the faulty battery lighting up the canopy with the aluminium foil.
39a	It reduces the release of pollutants into the air.
39b	(i) kinetic, (ii) kinetic, (iii) electrical
39c	Turbine Y has more mass hence it needs more kinetic energy in the wind to spin the blades.
40a	Each time, he shot the pellet at different heights from the ground. Each time, he shot the pellet at different angles from the ground.
40b	As the length of the barrel of the toy gun increases, the distance travelled by the pellet increases.

