

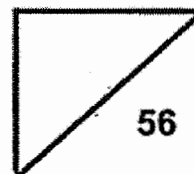

Rosyth School
Preliminary Examination 2020
SCIENCE
Primary 6

Total
Marks:



Name: _____

Class: Pr 6- _____ Register No. _____

Total time for
Booklets A and B: 1 h 45 min

Date: 27 August 2020

Booklet A

Instructions to Pupils:

1. Do not open the booklet until you are told to do so.
2. Follow all instructions carefully.
3. This paper consists of 2 booklets, Booklet A and Booklet B.
4. For questions 1 to 28 in Booklet A, shade the correct ovals on the Optical Answer Sheet (OAS) provided using a 2B pencil.

* This booklet consists of 23 printed pages (including cover page).

For each question from 1 to 28, four options are given. One of them is the correct answer. Make your choice (1, 2, 3 or 4) and shade your answer on the Optical Answer Sheet.

[56 Marks]

1 All plants _____

- (1) make their own food
- (2) reproduce by seeds
- (3) bear flowers and fruits
- (4) need oxygen at night only

2 Many years ago, a scientist discovered an animal P and studied its characteristics.

Some of the characteristics of animal P are as follows:

- A lays egg
- B has four legs
- C can swim in water
- D can produce milk to feed the young

Which of the above characteristics made it difficult to classify animal P as a mammal?

- (1) A only
- (2) D only
- (3) A and C only
- (4) B and D only

3 Study the four set-ups as shown below. All set-ups were placed near a window on a sunny day.

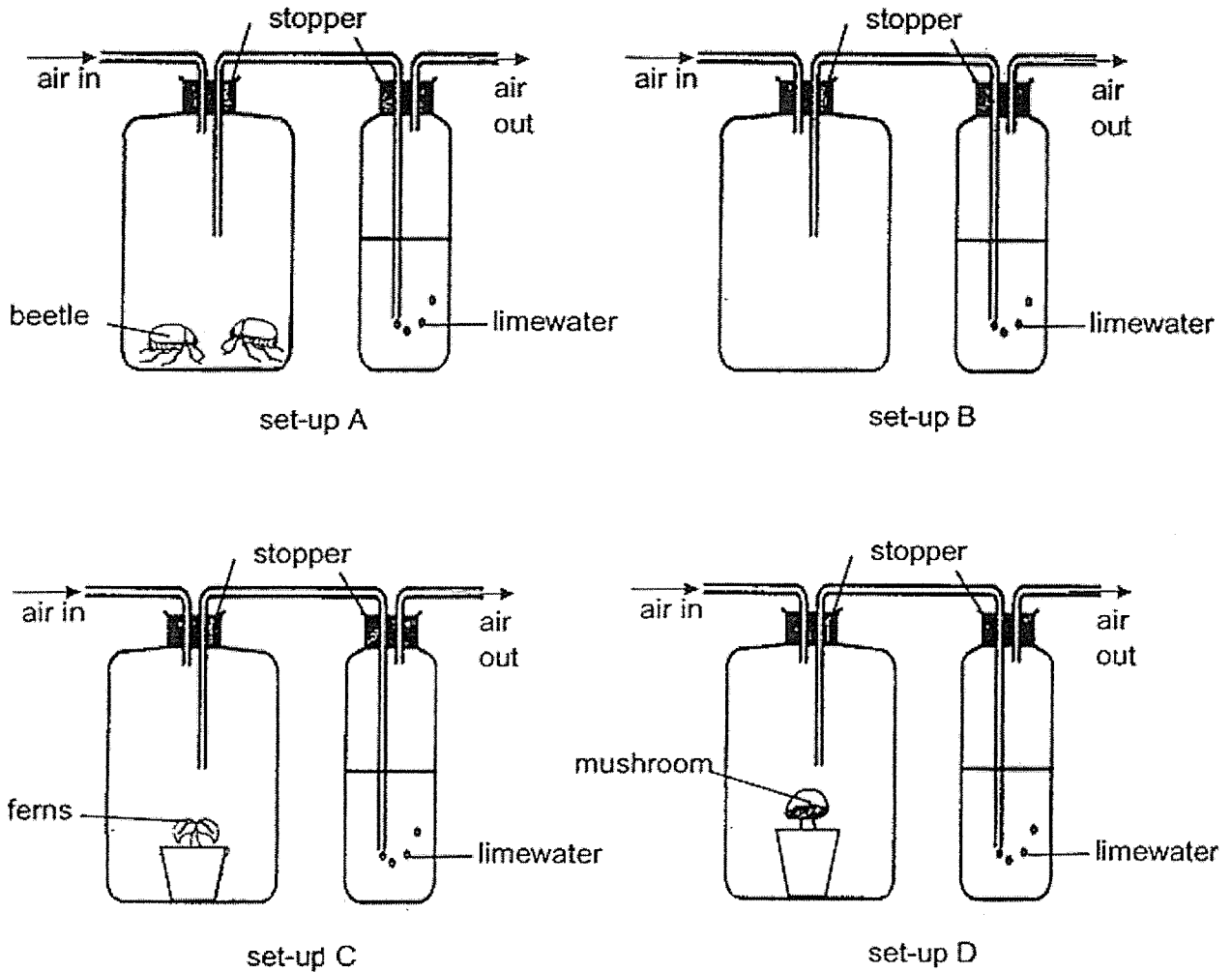

Limewater changes from colourless to chalky in the presence of carbon dioxide. In which set-up will the limewater turn chalky the slowest?

- (1) A
- (2) B
- (3) C
- (4) D

- 4 Some scientists claim that plants will glow in the dark when modified.
Which part of the plant cell has been modified for the investigation?

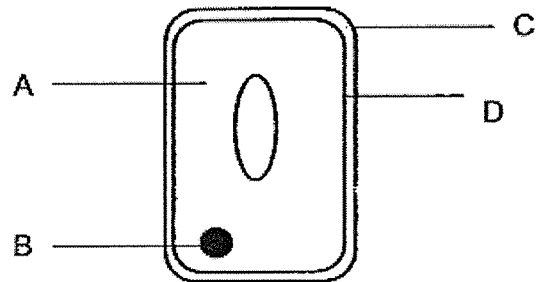

- (1) A
(2) B
(3) C
(4) D
- 5 Which one of the substances is not transported by the human circulatory system?
- (1) water
(2) digested food
(3) carbon dioxide
(4) undigested food

- 6 The two graphs below show Mary's breathing before exercise and during exercise respectively.

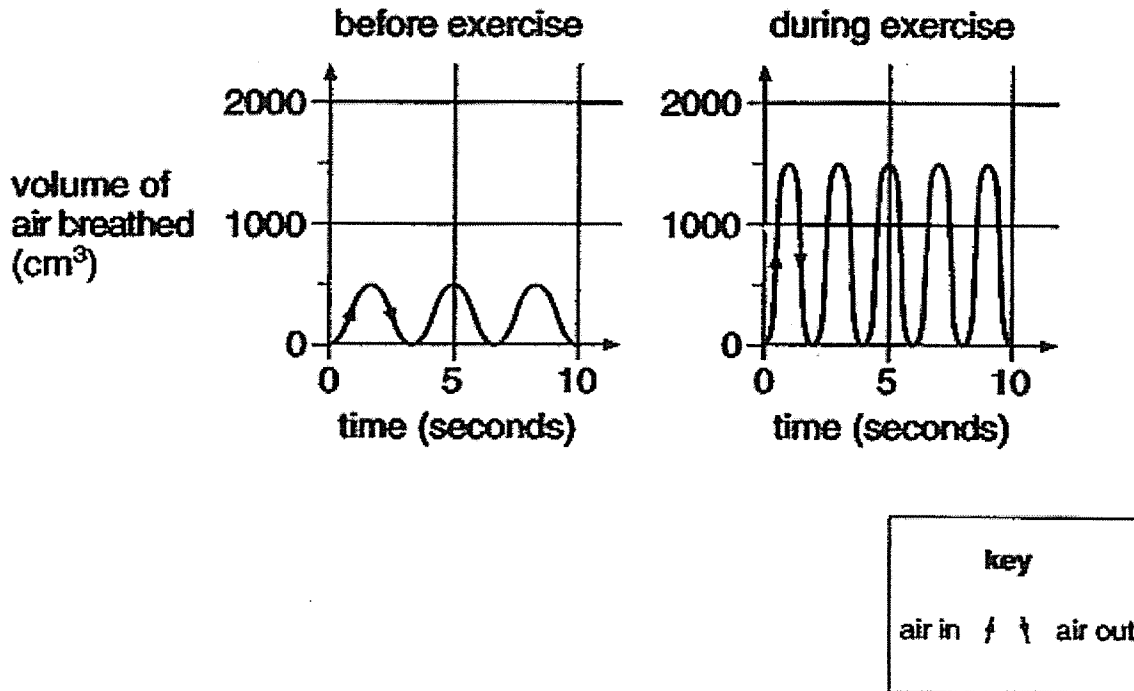

In which ways will Mary's breathing change during exercise?

- A Time taken for one breath
 - B Volume of oxygen breathed in
 - C Volume of nitrogen breathed out
 - D Volume of carbon dioxide breathed out
- (1) A and B only
 (2) C and D only
 (3) A, B and D only
 (4) A, B, C and D

- 7 The diagram shows part of the stem of a small tree with a ring of bark removed. Removing the ring of bark takes away the food-carrying tube but not the water-carrying tube.

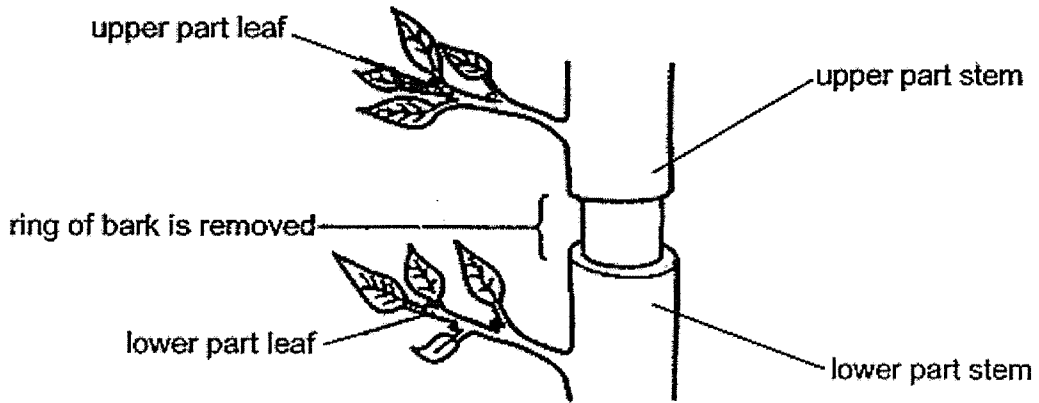

The effect of removing the ring of bark was observed after some time.

What would be the effect ?

	Upper part		Lower part	
	stem	leaf	stem	leaf
(1)	normal	green	normal	green
(2)	swollen	wilt	swollen	wilt
(3)	swollen	green	normal	wilt
(4)	swollen	green	normal	green

- 8 A group of boys wanted to carry out an experiment to find out if mopping the floor will increase their pulse rate.

The steps of their experiment are as follows:

- A Take a wet mop
- B Mop the floor continuously for 10 minutes
- C Stop mopping and measure the pulse rate immediately

Their teacher said that they have forgotten an important step and without that step, they cannot make a conclusion.

Which step should they include in their experiment so that they can make a conclusion?

- (1) Repeat the experiment
 - (2) Record the results in a table
 - (3) Measure the pulse rate at rest
 - (4) Measure the heart rate after mopping
- 9 The diagram below shows the human reproductive systems.

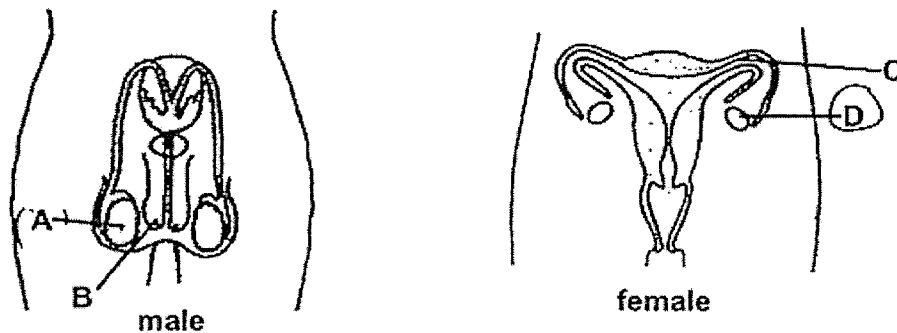

Where are the human reproductive cells produced?

- (1) A and C
- (2) B and D
- (3) A and D
- (4) B and C

10 The diagram shows a cross-section of a flower.

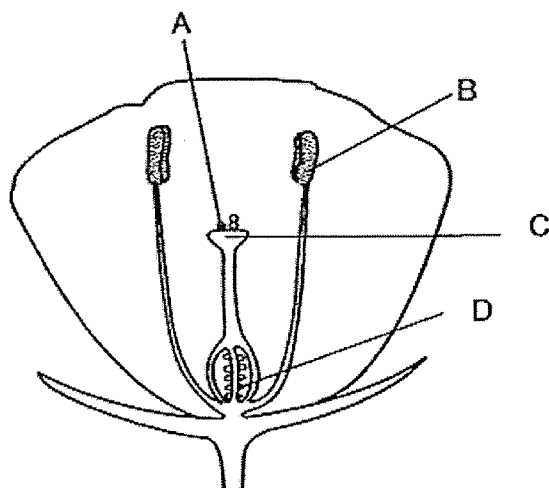

Which one of the following statements is correct?

- (1) Fertilisation occurs at D.
- (2) A will become a seed after fertilisation.
- (3) Pollen grains are transferred by insects to B.
- (4) The reproductive cells are found in B and C

11 Which graph correctly shows the relationship between the mass of seed leaves and the height of the seedling?

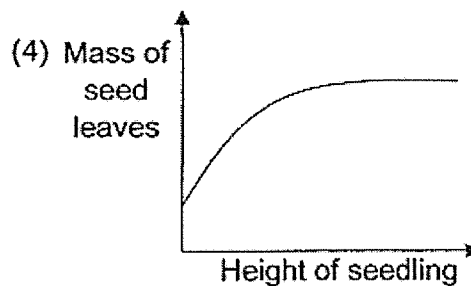
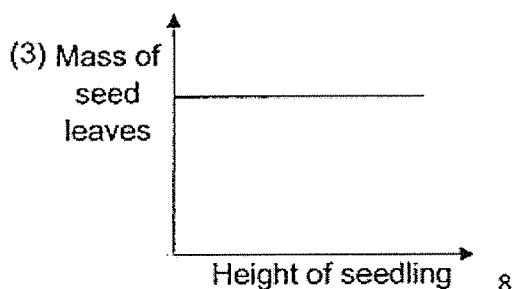
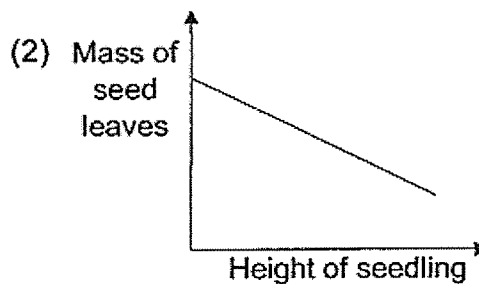
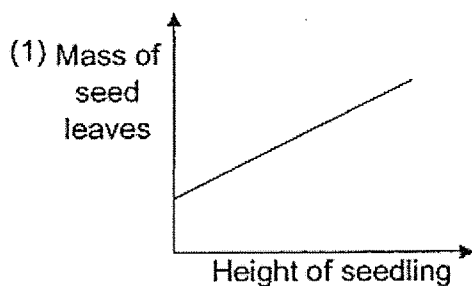

12 The diagrams below show some fruits on a tree and a baby inside a mother's womb.

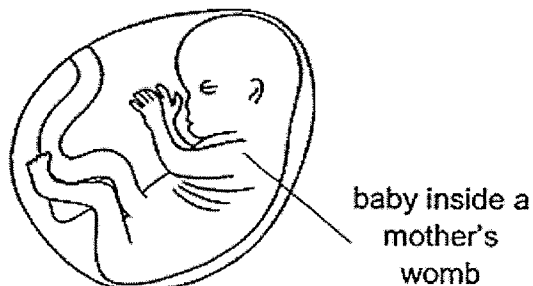
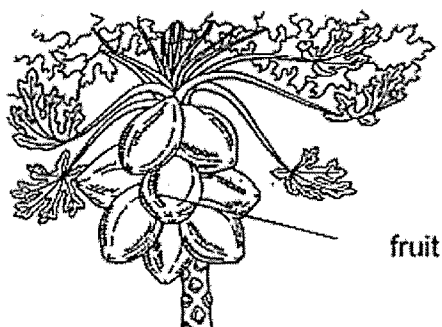

Alex made three statements about the fruit and the baby.

- A It develops into an adult.
- B It developed after fertilisation.
- C It obtains food from its parent for growth.

Which of the following is correct?

	fruit	baby inside a mother's womb
(1)	A,B,C	A,B, C
(2)	A, B	A,B,C
(3)	B,C	A, B,C
(4)	B,C	A, C

13 Ravi compared the life cycles of two animals and made the following statements.

- Both their young resemble the adult.
- Both animals have 3 stages in their life cycles.

Which animals was Ravi comparing?

- (1) Chicken and beetle
- (2) Butterfly and chicken
- (3) Grasshopper and beetle
- (4) Chicken and grasshopper

- 14 Siti carried out an experiment on germination of seeds using two different types of seeds placed in identical containers A and B as shown below.

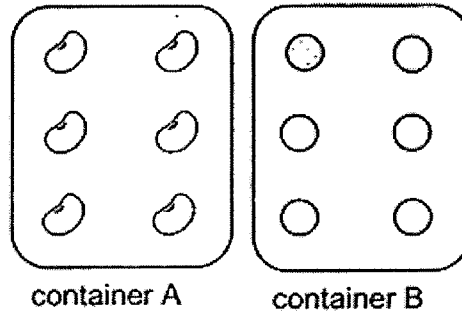

She predicted that the seeds will germinate faster with 50 ml of water. However, her friend predicted that adding only 10 ml of water will help the seeds to germinate faster.

Which of the following set-ups should Siti use to provide a correct test for both their predictions?

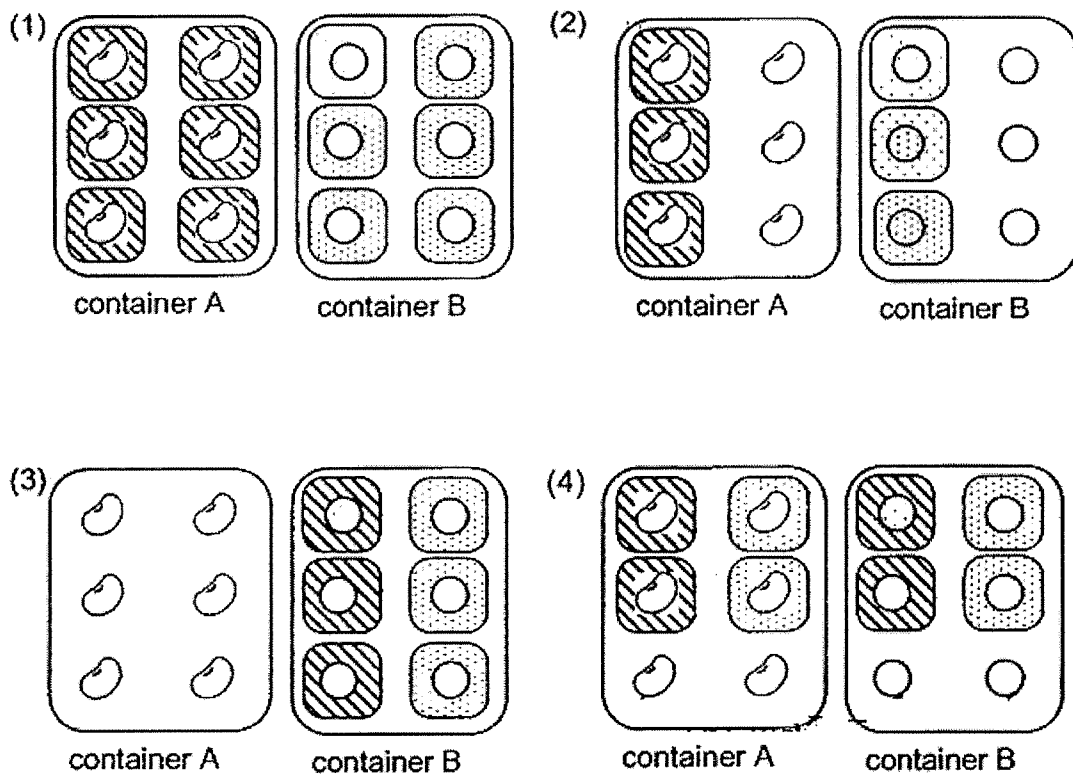
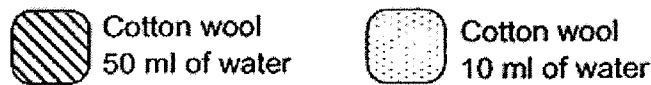

15 The diagram below shows Substance X in a container at various temperatures.

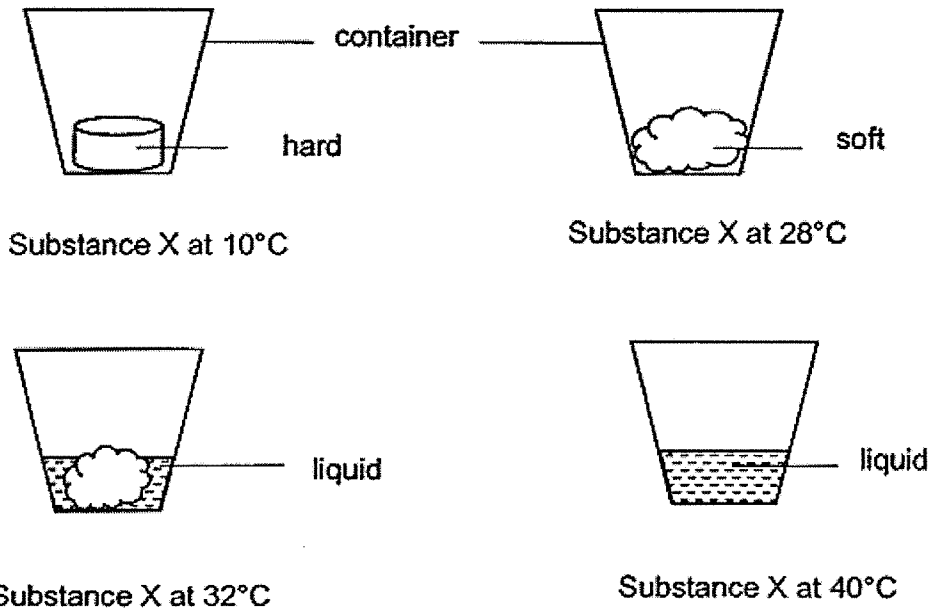

Based on the above information, which one of the following is the melting point of Substance X?

- (1) 10°C
- (2) 28°C
- (3) 32°C
- (4) 40°C

16 The diagram shows what a person can do.

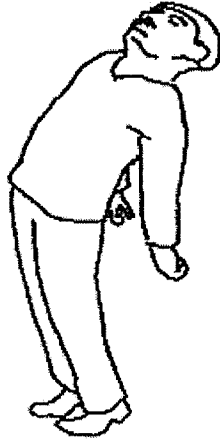

This shows the property of _____.

- (1) strength
- (2) elasticity
- (3) flexibility
- (4) waterproof

- 17 Mrs Tan realises that there is fogging on her spectacles when she wears her mask as shown.

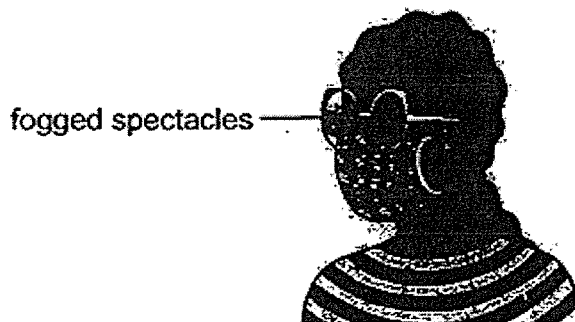

Which of the following correctly shows where the fogging takes place and where the warmer water vapour comes from?

	Fogging takes place on the _____ surface of spectacles	Warmer water vapour comes from _____
(1)	inner	Mrs Tan's breath
(2)	outer	Mrs Tan's breath
(3)	inner	the surrounding air
(4)	outer	the surrounding air

- 18 Diagram 1 shows the mass of magnet M when it is placed on an electronic balance. Diagram 2 shows its mass when another object Y is placed above it.

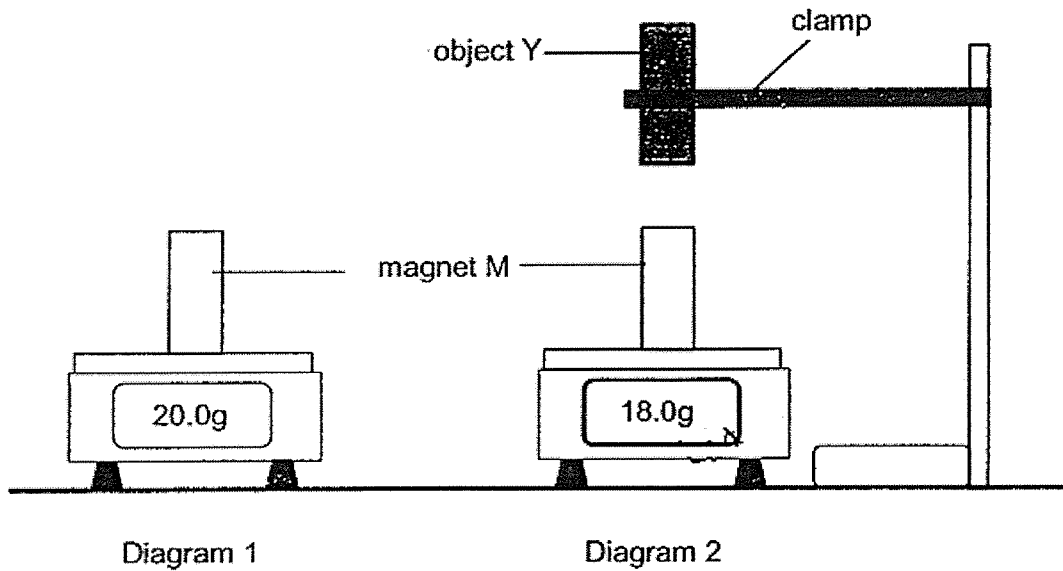

Which of the following shows the material of object Y and the direction of the magnetic force acting on object Y?

	Material of object Y	Magnetic force acting on Y
(1)	copper	↑
(2)	copper	↓
(3)	steel	↓
(4)	steel	↑

- 19 Three children were making shadow animals with their hands. They placed their hands which were of the same size at positions X, Y and Z between a light source and a wall as shown below.

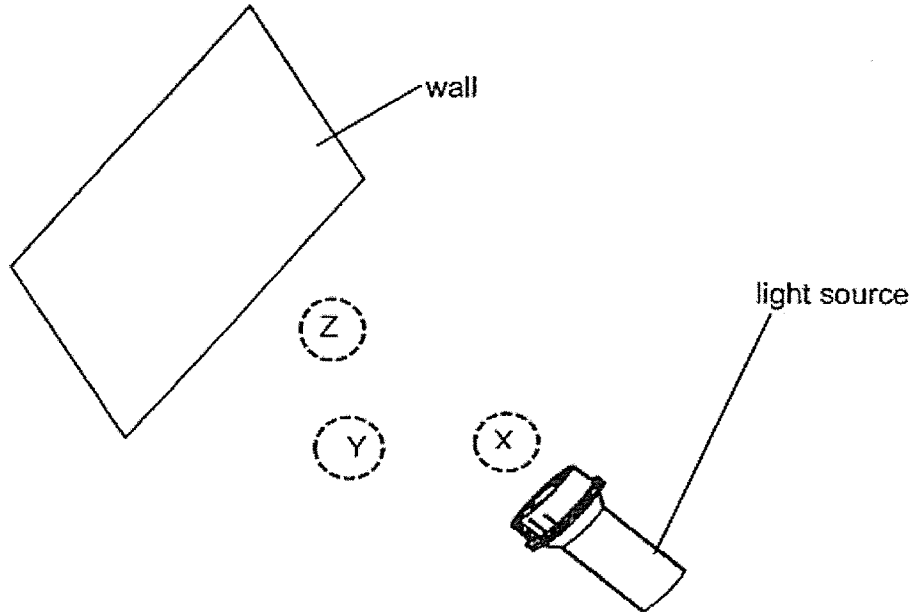

The size of each shadow animal was seen on the wall as shown below.

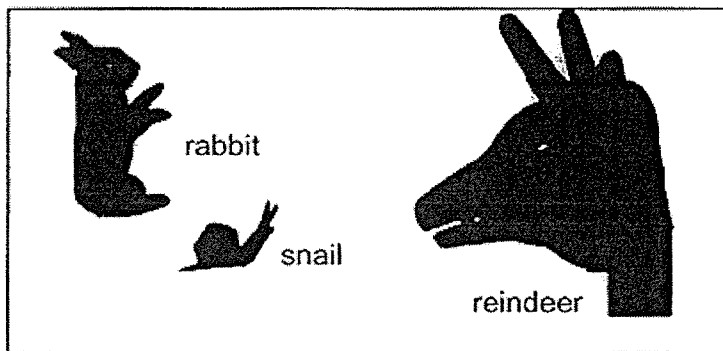

Which of the following shows the positions of the children's hands, X, Y and Z?

	Shadow animal		
	reindeer	rabbit	snail
(1)	X	Y	Z
(2)	X	Z	Y
(3)	Z	Y	X
(4)	Z	X	Y

- 20 Dan released a tennis ball and a basketball each from the same height above the ground. The balls hit on the ground and bounced a few times before stopping. He measured the height of the first rebound for each ball as shown below.

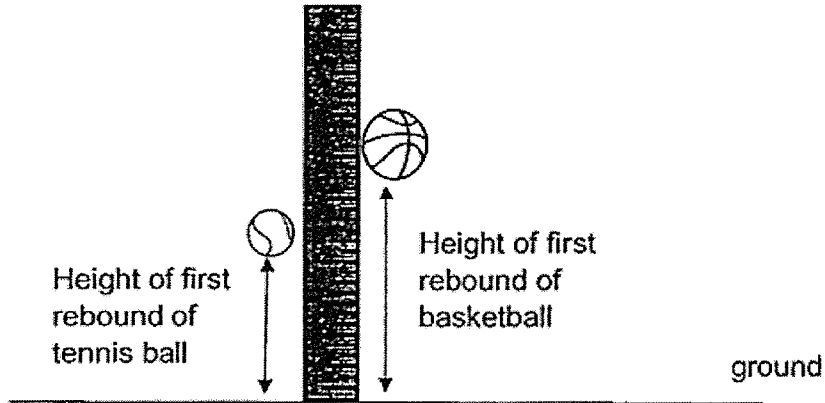

Next, he placed the tennis ball on top of the basketball as shown below before releasing them from the same height.

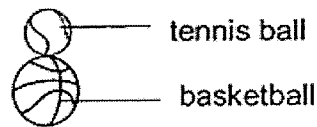

He observed that the tennis ball bounced higher into the air than before as shown below.

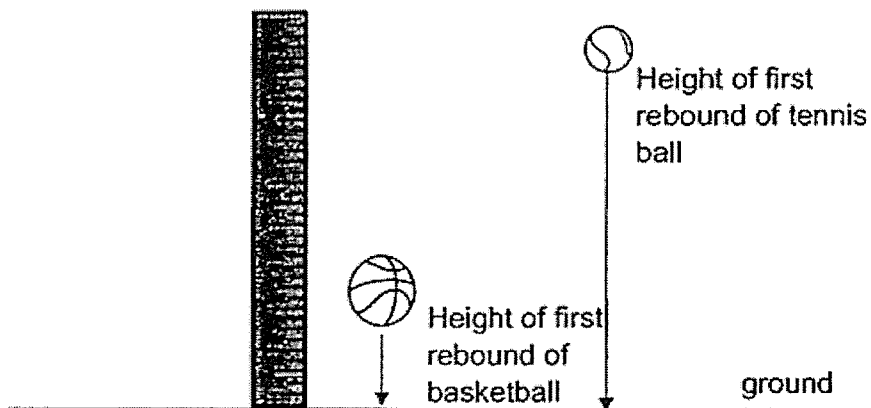

Question 20 continues on page 17

Which one of the following is the best explanation for his observation?

- (1) There was less friction between the tennis ball and the air.
- (2) There was less friction between the basketball and the tennis ball.
- (3) The gravitational potential energy of the basketball was converted to kinetic energy of the tennis ball.
- (4) The elastic potential energy of the compressed basketball when it hit the ground was converted to kinetic energy of the tennis ball.

21 Which one of the following is an example of the effect of a force?

- (1) Leaves falling from a tree.
- (2) Ice cubes melting on a table top.
- (3) Fish being cooked by the steam in a food steamer.
- (4) A puddle of water gaining heat from the sun and evaporating.

- 22 The diagram shows a cylinder and a plunger. When the cylinder was filled with substance P, the plunger was able to be pushed down to a certain extent but not when it was filled with substance Q.

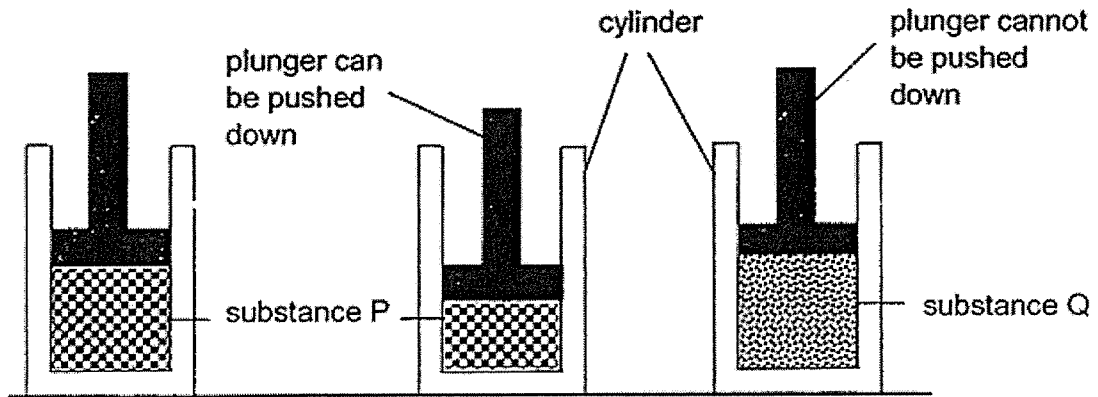

Based on the observations, which of the following are correct?

- A Substance Q has definite volume.
 - B Substance Q has a definite shape.
 - C There are air spaces in substance P.
- (1) A and B only
 (2) A and C only
 (3) B and C only
 (4) A, B and C

23 The diagram below shows the different processes, A, B, C, D, E and F, in a water cycle.

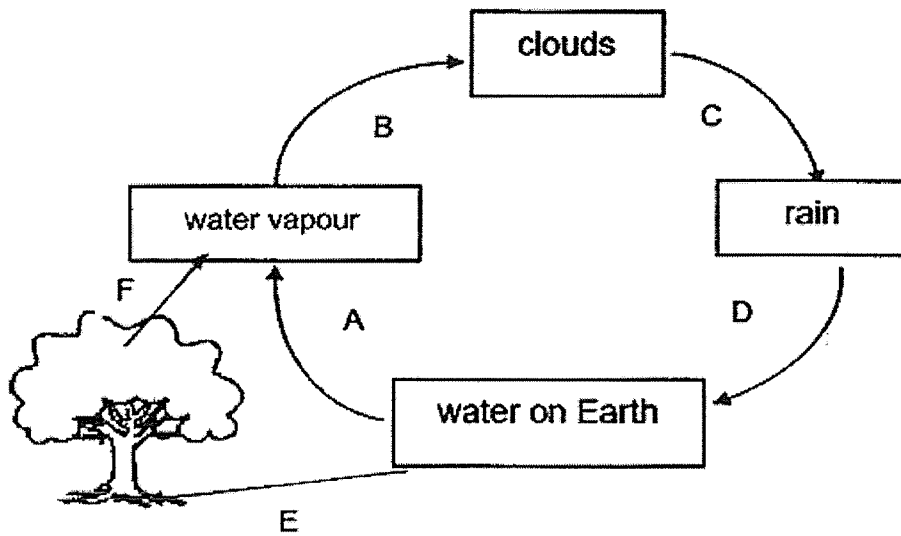

Which one of the following is correct?

	Involve a change of state	Involve(s) heat loss
(1)	A and B	B
(2)	A, B and F	B
(3)	A, B and F	C
(4)	B, C, D and E	C

- 24 Ahmad wanted to find out how the volume of water will affect the temperature of hot water over a period of time. He used four identical containers to set up P, Q, R and S as shown below.

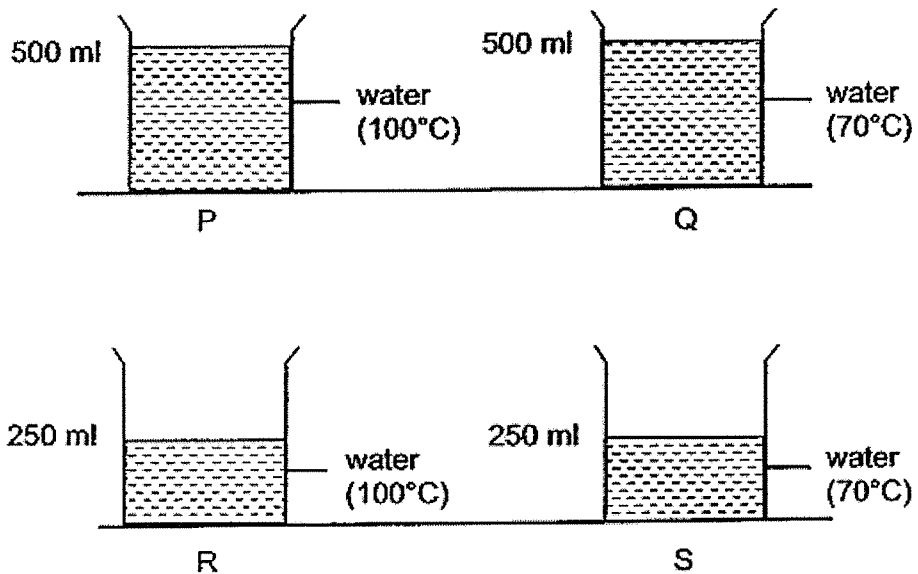

Which two set-ups should he use for his experiment?

- (1) P and Q only
- (2) P and R only
- (3) Q and R only
- (4) R and S only

- 25 There were two identical cups, A and B, containing same amount of hot water on a table. The water was at the same temperature in both cups. Bala placed a piece of bubble wrap onto cup A as shown in the diagram below.

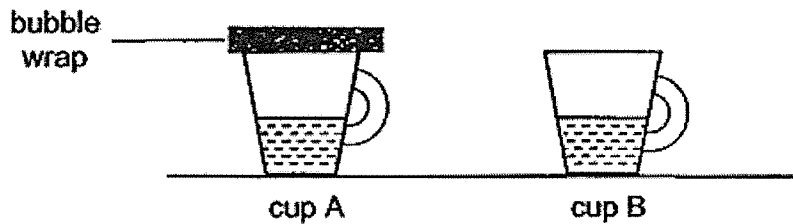

After five minutes, Bala observed that the water in cup A had a higher temperature than that in cup B.

Which of the following could be the most likely reason for the observation above?

- (1) Heat was transferred from the bubble wrap to the water in cup A.
 - (2) The bubble wrap increased the rate of evaporation of the water in cup A.
 - (3) The bubble wrap increased the rate of condensation of the water in cup A.
 - (4) The bubble wrap reduced the heat transfer from the water in cup A to the surroundings.
- 26 Study the circuit.

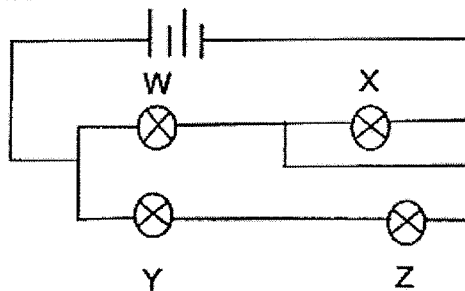

Which bulb when blown allows the other three bulbs to remain lit?

- (1) W
- (2) X
- (3) Y
- (4) Z

- 27 Ravi placed a book on a wooden plank as shown in Diagram 1. He raised the wooden plank till the book starts to slide down and then he measured the angle of plank as shown in Diagram 2.

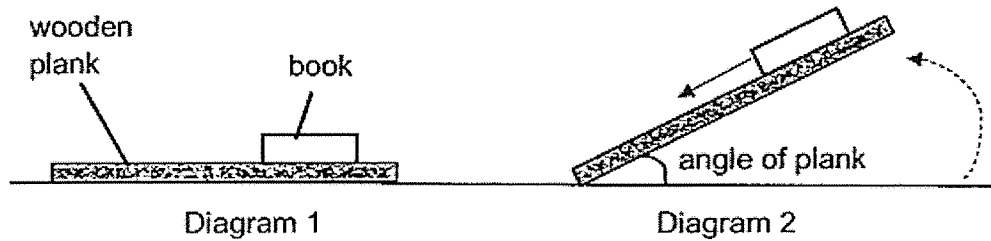

The table below shows the results for different types of wooden planks, A, B and C.

Wooden Plank	Angle of plank when the book starts to slide down (°)
A	20
B	70
C	50

Which of the following correctly shows the relationship between the angle of plank and the amount of friction between the plank and the book?

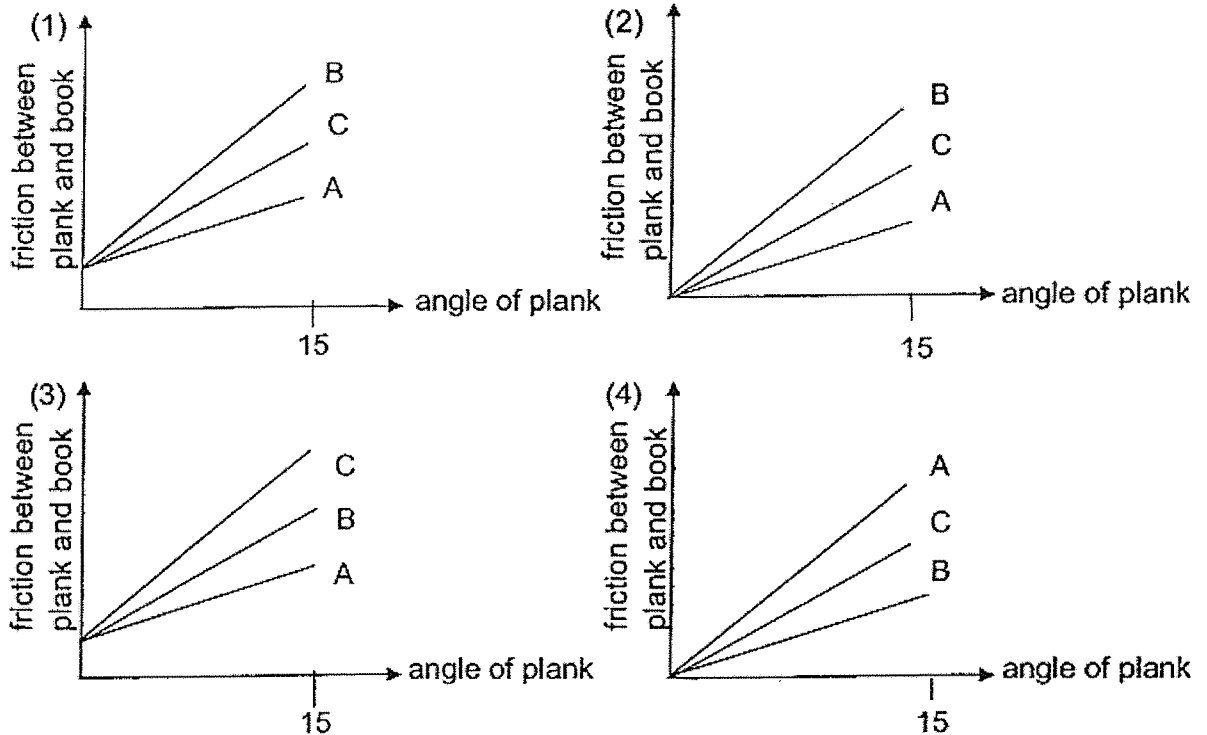

- 28 Asri used a trolley to push some boxes for delivery. He was able to push the trolley faster after each box was delivered.

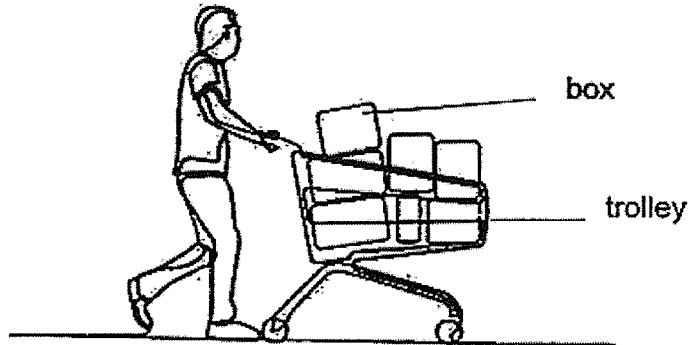

Which of the following explain the phenomenon?

- A There was less friction between the trolley and the floor.
- B He has to overcome less gravitational force between the trolley and the Earth.
- C More kinetic energy of Asri was converted to more kinetic energy of the trolley.

- (1) A and B only
- (2) A and C only
- (3) B and C only
- (4) A , B and C

(go to Booklet B)



Rosyth School
Preliminary Examination 2020
SCIENCE
Primary 6

Name: _____

Total
Marks:

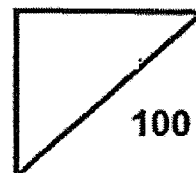

Class: Pr 6- _____, Register No. _____

Total time for
Booklets A and B: 1 h 45 min

Date: 27 August 2020

Parent's Signature: _____

Booklet B

Instructions to Pupils:

For questions 29 to 40, write your answers in the spaces given in this booklet.

	Maximum	Marks Obtained
Booklet A	56 marks	
Booklet B	44 marks	
Total	100 marks	

* This booklet consists of 19 printed pages (including cover page).

For questions 29 to 40, write your answers in the space provided.

[44 Marks]

29 May conducted an experiment with two fruits, T and U, as shown.



She dropped fruit T and U from a height of 120 cm in front of a fan. She measured the distance, d , travelled by the fruits.

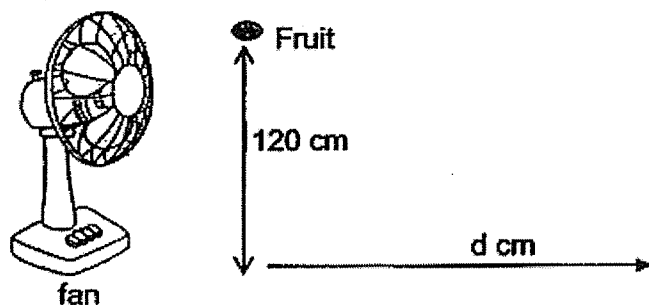

The results are shown below.

Fruit	T	U
Distance, d / cm	5	50

(a) State the method of dispersal for fruit T and fruit U. [1]

Fruit T: _____ Fruit U: _____

Question 29 continues on page 3

(b) Explain why the distance travelled by fruit U is further. [1]

(c) How do young plants benefit when they grow further away from the parent plants? [1]

30 Hani wanted to investigate the process of digestion in human body using digestive juices. The diagram shows the two test-tubes, X and Y, at the start of experiment.

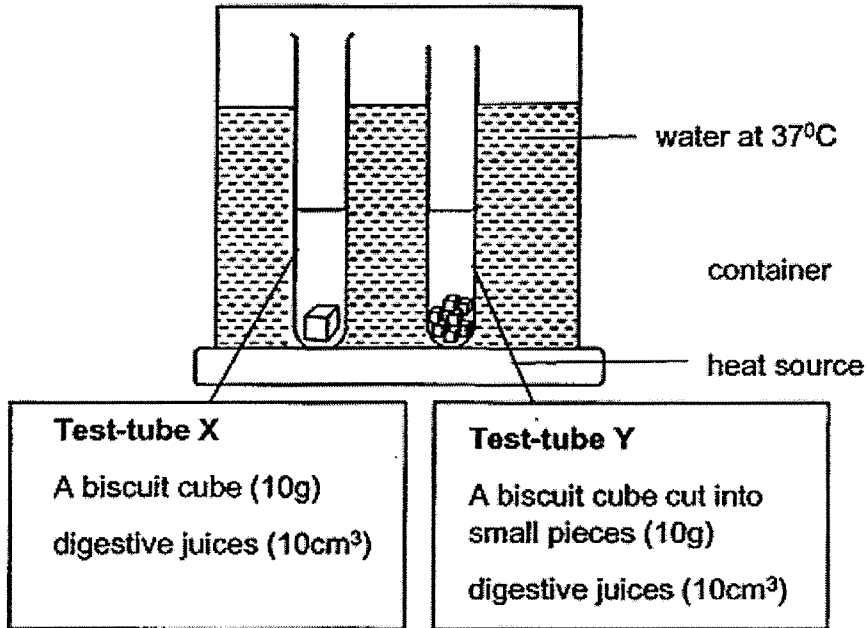

He measured the time for the biscuits to be completely digested.

(a) Give a reason why Hani choose a temperature of 37⁰ C for the water in the container. [1]

(b) In which test tube would the biscuit be completely digested first? Explain why. [2]

Question 30 continues on page 5

Hani studied the body systems in the human body as shown below. The arrows represent the flow of blood.

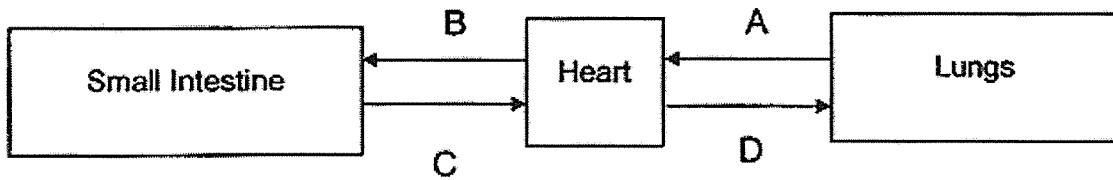

(c) Which arrow represents the blood rich in digested food? [1]

Arrow: _____

(d) Describe how oxygen in the lungs reach the other parts of the body? [1]

- 31 May Ling investigated the volume of water taken in by plants using set-up A as shown below. She filled the tube with water until it reached the brim of the measuring instrument. Then she made a plant cutting to put in the tube and sealed it tightly.

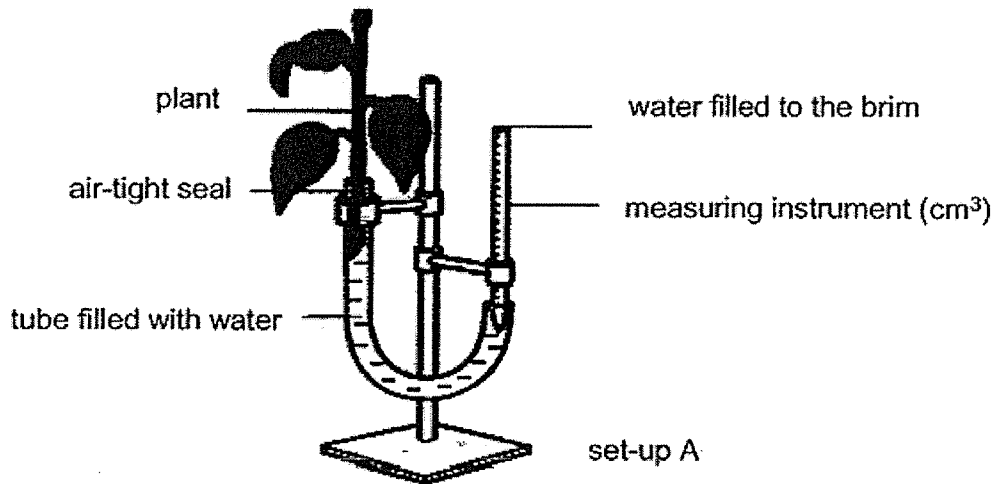

She measured the volume of water taken in by the plant in 30 minutes.

- (a) How did she measure the volume of water taken in by the plant? [1]

She repeated her experiment in the similar condition using two other set-ups, B and C, applying oil on different surfaces of the leaves as shown in the table below.

Set-up	Upper surface	Lower surface
B	Oil applied	No oil applied
C	No oil applied	Oil applied

†, Question 31 continues on page 7.

She recorded the volume of water taken in by the plant as shown below.

Set-up	Volume of water taken in by plants in 30 minutes (cm ³)
A	10
B	6
C	4

Leaves have tiny openings on their surfaces.

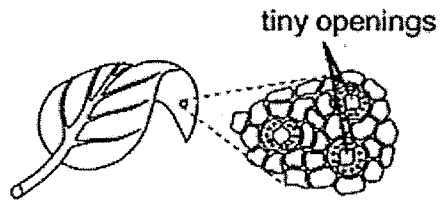

- (b) State one function of the tiny openings. [1]

- (c) Based on the results in the table above, which surface of leaves (upper or lower) has more tiny openings?

Using only the materials shown below, describe a method and the observation to show your answer. [2]

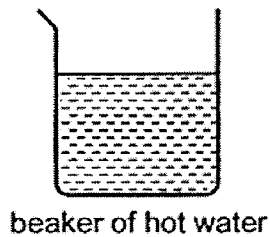

Method:

Observation:

- 32 Paul left a piece of fruit in an open container A. After three days, he found maggots on a piece of fruit as shown below.

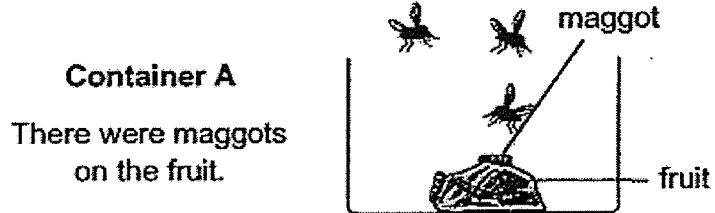

He researched and found out that maggots are the larvae of fruit flies.

- (a) Draw and label the life cycle of the fruit fly in the box below. [1]

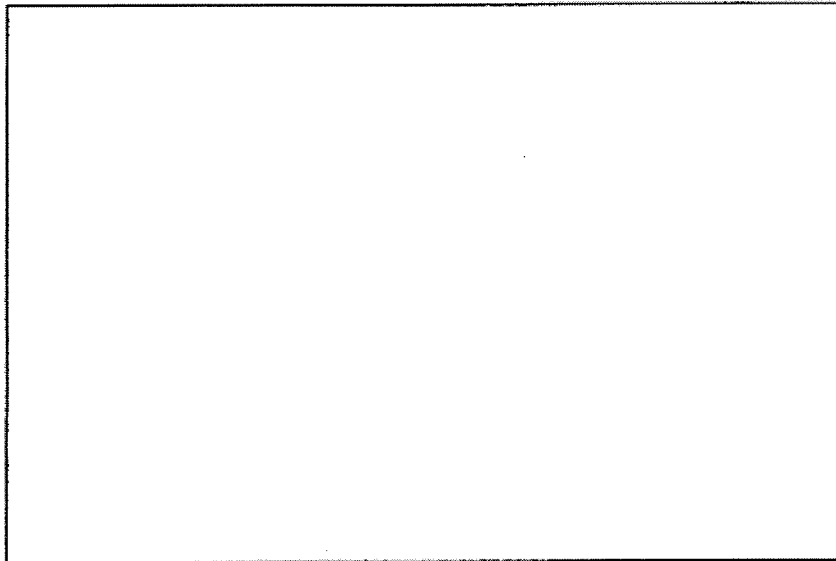

Question 32 continues on page 9

Paul wanted to investigate if the type of seal of the container would affect the life cycle of fruit flies.

He placed a piece of fruit of the same size in two set-ups. After three days, the results were as shown below.

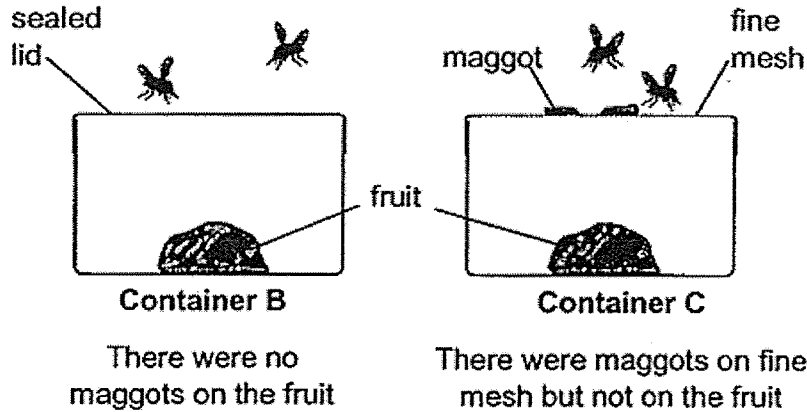

- (b) Explain why the maggots that hatched on the fine mesh in container C could not complete their life cycle. [1]

- (c) Can containers, A and B, be used to confirm that maggots did not come from fruit? Explain why. [2]

- 33 Andrew wants to investigate how temperature of water affects the number of bubbles produced by the water plant in one minute. He set up the experiment as shown below in a lit room.

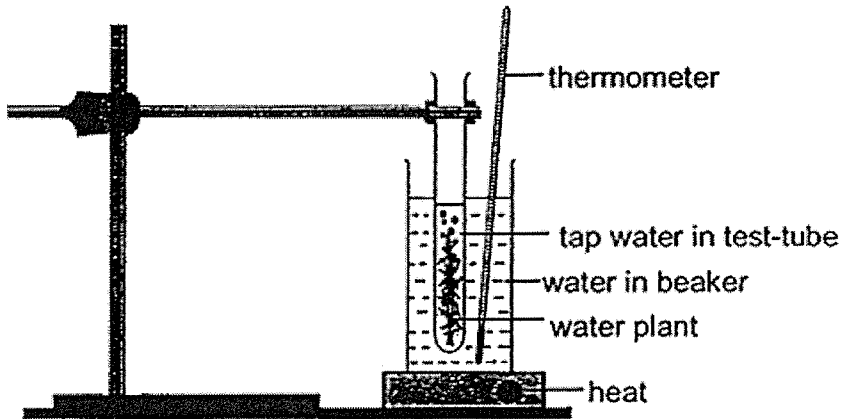

- (a) State all the requirements for the water plant to produce the bubbles. [1]

Andrew counted the number of bubbles produced at different temperatures. His results are shown on the graph below.

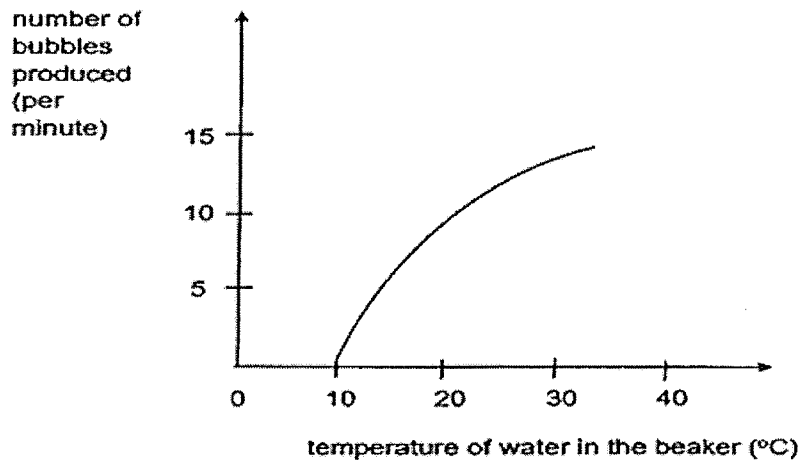

- (b) State the relationship between the temperature of water and the number of bubbles produced. [2]

- 34 Melvin wanted to find out how the amount of oxygen and carbon dioxide changes in a plant. He placed a plant in a sealed glass container in a bright place.

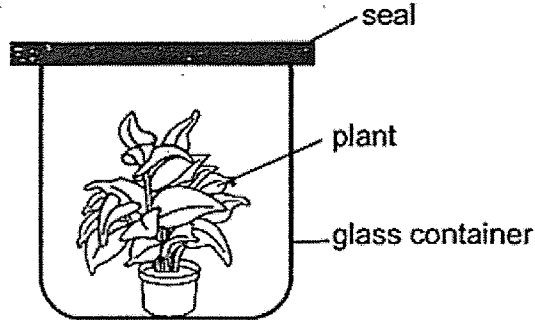

He carried out his experiment and using his results, he plotted the graphs as shown below.

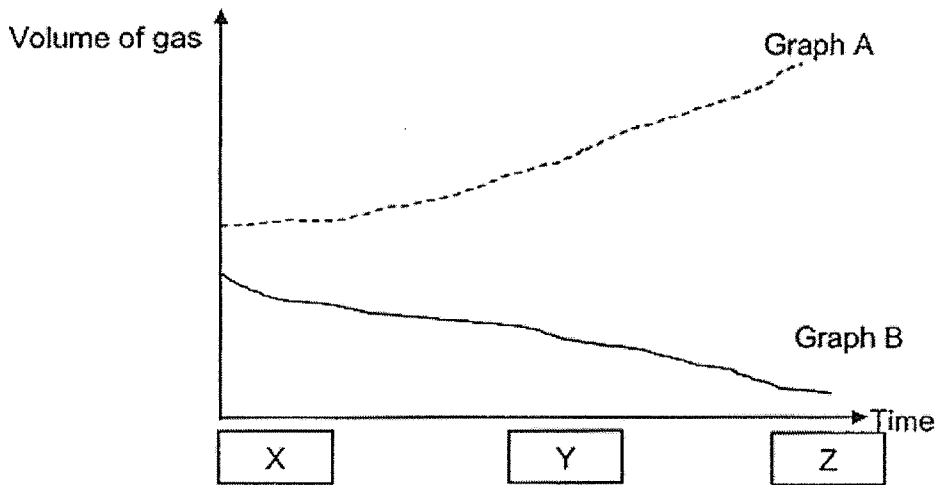

- (a) Identify the gases for Graph A and Graph B. [1]

Graph A: _____

Graph B: _____

- (b) Which letter, X, Y or Z represent 'Noon Time'? Explain why. [2]

- 35 Kumar placed three steel paper clips into a glass beaker containing liquid X. He used the North pole (N) of the magnet to touch the glass beaker as shown below.

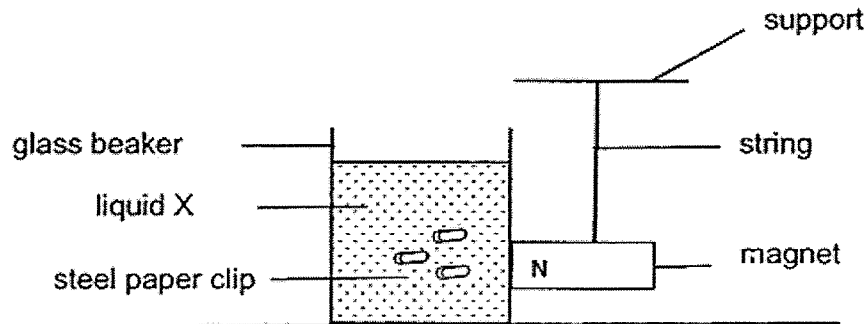

- (a) State a property of magnets that Kumar is trying to show? [1]

Kumar repeated the same experiment but he changed the part of the magnet touching the glass beaker.

Using the same beaker, steel paper clips and magnet, he observed that the steel paper clips moved slower towards the magnet.

- (bi) Which part of the magnet was touching the glass beaker? Explain. [1]

- (bii) State another variable that Kumar must keep the same in the above experiment. [1]

- 36 A teacher, Mr Lim, set up the apparatus as shown. He placed it under the sun for a few hours.

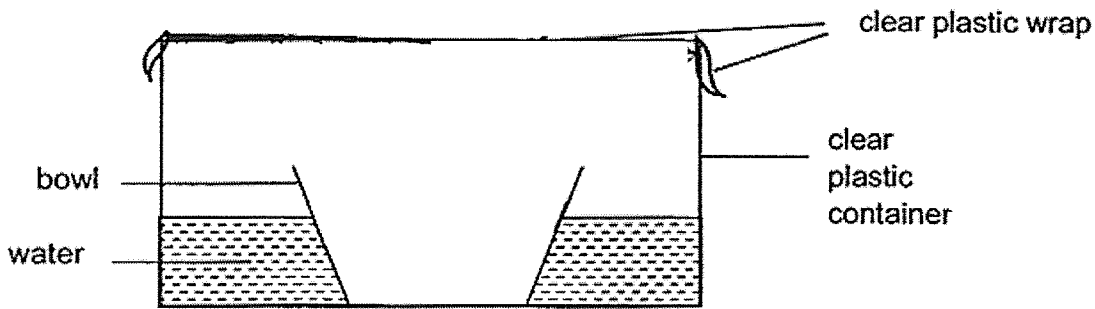

Mr Lim then observed a decrease in the water level in the container.

- (a) Draw, in the diagram above, another possible observation he can make on the plastic wrap. [1]
- (b) State the two processes involved for his observations to take place. [1]

Mr Lim's students went for a hike in a jungle and they decided to use their teacher's method to collect drinkable water as shown below.

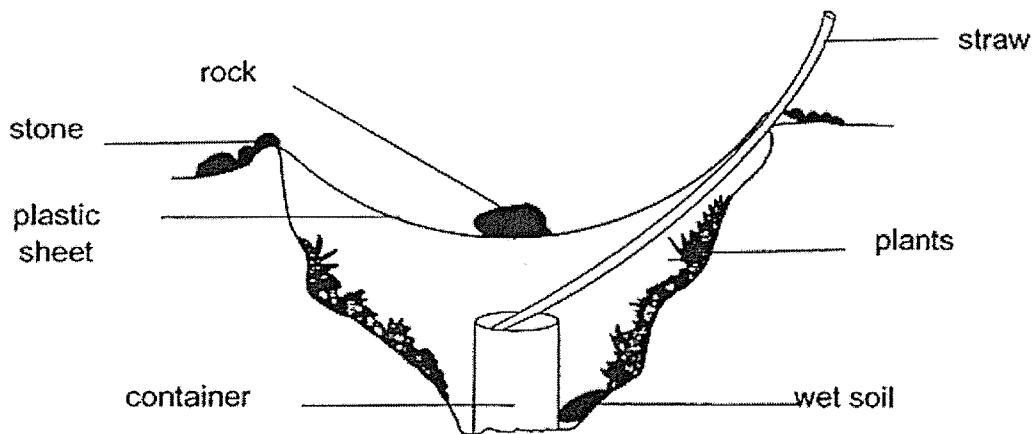

- (c) Suggest one way the students can collect more water. Explain why the method works. [2]

- 37 The graph below shows how the length of materials, P and Q, changes as temperature changes.

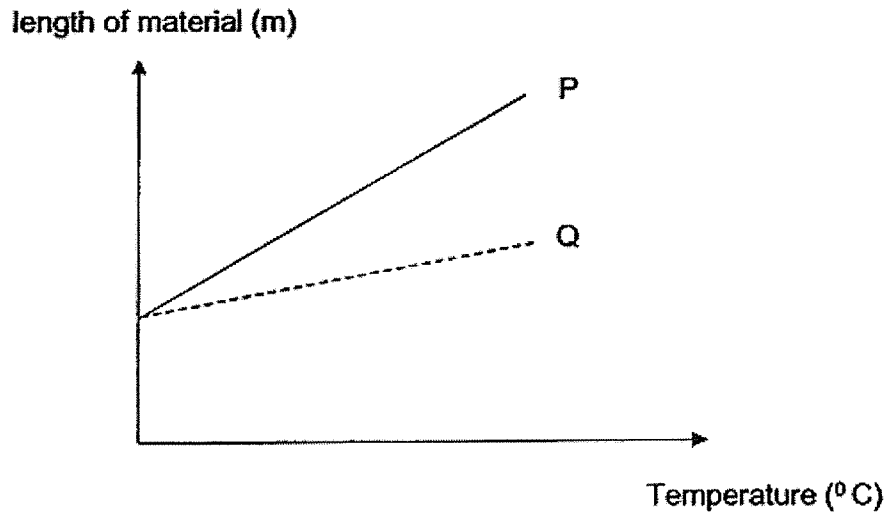

The containers made of material, P and Q, are stuck together in two different positions, (i) and (ii), as shown below.

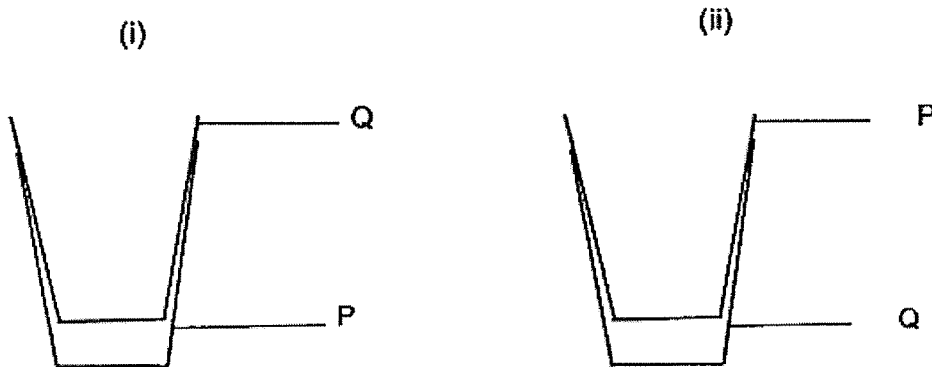

Question 37 continues on page 15

Diwei was given a basin of hot water to separate P and Q.

- (a) Based on the graph above, in which position (i) or (ii), could she use hot water to separate P and Q in a shorter time?

Draw and label to show how she could separate them. [1]

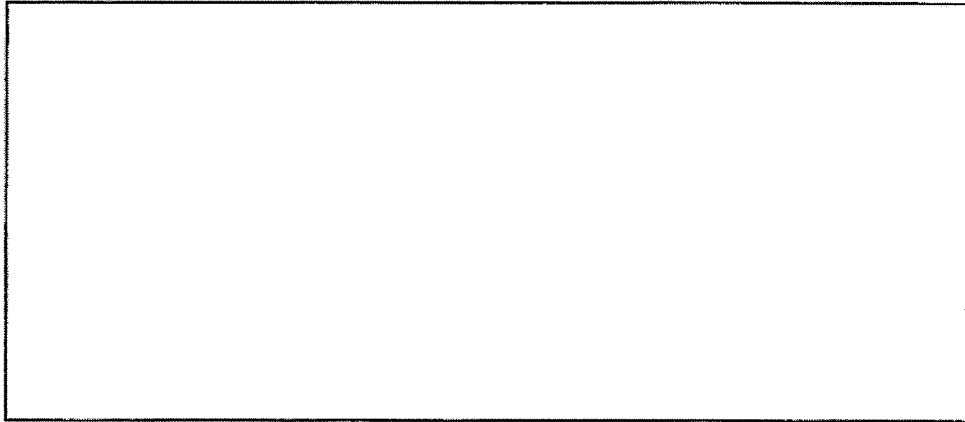

- (b) Explain how the way in (a) works to separate P and Q in a shorter time. [2]

- 38 Pauline set up the apparatus below to investigate how mass of the object in the cart affects the distance, d , travelled by the cart when it hit the floor at B and stopped at C.

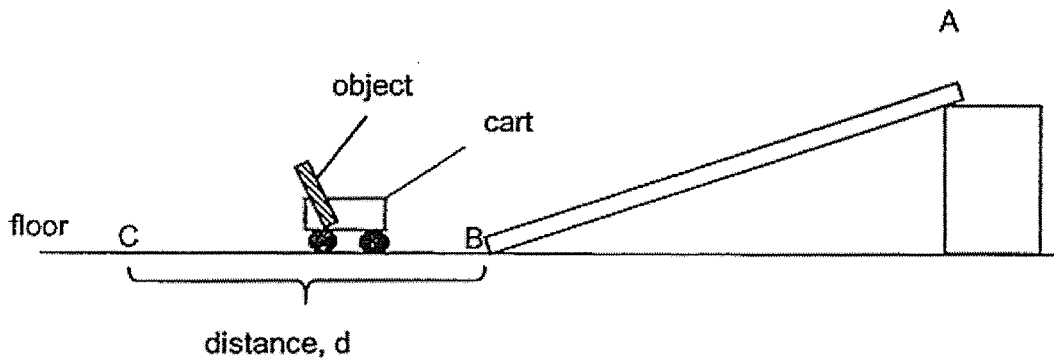

Pauline repeated the experiment using objects of different mass placed inside the cart. The results of her experiment are shown in the table below.

Mass of Object in the cart (g)	Distance, d (cm)
50	10
100	16
150	22

- (a) Fill in the boxes below to show the energy conversion as the cart moved from A to C. [1]



Question 38 continues on page 17

- (b) Explain how the mass of the object affects the distance, d , that the cart moved. [2]

- (c) Give a reason why Pauline used the same cart for her experiment.

- (d) Pauline wants to modify her set-up to find out the relationship between the height of the ramp and the distance, d . Suggest two ways to change her set-up. [1]

(i) _____

(ii) _____

- 39 Mei Ling sets up a toy house as shown in the diagram. She wants the two bulbs to be lit at the same time and of equal brightness when she closes the switch.

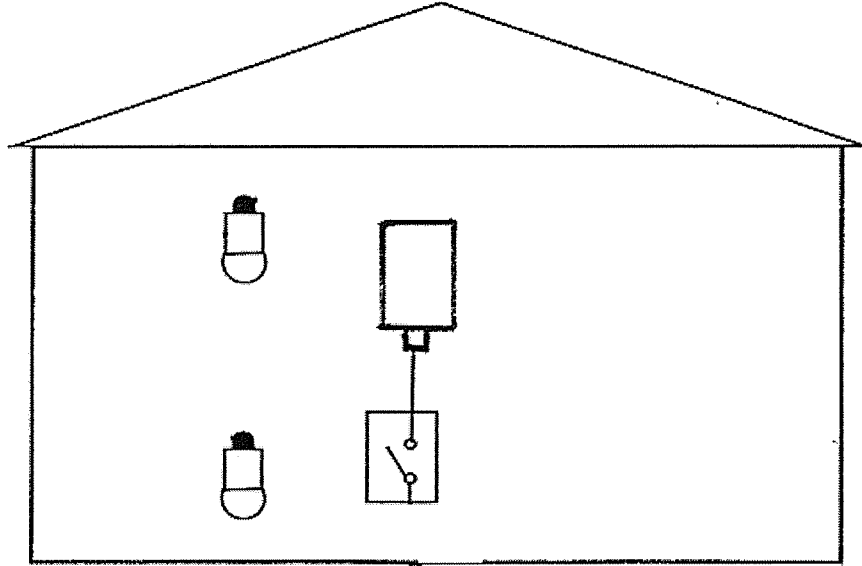

- (a) Complete the circuit in the diagram above so that it will work as described. [2]
- (b) State the arrangement of the bulbs in your drawing. [1]
-

40 Tom set up a doorbell D using two circuits containing two switches as shown.

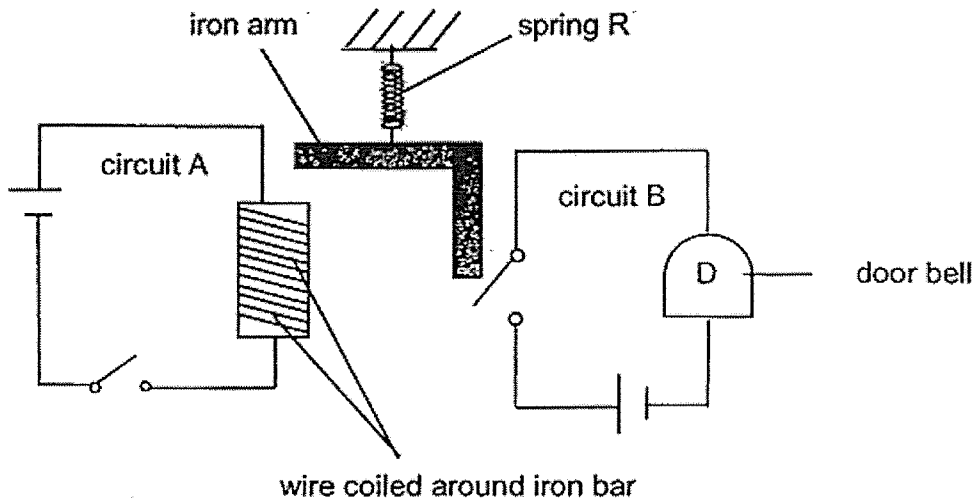

(a) Explain how the doorbell rang when Tom closed circuit A. [2]

(b) Tom replaced spring R with another spring S and observed that the doorbell did not ring when circuit A was closed. Give a reason for his observation. [1]

(c) Without changing spring S, what can Tom do if he wants the doorbell to ring when circuit A is closed? [1]

End of Paper

SCHOOL : ROSYTH PRIMARY SCHOOL
 LEVEL : PRIMARY 6
 SUBJECT : SCIENCE
 TERM : 2020 PERLIM

SECTION A

Q 1	Q2	Q3	Q4	Q5	Q6	Q7	Q8	Q9	Q10
1	1	3	2	4	4	4	3	3	1
Q 11	Q12	Q13	Q14	Q15	Q16	Q17	Q18	Q19	Q20
2	3	4	4	3	3	1	3	1	4
Q 21	Q22	Q23	Q24	Q25	Q26	Q27	Q28		
1	2	2	2	4	1	2	2		

SECTION B

Q29)	<p>a)T: animal U: wind</p> <p>b)U had fine hairs that help it stay in the air longer to travel a further distance.</p> <p>c)Competition between young plants and parent plants for light, water, space and nutrients would be reduced.</p>
Q30	<p>a)37°C is close to the human body temperature.</p> <p>b)Test-tube Y. In test-tube Y, the biscuit cube had greater surface area in contact with the digestive juices, allowing the digestive juices to digest it completely faster.</p> <p>c)C</p> <p>d)Oxygen in the lungs enter the bloodstream to the heart. The heart then pumps the oxygen to the other parts of the body.</p>
Q31	<p>a)The difference in the water level in the measuring instrument.</p> <p>b)The tiny openings allow gaseous exchange.</p> <p>c)Method: Put the leaf in the beaker of hot water.</p>

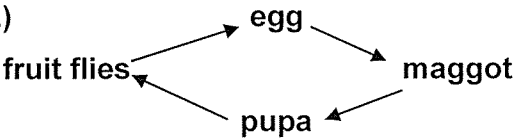
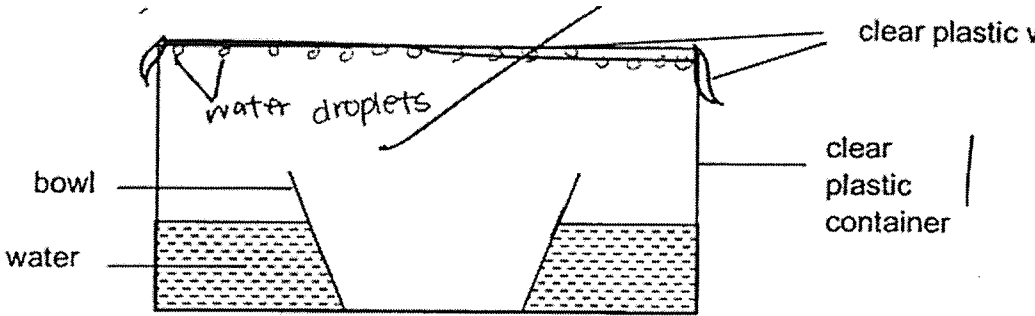
	<p>Observation: More air bubbles will form on the lower surface of the leaf.</p>
Q32	<p>a)</p>  <p>b)The maggots had no food and will starve to die, thus, it could not complete their life cycle.</p> <p>c)Yes. In container A, there was no sealed lid and there were maggots on the fruit, in container B, there was a sealed lid and no maggots on the fruits, proving that maggots did not come from fruit.</p>
Q33	<p>a)The presence of water, carbon dioxide, light and chlorophyll.</p> <p>b)As the temperature of water increases, the number of bubbles produced increases.</p>
Q34	<p>a)A: oxygen B: carbon</p> <p>b)Z. The volume of oxygen was highest at Z. There is the most amount of light during “Noon Time”, hence, the plant would photothesise the most to make the most food and release the most oxygen.</p>
Q35	<p>a)Magnetic force can pass through non-magnetic materials.</p> <p>bi)The middle part. The steel paper clips moved slower towards the magnet proving there was less magnetic force of attraction acting on it. The middle part of a magnet is magnetically the weaker than poles.</p> <p>bii)The type of liquid used.</p>
Q36	<p>a)b</p>  <p>b)evaporation and condensation</p> <p>c)They can replace the rock with an ice cube. The ice cube would lower the temperature of the plastic sheet, allowing more heat loss to</p>

	<p>and condensation on the plastic sheet of more warmer water vapour into more water droplets that drip into the contain.</p>
<p>Q37)</p>	<div data-bbox="384 434 1070 734" data-label="Diagram"> </div> <p>a)</p> <p>b) P is a better conductor of heat than Q and would gain more heat faster and expand faster.</p>
<p>Q38)</p>	<p>a) gravitational potential energy \rightarrow kinetic energy \rightarrow heat energy \rightarrow sound energy.</p> <p>b) The greater the mass of the object in the cart, the greater the total mass of the cart and hence, the greater the gravitational potential energy the cart has that converted to more kinetic energy of the cart, allowing it to travel a greater distance, d.</p> <p>c) To ensure that any change in the distance, d, travel by the cart is solely due to the mass of the object in the in the cart and not the mass of the cart.</p> <p>d) i) place objects of the same mass in the cart . ii) Change the height of the ramp.</p>
<p>Q39)</p>	<div data-bbox="368 1659 699 1868" data-label="Diagram"> </div> <p>b) series</p>

Q40)	a)When Tom closed circuit A, a closed circuit was formed and electric current flew through the iron bar, magnetizing it into an electromagnet . The electromagnet attracted the iron arm,causing the iron arm to close circuit B an allow electric current to flow through door bell D ringing it, b)Spring S was stiffer and did not expand enough for the iron arm to close circuit B. c)He can move circuit B closer to the iron arm.