

NANYANG PRIMARY SCHOOL
PRIMARY THREE SCIENCE
SEMESTRAL ASSESSMENT 2

2012

BOOKLET A

Date : 11 October 2012

Duration : 1 h 45 min

Name : _____ ()

Class: Primary 3 ()

Parent's signature:

**DO NOT OPEN THIS BOOKLET UNTIL YOU ARE TOLD TO DO SO.
FOLLOW ALL INSTRUCTIONS CAREFULLY.**

Booklet A consists of 20 printed pages including this cover page.

Section A (30 x 2 marks = 60 marks)

For each question from 1 to 30, four options are given. One of them is the correct answer. Make your choice (1, 2, 3 or 4). Shade the correct oval (1, 2, 3 or 4) on the Optical Answer Sheet provided.

1. Jonas put some male hamsters in a container with wire gauze covering the top. He only gave the hamsters enough water each day for a period of 3 weeks. At the end of each week, he counted the number of hamsters and plotted his result.

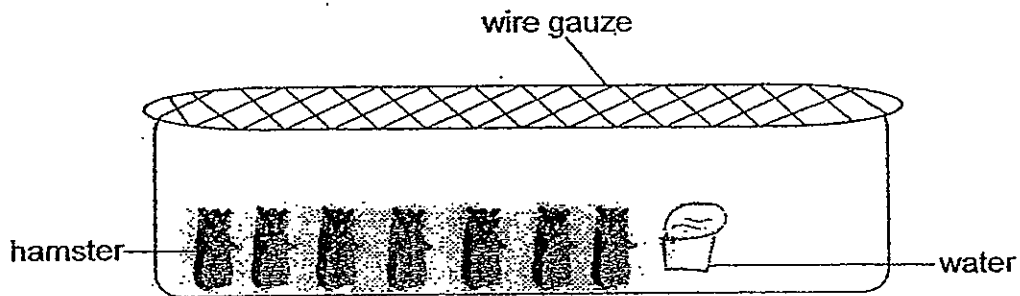

Which one of the following shows the graph that he had correctly plotted based on his experiment?

(1)

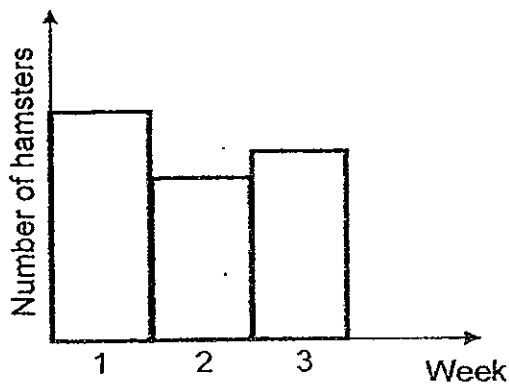

(2)

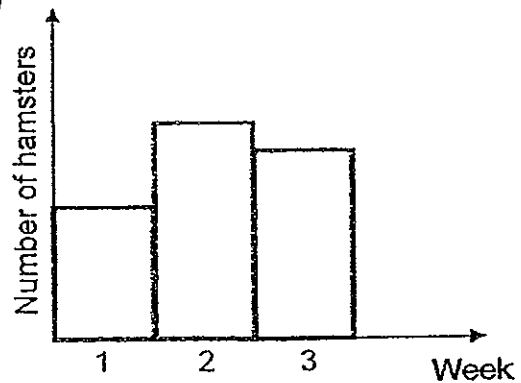

(3)

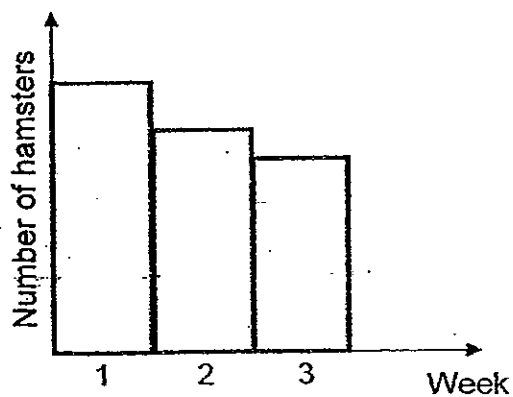

(4)

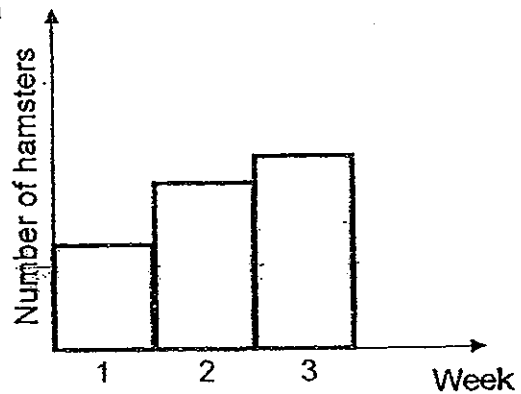

2. Which of the following statements **correctly** describe the similarities between plants and animals?

- A They can reproduce.
- B They respond to changes.
- C They look after their young.
- D They need air, food, water and sunlight.

- | | |
|---------------------|---------------------|
| (1) A and B only | (2) B and C only |
| (3) A, C and D only | (4) B, C and D only |

3. Lucy made the following statements about bacteria and fungi.

- A All bacteria are harmful and cause diseases.
- B Bacteria and fungi are known as decomposers.
- C Fungi needs air, warmth and water in order to live.
- D Fungi and bacteria can only be seen under a microscope.

Which of the statements above are **incorrect**?

- | | |
|------------------|---------------------|
| (1) A and B only | (2) A and D only |
| (3) B and C only | (4) A, C and D only |

4. The diagrams below show a Bird's nest fern and a Bracket fungus.

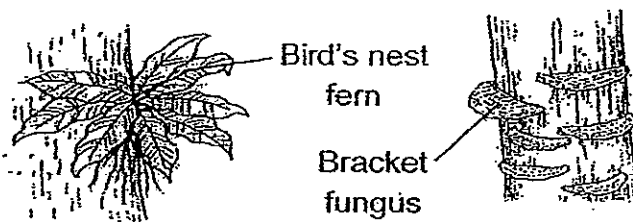

Which of the following statements about the two organisms are correct?

- A Both organisms can grow on trees.
- B Both organisms can show growth movements.
- C Both organisms need sunlight in order to survive.
- D Both organisms depend on the host tree for food.

- (1) A and B only
- (3) B and C only

- (2) A and D only
- (4) C and D only

5. Study the classification chart below. A and B represents suitable headings for the flow chart.

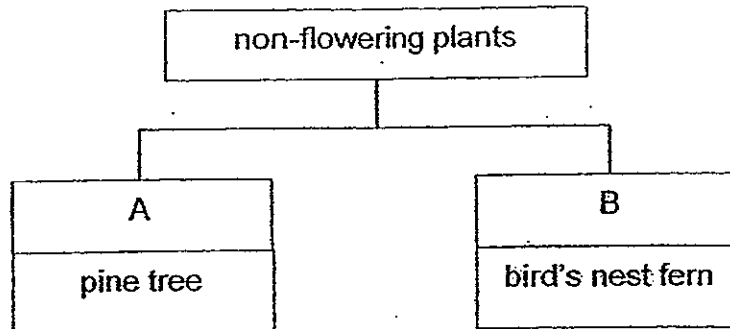

Which one of the following headings best represents A and B?

	A	B
(1)	reproduces by spores	reproduces by seeds
(2)	reproduces by seeds	reproduces by spores
(3)	lives on land	lives only on trees
(4)	lives only on trees	lives on land

6. Four plants, A, B, C and D, are observed for the characteristics as shown in the table below. A tick (✓) shows that the plant has the characteristic.

	A	B	C	D
Grows on land			✓	✓
Bears fruit	✓		✓	

Which one of the following statements about plants A, B, C and D is correct?

- (1) Grass is an example of plant B.
- (2) Plants A and C are aquatic plants
- (3) Water Lily is an example of plant A.
- (4) Plants A and D reproduce by seeds.

7. A dolphin was being transported from one water theme park to another. The dolphin was placed on a stretcher and water was poured on the dolphin from time to time.

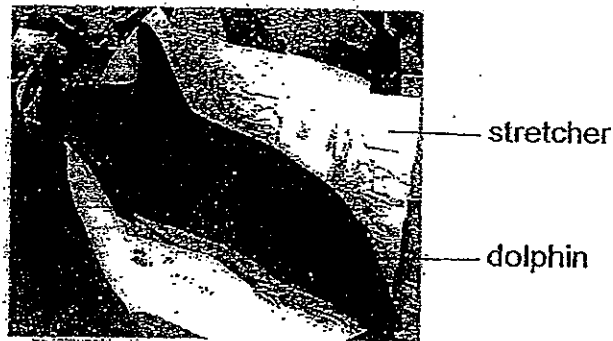

Which of the following statements best explained why the dolphin was still alive when it reached the new water theme park?

- (1) The dolphin could breathe using its lungs.
 - (2) The water poured on the dolphin gave it oxygen.
 - (3) The dolphin had stored enough oxygen in its body to last throughout the journey.
 - (4) Dolphins can take in both dissolved oxygen in water and oxygen from the surrounding.
8. The diagrams below show 4 organisms, A, B, C and D.

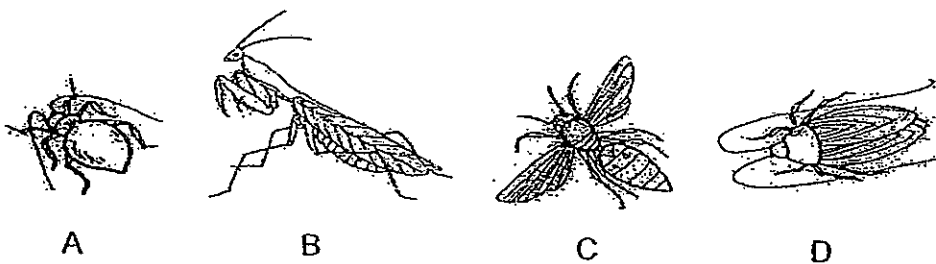

Based only on what you can see from the diagrams above, which one of the following statements is correct?

- (1) All of them have a pair of wings.
- (2) All of them have a pair of feelers.
- (3) Only organism B has two body parts.
- (4) Their bodies are covered with a shell.

9. Study the flow chart below.

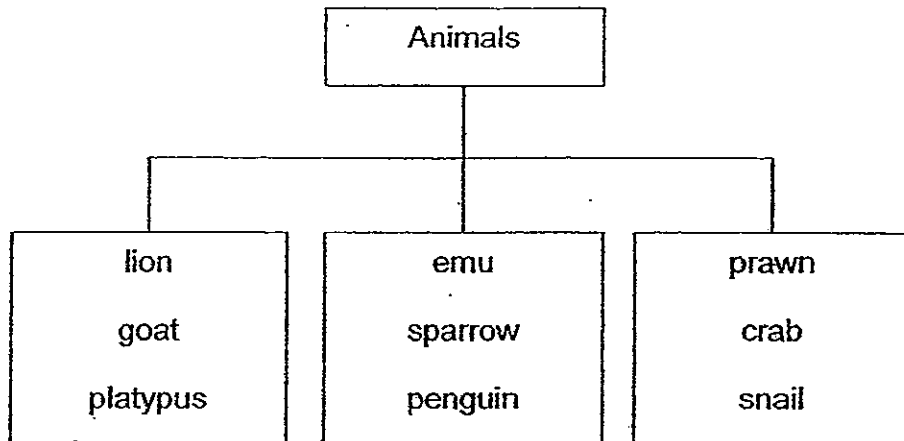

How have the animals above been classified?

- (1) According to their diet.
 - (2) According to the way they move.
 - (3) According to their body coverings.
 - (4) According to the number of legs they have.
10. Which one of the following animals can move differently from its young?
- (1) turtle
 - (2) lizard
 - (3) butterfly
 - (4) water buffalo

11. Study the classification chart below carefully.

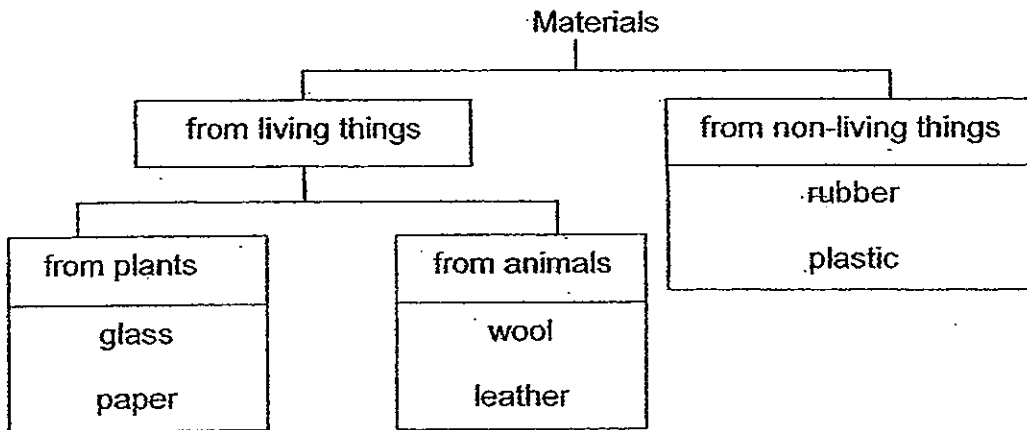

Which of the above materials have been **wrongly** classified?

- (1) paper and wool
- (2) glass and plastic
- (3) wool and leather
- (4) glass and rubber

12. The diagrams below show different types of leaves.

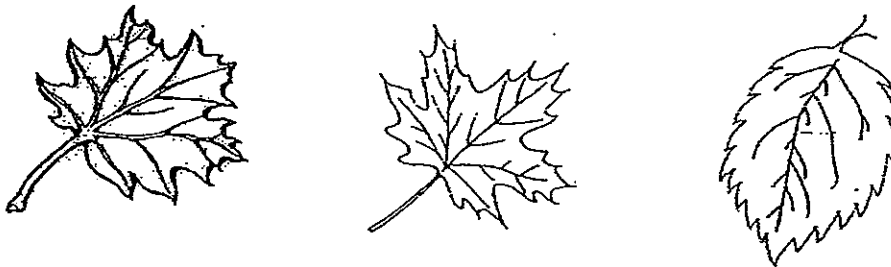

Which one of the following statements about the leaves above is **correct**?

- (1) The leaves have similar vein patterns and edges.
- (2) The leaves have similar vein patterns and shapes.
- (3) The leaves have different vein patterns but similar edges.
- (4) The leaves have different vein patterns but similar shapes.

13. Plants lose water to their surrounding through their leaves. In deserts, the leaves are smaller in size.

Which one of the following best explains why the leaves of desert plants are smaller in size?

- (1) To absorb more moisture from the surroundings.
- (2) To prevent the leaves from overheating and burning.
- (3) To reduce the amount of water lost to its surroundings.
- (4) To prevent animals which are seeking shelter from destroying the plant

14. Four similar plants had different parts of it removed as shown in the table below.

Plant	Parts removed
A	flowers
B	buds
C	fruits
D	roots

Which one of the following plants is most likely to dry up first?

- (1) Plant A
- (2) Plant B
- (3) Plant C
- (4) Plant D

15. Study the diagrams of the plants below.

Which one of the following plants will be most difficult to uproot from the soil than the others?

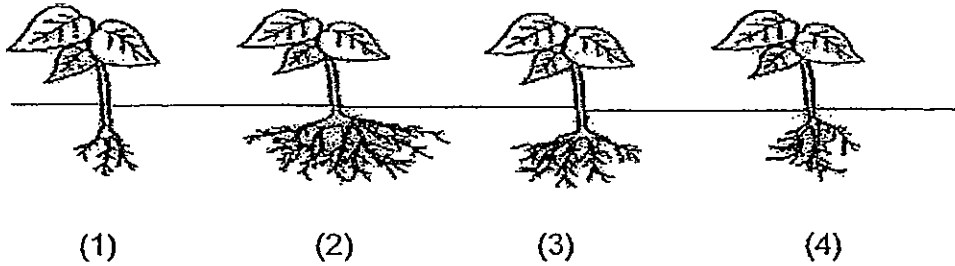

16. Study the diagrams of the two plants below.

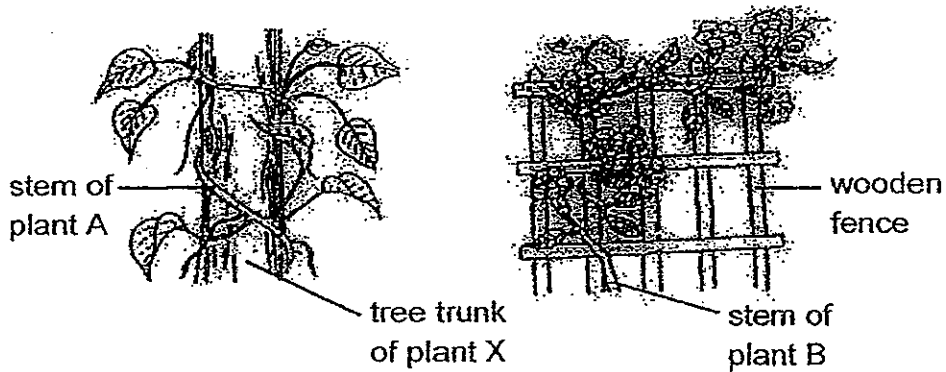

Which one of the following statements is true of plants A and B above?

- (1) Plant A and B cannot make their own food.
- (2) The stems of plants A and B allow the plants to stand upright.
- (3) Both plants A and B feed on the tree trunk and wooden fence.
- (4) Plant A climb up the tree while plant B climb up the fence to get sunlight.

17. Dan was given four types of materials, W, X, Y and Z to make a tent for his camping trip. He tested the materials and used a checklist as shown below to record the results. A tick (✓) indicates that the material had that property.

	W	X	Y	Z
It is light.	✓	✓	✓	
It is waterproof.	✓	✓		✓
It tears easily.				✓
It is dark coloured.	✓		✓	✓

Which two materials had the necessary properties for making a suitable tent?

- (1) W and X only (2) W and Y only
 (3) X and Y only (4) X and Z only
18. Aslina had four strings, A, B, C and D, of the same length and thickness but made of different materials. She tested the strength of the strings by adding 10 g weights on each string until it broke.

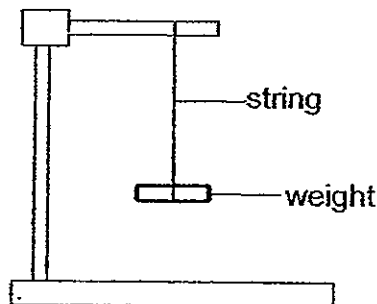

The table below shows the maximum number of weights each string could hold before it broke.

String	A	B	C	D
Number of 10 g weights added	20	10	2	7

Which one of the following conclusions could be drawn from the results?

- (1) String C was stronger than String A.
 (2) Strings B and D had the same strength.
 (3) String C could be used to lift up 50 g of salt.
 (4) String A had twice the strength of string B.

19. Which one of the following objects does not contain a magnet to carry out its function?

(1)



compass

(2)



credit card

(3)



refrigerator

(4)

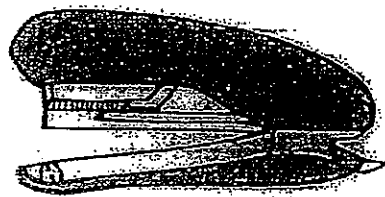

stapler

20. Study the classification chart below carefully. The chart shows the properties of some materials, P, Q, R, S and T.

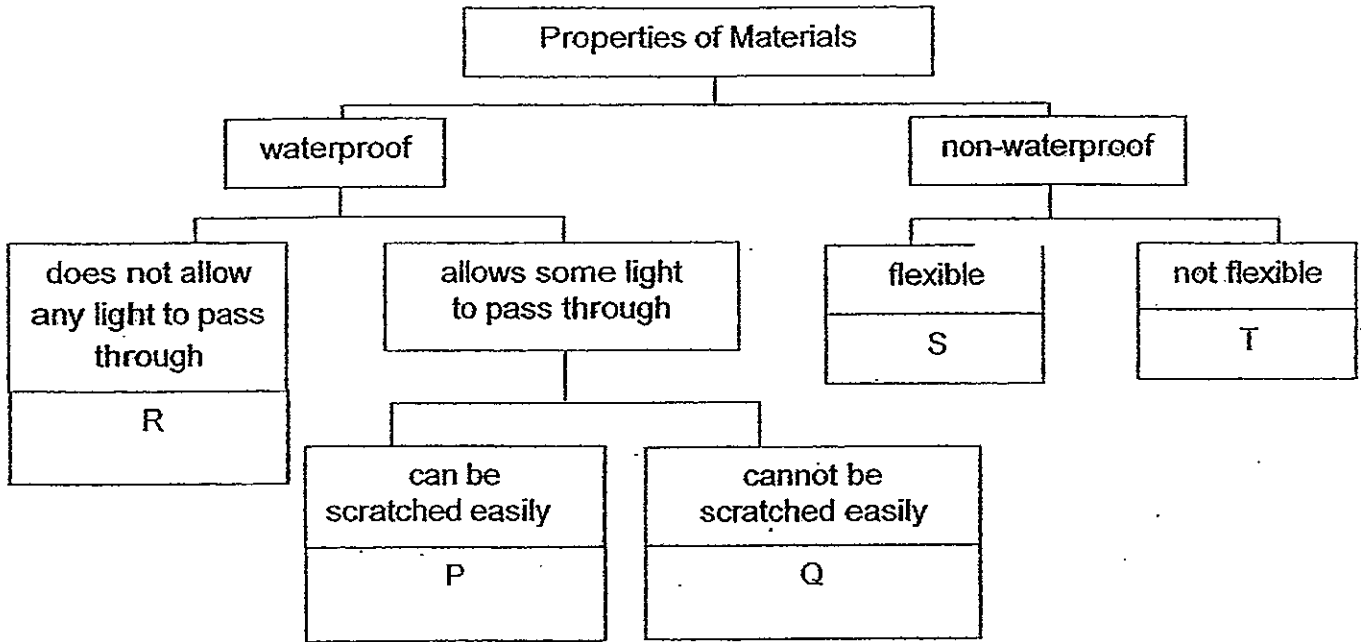

Based on the classification chart, which of the following materials are most suitable for making the lenses of sunglasses and a bath towel respectively?

	Sunglasses	Bath towel
(1)	P	S
(2)	Q	S
(3)	Q	T
(4)	R	T

21. Which one of the following methods will **not** cause a magnet to lose its magnetism?

- (1) Dropping it several times (2) Heating it over a flame
 (3) Hammering it several times (4) Putting it inside water

22. Felix was given 3 objects, A, B and C, which were wrapped with a black paper. He was told that the objects were a magnet, a magnetic object and a non-magnetic object.

He then hung the objects from the ceiling using strings and placed them in different positions. The diagrams below show what happened when the objects were put together.

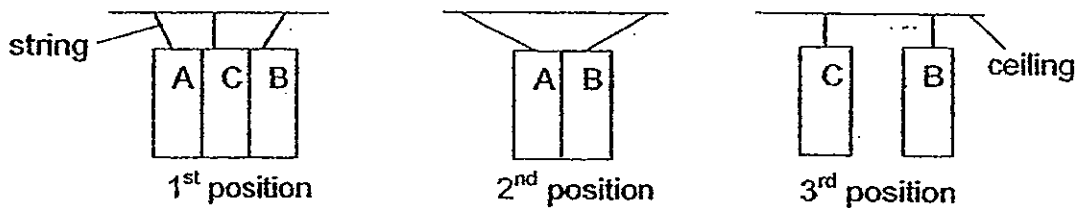

Object C was removed. Object A was removed.

Based on the observation above, which one of the following is a possible conclusion?

	Magnet	Magnetic Object	Non-magnetic Object
(1)	(1) A	B	C
(2)	(2) A	C	B
(3)	B	C	A
(4)	(3) C	A	B

23. Which one of the following statements is **not** true about magnets?

- (1) The Earth itself is a magnet.
- (2) The needle in a compass is a magnet.
- (3) Natural magnets are also called lodestones.
- (4) A freely suspended magnet will always rest in a north-east direction.

24. Ali cut a bar magnet into 3 pieces, A, B and C.

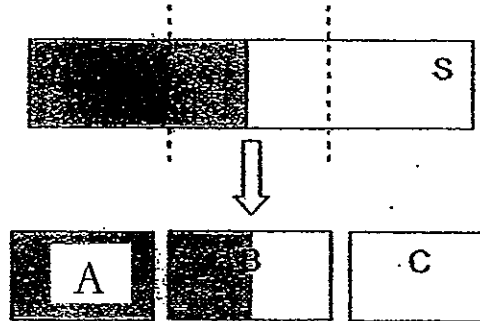

Which one of the following statements described what happened to parts A, B and C?

- (1) A, B and C lost their magnetism completely.
- (2) B remained as a magnet while A and C lost their magnetism completely.
- (3) A, B and C remained as magnets and had their own north and south poles.
- (4) A became the north pole and C became the south pole while B lost its magnetism completely.

25. A bar magnet was labelled as four equal parts, A, B, C and D. It was then lowered onto a table of thumbtacks. Four pupils predicted the number of thumbtacks that would be attracted to each part of the magnet.

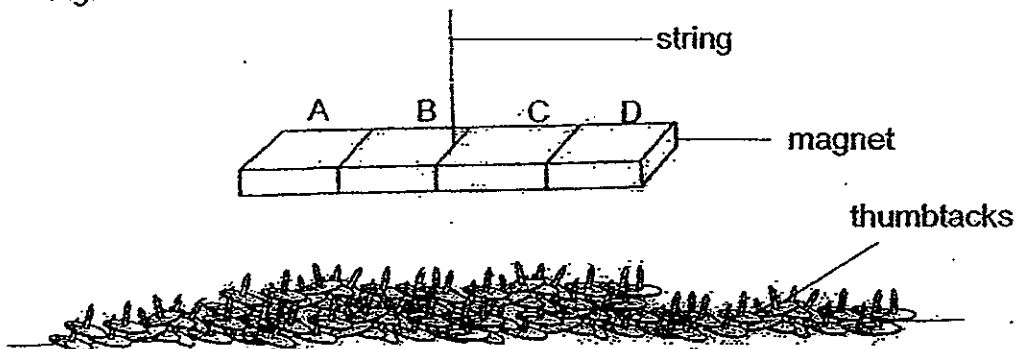

Which one of the following pupils had made a possible prediction based on the properties of magnets?

	Pupils	A	B	C	D
(1)	Abel	6	7	9	10
(2)	Barry	8	3	2	8
(3)	Carol	9	7	9	6
(4)	Danny	10	8	7	5

26. Ziyi set up an experiment as shown below. The magnetic force from the magnet caused the thumbtack to float in the air.

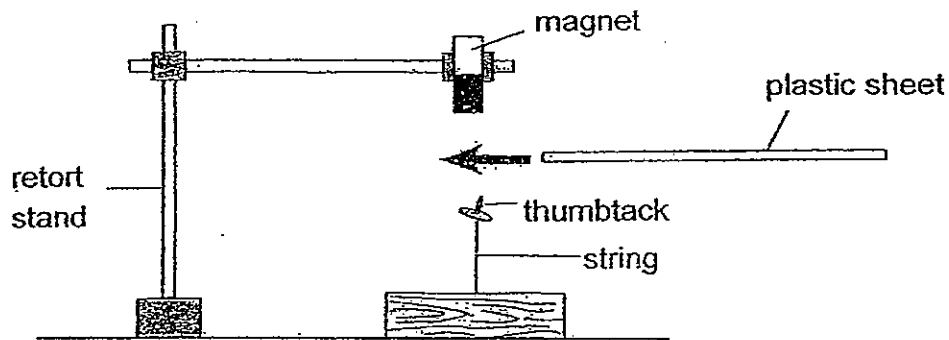

Ziyi then placed a plastic sheet between the magnet and thumbtack.

Which one of the following is the correct observation that she will make and its explanation?

- (1) The thumbtack will float as the plastic sheet can be magnetised.
- (2) The thumbtack will drop as the plastic sheet cannot be magnetised.
- (3) The thumbtack will float as magnetism can pass through the plastic sheet.
- (4) The thumbtack will drop as magnetism cannot pass through the plastic sheet.

27. The diagram below shows the attraction between three bar magnets when they are placed closed to one another. The poles of each magnet are represented by X, Y, P, Q, J and K.

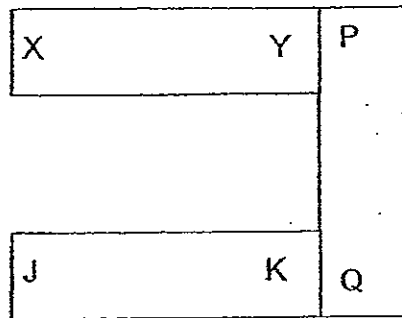

Which one of the following arrangements is a possible arrangement of the magnets when placed together?

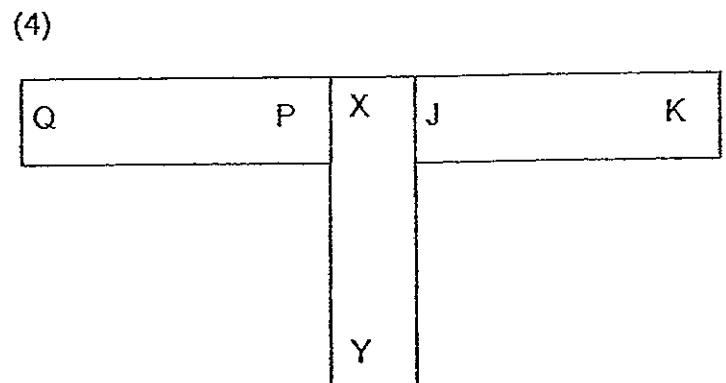
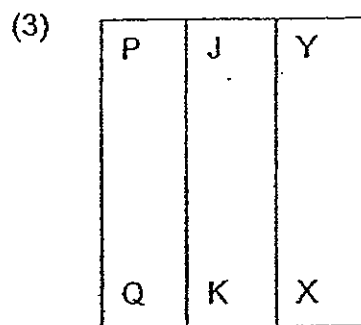
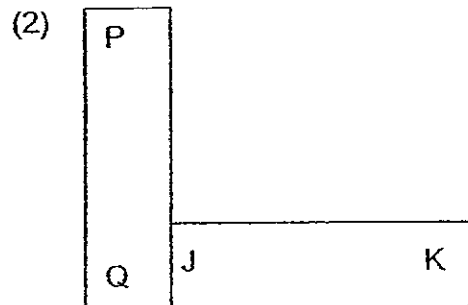
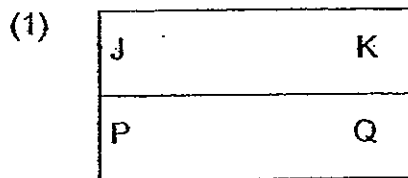

28. Lily conducted an experiment as shown below to turn some paper clips into temporary magnets.

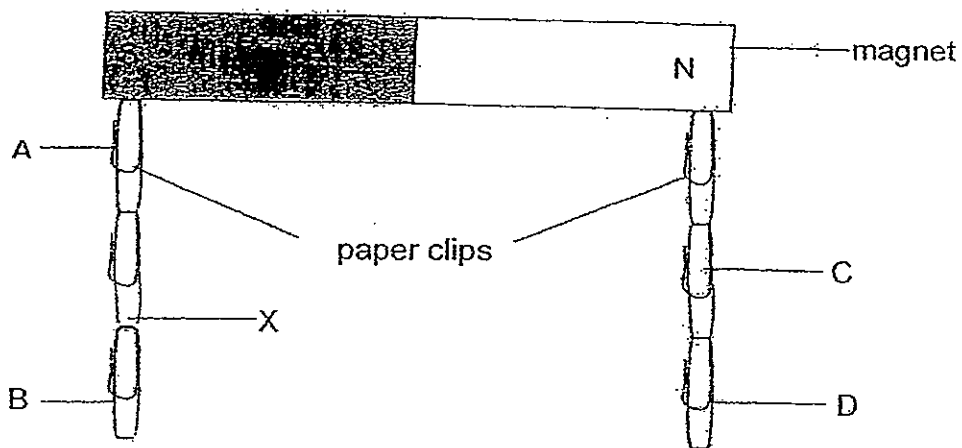

Lily tried to add another paper clip to paper clips B and D but no paper clip could be added on.

Which one of the following statements is true of the experiment above?

- (1) Point X is a north-seeking pole.
- (2) Paper clip D is not a magnetic material.
- (3) Paper clip A and C are of equal strength.
- (4) Paper clip B is a weaker magnet than paper clip C.

29. Zheng Ye wanted to make an iron bar into a temporary magnet using the "stroke" method. The iron bar had two labelled parts, A and B. He started stroking the iron bar from A to B with the south pole of a bar magnet and continued stroking in the same direction for twenty times as shown below.

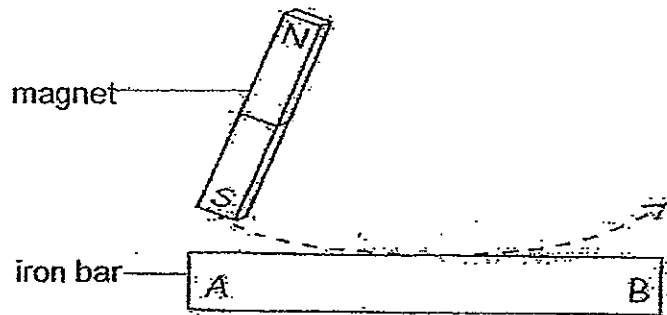

After the iron bar has been magnetised, which poles do A and B represent?

	A	B
(1)	North-pole	North-pole
(2)	North-pole	South-pole
(3)	South-pole	South-pole
(4)	South-pole	North-pole

30. Liz set up an experiment as shown below on a table.

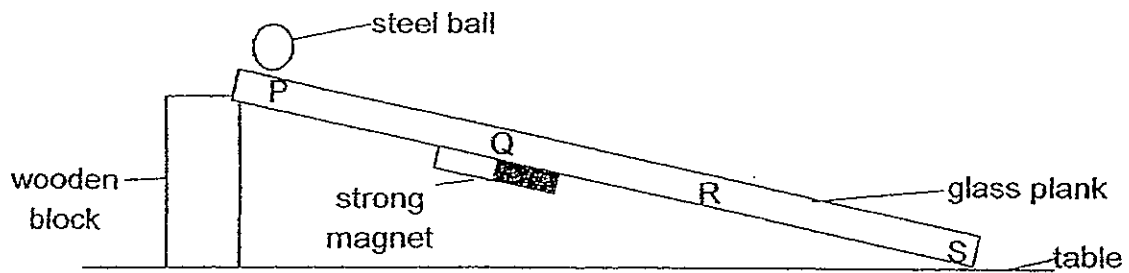

Liz rolled the steel ball down from point P, along the glass plank.

Which one of the following observations would Liz make?

- (1) The steel ball would not move and stay at point P.
- (2) The steel ball would roll to point Q and stop there.
- (3) The steel ball would roll to point R and stop there.
- (4) The steel ball will roll down from point P to S without stopping.



NANYANG PRIMARY SCHOOL
PRIMARY THREE SCIENCE
SEMESTRAL ASSESSMENT 2

2012

BOOKLET B

Date : 11 October 2012

Duration : 1 h 45 min

Name : _____ ()

Class: Primary 3 ()

Marks Scored:

Booklet A:		60
Booklet B :		40
Total :		100

Any query on marks awarded should be raised by 25 October 2012. We seek your understanding in this matter as any delay in the confirmation of marks will lead to delays in the generation of results.

Parent's signature:

**DO NOT OPEN THIS BOOKLET UNTIL YOU ARE TOLD TO DO SO.
FOLLOW ALL INSTRUCTIONS CAREFULLY.**

Booklet B consists of 14 printed pages including this cover page.

Section B (40 marks)

Write your answers to questions 31 to 44 in the spaces provided.
Marks will be deducted for misspelt key words.

31. Classify the four leaves below into two groups and give a suitable heading for each group. (3 m)



A



B



C

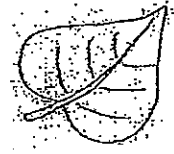

D

32. Joy conducted an experiment below. She placed both set ups A and B near a window. She wrapped the roots of plant B with a plastic bag before putting it into the beaker:

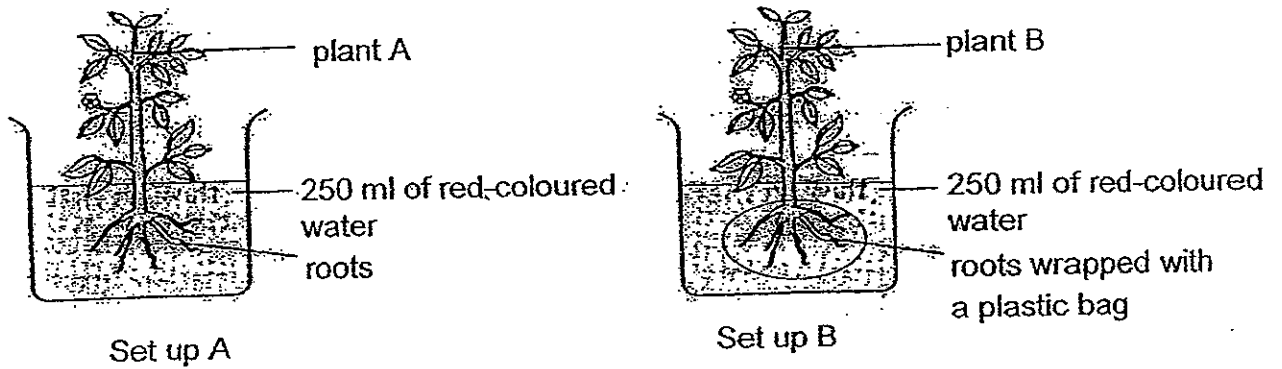

Joy wanted to show that roots absorbed water.

(a) Describe and explain what would happen to the leaves of plant A and B after a few days. (2 m)

Set Up	Observation	Explanation
A		
B		

(b) Describe another function of roots that is not shown in this experiment. (1 m)

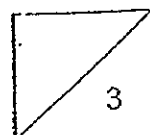

33. Johnson placed organism X in an opened container filled only with water. He placed it in a bright area. He then prepared another container of water with organism X and placed it in a dark area.

After a few weeks, he noticed that organism X had grown bigger only in the container which was placed in the bright area.

(a) Give a specific example of what organism X could be. (1 m)

(b) Explain how organism X was able to grow bigger when placed in the bright area. (1 m)

34. Ali placed a moistened bread and a dry bread in a dark corner of his room. He noticed that one of the breads had a greenish-brown organism living on it after a few weeks.

(a) State which bread, dry or moistened, will most likely have the greenish brown organism growing on it. (1 m)

(b) Explain your answer in (a). (1 m)

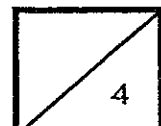

35. The table below shows the characteristics of four plants, A, B, C and D. A tick (✓) indicates that the organism has that particular characteristic.

Plant	bears flowers	grows only on land	grows only in water
A			✓
B	✓		✓
C	✓	✓	
D		✓	

Fill in the boxes below with suitable questions for the flow chart. (3 m)

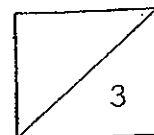
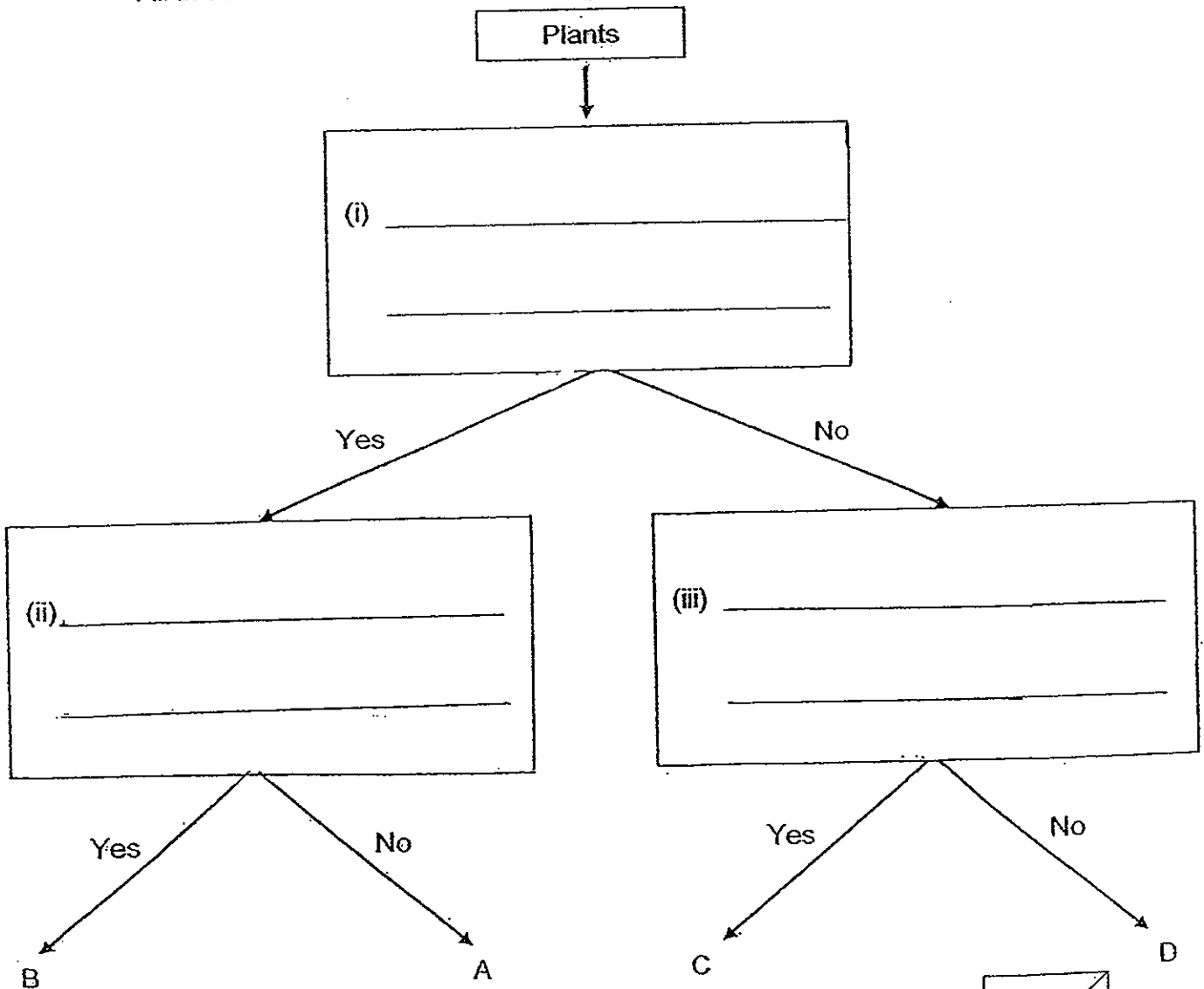

36. During a school trip, Ali came across a Venus flytrap. The plant shut its 'trap' when an insect crawled into it. His teacher then explained that the plant would release a liquid that would digest the trapped insect.

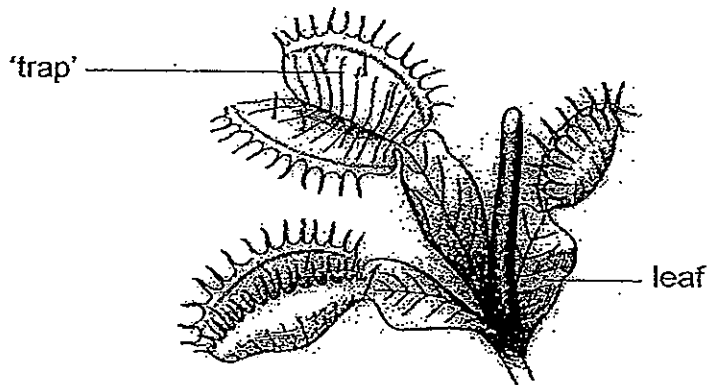

- (a) What characteristic of living things did the Venus flytrap display when it shut its trap? (1 m)

Ali said that the Venus flytrap did not need sunlight to survive. He was told that his statement is wrong.

- (b) Based on the diagram of the plant above, explain why he is wrong. (2 m)

37. The chart below shows how some plants can be classified.

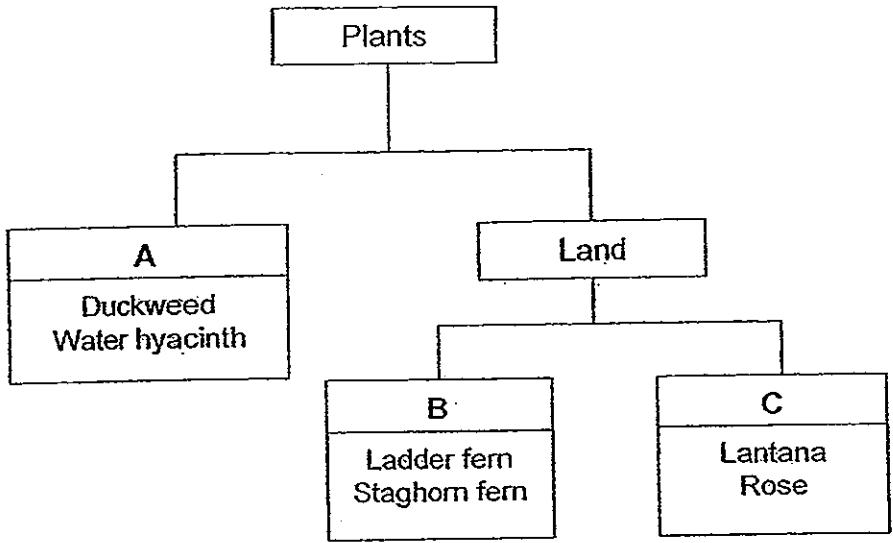

(a) Give a suitable heading for A, B and C. (3 m)

A : _____

B : _____

C : _____

(b) Cindy classified 'yeast' under group C. Explain why her classification was incorrect. (1 m)

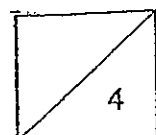

38. Study the flow chart below.

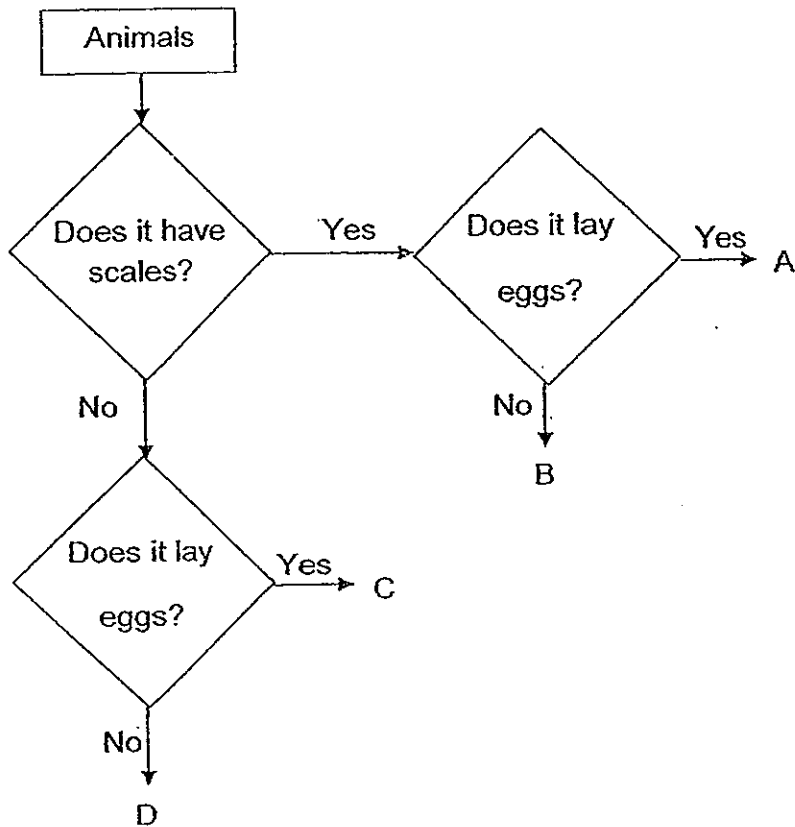

(a) Describe the characteristics of animal A. (1 m)

(b) Give an example of animal B. (1 m)

(c) State a similar characteristic for animals C and D. (1 m)

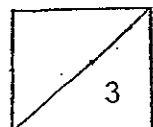

39. The diagram below shows an animal with a segmented body that breathes through breathing holes.

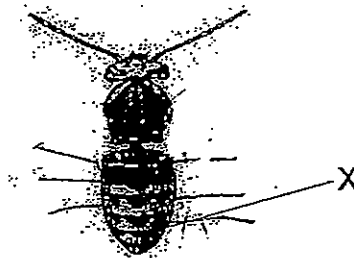

- (a) Draw all the legs of the animal on the diagram above. (2 m)
- (b) Name the part labelled X. (1 m)
-

40. Study the flow chart below.

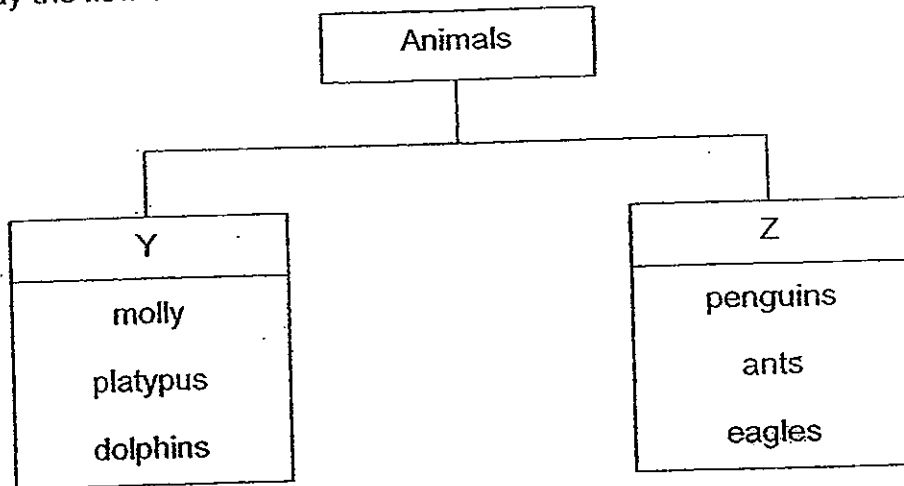

An animal from Group Y has been wrongly classified.

- (a) Which of the animals in group Y has been wrongly classified? (1 m)
-

- (b) How are the animals above classified? (1 m)
-

41. The diagrams below show a bird and a cow.

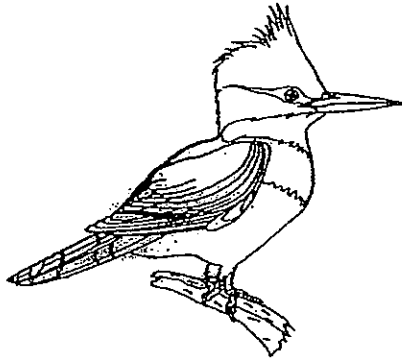

bird

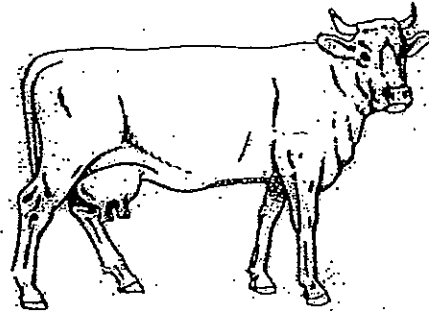

cow

Compare the outer covering of the two animals.

- (a) Name the outer covering of each animal. (1 m)

Bird: _____

Cow: _____

- (b) State one similar function of both types of outer coverings. (1 m)

- (c) State one difference in function between the outer covering of a bird and the outer covering of the cow. (1 m)

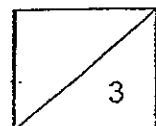

42. Jessie conducted an experiment to study the hardness of four different materials, A, B, C and D. She used the sharp ends of a plastic rod, a wooden rod, metal rod and glass rod to scratch each of these materials.

She recorded her observations in the table below. A tick (✓) indicates the presence of scratch marks observed on the materials.

Rod used to scratch material	Presence of scratch marks on materials			
	A	B	C	D
Plastic	✓	✓	✓	
Wood	✓	✓	✓	
Metal			✓	
Glass		✓	✓	

Arrange the material from the least hard to the hardest. (2 m)

Least hard $\xrightarrow{\hspace{10em}}$ hardest

--	--	--	--

43. Connie set up an experiment as shown below. She hung four bar magnets of the same size using different lengths of strings from a wooden block.

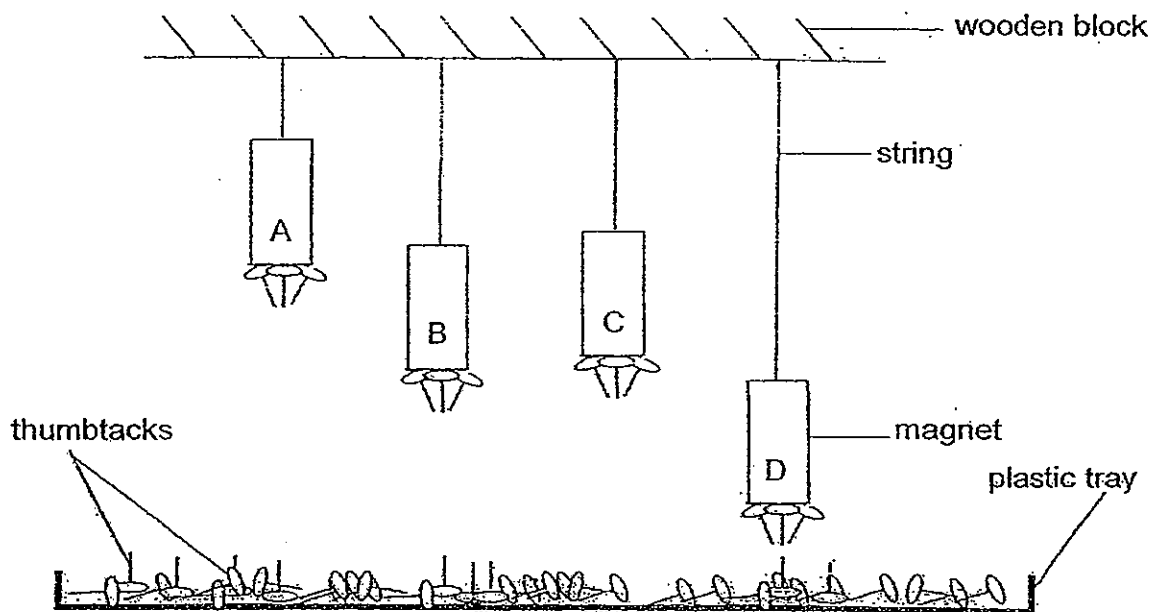

(i) Based on the results shown ^{above} ~~below~~, which magnet is the strongest? (1 m)

(ii) Explain your answer to part (i). (2 m)

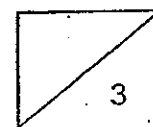

44. Raja set up the circuit below to turn an iron nail into an electromagnet.

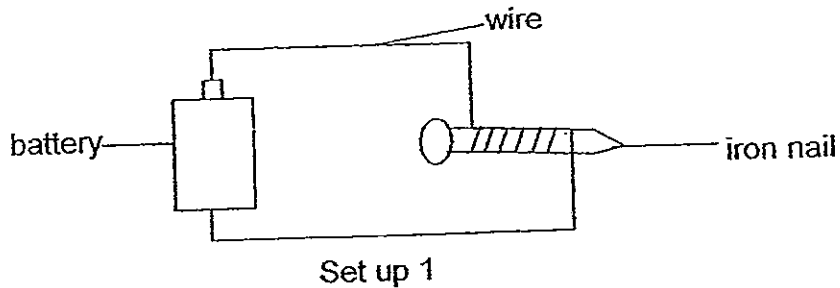

(a) State the property of the iron nail that allows it to be turned into an electromagnet. (1m)

Raja was told that he could change the number of batteries used in his circuit to produce an electromagnet with different magnetic strengths. He then used the iron nail which had become an electromagnet to attract some paper clips. He repeated this step after changing the number of batteries in his circuit and recording the number of paper clips attracted.

The table below showed the number of paper clips which the electromagnet attracted.

Number of batteries used	Number of paper clips attracted
1	3
3	(b) _____
5	6

Based on the results above, how many paper clips would most likely be attracted by the electromagnet when 3 batteries were used in his circuit?

(b) Fill your answer in the empty box in the table above. (1 m)

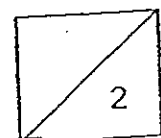

Study the bar graph below. Raja varied the number of coils around the iron nail in set up 1 to test the strength of the electromagnet.

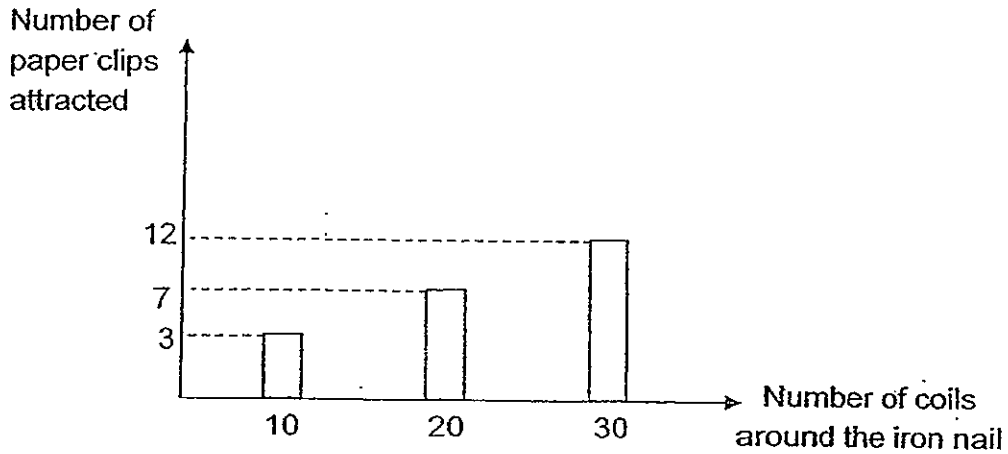

- (c) How did the number of coils around the iron nail affect the strength of the electromagnet? (1 m)

The diagram below shows a crane lifting a car using an electromagnet.

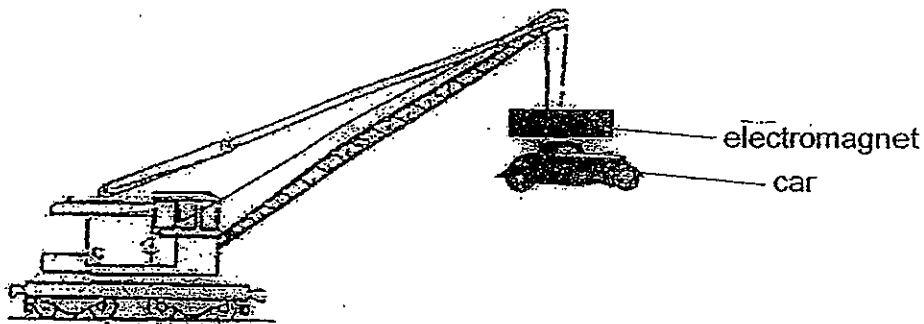

After lifting the car, the crane would lower it to another location.

- (d) What needs to be done to allow the electromagnet to drop the car? (1 m)

~The End~

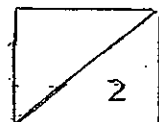

ANSWER SHEET

EXAM PAPER 2012

SCHOOL : NANYANG PRIMARY SCHOOL

SUBJECT : PRIMARY 3 - SCIENCE

TERM : SA 2

Booklet A

Q1	Q2	Q3	Q4	Q5	Q6	Q7	Q8	Q9	Q10	Q11	Q12	Q13	Q14	Q15	Q16
3	1	2	2	2	3	1	2	3	3	4	1	3	4	2	4

Q17	Q18	Q19	Q20	Q21	Q22	Q23	Q24	Q25	Q26	Q27	Q28	Q29	Q30
1	4	4	2	4	1	4	3	2	3	1	4	4	2

Booklet B

31.

Smooth/entire edge	Lobbed edge
A, D	B, C

32. a)

Set up	Observation	Explanation
A	It will have red-coloured leaves.	It absorbed the water into its roots and transported it to its leaves.
B	It will die.	The roots could not absorb the water to make food.

b) The roots hold the plant firmly to the ground.

33. a) Hydrilla, water lily, money plant.

b) Organism X could make its own food by using sunlight.

34. a) Moistened.

b) It needs moisture/water to grow.

35. i) Does it grow only in water?

ii) Does it bear flowers?

iii) Does it bear flowers?

36. a) It responded to changes in the surroundings.

b) It has leaves thus it needs sunlight to make food.

37. a) A: Aquatic plants B: Reproduce by spores C: Reproduce by seeds
 b) Yeast is not a plant and does not reproduce by seeds.
38. a) Animal A lays eggs and have scales.
 b) Guppy/ Molly.
 c) Animal C and D do not have scales.
39. a) (all 6 legs should be drawn connected to the thorax only)
 b) Abdomen.
40. a) Platypus.
 b) They are classified according to whether they reproduce by giving birth to their young alive or by laying eggs.
41. a) Bird: feathers Cow: hair
 b) It keeps the animal warm.
 c) Feathers help the bird to fly but hair does not.
42. Least hard $\xrightarrow{\hspace{10em}}$ hardest
- | | | | |
|---|---|---|---|
| C | B | A | D |
|---|---|---|---|
43. i) Magnet A
 ii) It is able to attract the same number of paper clips as the other magnets even though it is the furthest away from the plastic tray.
44. a) It must be a magnetic material.
 b) 5
 c) The greater the number of coils, the stronger the magnet will be.
 d) Switch off the electric supply.