



Anglo-Chinese School (Primary)

END-OF-YEAR EXAMINATION 2013
MATHEMATICS
BOOKLET A
PRIMARY FOUR

Name: _____ () Class: Primary 4 ____

Date: 25 October 2013

Duration of Booklet A & B: 1h 45min

INSTRUCTIONS TO CANDIDATES

1. This question paper consists of 8 printed pages.
2. Do not turn this page until you are told to do so.
3. Follow all instructions carefully.
4. Shade your answer on the Optical Answer Sheet (OAS) provided.



SECTION A - Multiple Choice Questions (15 Questions x 2 Marks)

Questions 1 to 15 carry 2 marks each.

For each question, four options are given. One of them is the correct answer. Make your choice (1, 2, 3 or 4) and shade the correct oval (1, 2, 3 or 4) on the Optical Answer Sheet (OAS).

1. In which of the following numbers does the digit 8 stand for 800?

(1) 5 208

(2) 8 345

(3) 4 983

(4) 9 857

2. In which of the following are the numbers arranged from the smallest to the greatest?

(smallest)

(greatest)

(1) 3 608 , 3 860 , 3 068

(2) 3 860 , 3 608 , 3 068

(3) 3 068 , 3 608 , 3 860

(4) 3 860 , 3 068 , 3 608

3. 36 is a common multiple of _____.

(1) 2 and 5

(2) 3 and 4

(3) 6 and 8

(4) 7 and 12

4. How many one-quarters are there in 2 wholes?

(1) $1\frac{1}{2}$

(2) $2\frac{1}{4}$

(3) 8

(4) 4

5.

$$9\frac{7}{11} = \frac{\boxed{?}}{11}$$

What is the missing number in the box?

(1) 63

(2) 74

(3) 99

(4) 106

6. Jeff has 24 more stamps than Karev. If Jeff gave away $\frac{1}{6}$ of his stamps, he would have 35 stamps left. How many stamps did Karev have?

(1) 11

(2) 18

(3) 42

(4) 66

7. In which of the following numbers does the digit 4 stand for 4 tenths?

(1) 167.42

(2) 184.39

(3) 235.64

(4) 249.63

8. Which of the following figures can be tessellated?

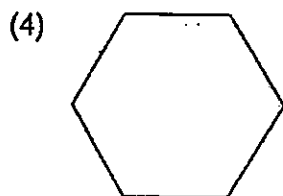
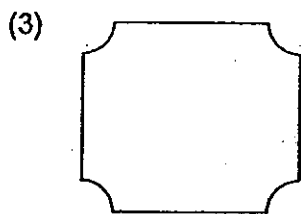
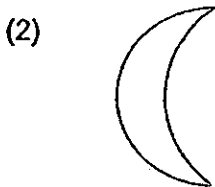
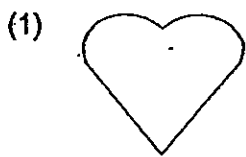

9. 0.45 is the same as _____.

(1) $4 + \frac{5}{10}$

(2) $\frac{4}{10} + \frac{5}{10}$

(3) $\frac{4}{100} + \frac{5}{100}$

(4) $\frac{4}{10} + \frac{5}{100}$

10. Find the sum of 0.7 and 234.87.

Round off the answer to the nearest tenth

(1) 235.0

(2) 235.5

(3) 235.6

(4) 236.0

11. In the figure below, AB is a straight line. Which one of the following is the best estimate of $\angle x$?

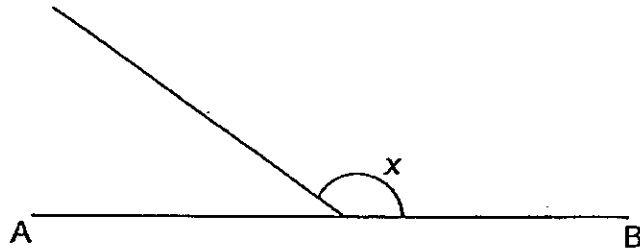

- (1) 35°
(2) 79°
(3) 155°
(4) 180°
12. Alex left his home at 10 35 for the mall. He boarded the bus 15 minutes later and reached the mall at 11 22. What was the duration of his bus journey?
- (1) 32 minutes
(2) 47 minutes
(3) 72 minutes
(4) 87 minutes

13. Sharon has 210 oranges. She packs the oranges into boxes. Each ^{box} bag contains 9 oranges. What is the maximum number of boxes that she can pack?

(1) 21

(2) 22

(3) 23

(4) 24

14. Which one of the following figures has perpendicular lines?

(1)



(2)

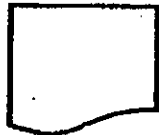

(3)



(4)



15. The figure shown below, not drawn to scale, is made up of square ABCD and rectangle WXYZ. The length CD is 24 cm and the length XY is 5 cm. The area of rectangle WXYZ is 180 cm^2 . Find the perimeter of the figure below.

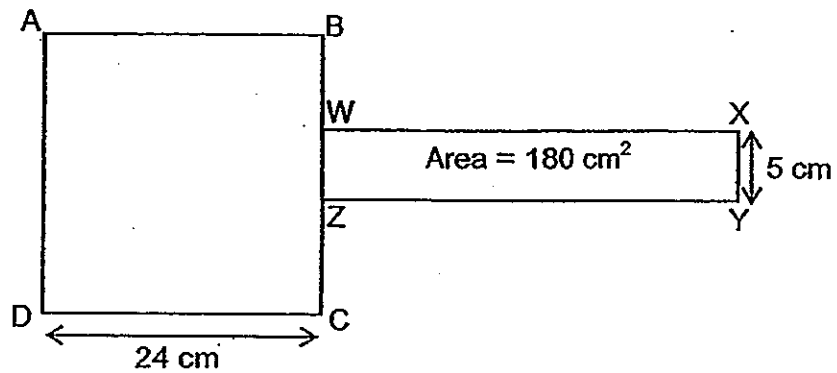

- (1) 168 cm
- (2) 178 cm
- (3) 276 cm
- (4) 756 cm



Anglo-Chinese School (Primary)

END-OF-YEAR EXAMINATION 2013
MATHEMATICS
BOOKLET B
PRIMARY FOUR

Name: _____ () Class: Primary 4 _____

Date: 25 October 2013

Duration of Booklet A & B: 1h 45min

Parent's/Guardian's signature

INSTRUCTIONS TO CANDIDATES

1. This question paper consists of 16 printed pages.
2. Do not turn this page until you are told to do so.
3. Follow all instructions carefully.
4. Answer all questions.

Marking Scheme		
A. Multiple-Choice Questions	30	
B. Short Answers	40	
C. Problem Sums	30	
Total Marks	100	

SECTION B - Short Answers (20 Questions x 2 Marks)

Questions 16 to 35 carry 2 marks each. Show all workings clearly.

Write your answer in the space provided. Give your answers in the units stated and in its simplest form whenever possible.

16. Write $\frac{53}{8}$ as a mixed number in its simplest form.

Answer : _____

17. Write the missing number in the number pattern below.

5893 , 5548 , _____ , 4858 , 4513

Answer : _____

18. Two factors of 87 are 1 and 87. What are the other factors of 87?

Answer : _____ and _____

19. In the figure shown below, WXYZ is a rectangle. Find the value of $\angle a$.

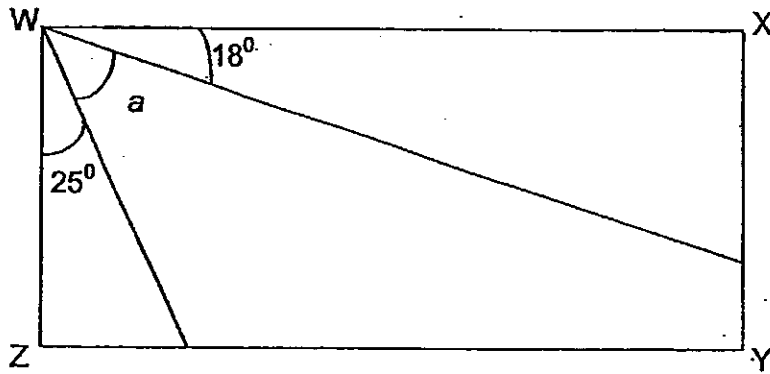

Answer : _____

20. In the figure below, rectangle ABCD is made up of 6 unit squares. What fraction of rectangle ABCD is unshaded?

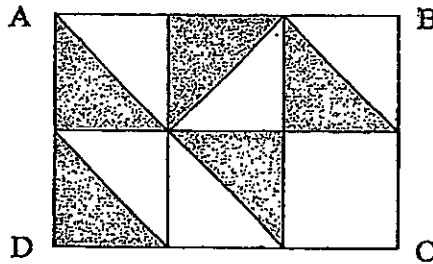

Answer : _____

21. $3.65 = \frac{365}{\boxed{?}}$

What is the missing number in the box?

Answer : _____

22. The cost of a laptop is \$975. Michael bought 12 such laptops. How much money would he have left if he paid using twelve \$1000 notes?

Answer : \$ _____

23. Find the value of 16.97×8 .

Answer : _____

24. Mary is facing the market. If she turns _____^o anti-clockwise, she will face the park.

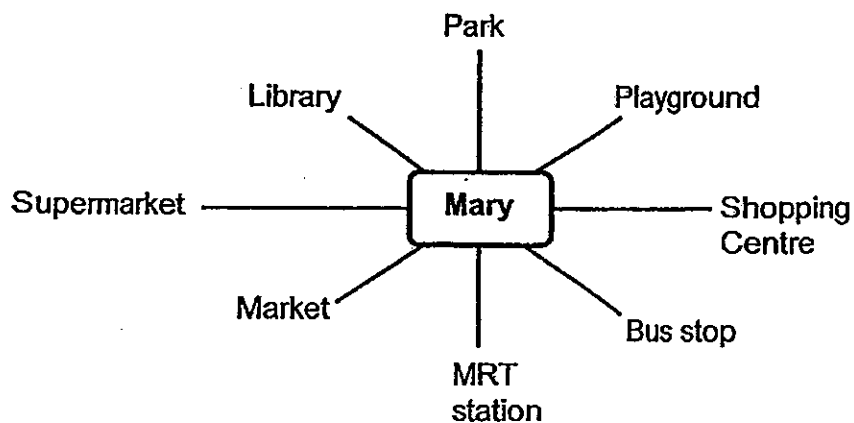

Answer : _____^o

25. A file and a notebook cost \$3.70. Danny bought 4 such files and 5 notebooks for \$16.40. How much did each notebook cost?

Answer : \$ _____

26. $8.56 - 6.78 =$ _____.

Answer : _____

27. The figure below, not drawn to scale, is made up of 3 identical squares. The length of AB is 18 cm. Find the area of the figure given.

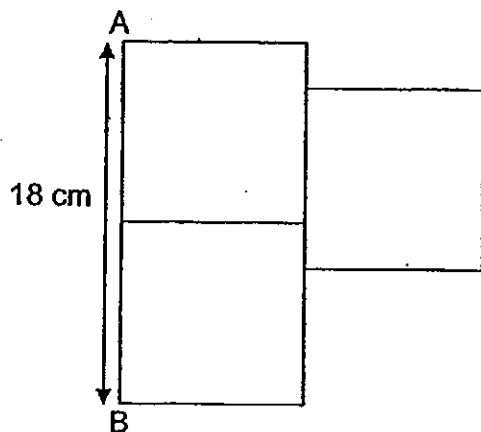

Answer : _____ cm^2

Study the graph below carefully and answer questions 28 and 29. The graph below shows the number of pupils who visited the dentist from Monday to Friday.

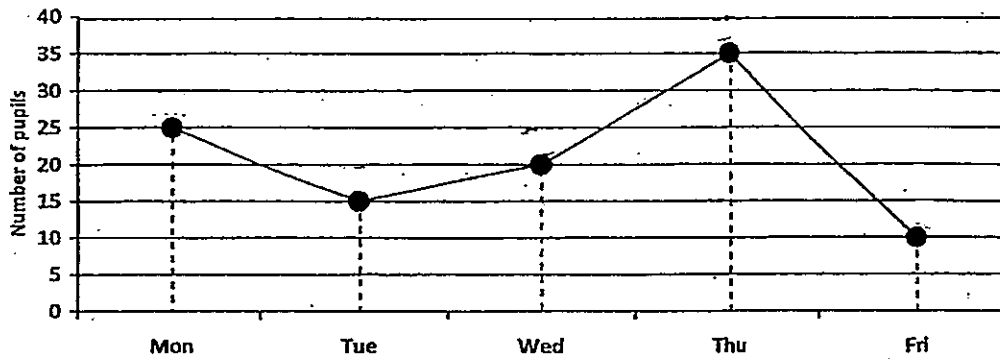

28. On which day was the number of pupils who visited the dentist $\frac{1}{3}$ of the total number of pupils who visited the dentist from Monday to Friday?

Answer : _____

29. How many pupils visited the dentist on both Monday and Tuesday?

Answer : _____

30. A tank is $\frac{2}{9}$ full when it is filled with 12 ℓ of water. How much water will there be when the tank is $\frac{1}{2}$ full?

Answer : _____ ℓ

31. Jasmine takes 1 h 45 min to sew a dress. If Jasmine finished sewing at 12 35, at what time did she start sewing the dress?
Give your answer in the 24-hour clock format.

Answer : _____

32. A pail containing 9 identical metal blocks weighs 12.5 kg. If each metal block weighs 1.3 kg, find the mass of the pail.

Answer : _____ kg

33. Complete the symmetric figure using the dotted line AB as the line of symmetry.

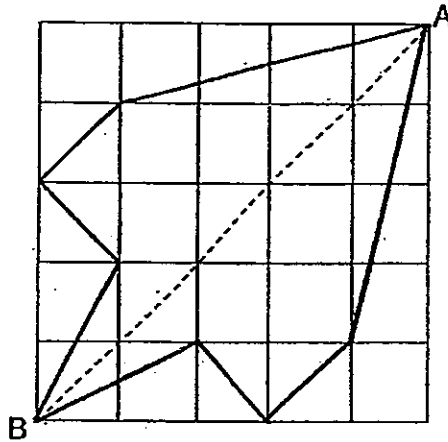

34. In the figure below, the length of AB is equal to the length of CD. The length of EF is equal to the length of FG. Find the area of the figure below.

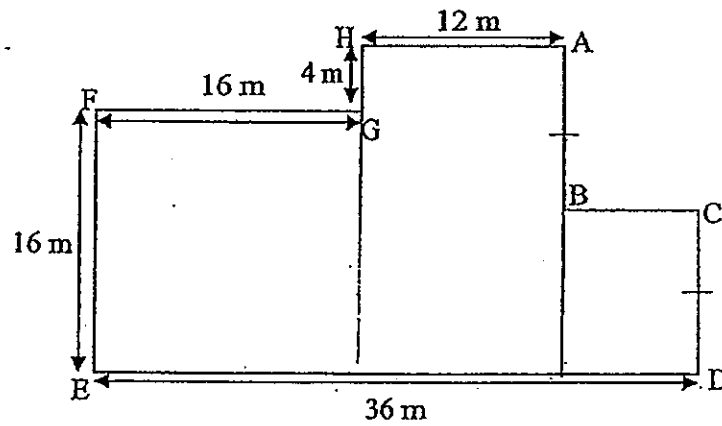

Answer : _____ m²

35. Round off the sum of 4.56 and 6.95 to the nearest whole number.

Answer : _____

SECTION C - Problem Sums (30 Marks)

For each question from 36 to 43, show your working and mathematical statements clearly in the space below each question. Write your answer in the answer space provided. Give your answers in the units stated and in its simplest form whenever possible. Marks awarded are shown in the brackets [].

36. Jenny was reading a storybook. She read $\frac{1}{4}$ of the book on Saturday and read $\frac{7}{12}$ of it on Sunday.

a) What fraction of the storybook was not read? (Give your answer in its simplest form.

b) If she had 36 more pages to read, how many pages did the storybook contain?

Answer: (a) _____ [1]

(b) _____ [2]

37. Vidya had some money. She wanted to buy 12 muffins but she was short of \$4.55. Instead, she bought 8 muffins and had \$1.25 left. How much money did she have at first?

Answer: _____ [3]

38. Raymond and Jessica have a total of 748 stickers. Sarah and Jessica have a total of 935 stickers while Raymond and Sarah have a total of 1177 stickers. Frances has 15 fewer stickers than Raymond. How many stickers does Frances have?

Answer: _____ [4]

39. Mrs Fang sells two types of cakes. The chocolate cake costs \$3.50 each and the marble cake costs \$4.10 each. If she sold 100 cakes in total and collected \$392. how many chocolate cakes did she sell?

Answer: _____ [4]

40. $\frac{3}{11}$ of a class of pupils like archery, $\frac{1}{4}$ of the remaining pupils like bowling and the rest like chess. There are 2 more pupils who like chess compared to archery.

a) How many pupils like bowling?

b) How many pupils are there in the class altogether?

Answer: (a) _____ [2]

(b) _____ [2]

41. The figure below, not drawn to scale, is made up of Square A and Rectangle B. The area of Square A is 64 cm^2 . If the total area of Square A and Rectangle B is 288 cm^2 , what is the perimeter of the figure?

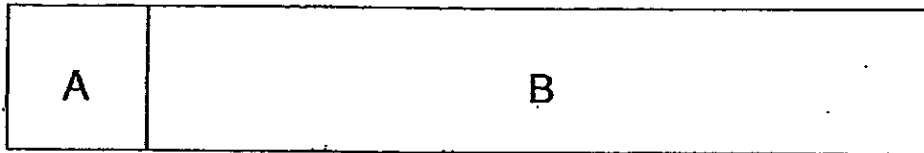

Answer: _____ [4]

42. Maggie took 40 min to walk from her home to the shopping centre. She then spent the next 1 h 30min at the cinema watching a movie. After that, she left the shopping centre and arrived home at 17 50.

If her return trip home took 15 min longer than her walk to the shopping centre, at what time did she leave her home for the shopping centre?

Answer: _____ [4]

43. Bag A contains 26.5 kg more peanuts than Bag B. After 4.55 kg of peanuts were removed from Bag B and placed into Bag A, the mass of Bag A was five times the mass of Bag B. What was the mass of peanuts in Bag A at first?

Answer: _____ [4]

END – OF – PAPER

ANSWER SHEET

EXAM PAPER 2013

SCHOOL : ANGLO-CHINESE PRIMARY SCHOOL

LEVEL : PRIMARY 4

SUBJECT : MATHEMATICS

TERM : SA2

Booklet A

Q1	Q2	Q3	Q4	Q5	Q6	Q7	Q8	Q9	Q10	Q11	Q12	Q13	Q14	Q15
4	3	2	3	4	2	1	4	4	3	3	1	3	2	1

16. $6\frac{5}{8}$

17. 5203

18. 3 and 29

19. 47

20. $\frac{7}{12}$

21. 100

22. 300

23. 135.76

24. 225

25. 1.60

26. 1.78

27. 243

28. Thursday

29. 40 pupils

30. 27

31. 10 50

32. 0.8

33.

34. 576

35. 12

36a) $1 - \frac{1}{4} - \frac{7}{12} = \frac{2}{12} = \frac{1}{6}$

b) $\frac{36}{2} = 18$

$18 \times 12 = 216$

37. $12 - 8 = 4$

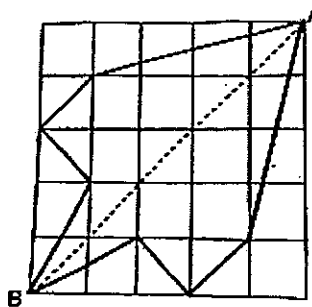

$$4.55+1.25=5.80$$

$$5.80/4=1.45$$

$$1.45 \times 8 = 11.60$$

$$11.60+1.25=12.85$$

$$38. 117+748=1925$$

$$1925-935=990$$

$$990/2=445$$

$$495-15=480$$

$$39. C+M = 100$$

$$3.5C+4.1M=392$$

$$3.5C+3.5M=350$$

$$0.6M=42$$

$$M = 70$$

$$100-70=30$$

$$40. 1/4=2/8$$

$$6u-3u=3u$$

$$3u=12$$

$$U=4$$

$$a) 4 \times 2 = 8$$

$$b) 4 \times 11 = 44$$

$$41. 64/8=8$$

$$288-64=224$$

$$224/8=28$$

$$28+8=36$$

$$36+8=44$$

$$44 \times 2 = 88$$

$$42. 40+15=55$$

$$40-25=15$$

Answer: 14 45

$$43. 26.5+4.55=35.6$$

$$35.6/4=8.9$$

$$26.5+8.9+4.55=39.95 \text{ kg}$$