



Rosyth School
Second Semestral Examination for 2012
SCIENCE
Primary 4

Name: _____

Class: Pr 4 - _____ Register No. _____ Duration: 1 h 45 min

Date: 24 October 2012 Parent's Signature: _____

Booklet A

Instructions to Pupils:

1. Do not open the booklets until you are told to do so.
2. Follow all instructions carefully.
3. This paper consists of 2 booklets, Booklet A and Booklet B.
4. For questions 1 to 30 in Booklet A, shade the correct ovals on the Optical Answer Sheet (OAS) provided using a 2B pencil.
5. For questions 31 to 44, write your answers in the spaces given in Booklet B.

* This booklet consists of 17 pages.

This paper is not to be reproduced in part or whole without the permission of the Principal.

3. The diagram below shows the growth of a young plant with two missing stages C and D.

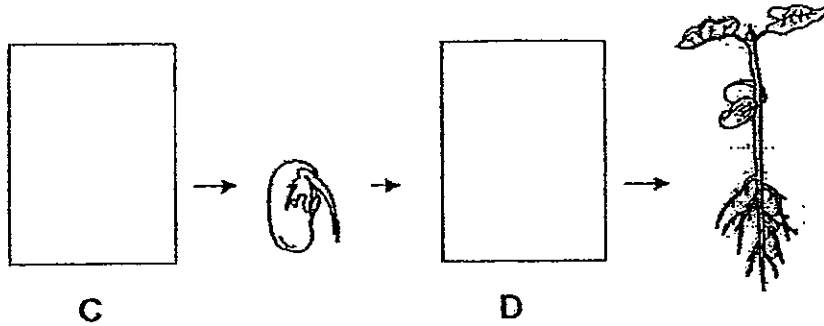

Which one of the following shows the correct stages for C and D?

	C	D
(1)		
(2)		
(3)		
(4)		

4. Mealworms go through moulting in their life cycle. Why do they go through moulting?

- (1) To mate with each other.
- (2) To stop eating and become inactive.
- (3) To shed their skin several times to grow bigger.
- (4) To reproduce more young in order to ensure continuity of species.

5. Siti drew four life cycles.

(A)

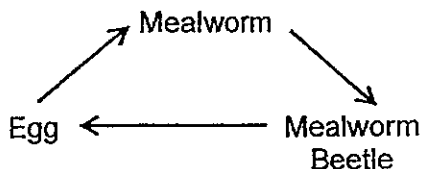

(B)

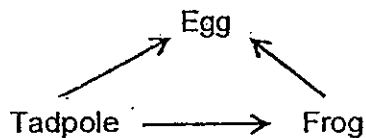

(C)

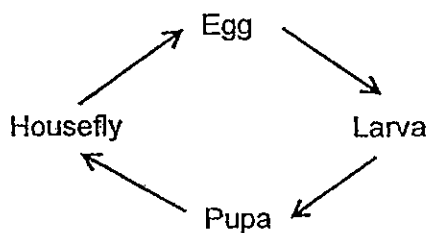

(D)

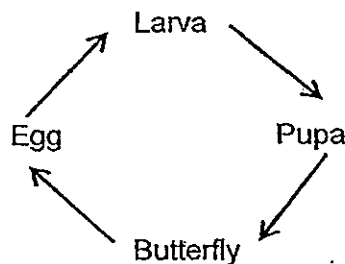

Which of the life cycles are correct?

- (1) A and B only
- (3) B and D only

- (2) C and D only
- (4) B, C and D only

6. Which of the following graphs shows the change in height as a seed grows into an adult plant?

(1)

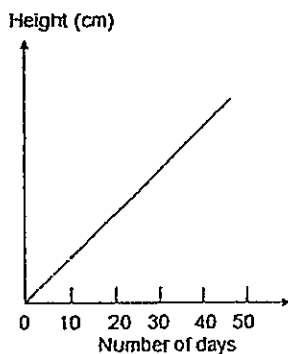

(2)

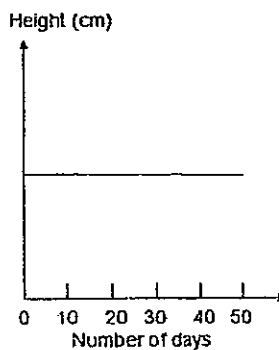

(3)

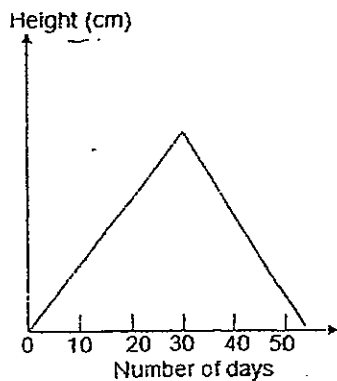

(4)

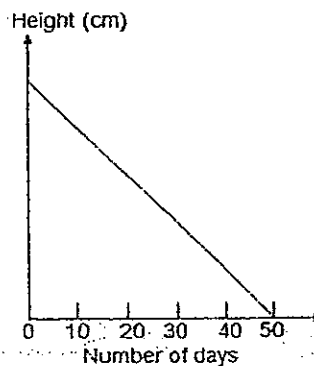

7. The table below shows the comparisons between the life cycles of a frog and a cockroach.

		Frog	Cockroach
A	Young	Does not resemble the adult	Resembles the adult
B	Number of stages	4 stage	3 stage
C	Method of reproduction	Lays eggs	Lays eggs
D	Number of legs at adult stage	Four legs	Six legs

Which of the above comparisons are correct?

- (1) A and C only (2) B and D only
 (3) A, B and D only (4) A, C and D only
8. Which one of the following properties is true for both oxygen and a pen?
- (1) They have mass.
 (2) They have fixed shapes.
 (3) They have fixed volumes.
 (4) They can be compressed.

9. ° Terence placed a ball of plasticine into a container of water. He noticed that the water level rose to the 180 cm^3 mark.

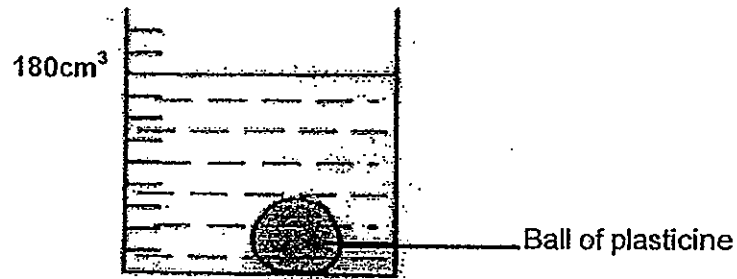

He then took the ball of plasticine out of the water, divided it into two pieces and lowered them slowly into the water again.

Which of the following diagrams shows the correct water level in the container?

(1)

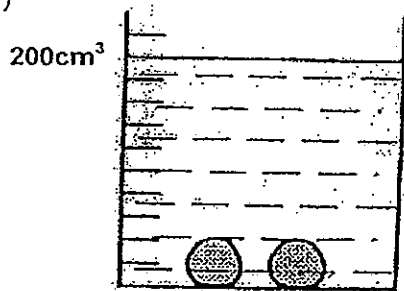

(2)

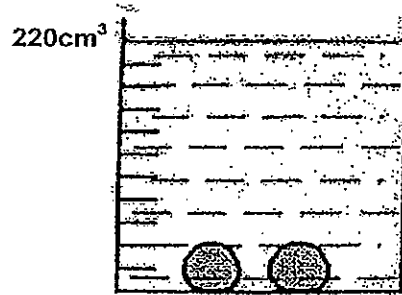

(3)

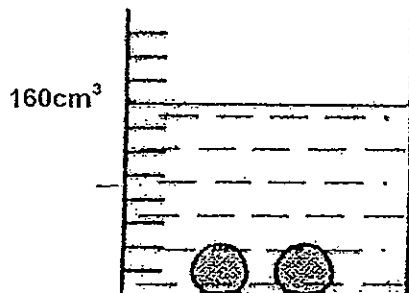

(4)

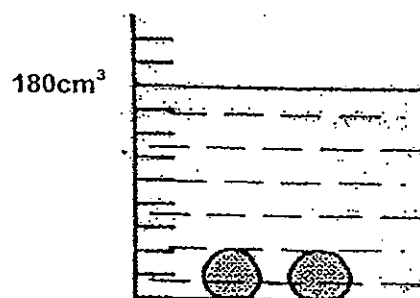

10. Ahmad pumped some air into a soccer ball using a bicycle pump. The graph below shows the change in volume of the ball after it was pumped six times.

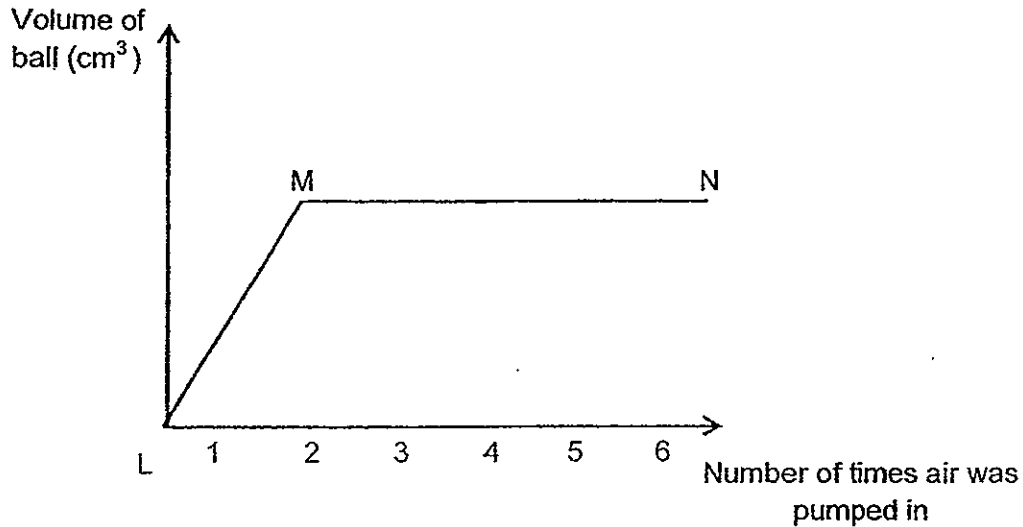

What does Part MN of the graph represent?

- (1) The soccer ball had burst.
 - (2) The air in the soccer ball had escaped.
 - (3) The air in the soccer ball was compressed.
 - (4) The soccer ball continued to increase in size.
11. The diagram below shows a flowering plant.

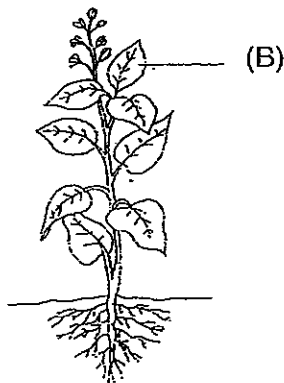

What happens to the plant when all the parts labelled 'B' are removed?

- (1) It is not able to make food.
- (2) It can no longer grow upright.
- (3) It cannot bear flowers and fruits.
- (4) It will not be able to absorb water and mineral salts.

12. Which of the following statement best describes the way the plant grows as shown in the diagram below?

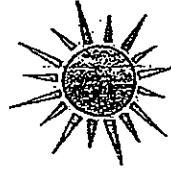
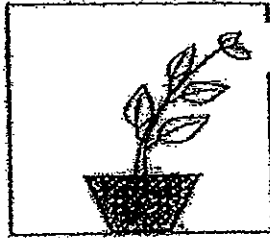

- (1) The plant has a weak stem.
 - (2) The plant needs more air to grow.
 - (3) The plant grows towards the sunlight.
 - (4) The plant has no more space to grow upwards.
13. Cindy wanted to grow her green bean plant in a pot. She accidentally broke part of the roots as shown below. What will happen to the plant after a week?



- (1) The plant will die.
 - (2) The plant continues to grow.
 - (3) The other roots will also drop off from the plant.
 - (4) The leaves from the plant will dry up and fall off.
14. Saliva is known to help in the process of digestion. Which of the following statements about saliva is correct?
- (1) It absorbs water and mineral salts
 - (2) It helps to push down the food into our stomach.
 - (3) It helps to make the food moist so that it can be swallowed.
 - (4) It absorbs the digested food and transports it to our bloodstream.

15. Which of the following objects can be bent easily without breaking?

- (1) A marble
- (2) A plastic spoon



- (3) A towel
- (4) A metal ruler

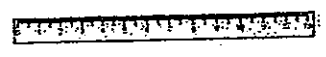

16. James carried out an experiment using four different materials (Materials A, B, C and D) of equal lengths. He placed one corner of each material into an empty dish and poured some coloured water into the dish.

The diagram below shows what he observed after pouring the coloured water into the dish.

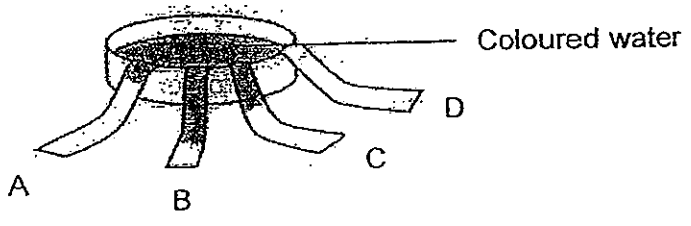

Which material is suitable for making a raincoat?

- (1) A
- (2) B
- (3) C
- (4) D

17. In which of the following will the two magnets attract each other?

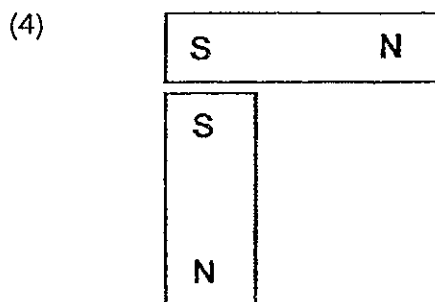
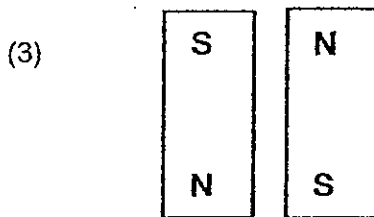
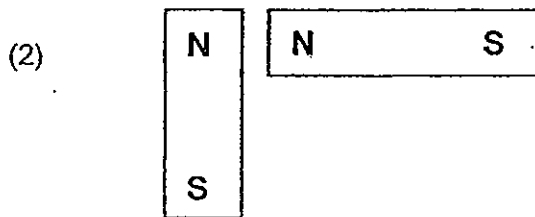
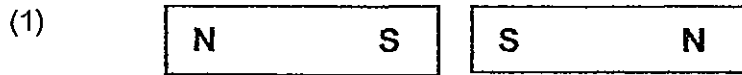

18. Which one of the following objects will be attracted to a magnet?

(1)



plastic bag

(2)



paper

(3)



stainless steel spoon

(4)

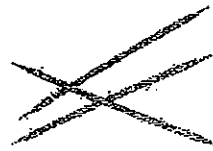

toothpicks

19. Study the flowchart carefully.

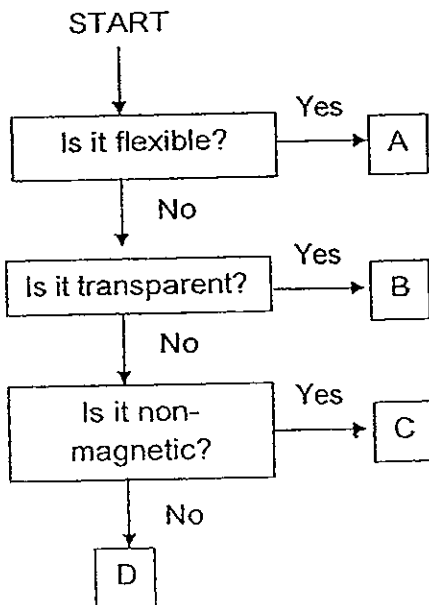

Based on the flowchart, where will a ten-cent coin be placed?

- (1) A
- (3) C

- (2) B
- (4) D

20. The diagram below shows what happens when both ends of X are brought near Y.

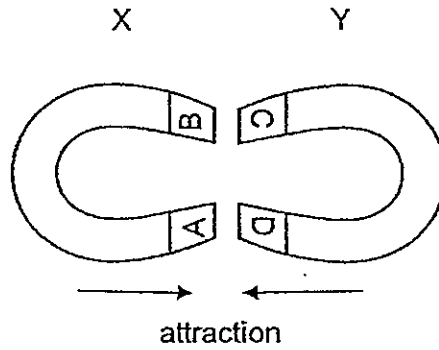

The diagram below shows what happens when Y was turned over.

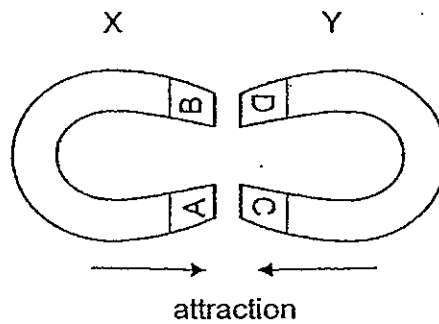

Which of the following statements correctly describes the observation above?

- (1) Both X and Y are magnets.
- (2) Both X and Y are magnetic materials.
- (3) X is a magnet but Y is a magnetic material.
- (4) X is a magnet but Y is a non-magnetic material.

23. Which one of the following is a source of light?

(1)



Mirror

(2)



Moon

(3)

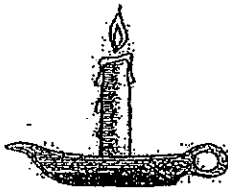

Candle flame

(4)



Diamond ring

24. The driver uses the side mirror as shown below to see the car behind him.



Why do you think he was able to see the car?

- (1) The mirror is a light source.
- (2) The mirror blocks light from the car behind.
- (3) The mirror reflects light from the car behind.
- (4) The mirror absorbs light from the car behind.

25. Look at the picture below.

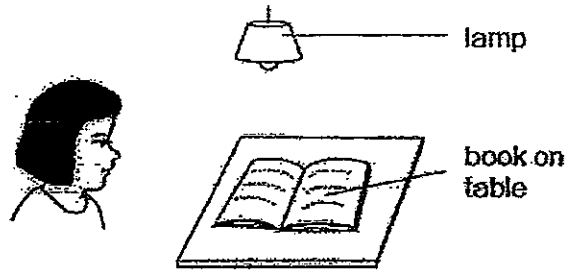

Which one of the following explains why Sue can see the book on the table?

(1)

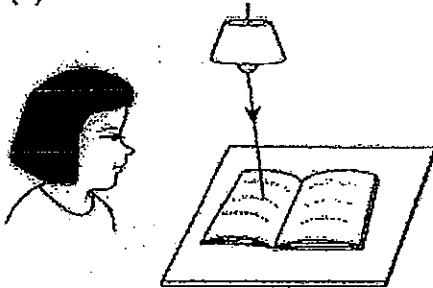

(2)

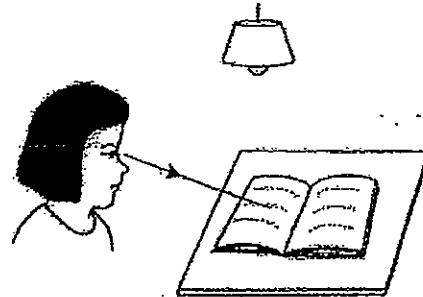

(3)

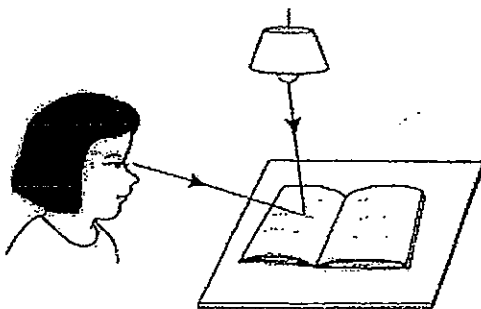

(4)

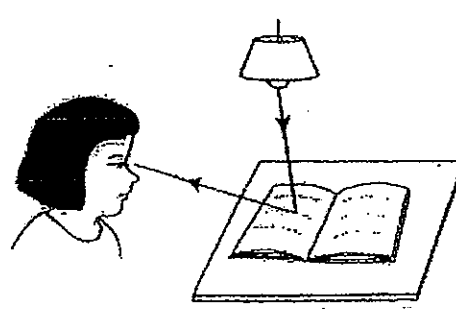

28. What changes do you observe in an ice-cube when it is heated over a flame?

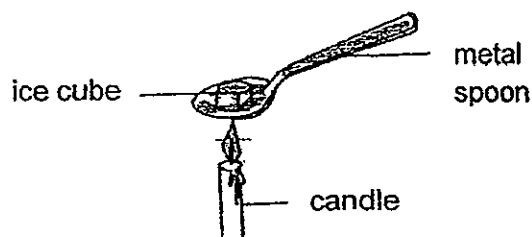

- A: Change in state
- B: Change in shape
- C: Change in colour
- D: Change in temperature

- (1) A and B only
- (2) A and D only
- (3) A, B and D only
- (4) A, B, C and D

29. In the recent 2012 London Olympic, the Olympic torch has been specially designed to allow it to be carried and passed along by 8 000 torch bearers, both adult and young.

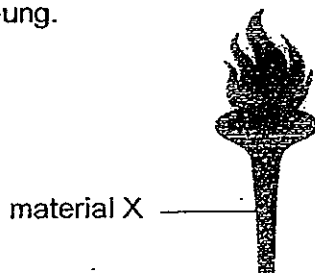

Its exterior is made of Material X which enables the torch bearers to hold the torch for a long time.

Which of the following statements show the characteristics of Material X?

- P: X is heavyweight.
- Q: X is lightweight.
- R: X is a poor conductor of heat.
- S: X is a good conductor of heat.

- (1) P and S only
- (2) Q and S only
- (3) P and R only
- (4) Q and R only

30. The diagrams below show the conditions of electric cables in a day.

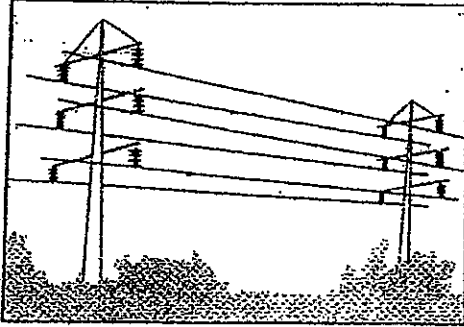

S

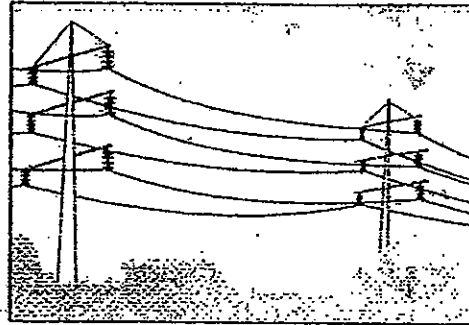

T

Which of the following shows the correct time of S and T?

	S	T
(1)	10 p.m	5 a.m
(2)	10 p.m	1 p.m
(3)	5 a.m	10 p.m
(4)	1 p.m	5 a.m

End of Part 1



Rosyth School
Second Semestral Examination for 2012
SCIENCE
Primary 4



Name: _____

Total
Marks:

Class: Pr 4- _____ Register No. _____ Duration: 1 h.45 min

Date: 24 October 2012 Parent's Signature: _____

Booklet B

Instructions to Pupils:

1. For questions 31 to 44, write your answers in the spaces given in this booklet.

	Maximum	Marks Obtained
Booklet A	60 marks	
Booklet B	40 marks	
Total	100 marks	

* This booklet consists of 13 pages.

This paper is not to be reproduced in part or whole without the permission of the Principal.

Part II: (40 marks)

For questions 31 to 44, write your answers in this booklet.

31. Read the short story below.

Lisa has a few sunflower plants in her garden. One day, she found many tiny butterfly eggs on the leaves of her plants. A few days later, she saw that the eggs had hatched into caterpillars. When Lisa tried to touch one of the caterpillars, it moved away from her. She noticed that the leaves on her plants started to have holes and got much smaller. A few days later, she saw some white cases hanging from the leaves.

What are some of the characteristics of living things that Lisa can conclude? Based on the story above, give a reason for each characteristic. (3m)

	Characteristics of living things	Reason
a)		
b)		
c)		

d) Why do the butterflies lay its eggs on the leaves? (1m)

32. William wanted to find out if temperature affects the length of the life cycle of a seed. The length of the life cycle refers to the number of days needed until the seed grows its first leaves. He planted five seeds in each pot of soil at different temperatures.

Temperature (°C)	20	24	27	30
Length of life cycle (days)	26	18	12	8

- a) From the above results, state the relationship between the temperature and the length of the life cycle. (1m)

- b) Name one variable that should be kept constant in order for a fair test. (1m)

The diagram below shows the seedling.

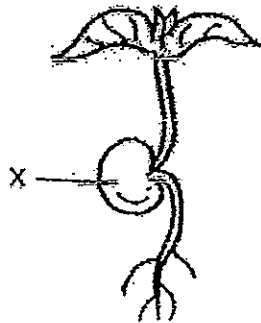

- c) What will eventually happen to the part labelled 'X' as the seedling grows into an adult plant? Explain why. (1m)

33. Choose the correct words from the box to fill in the blanks below.

solid	liquid	gas
-------	--------	-----

a) John pours some marbles from a jar onto a table as shown below. The shape and volume of the marbles remain the same.

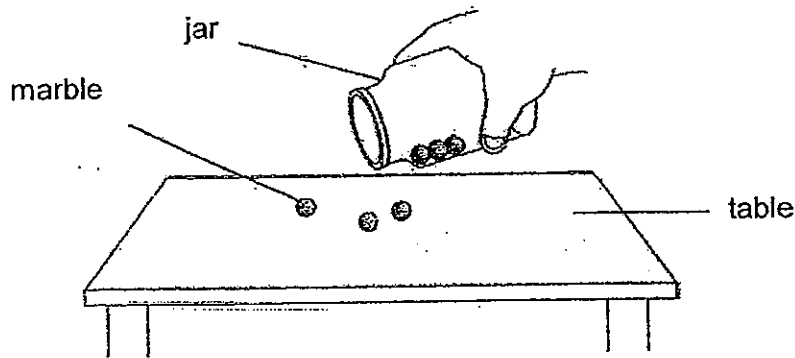

This shows that a marble is a _____ (1m)

b) John pours honey from a jar onto a table as shown below. The volume of honey remains the same but its shape changes.

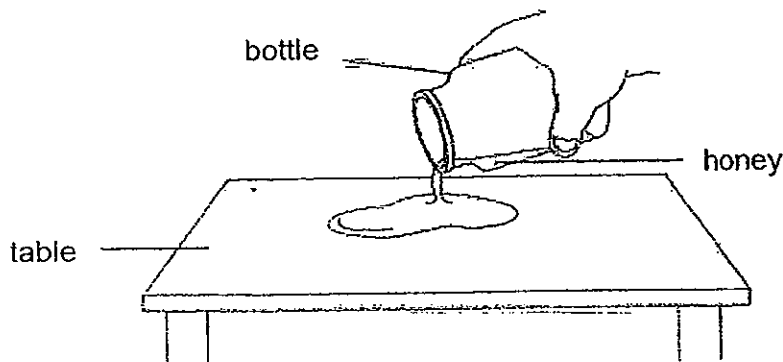

This shows that honey is a _____ (1m)

34. Fiza pushes an empty plastic bottle into a basin of water as shown below. She then unscrews and removes the bottle cap.

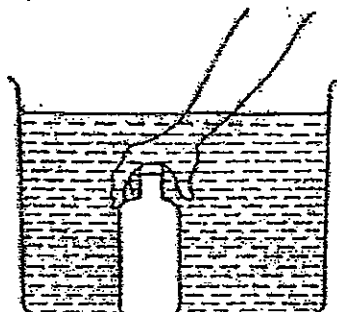

- a) What would she observe? (1m)

- b) Give a reason for the observation. (1m)

Fiza groups the bottle in group Q as shown below.

P	Q
Oil	Bottle
Milk	Marble
Oxygen	Umbrella

- c) Give a suitable heading for P and Q (1m)

P: _____

Q: _____

- d) How are groups P and Q similar? (1m)

36. The diagram below shows the human digestive system.

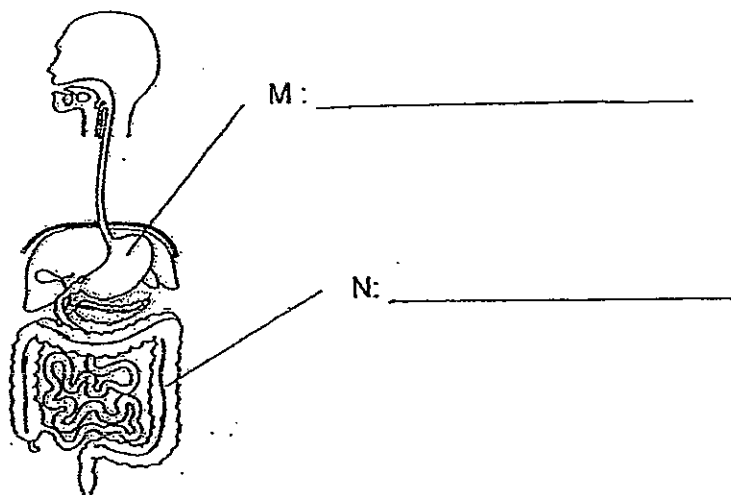

a) Name the parts labelled M and N above. (1m)

b) What happens to the food in part 'M'? (1m)

37. The diagram below shows a pair of swimming goggles.

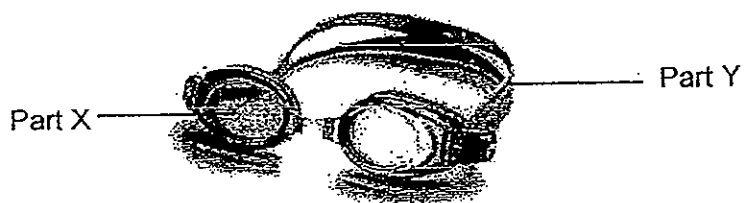

a) Part X is made of clear plastic because it allows _____ to pass through to help the swimmer see under water. (1m)

b) Part Y is made of _____ because Y has to be flexible. (1m)

38. Susan places a magnet near an iron rod as shown below.

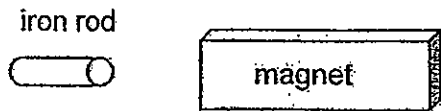

The iron rod starts to move towards the magnet.

Choose the correct word from the box to answer the questions below.
You must not repeat the same word.

hard	force	strong	magnetic	non-magnetic
------	-------	--------	----------	--------------

- a) The magnet exerts a _____ on the iron rod. (1m)
- b) Susan's observation shows that iron is a _____ material. (1m)

39. A thin glass sheet was used to separate a match box and a bar magnet as shown below.

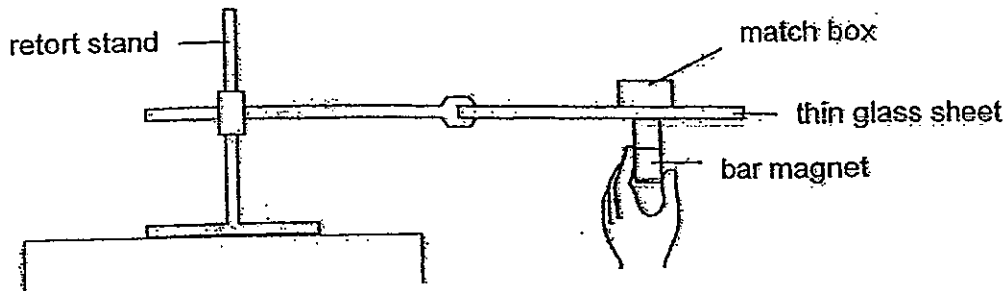

Charles observed that when the bar magnet was moved, the match box moved in the same direction as well. He said that this was due to Object X placed inside the match box.

- a) Based on the observation, what is the characteristic of Object X? (1m)

- b) Support your answer in (a). (1m)

- c) If the glass sheet was changed to a copper sheet of similar thickness, do you think Charles will be able to move the match box with Object X inside? Explain why. (1m)

40. Wei Liang set up an experiment as shown below.

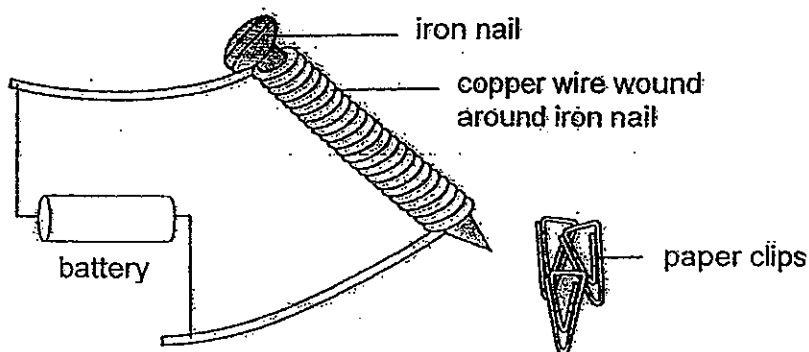

a) Why were the paper clips attracted to the nail? (1m)

He repeated the experiment by increasing the number of coils around the nail and the result of the experiment was given in the table below.

Number of coils around the nail	Number of paper clips attracted
20	2
25	4
30	7
35	8

b) (i) State the measured variable: _____ (1m)

(ii) State the changed variable: _____ (1m)

c) What is the relationship between the number of coils around the nail and the number of paper clips attracted? (1m)

41. Samy placed two similar torches at Point P and Q as shown below.

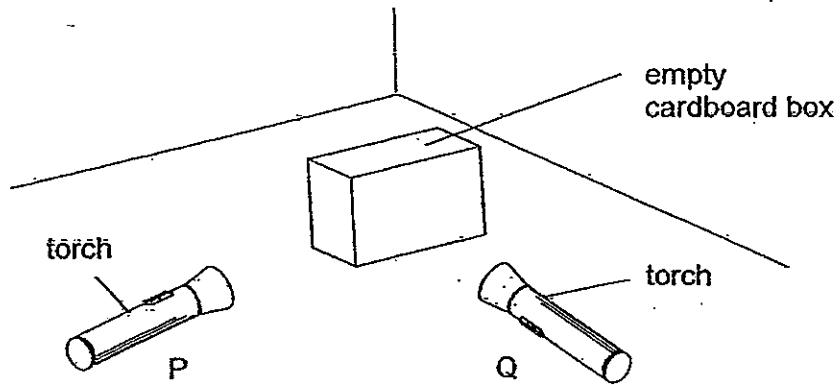

Shadows formed are observed when the torches are switched on.

- a) Draw the shadow of the cardboard box when the torch is placed at Q. (1m)

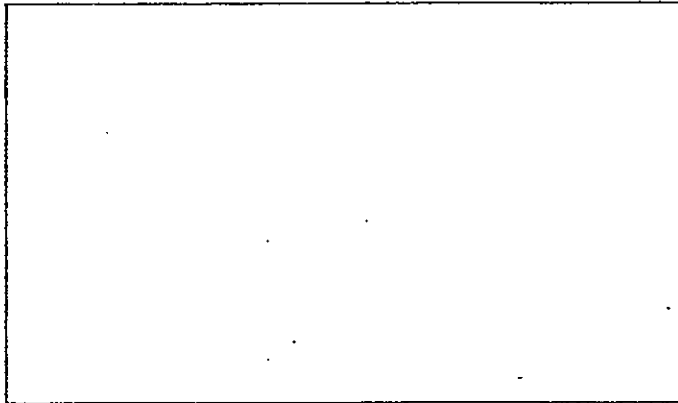

Samy tried to replace the cardboard box with another box made of a different material. However, when he repeated the experiment, no shadows were formed.

- b) What material is the second box most likely made up of? Give a reason for your choice. (1m)

42. Lucy set up an experiment by measuring the amount of light passing through the materials by the light sensor. The results are shown in the graph below.

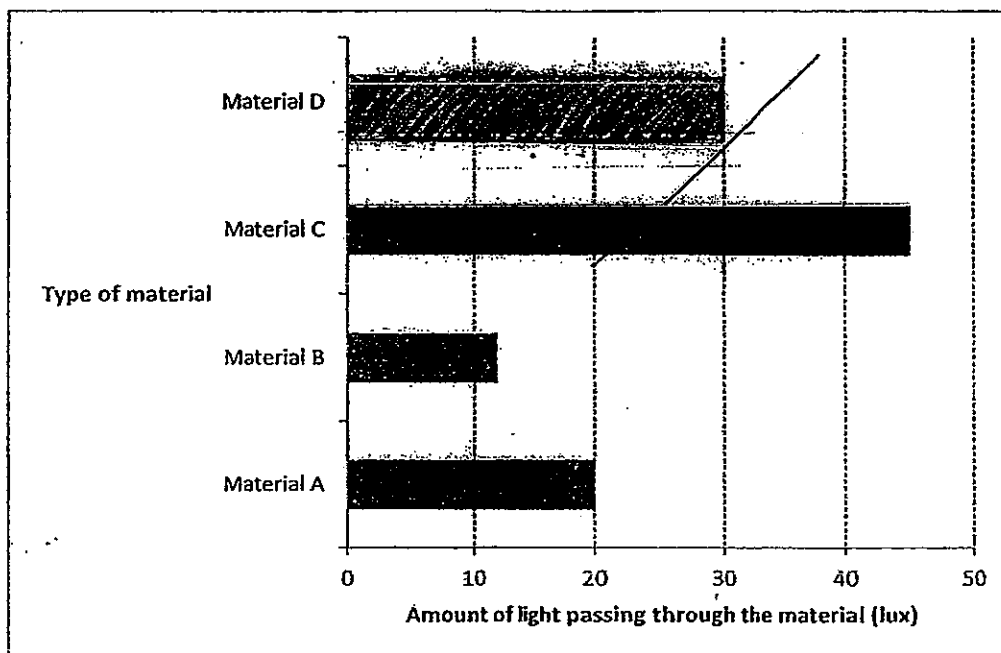

- a) The amount of light passing through by material D is 30 lux. Draw the bar graph in the space provided above. (1m)
- b) Tick the boxes below to indicate the variables that must be kept the same. (1m)

Variables	Tick (✓)
Intensity of light	<input type="checkbox"/>
Type of material	<input type="checkbox"/>
Thickness of material	<input type="checkbox"/>
Location of experiment	<input type="checkbox"/>

- c) On a sunny day, Lucy used an umbrella. Based on the graph above, which is the most suitable material to make an umbrella? Give a reason to support your choice. (2m)

43. Jané used an instrument to measure the temperature of water in a beaker.

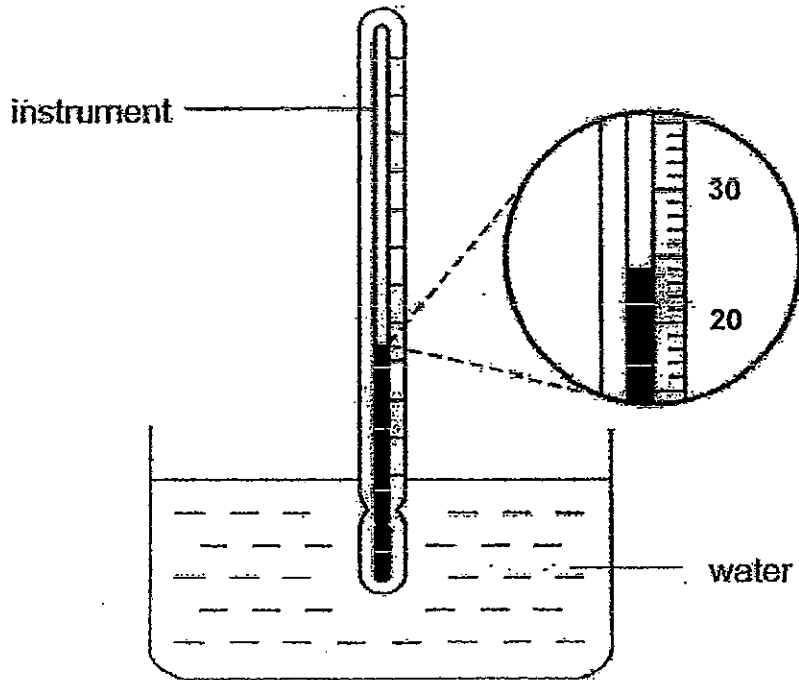

a) What is the instrument called? (1m)

b) What is the temperature of the water in the beaker? (1m)

44. Boon Long and his father ordered a glass of "teh tarik" or tea with milk. He noticed that the drink was made by pouring the mixture of tea and milk up and down between two metal containers repeatedly. His father explained that this action of pouring mixes the tea and milk.

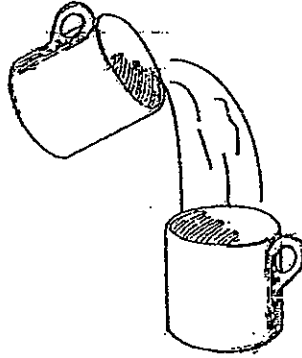

- a) What happens to the temperature of the tea as it is being poured up and down between the containers? (1m)

- b) Give a reason for your answer in part (a). (1m)

- c) Why do you think metal containers are used to prepare the "teh tarik"? (1m)

End of Paper

ANSWER SHEET

EXAM PAPER 2012

**SCHOOL : ROSYTH
SUBJECT : PRIMARY 4 SCIENCE**

TERM : SA2

Q1	Q2	Q3	Q4	Q5	Q6	Q7	Q8	Q9	Q10	Q11	Q12	Q13	Q14	Q15	Q16	Q17
3	3	2	3	2	1	4	1	4	3	1	3	2	3	3	4	3

Q18	Q19	Q20	Q21	Q22	Q23	Q24	Q25	Q26	Q27	Q28	Q29	Q30
3	3	3	1	2	3	3	4	4	2	3	4	2

31)	a) Respond to changes around them	Lisa tried to touch one of the caterpillars, it moved away from her. We can conclude that the caterpillar respond to changes around them.
	b) Reproduce	Lisa found many tiny butterfly eggs on the leaves of her plants, thus, we can conclude living thing reproduce to ensure the continuity of their own kind.
	c) Needs food to survive and grow bigger	The caterpillars ate the leaves on Lisa's plants as the plant started to have holes and get much smaller, thus, we can conclude caterpillars need food to survive.

d) When the egg is born, the caterpillars would have food to eat at the leaves are their food.

32) a) As the temperature increases, the length of the life cycle decreases.

b) Type of seed.

32)c)It will drop off as the food in part X is used up.

33)a)solid.
b)liquid.

34)a)Bubbles will be seen and the water will enter the bottle.
b)Air in the plastic bottle can escape, thus, the water is able to flow in.
c)P: Has no definite shape.
Q: Has definite shape.
d)Both group have mass.

35)a)Set-up A.
b)The roots in set-up A absorb water and mineral salts for the plant, but set-up B does not have roots to absorb water and mineral salts.
c)The plant will turn blue.

36)a)M: Stomach N: Large intestine
b)The food in part M will be half-digested, and then the small intestines where digestion is completed.

37)a)light
b)rubber

38)a)force
b)magnetic

39)a)It is a magnetic material.
b)A magnet is able to attract magnetic materials, but is not able to attract non-magnetic materials.
c)Yes. This is because copper is a non-magnetic material.

40)a)The nail is being magnetised, therefore, it is able to attract the paper clips.
b)i)number of paper clips attracted.
ii)number of coils around the nail.
c)As the number of coils around the nail increase, the number of paper clips attracted also increases.

41)a) 

b)The material might be made of clear plastic, Clear plastic is transparent and allow light to through easily.

42)a)Draw to 30

b)Intensity of light

Thickness of material

Location of experiment

c)It allows the least amount of light to pass through.

43)a)Thermometer.

b)24°C.

44)a)The temperature decreases.

b)The surrounding temperature mixes with the heat in the containers. Thus, heat loss takes place in the container B when the tea is being poured up and down between the containers.

c)I think it is because metal is a good conductor of heat, thus, the "the tarik" would cool down and a good conductor of heat does not keep something warm for a long period of time.

