



RAFFLES GIRLS' PRIMARY SCHOOL

SEMESTRAL ASSESSMENT (2) 2012

Name : _____ Index No: _____ Class: P 5 _____

22 Oct 2012

SCIENCE

Attn: 1h 30min

SECTION A (25 X 2 marks)

For each question from 1 to 25, four options are given. One of them is the correct answer. Make your choice (1, 2, 3 or 4). Shade the correct oval on the Optical Answer Sheet.

Section A	50	
Section B	40	
Your score out of 90 marks		
	Class	Level
Highest score		
Average score		
Parent's signature		

1. The diagram below shows two types of reproductive cells.

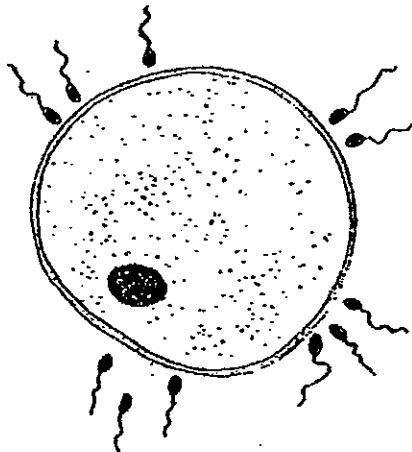

Which one of the following statements about the reproductive cells is correct?

- (1) The fertilised egg will develop into a seed.
- (2) The egg and sperms are produced by the female.
- (3) The process of cell division will take place after fertilization.
- (4) The eggs can be fertilized by two sperms and develop into a baby.

2. The diagram below shows a family tree.

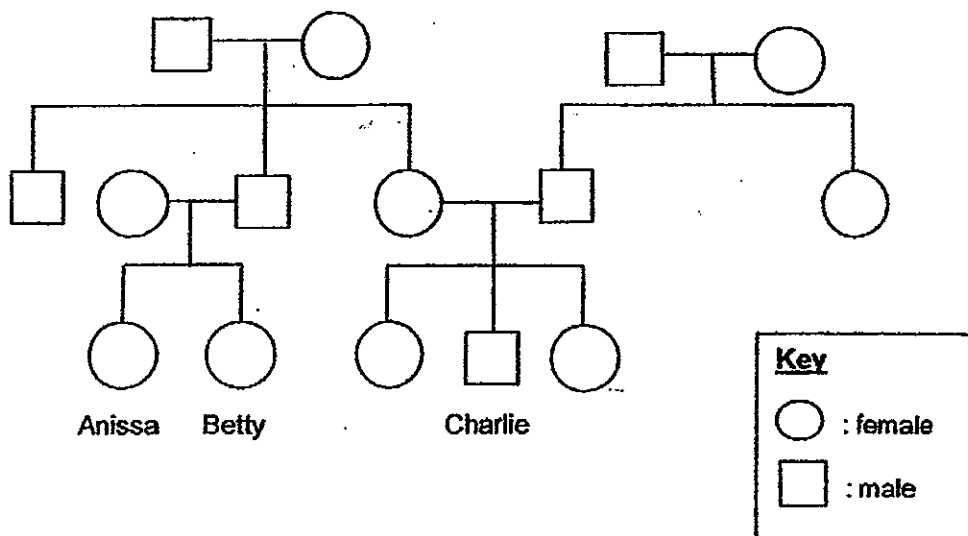

Based on the information above, which one of the following statements is/are correct?

- A Anissa has a sister.
- B Anissa and Charlie are twins.
- C Charlie's mother has 3 brothers
- D Anissa and Charlie's mother are siblings.

- (1) A only
- (2) A and B only
- (3) B and C only
- (4) B, C and D only

3. Jane prepared 4 setups, A, B, C and D, as shown in the diagrams below. After 3 days, she observed that the seeds grew into seedlings in some of the setups.

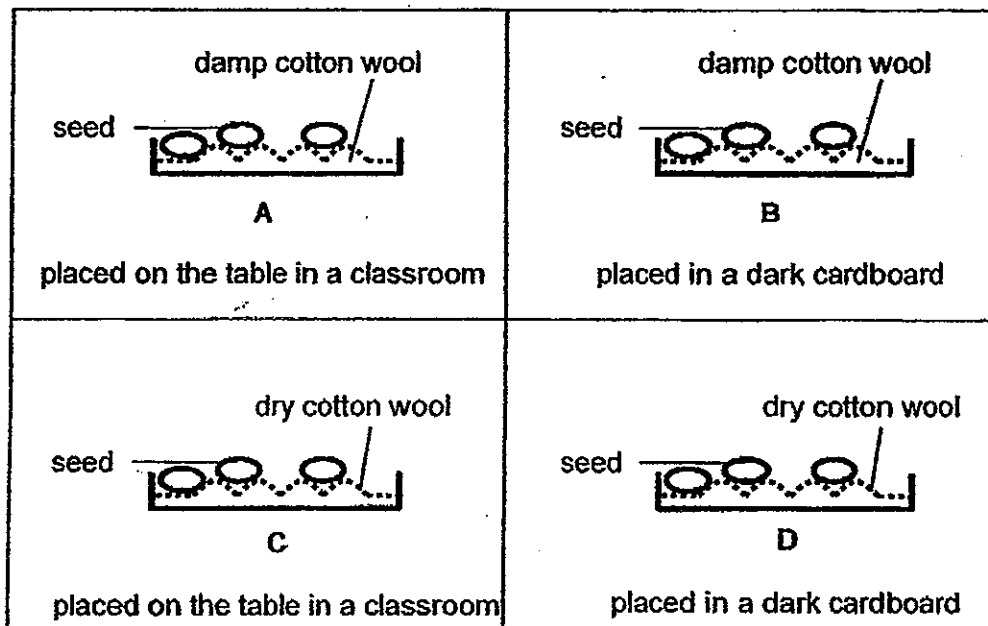

In which one of the following set-ups will the seeds most likely to grow into seedlings?

- (1) A and B only
- (2) A and C only
- (3) B and D only
- (4) A, B and D only

4. The diagrams below show the fruits of three different plants.

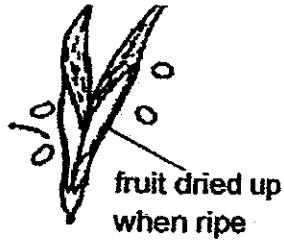

Fruit A



Fruit B



Fruit C

The following diagrams show three possible dispersal patterns, X, Y and Z.

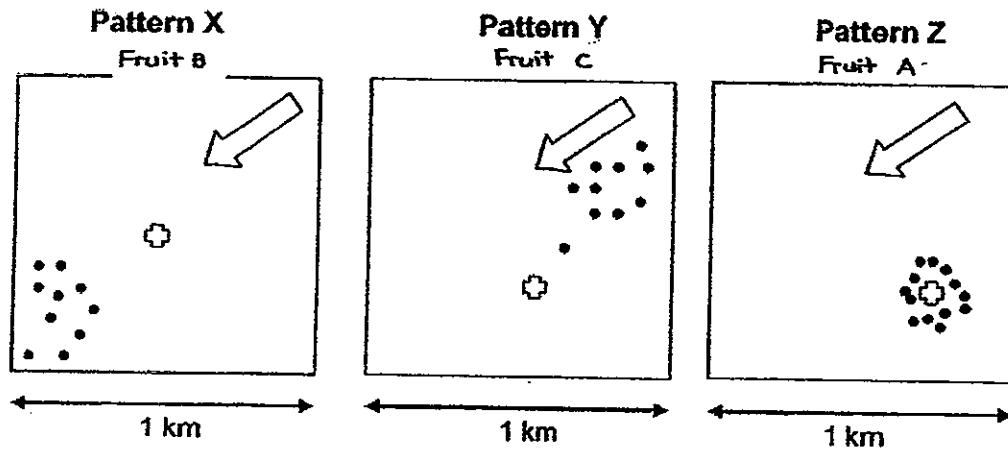

Legends:

- parent plant
- young plant
- direction of wind

Which of the following best represent the dispersal pattern of the fruits A, B and C respectively?

	Pattern X	Pattern Y	Pattern Z
(1)	Fruit A	Fruit B	Fruit C
(2)	Fruit B	Fruit C	Fruit A
(3)	Fruit B	Fruit A	Fruit C
(4)	Fruit C	Fruit A	Fruit B

5. The diagram below shows the vegetation growing in and near a pond.

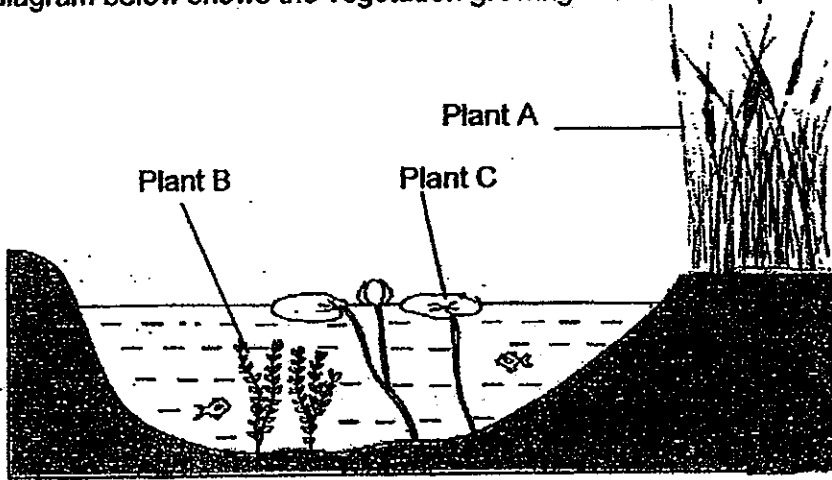

When plant C grew well and covered a large part of the water surface of the pond, the number of plant B decreased.

Which one of the following best explains the decrease in the number of plant B?

- (1) It received insufficient sunlight.
- (2) It received insufficient dissolved carbon dioxide.
- (3) It received excessive dissolved oxygen in the water.
- (4) It was competing with plant A for space.

6. The diagram below shows a human system.

Circulatory System

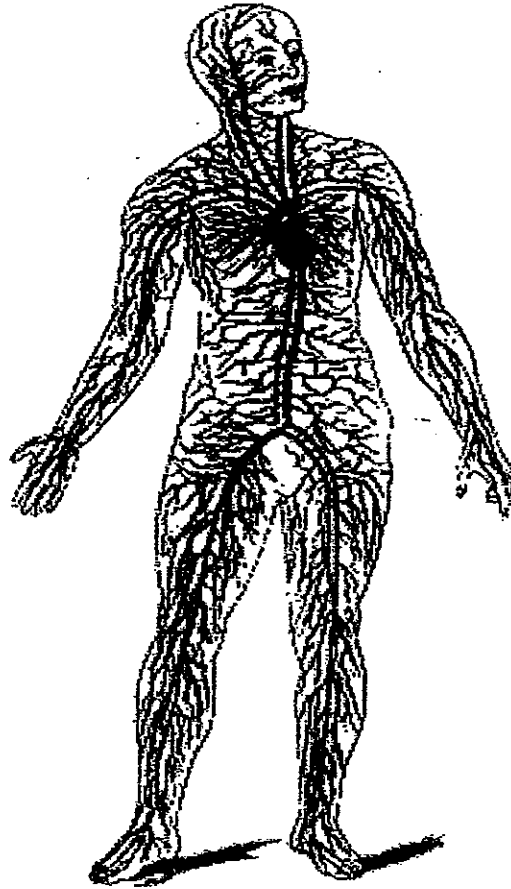

Which of the following are carried by the human system shown above?

- A water
- B oxygen
- C digested food
- D carbon dioxide

- (1) A, B and C only
- (2) A, B and D only
- (3) B, C and D only
- (4) A, B, C and D

7. Study the flow chart about different parts P, Q, R and S in human digestive system below.

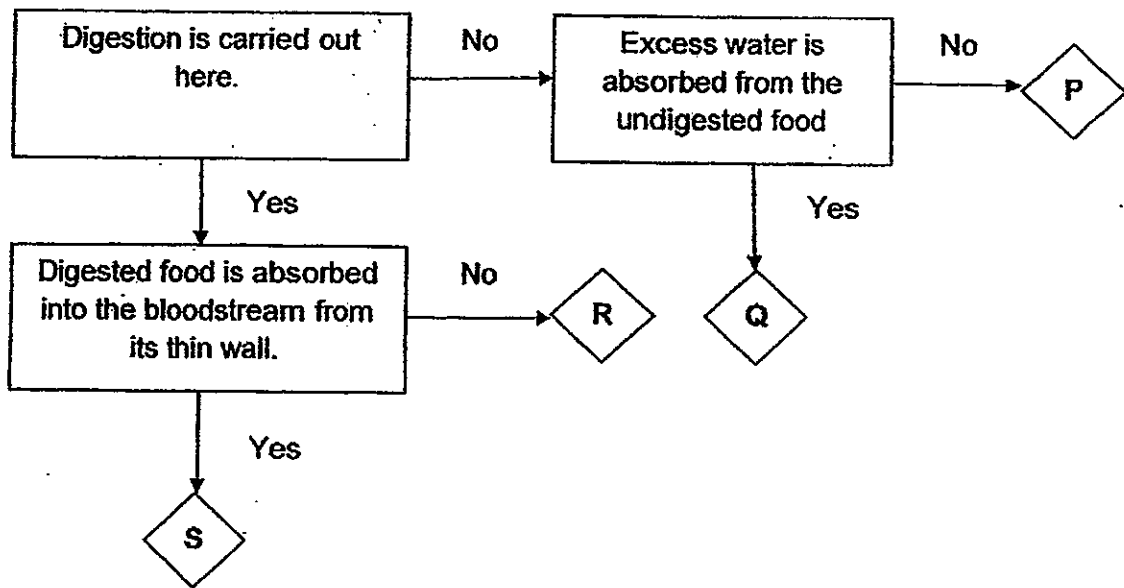

Which of the following best represents P, Q, R and S respectively?

	P	Q	R	S
(1)	anus	large intestine	mouth	small intestine
(2)	gullet	mouth	small intestine	large intestine
(3)	mouth	small intestine	stomach	small intestine
(4)	large intestine	small intestine	Stomach	mouth

8. Which of the following is/ are most likely to go through the process of cell division?

- A A wound healing on a human skin.
- B A new root developing from the main root.
- C A dried brown leaf lying on the ground under a tree.

- (1) A only
- (2) C only
- (3) A and B only
- (4) B and C only

9. Which of the following statements about the respiratory system is correct?

- (1) Water vapour can be found in the air we breathe out.
- (2) Our respiratory system consists of nose, gullet and lungs.
- (3) The air we breathe out contain less carbon dioxide than air we breathe in.
- (4) Only oxygen enters our body when we breathe in through our nose or mouth.

10. The arrows, A, B, C, D, E and F in the diagram below show the flow of blood in a human body system.

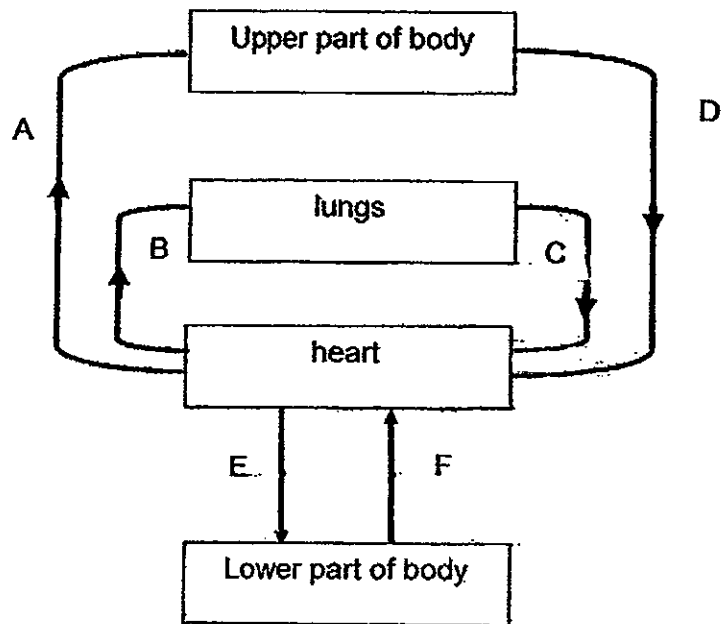

Which of the following contain blood that is rich in oxygen?

- (1) A, B and C only
- (2) A, C and E only
- (3) B, D and E only
- (4) B, C and F only

11. The diagrams below show the different parts of fish and human respiratory system respectively

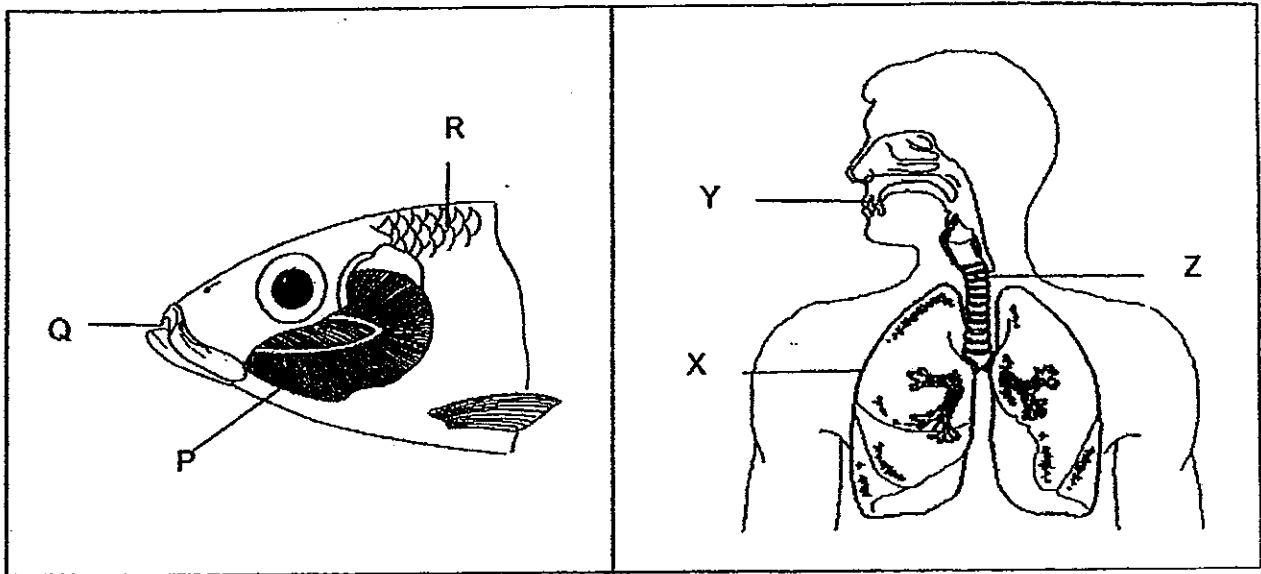

Which of the following correctly matches parts of the fish and human respiratory system that perform similar function?

	Fish respiratory system	Human respiratory system
I.	P	X
II.	Q	Y
III.	R	Z
IV.	P	Z

- (1) I and II
- (2) I and III
- (3) II and III
- (4) III and IV

12. A cross-section of the stem of a plant is shown below.

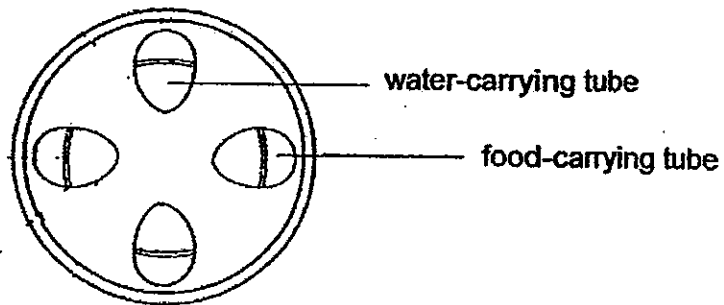

Sam coated most of the leaves of the plant with a thick layer of waterproof black paint on both the upper and underside of the leaves. Then he left the plant in the garden for a week.

Which of the following statements is/are most likely to be the observation made at the end of a week?

- A The water carrying tubes would be stained black.
- B The water carrying tubes would be carrying a mixture of water and food.
- C The amount of food carried by the food-carrying tubes would increase.
- D The amount of food carried by the food-carrying tubes would decrease.

- (1) C only
- (2) D only
- (3) A, B and C only
- (4) A, B and D only

13. Suresh prepared four set-ups, A, B, C and D, using identical plants. The pots are filled with the same type of soil to their brims.

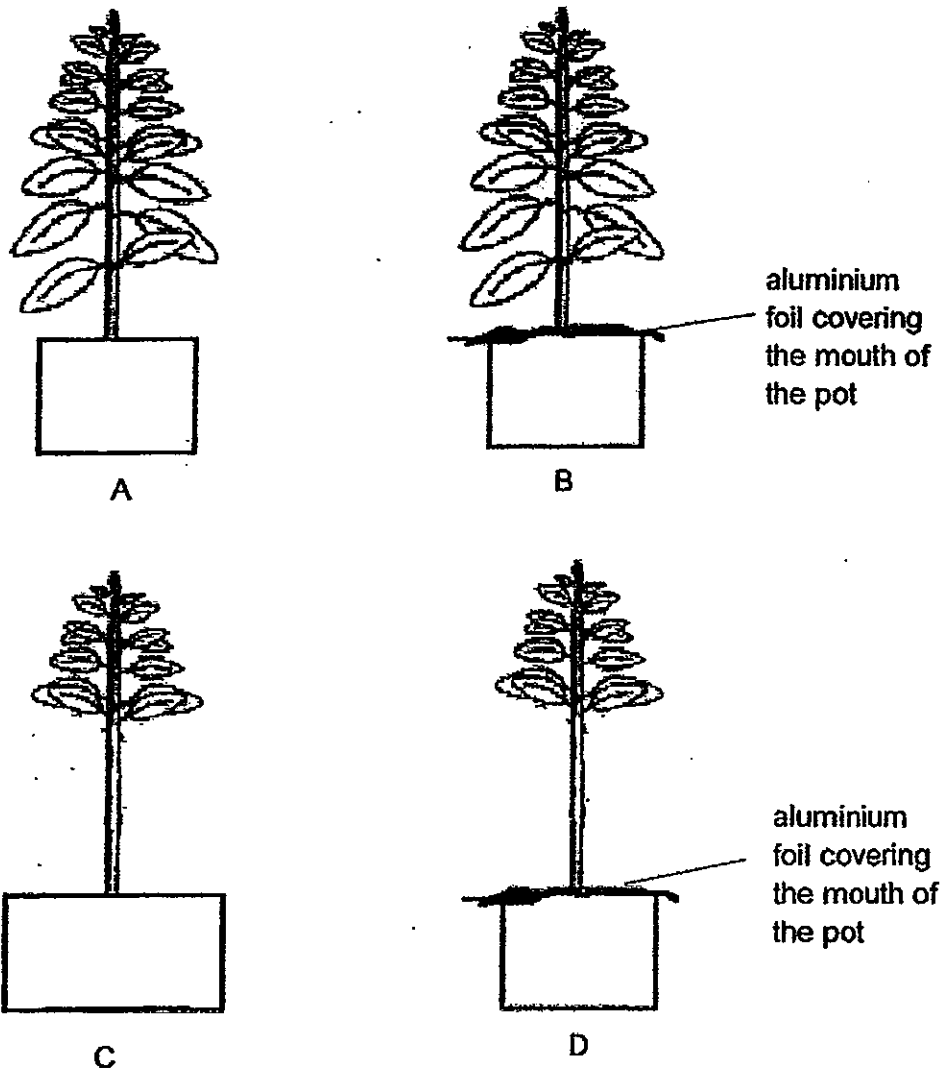

Suresh wanted to find out if the number of leaves affected the rate of water loss of the plants. He measured the mass of two potted plants at the beginning of the experiment and at the end of 3 days.

Which two set-ups should Suresh use in order to carry out a fair test?

- (1) A and C
- (2) A and D
- (3) B and C
- (4) B and D

14. Study the flowchart below.

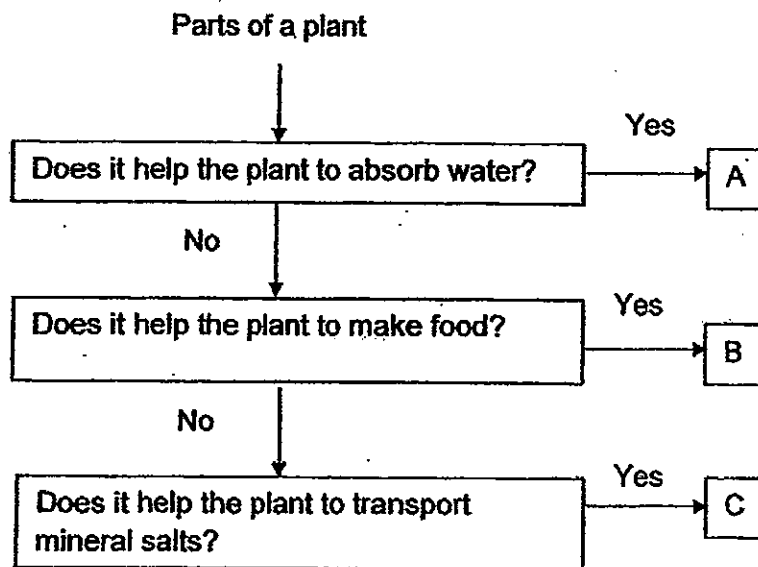

Which of the following correctly represent A, B and C?

	A	B	C
(1)	root	water-carrying tube	leaf
(2)	leaf	food-carrying tube	root
(3)	root	leaf	water-carrying tube
(4)	leaf	water-carrying tube	food-carrying tube

Based on the information below, answer question 15 and 16.

Matthew filled 3 identical beakers each with 200ml of water of different temperature. He placed them on weighing scales and recorded the mass of each beaker and its content as shown in the diagrams below.

He left the 3 set-ups in a room with a constant temperature of 25°C for 15 minutes before he recorded the mass of each set-up.

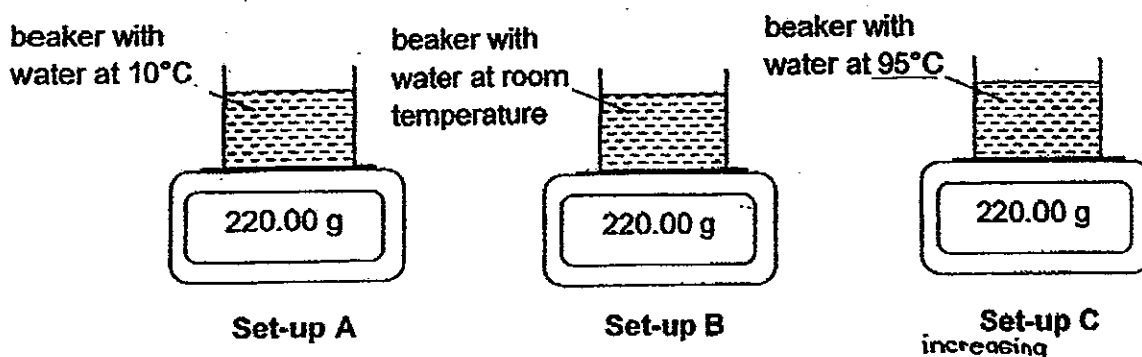

15. Based on the information above, arrange the above set-ups in decreasing order of the mass recorded after 15 minutes, starting from the least to the greatest mass.
- (1) A, B, C
 - (2) B, C, A
 - (3) C, B, A
 - (4) B, A, C
16. Which of the following most likely describe(s) the observations made on set-ups after 15 minutes?
- A Water droplets will be found on the outer surface of the beaker in set-up A, B and C.
 - B Water droplets will be found on the outer surface of the beaker and on the inner surface of the beaker above the water level in set-up A.
 - C Water droplets will be found on outer surface of the beaker in set-up B only.
 - D Water droplets will be found only on the inner surface of the beaker above the water level in set-up C.
- (1) A only
 - (2) A and B only
 - (3) B and D only
 - (4) A, B, C and D

17. The diagram below shows a sundial. It is a clock that uses the position of the Sun to indicate the time. A wooden block casts a shadow upon a surface. On the surface are marking points that indicate the time by the position of the shadow.

Diagram A shows the shadow casts on the sundial at Time X in the morning.

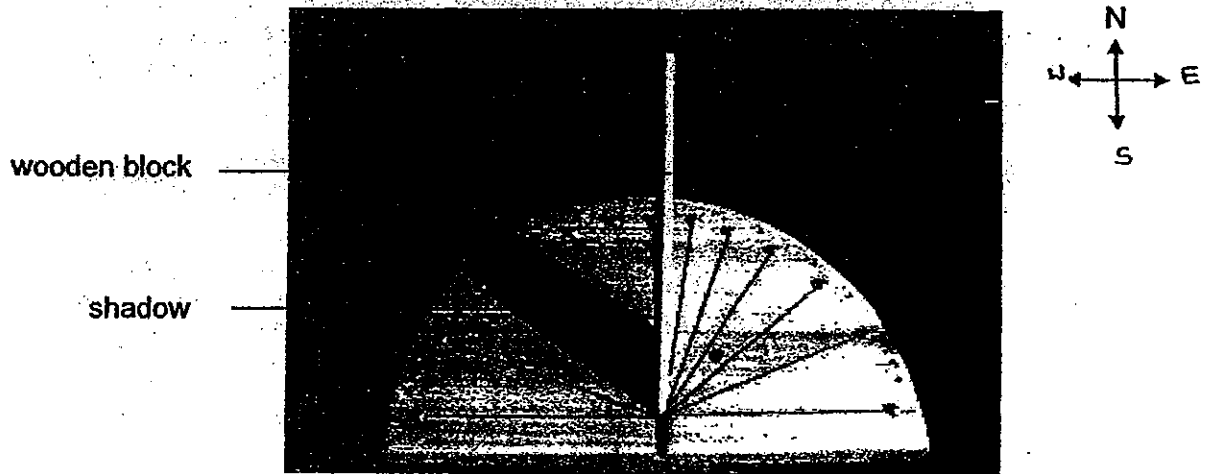

Diagram A

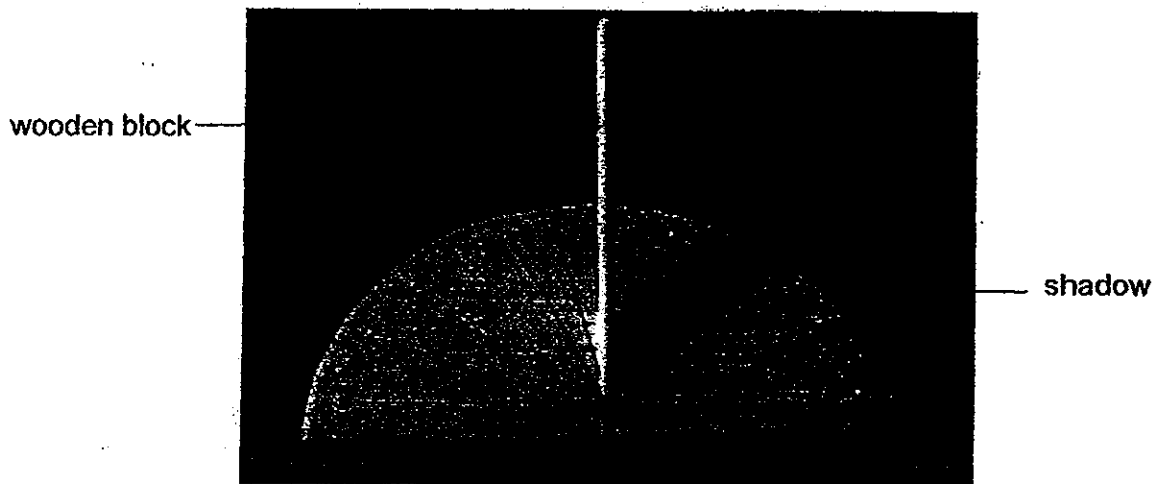
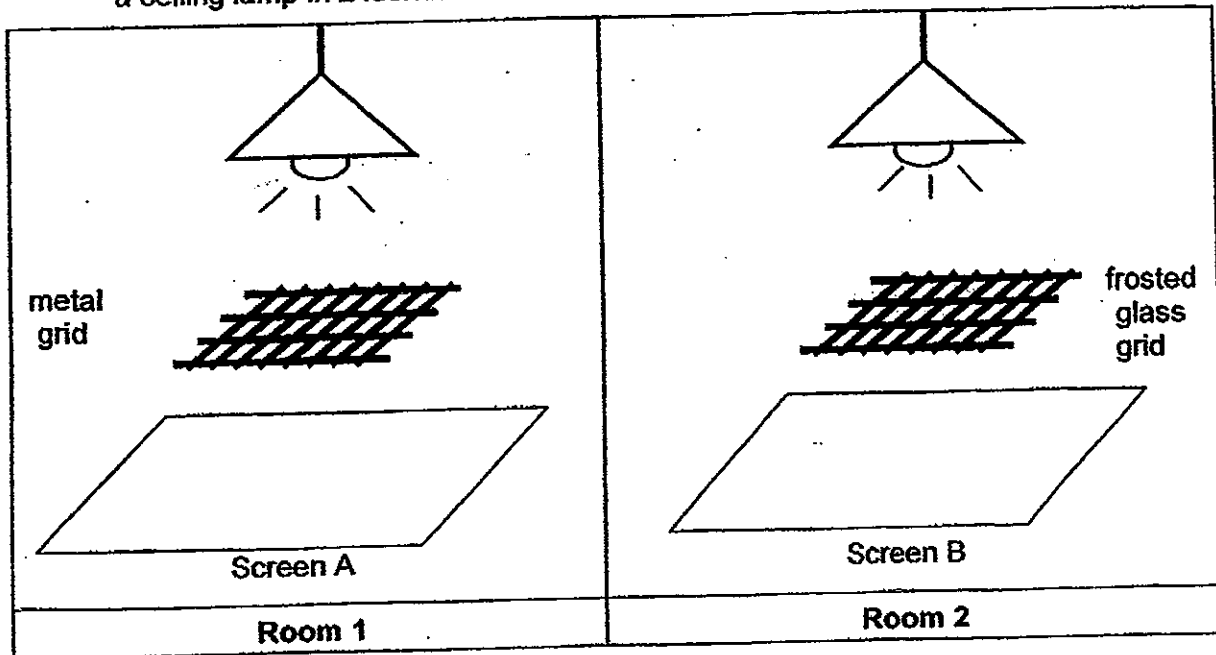

Diagram B

Based on the above information, which of the following statements about the time shown by the sundial in diagram B is most likely to be correct?

- (1) It shows a time at noon. ×
- (2) It shows a time in the morning earlier than Time X.
- (3) It shows a time in the morning later than Time X.
- (4) It shows a time in the afternoon later than Time X.

18. Cindy placed two grids of the same size made of different materials directly under a ceiling lamp in 2 identical dark rooms.



Which of the following shadows would be observed on each screen?

	Screen A	Screen B
(1)		
(2)		
(3)		
(4)		

19. The diagram below shows a fire alarm circuit that operates by using a bimetallic strip.

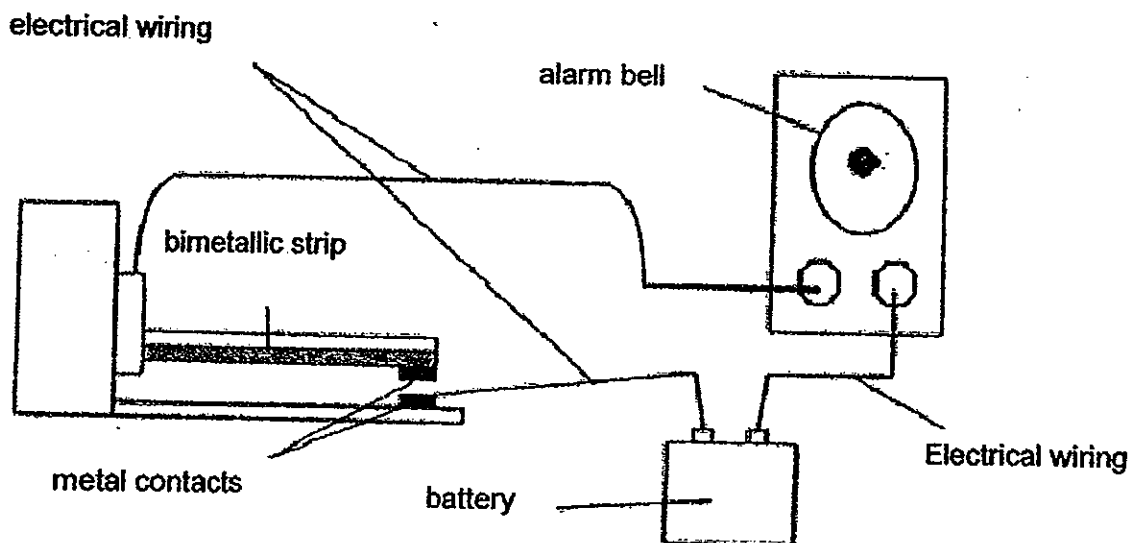

The bimetallic strip in the above fire alarm is made by joining two layers of different metals, A and B, as shown below.

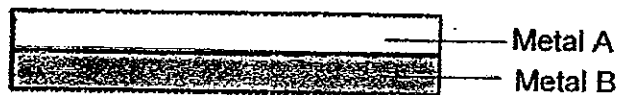

When heated by a fire, the above bimetallic strip bends downwards to allow the metal contacts to touch each other, closing the fire alarm circuit. The fire alarm rings when the circuit is closed.

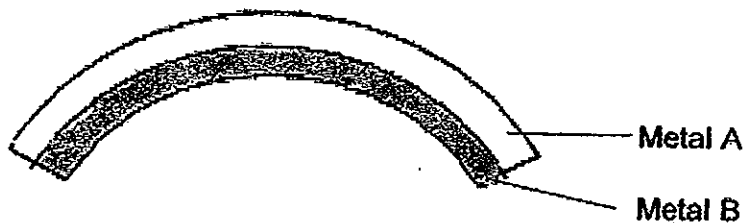

Based on the above information, which of the following about metals A and B is most likely to be true when both metals gain the same amount of heat?

- (1) A expands more than B.
- (2) B expands more than A.
- (3) A expands as much as B.
- (4) B contracts but A expands.

20. An equal amount of boiling water was poured into glass containers X and Y of identical size but of different thickness as shown in the diagram below.

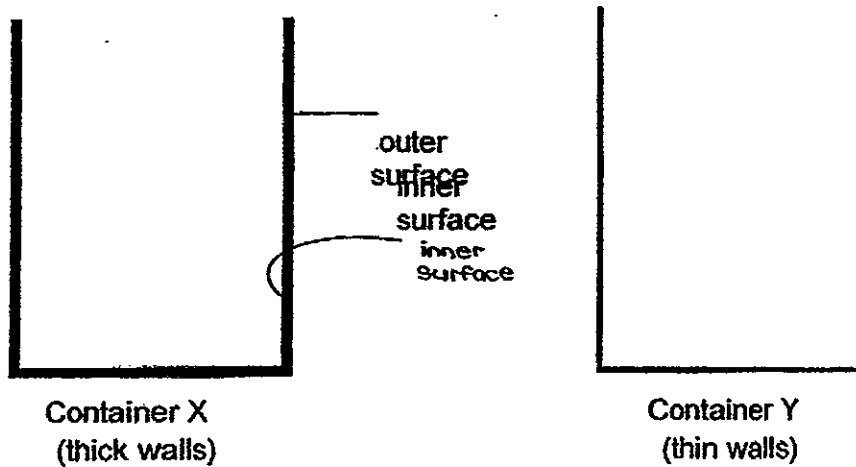

It was observed that some cracks were formed on container X but not on container Y.

Based on the above information, which of the following statements most likely explain(s) the observation made above?

- A The inner surface of container X expanded faster than its outer surface.
 - B The inner surface of container Y contracted faster than its outer surface.
 - C There was more heat in the water in container X so container X gained more heat.
- (1) A only
 - (2) A and B only
 - (3) A and C only
 - (4) B and C only

21. The circuit shown below has 4 connection points namely, A, B, C and D.

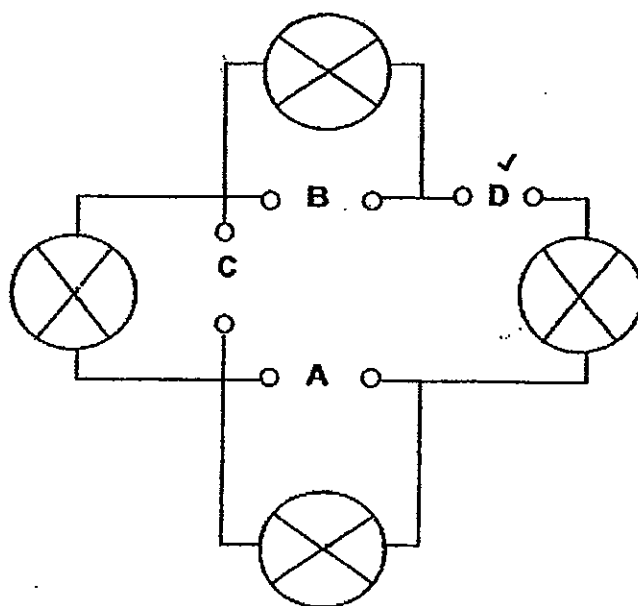

At which position, A, B, C or D, should a battery be placed to light up all the four bulbs?

- (1) A
- (2) B
- (3) C
- (4) D

22. Dalene made a circuit card by clipping some paperclips to it and connected some of the paperclips with copper wire. The diagram below shows her circuit card.

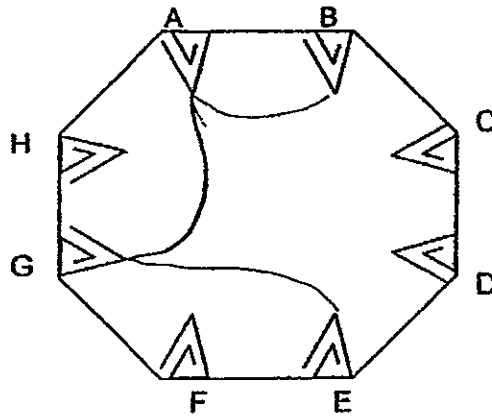

She connected different points of the circuit card to a circuit tester and the results were recorded in the table below.

Points tested	Did the bulb light up?
A and B	Yes
B and D	No
H and C	No
A and G	Yes
C and F	No
G and E	Yes

Which of the following pair of points when connected will definitely cause the bulb in the circuit tester to light up?

- (1) C and D
- (2) H and E
- (3) D and F
- (4) A and E

23. A group of students constructed some electrical circuits as shown below. They wanted to find out which electrical circuit would enable the bulb(s) to lit most brightly.

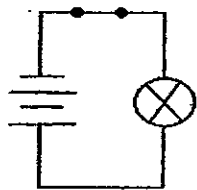

circuit A

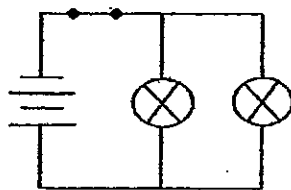

circuit B

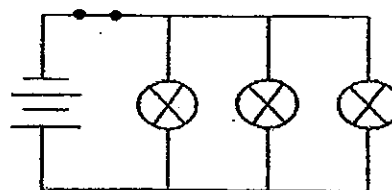

circuit C

The students made the following statements regarding their electrical circuits.

Abby : The bulb in circuit A will be the brightest.

Betty : The bulbs in circuit C will be the dimmest.

Charlene : There should be no difference in the brightness of the all the bulbs.

Which of the following student(s) has/have made the correct statement?

- (1) Abby only
 - (2) Betty only
 - (3) Charlene only
 - (4) Abby and Betty only
24. Study the circuit diagram below carefully.

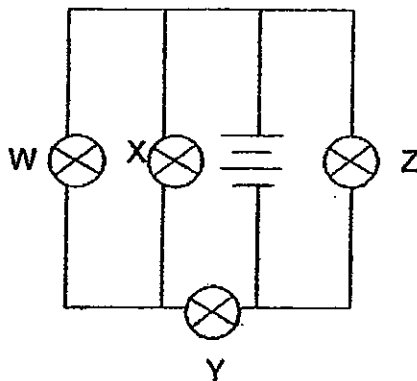

Which of the following bulbs, when fused, would allow only 1 bulb to light up in the circuit?

- (1) W
- (2) X
- (3) Y
- (4) Z

25. Mitchell used four magnets A, B, C and D which were hung from a support and placed over a plastic container each containing 10 identical paperclips. The following diagrams show the number of paper clips each magnet attracted.

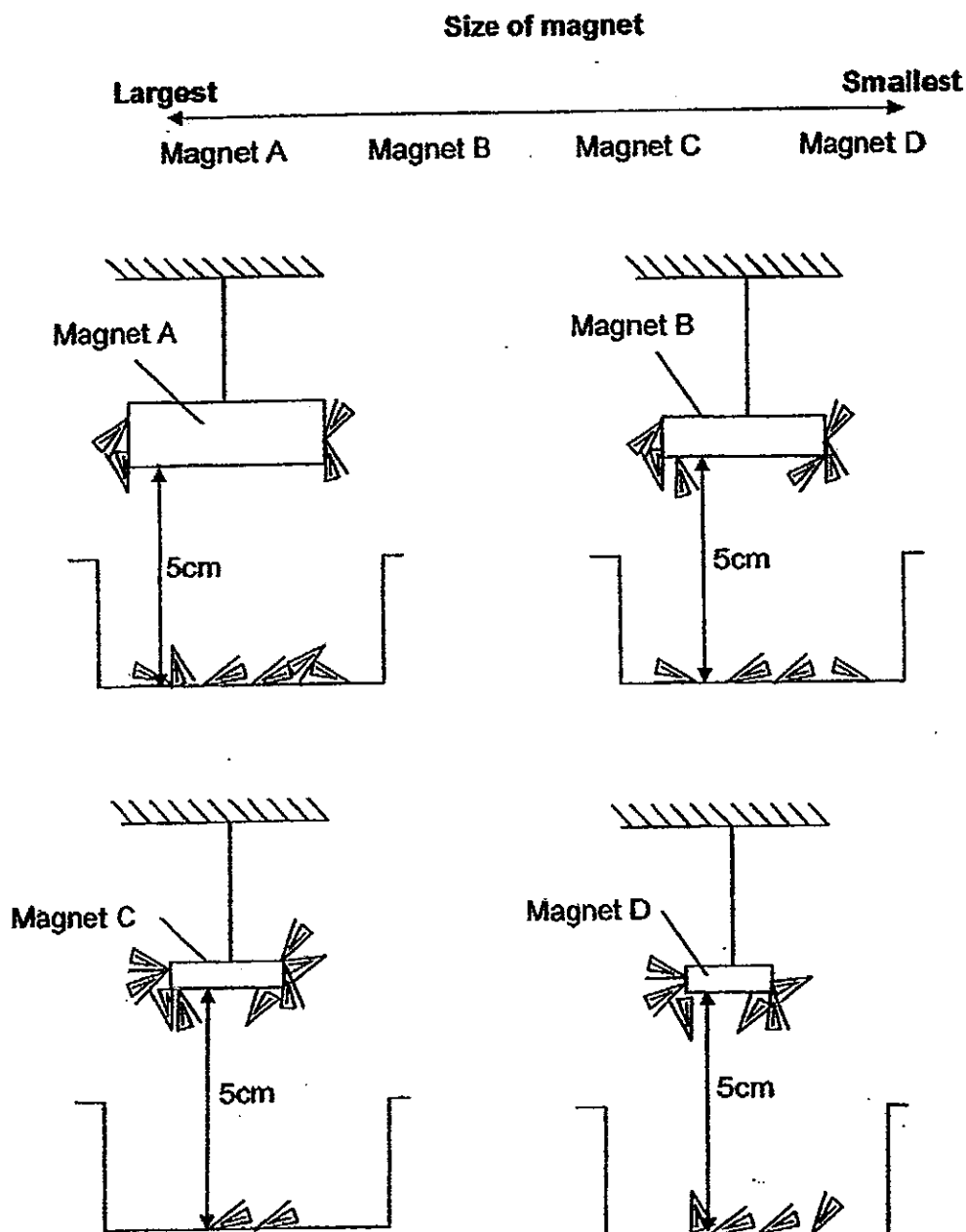

Based on the observation above, which one of the following is most likely to be the conclusion drawn by Mitchell?

- (1) The smaller the magnet, the stronger its magnetic strength.
- (2) The magnetic strength of a magnet does not depend on its size.
- (3) Magnetism can go through non-magnetic material such as plastic.
- (4) The lighter the weight of the magnet, the stronger its magnetic strength.

Name: Sarah

Class: P5

Index No.: _____

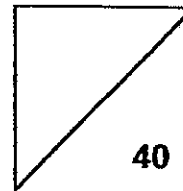

Section B (40 marks)

For questions 26 to 39, write your answers clearly in the spaces provided.
The number of marks is shown in brackets [] for each question or part of a question.

26. The diagrams below show the reproductive system of a flower and a woman.

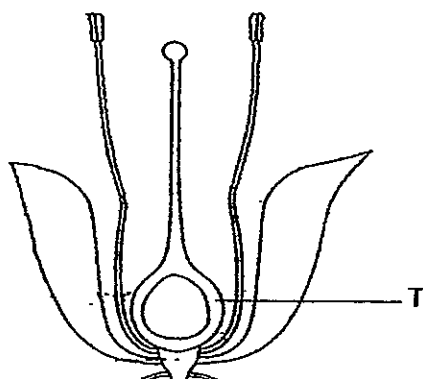

reproductive system of a flower

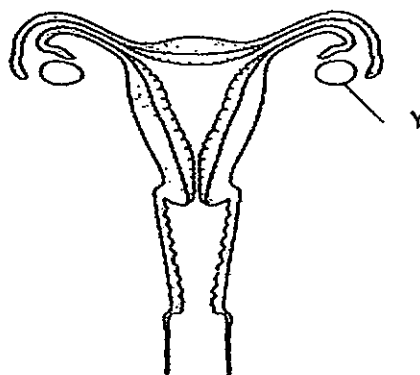

female reproductive system

- (a) In the diagram above, mark "Y" on the part of the female reproductive system that has a similar function as part T. [1]
- (b) State the function of part Y. [1]

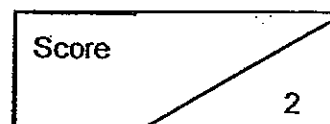

27. (a) In the diagram below, identify the testis and mark it with an "X". [1]

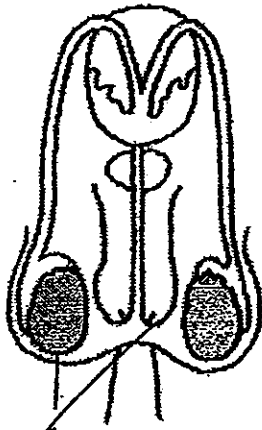

Mr Takashi had a surgery where his sperm ducts were cut and tied up as shown in the diagram below.

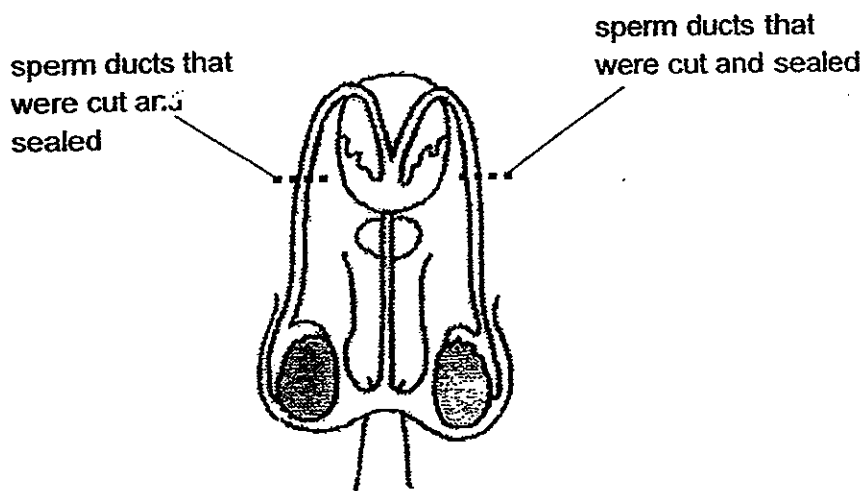

- (b) Based on the diagram above, will Mr Takashi's wife still be able to get pregnant with his child after his surgery? Explain your answer. [2]

Score	3
-------	---

28. Tracy was given two different types of water plants, X and Y, as shown below.

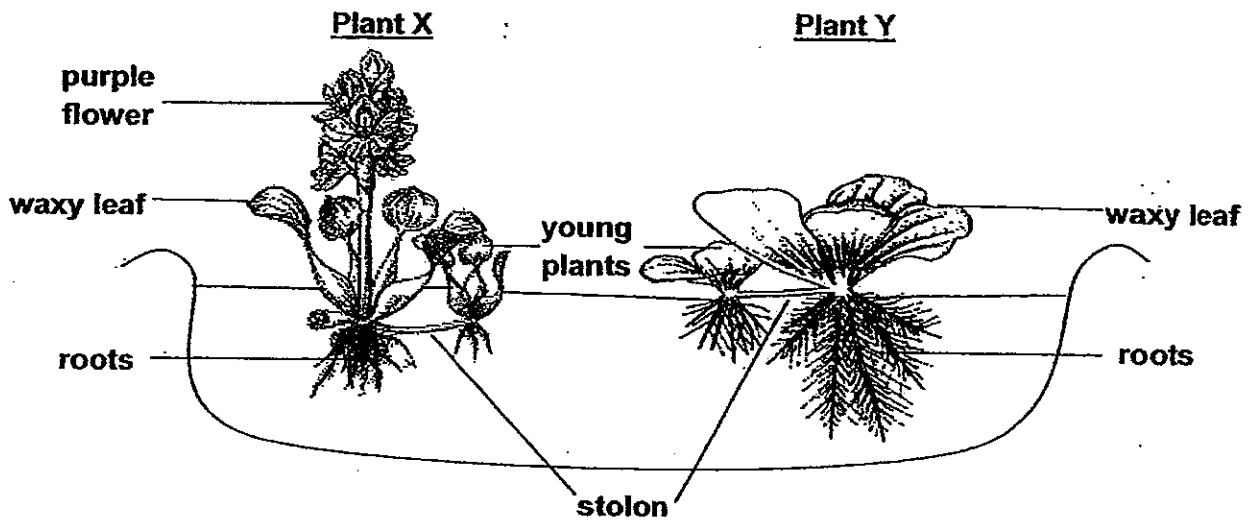

Tracy used the information in the following diagram to identify the water plants X and Y.

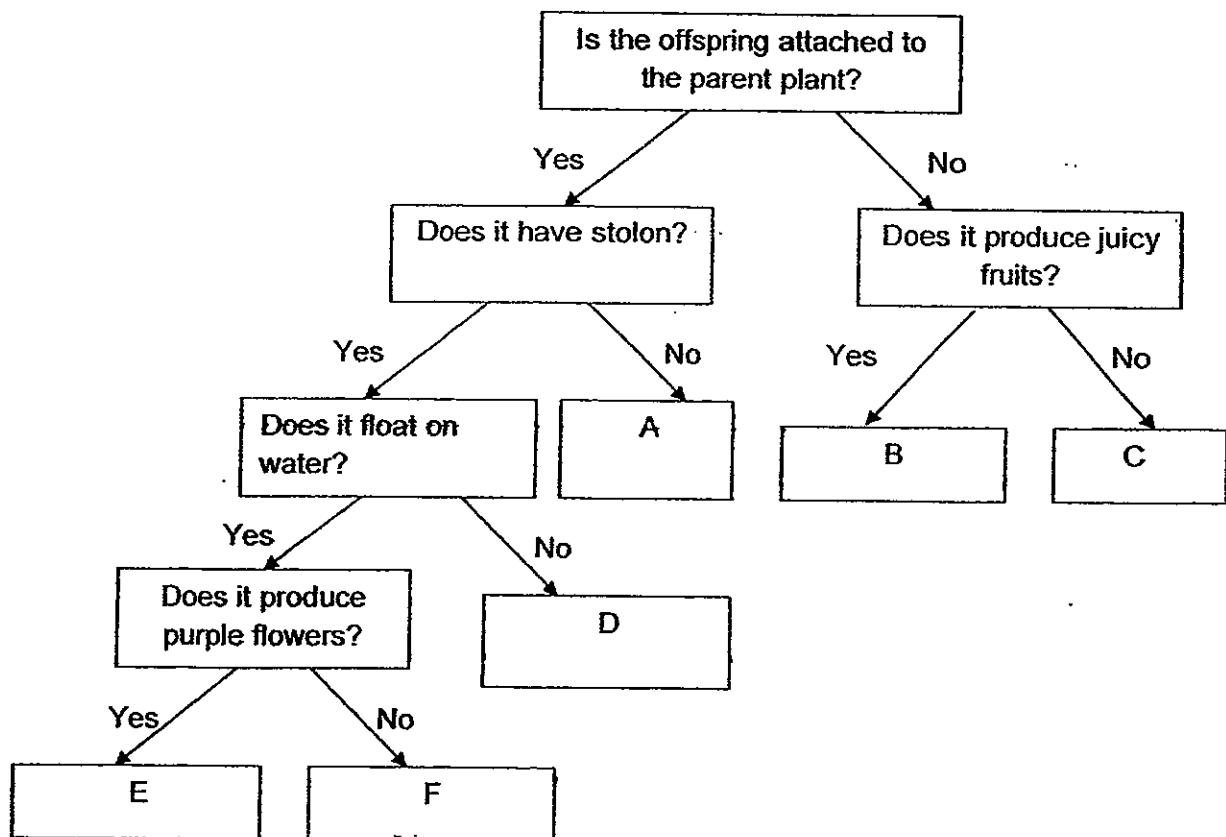

Continue on pg 26

Continued from Pg 25

Based on the given information on the previous page, answer the following questions:

- (a) Which plants, A, B, C, D, E or F, best represent plant X and plant Y. [1]

Plant X : _____

Plant Y : _____

- (b) Based on the flow chart, state one similarity between plant D and F [1]

- (c) After some time, the two plants reproduced and covered the whole surface of the pond.

State one factor which both type of plants would be competing for. [1]

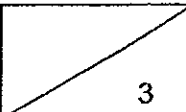
Score	
-------	---

29. Jack carried out an experiment to find out how the number of tiger barb fish affected the amount of dissolved oxygen in the water. He prepared 5 set-ups, A, B, C and D with different number of fish.

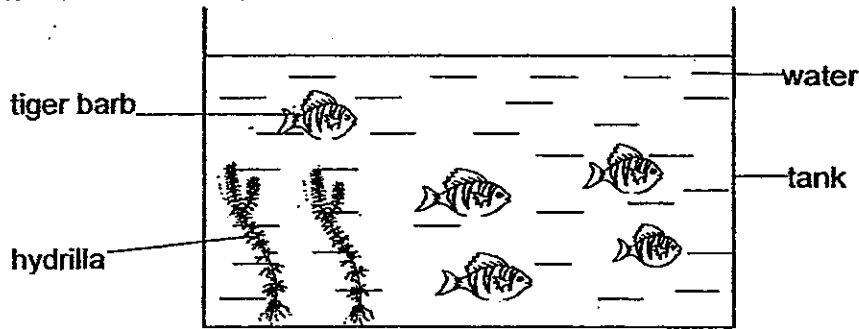

Jack recorded his results in the table below.

Set-up	Number of hydrilla plants	Number of tiger barb	Amount of dissolved oxygen / unit
A	2	0	20
B	2	5	17
C	2	10	14
D	2	15	12

- (a) What is the relationship between the number of tiger barbs and the amount of dissolved oxygen in the water of the tank? [1]

- (b) A week later, Jack removed all the hydrilla plants from all the set-ups. On the following day, he began to observe that the fishes in all the set-ups started to swim near the surface of water.

Explain why the fishes swam near the surface of water. [2]

Score	3
-------	---

2012 P5 Science SA2

30. The diagrams below show three cells A, B and C.

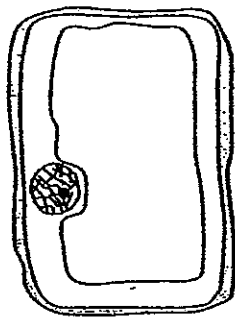

Cell A

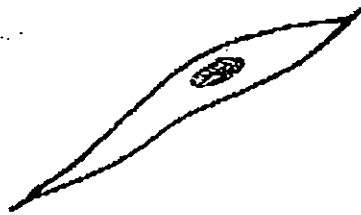

Cell B

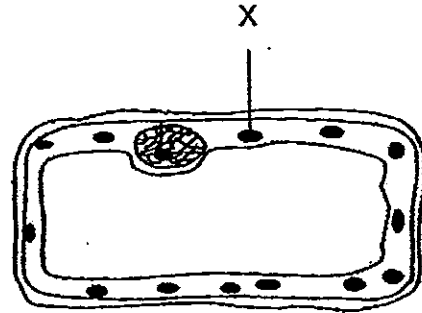

Cell C

(a) Which two cells are taken from a plant? Give a reason for your answer. [1]

(b) When part X of cell C is removed, name the activity that Cell C is not be able to carry out. [1]

Score	2
-------	---

2012 P5 Science SA2

31. The diagram below shows parts of human body system.

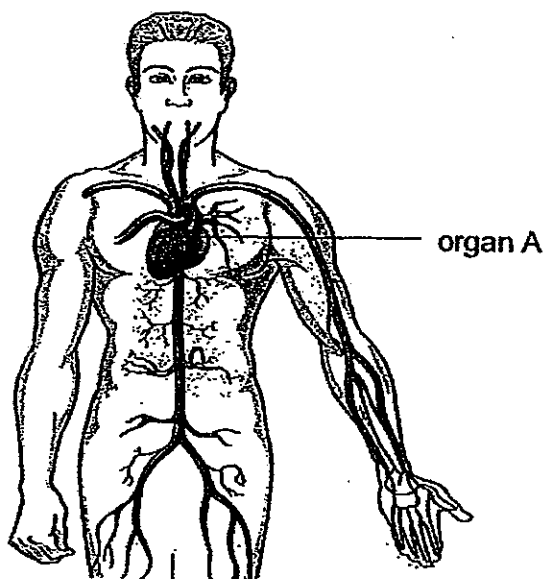

(a) State the function of organ A. [1]

(b) Which part of the skeletal system protects organ A? [1]

Score	
	2

32. Clement carried out an experiment using different number of mice in the set-up shown below.

In the set-up, substance X is used to absorb the carbon dioxide from the surroundings and limewater is used to show the presence of carbon dioxide. The limewater turns chalky when it interacts with carbon dioxide.

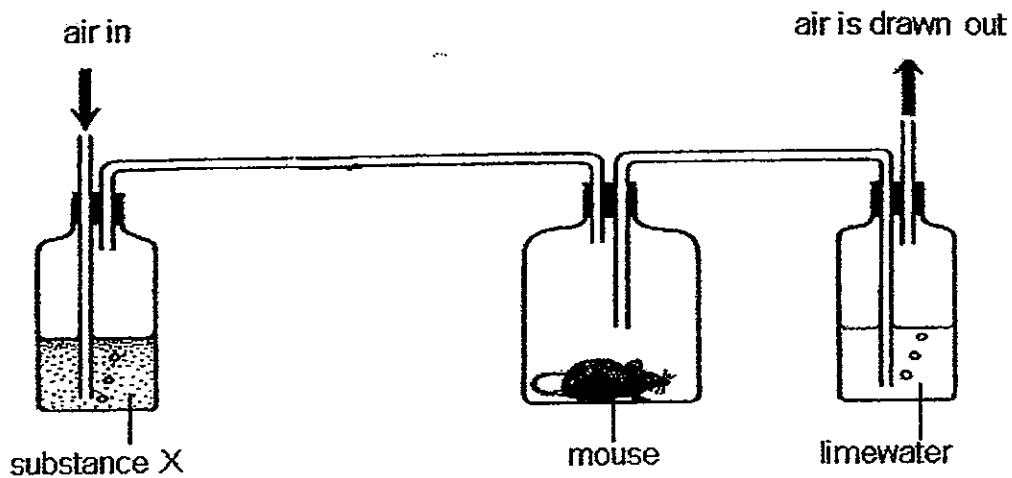

Clement repeated the experiment with two and then three mice respectively. He recorded his observation as shown in the table below.

Number of mouse	Time taken for the limewater to turn chalky (minutes)
1	16
2	11
3	8

(a) Why did limewater in the set-up above turn chalky? [1]

(b) What is the relationship between the number of mice and the time for limewater to turn chalky? Explain your answer. [1]

Score	2
-------	---

(c) Then, Clement replaced the mouse in the bell jar with a plant as shown below.

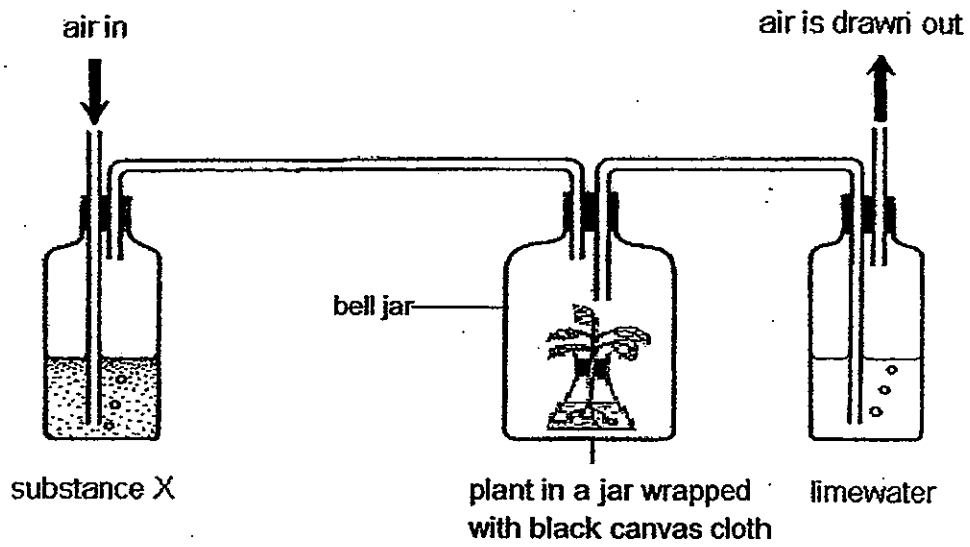

After 2 days, what would he observe of the limewater?

Explain your answer.

[2]

Score	2
-------	---

33. Ali prepared the set-up below to show that water is absorbed by the roots and then carried to the leaves of the plant.

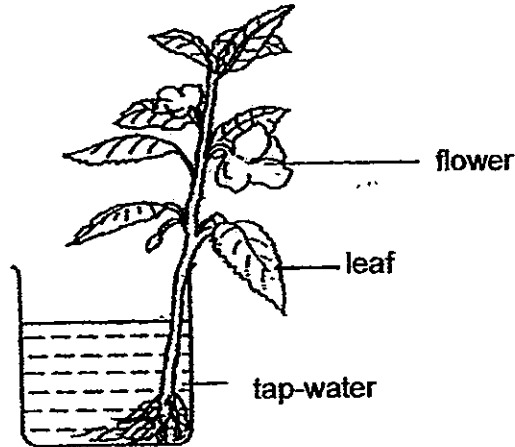

However, Ali's friend suggested that he needed to make 2 changes to the above set-up to show that water was absorbed by the roots and being carried to the leaves of the plant:

Suggest the two changes which Ali should make to the set-up above to show that:

- (i) water was absorbed by the root. [1]

- (ii) water was carried to the leaves of the plant. [1]

Score	2
-------	---

34. The diagram below shows a plant.

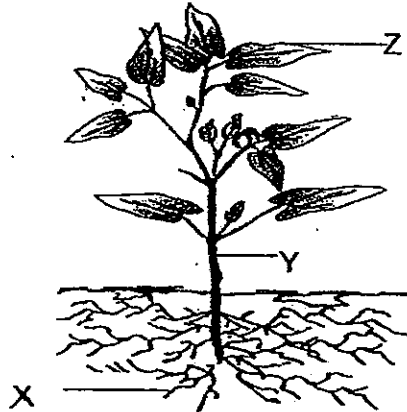

- (a) Identify two substances that are transported from X to Z. [1]
- (i) _____
- (ii) _____
- (b) Besides transporting substances, state **another** function of Y. [1]

Pauline put a plastic bag around her potted plant as shown below. She sealed the plastic bag by tying a string round the stem of the plant.

She watered the plant twice a day by sprinkling some water on the leaves.

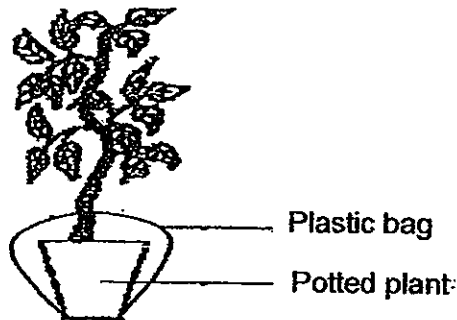

After two weeks, she observed that her plant had withered and died.

- (c) Based on the above information, explain clearly why the plant withered and died after two weeks. [1]

Score	3
-------	---

35. Joanne carried out an experiment by filling different amounts of water into four identical 100-ml rubber containers before they were sealed as shown below.

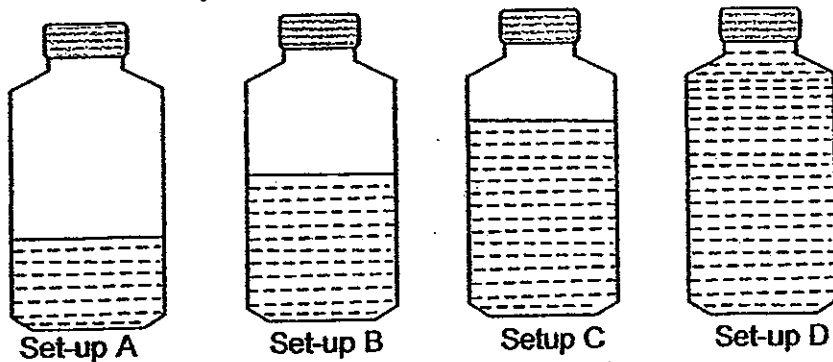

She put the containers filled with water into a freezer. After a day, she recorded her observation in the table below.

Set-up	Volume of water/ cm^3	Volume of ice / cm^3
A	40	45.2
B	60	72.9
C	80	93.7
D	100	109.2

- (a) Based on the information above, what can you conclude about the volume of water when the water freezes? [1]

- (b) If Joanne were to repeat the above experiment by replacing the 100- ml rubber containers with 100-ml glass containers, one of glass containers would crack.

Identify the set-up where the 100-ml glass container would crack in the repeated experiment.

Explain your answer.

[2]

Score	13 12
-------	----------

36. Jack constructed two circuits as shown below. He wanted to find out if the number of coils round an iron rod in a circuit would affect the magnetic strength of the magnetised iron rod.

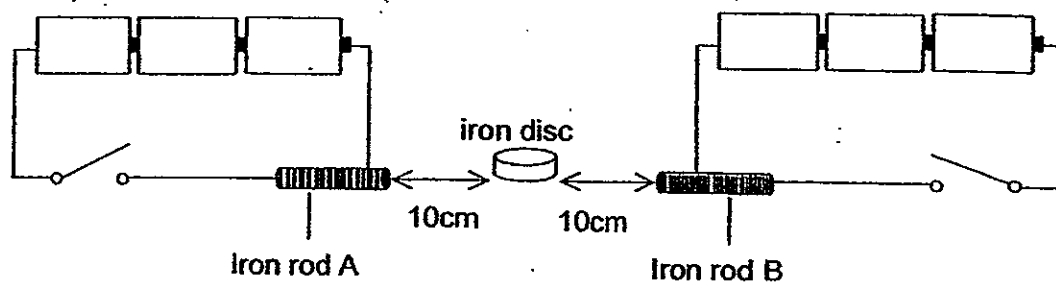

Number of coils round..		Observation
Iron rod A	Iron rod B	
50	100	Iron disc moved towards magnetised iron rod B when the 2 circuits are closed.
100	50	Iron disc moved towards magnetised iron rod A when the 2 circuits are closed.

- (a) What conclusion could Jack draw from the observation above? [1]

- (b) What should Jack do to ensure that his result is reliable?

- (c) Jack replaced the iron rod B with a copper rod with 100 coils around it. Rod A has 100 coils round it too. He then closed the switches in both circuits.

Describe what he would most likely to observe when the circuits are closed. Explain your answer. [1]

Score	3
-------	---

37. Alex wanted to connect two bulbs in such a way that each bulb is controlled individually by only one switch. He drew the circuit diagram as shown below.

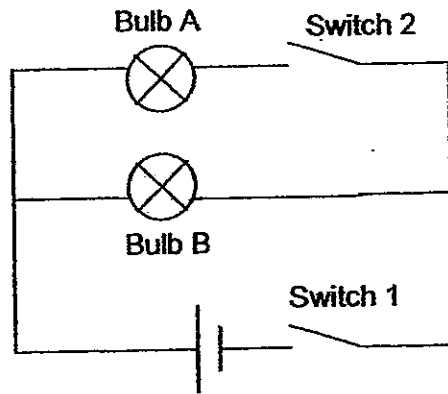

- (a) Does the above circuit enable Alex to control the bulbs individually by only one switch? Explain your answer. [1]

- (b) Using 2 bulbs, 2 switches, 1 battery and some wires, draw a circuit diagram such that the bulbs can be controlled individually, in the box below. [2]

Score	
	3

38. The diagram below shows set-ups X and Y at the end of 5 minutes. Both receive the same amount of heat continuously from the start of the experiment.

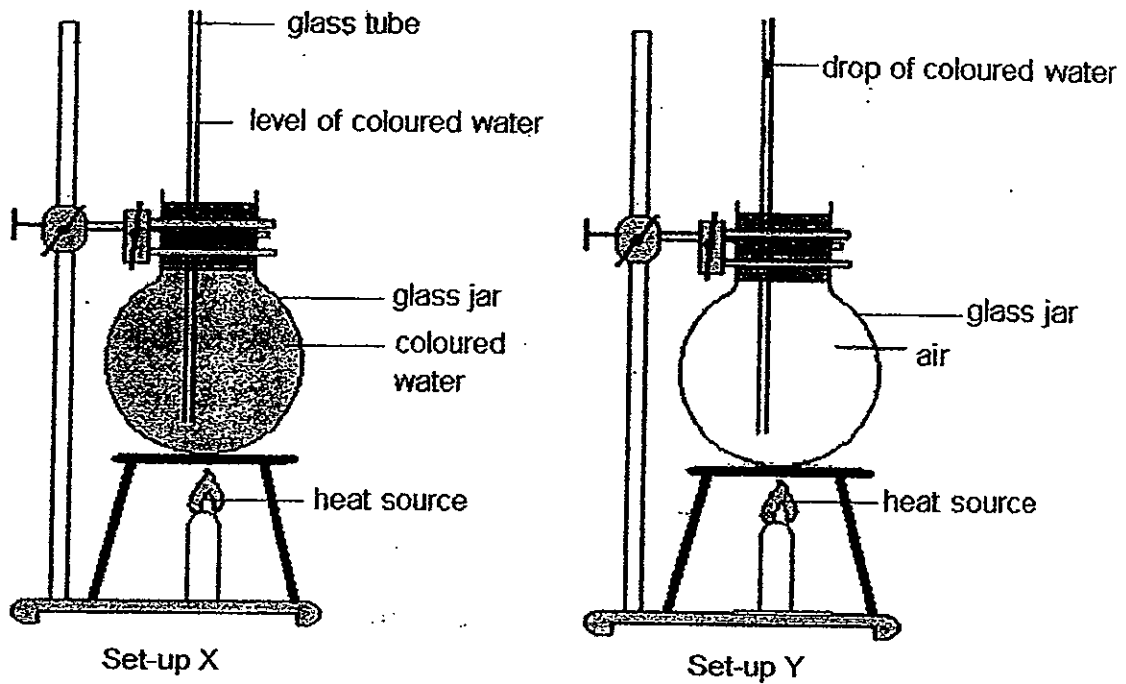

- (a) In set-up X, what would happen to the level of coloured liquid from the 1st minute to the 5th minute during the heating? Explain your answer. [2]

- (b) At the end of 5 minutes, it was observed that the drop of coloured water in set-up Y had risen further up the glass tube than the level of coloured water in set-up X.

Explain the above observation clearly. [1]

Score	3
-------	---

39. Emily made an electromagnet as shown in the diagram below. She placed the electromagnet on a pile of steel paper clips but none of the paperclips was attracted to the electromagnet. She noticed that bulb was brightly lit.

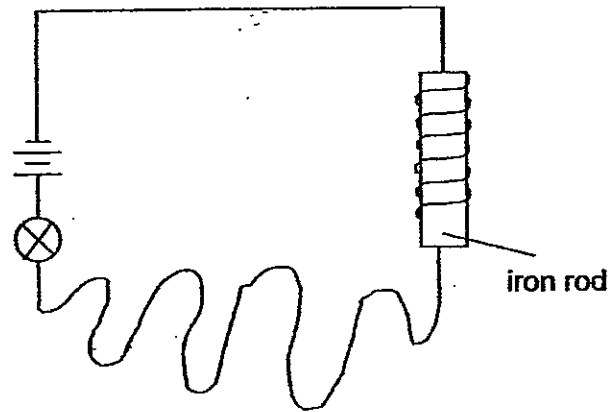

- (a) She changed the set-up slightly without adding any new item or removing any of the existing components. A few paperclips were attracted and lifted by the electromagnet. What change did Emily make to her setup? [1]

Score	1
-------	---

Emily's family owns a recycling company. The company uses an electromagnet to move pieces of used iron and steel from a pile to another bin for recycling

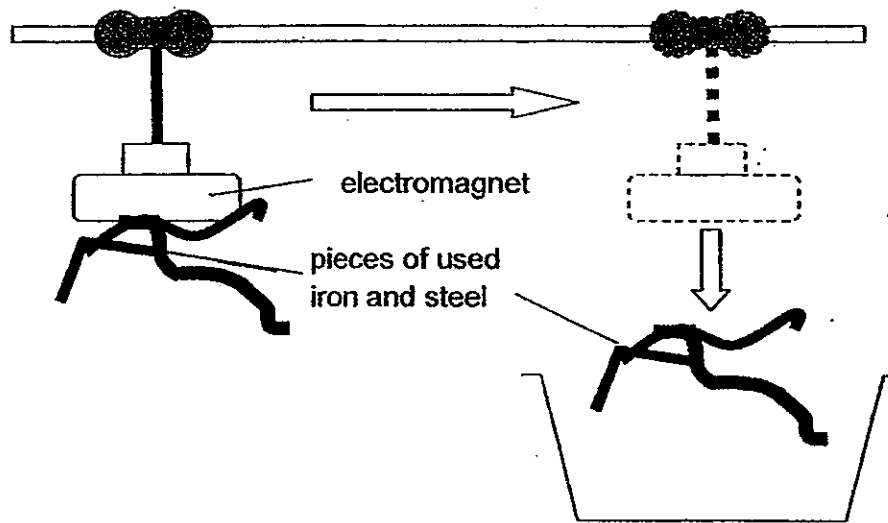

Emily conducted a fair experiment to find out which material, A, B or C, is most suitable to be used to create the electromagnet. The table below shows the result of her experiment.

Materials	Number of iron nails attracted when electromagnet was turned on	Number of iron nails still attracted when electromagnet was turned off
A	100	75
B	80	10
C	55	10

- (b) Based on the information above, which material is most suitable to be used to make the electromagnet of the sorting device in the recycling company? Give a reason for your answer. [1]

Score	1
-------	---

Emily built a device with the aim to separate metallic and non-metallic items as shown in the diagram below. She poured a mixture of items onto a moving belt B.

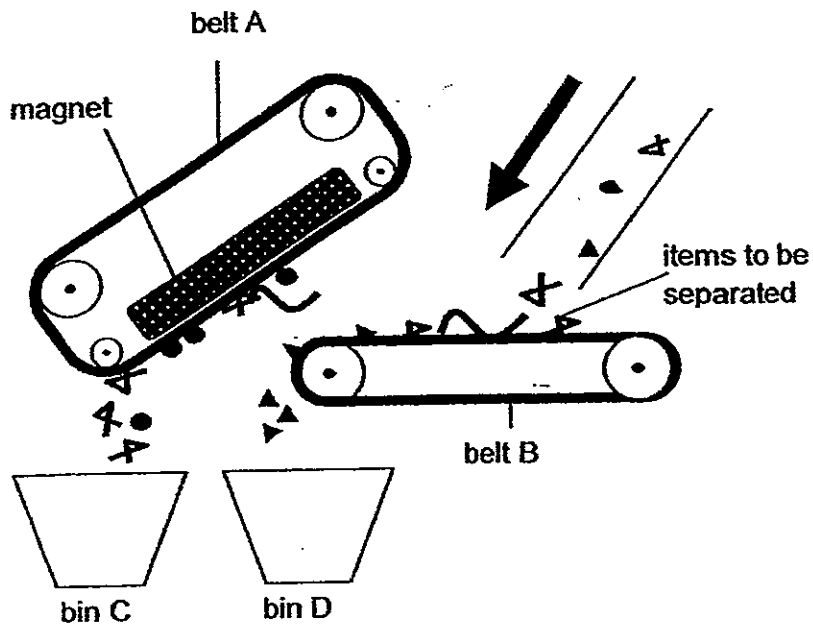

The lists of items to be separated are as follows:

Iron nails	Copper wires	Glass bottles	Plastic bottle
Steel spoon	Nickel rods	Ceramic mug	Cotton blouse

- (c) Will she be able to separate the above items into metallic and non-metallic items effectively using her device? Explain your answer. [2]

END OF PAPER

Score	2
-------	---



ANSWER SHEET

EXAM PAPER 2012

**SCHOOL : REFFLES GIRLS'
SUBJECT : PRIMARY 5 SCIENCE**

TERM : SA2

Q1	Q2	Q3	Q4	Q5	Q6	Q7	Q8	Q9	Q10	Q11	Q12	Q13	Q14	Q15	Q16	Q17
3	1	1	2	1	4	1	3	1	2	1	2	4	3	3	3	4

Q18	Q19	Q20	Q21	Q22	Q23	Q24	Q25
3	1	1	4	4	3	3	2

26)a)

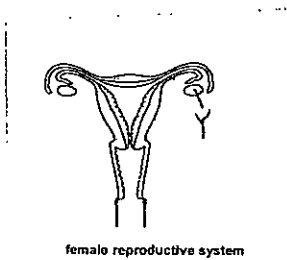

b)Part Y contains the female sex cell.

27)a)

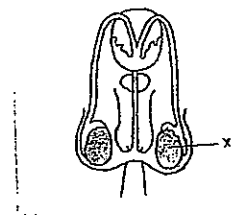

27) b) No. As the sperm ducts were cut and sealed, the sperms could not be released and fertilise with the egg.

28) a) X: E Y: F

b) Plant D and F have stolon.

c) Sunlight.

29) a) The more the number of tiger barbs, the lesser the amount of dissolved oxygen in the water of the tank.

b) The water did not have enough dissolved oxygen and the fishes did not have any plants to provide dissolved oxygen for them thus, it swam near the surface to get dissolved oxygen.

30) a) Cell A and C. Both cell A and C contains a cell wall which all plant cells wall.

b) Cell C would not be able to make food for the plant.

31) a) Organ A pumps blood to all parts of the human body.

b) The ribcage.

32) a) The limewater would turn chalky when in contact with carbon dioxide.

Carbon dioxide is produced by the mouse thus, the limewater would turn chalky.

b) When the number of mice increases, the more the carbon dioxide given out.

c) The limewater would turn chalky. Limewater turns chalky when in contact with carbon dioxide. The plant that is covered with a black cloth would not be able to photosynthesis in the dark but would give out carbon dioxide and take in oxygen.

33) i) He should add a layer of oil on top of the tap-water.

ii) He should add colouring to the tap-water.

34) a) i) Mineral Salts. ii) Water.

b) It holds the plant upright.

c) The plastic bag prevented water from reaching the roots. Therefore, the roots did not have any water to take in in other for it to survive.

35) a) The volume of water would increase.

b) The glass container is not elastic.

36) a) The greater the number of coils around the iron rod, the greater the magnetic strength of the electromagnet.

b) He should repeat the experiment three times or more.

c) Circuit A. Copper cannot be magnetised.

37)a)No. Switch I would control all the bulbs.

b)

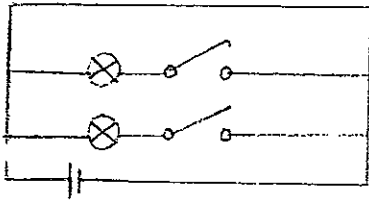

38)a)The water level in the tube would rise. The coloured water in the glass jar gained heat and expanded.

b)Air expands more than water when it gained heat.

39)a)She added the number of coils around the iron rod.

b)Material B. The difference between the number of iron nails that is attracted and retained on the electromagnet when it was turned off was the greatest.

c)No. Iron ,steel, nickel are magnetic metals and can be attracted by magnet and separated into bin C. Copper is a non-magnetic so it cannot be attracted by magnet and separated into bin C.

