



Anglo-Chinese School (Primary)

END-OF-YEAR EXAMINATION 2013
SCIENCE
PRIMARY FIVE
BOOKLET A

Name: _____ ()

Class: Primary 5 ____

Date: 28 October 2013

Duration of paper: 1h 45 min

INSTRUCTIONS TO CANDIDATES

1. This question paper consists of 25 printed pages including this cover page.
2. Do not turn this page until you are told to do so.
3. Follow all instructions carefully.
4. Answer all the questions in this booklet.
5. Shade your answer on the Optical Answer Sheet (OAS) provided.

For each question from 1 to 30, four options are given. One of them is the correct answer.

Make your choice and shade the correct oval (1, 2, 3 or 4) on the Optical Answer Sheet.

(60 marks)

1 In the table below, P, Q and R represent the characteristics of some animals.

A tick (✓) indicates that the animals listed in the table below have the characteristic(s).

Characteristics \ Animals	P	Q	R
Cockroach	✓		✓
Frog		✓	✓
Grasshopper	✓		✓

Which of the following best represent the headings for P, Q and R?

	P	Q	R
(1)	Has six legs	Lay eggs in water	Has a 3-stage life cycle
(2)	Has a 3-stage life cycle	Lay eggs in water	Has six legs
(3)	Has a 4-stage life cycle	Has six legs	Lay eggs in water
(4)	Has six legs	Has a 4-stage life cycle	Lay eggs in water

(Go on to the next page)

- 2 A syringe was connected to a glass jar as shown in the diagram below. The capacity of the jar is 300 cm^3 . The jar contained 250 cm^3 of water and the syringe contained 10 cm^3 of air.

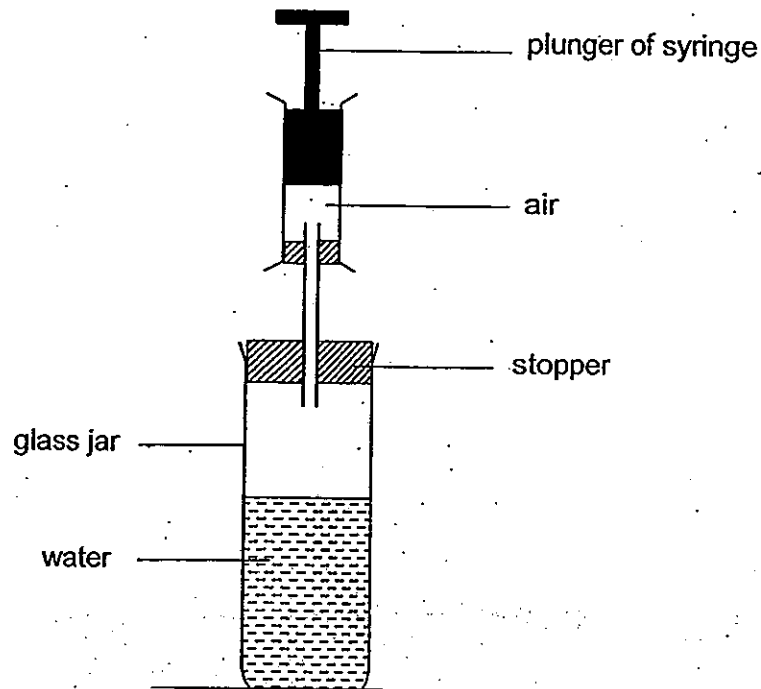

When the plunger of the syringe was pushed in completely, 10 cm^3 of air was forced into the jar. What was the volume of air in the jar after the plunger of the syringe had been pushed in completely?

- (1) 10 cm^3
- (2) 50 cm^3
- (3) 260 cm^3
- (4) 300 cm^3

- 3 A torch was shone at three objects hanging by strings as shown in the diagram below.

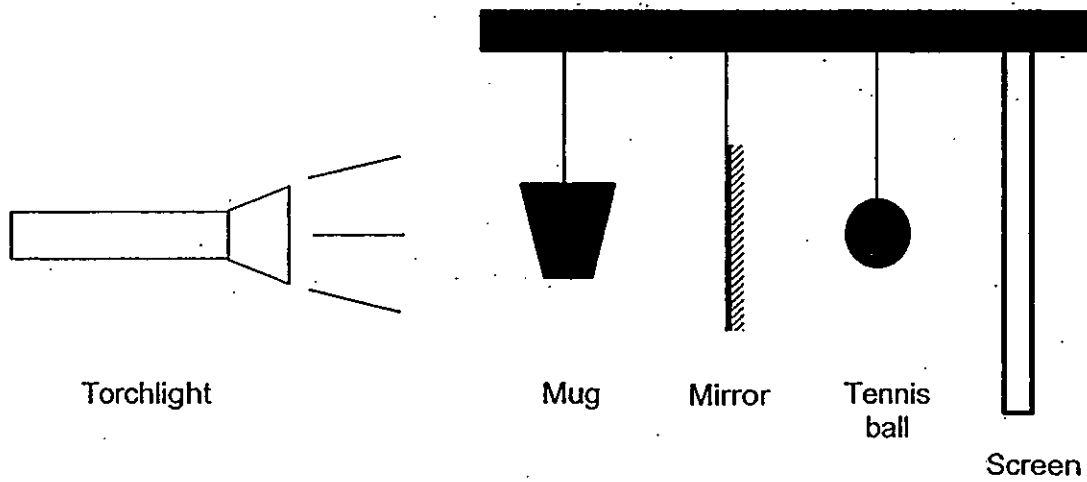

Which one of the following shadows will most likely be formed on the screen?

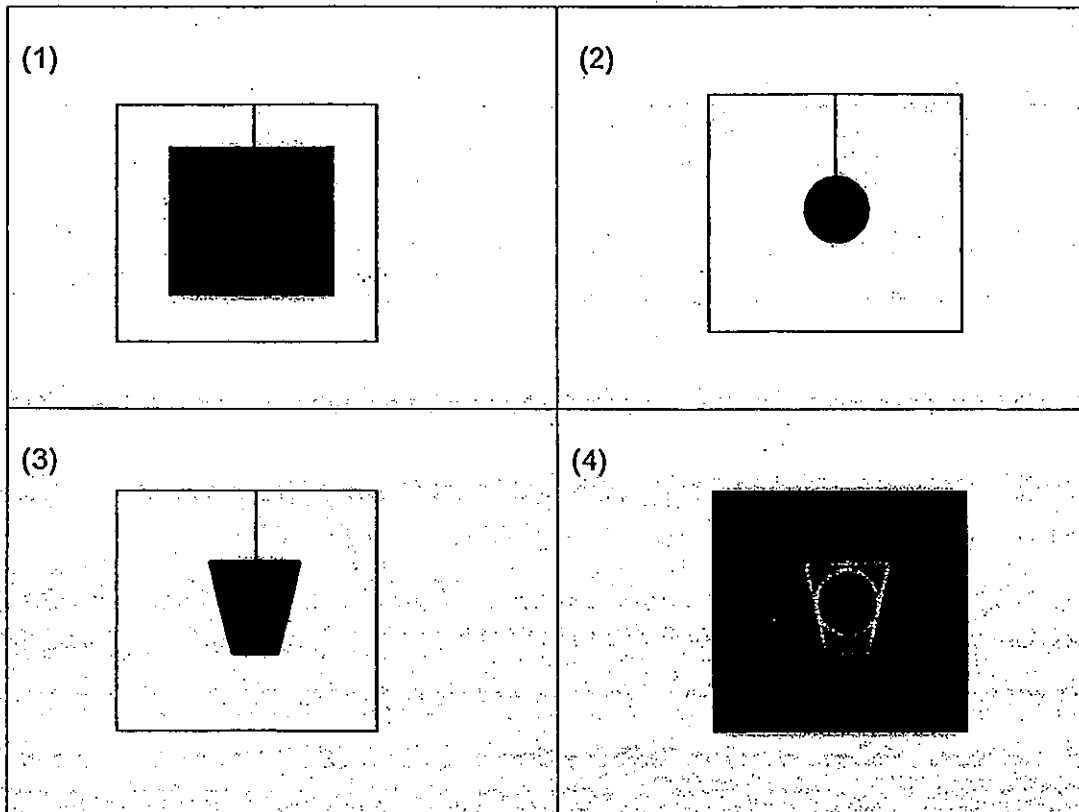

4 Study the circuit diagram below.

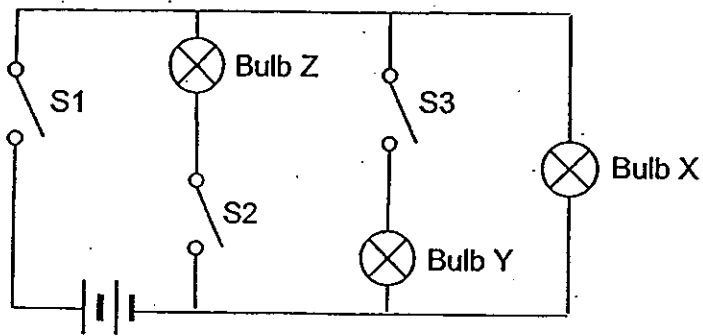

In which order must the switches be closed so that Bulb X lights up first, followed by Bulb Y and then Bulb Z?

	First	Second	Third
(1)	S1	S2	S3
(2)	S2	S3	S1
(3)	S3	S2	S1
(4)	S1	S3	S2

- 5 The electric circuit in the diagram below consists of two identical bulbs and four identical batteries. At first, Bulb A was unlit while Bulb B was lit with a brightness of 10 units. When the button is pushed downwards as shown by the arrow, the metal lever moves upwards to touch metal pin X.

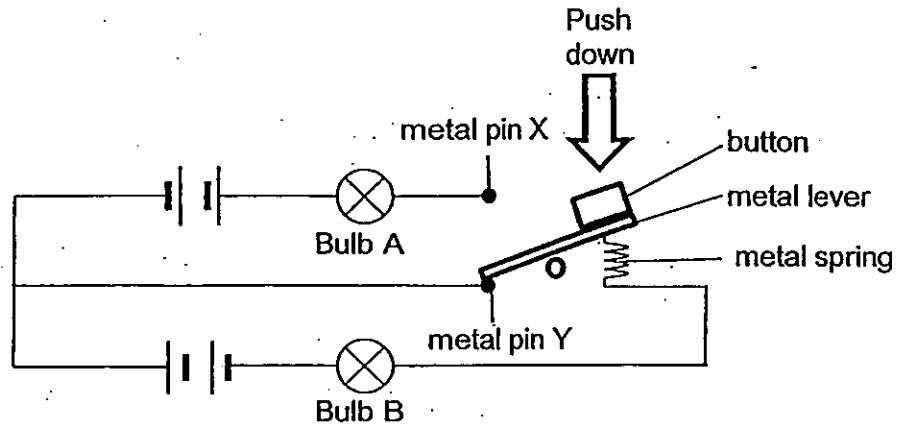

How much would Bulb A and B be lit when the button is pushed down?

	Bulb A	Bulb B
(1)	Brighter than 10 units	Brighter than 10 units
(2)	0 unit	0 unit
(3)	10 units	10 units
(4)	10 units	0 unit

- 6 Terry set up an electric circuit as shown in the diagram below. He connected three different objects, A, B and C, each made from a different material but of the same size. The objects were connected, one at a time, at the points P and Q, and left in the circuit for 20 minutes each.

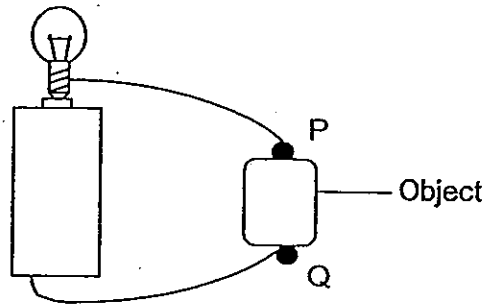

The table below shows the observations he made.

Object	Did the bulb light up?	Was the object hot?
A	Yes	No
B	No	No
C	Yes	Yes

Based on the observations above, Terry made some conclusions. Which one of the following conclusions is most likely to be correct?

- (1) Object A is an insulator of electricity.
- (2) Object B is a conductor of electricity.
- (3) Object C gives off less heat than Object A.
- (4) Objects A and C are conductors of electricity.

- 7 The table below shows whether a specific part of a cell is present or absent in three different types of cells, P, Q and R.

A tick (✓) indicates that the specific part of a cell listed in the table below is present in that type of cell.

Cell part \ Cell type	Nucleus	Cell Wall	Chloroplasts	Cell Membrane
P	✓	✓		✓
Q	✓	✓	✓	✓
R	✓			✓

Based on the information from the table above only, which of the following statement(s) about P, Q and R is/are true?

- A Q is most likely a plant cell.
- B P is most likely an animal cell.
- C R may be found in the leaf of a plant.

- (1) A only
- (2) C only
- (3) A and B only
- (4) B and C only

- 8 Which of the following statement(s) about the respiratory system is/are correct?

- A The nose hairs trap dust.
- B The respiratory system helps to remove carbon dioxide from the body.
- C The main organs in the respiratory system consist of the nose, gullet, lungs, and diaphragm.

- (1) A only
- (2) A and B only
- (3) B and C only
- (4) A, B and C

- 9 The diagrams below show the parts of two different cells, A and B.

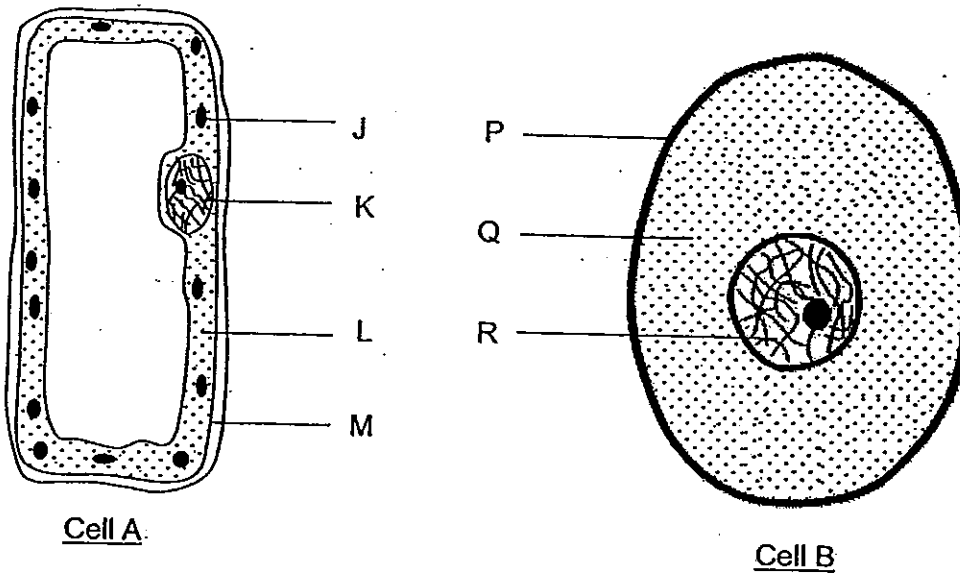

Which parts of the cells are correctly matched to their functions?

	Parts	Functions
(1)	M and P	Give the cells their regular shape.
(2)	J and P	Control all the activities in the cells.
(3)	L and Q	Jelly-like substance where most cell activities take place.
(4)	K and R	Control the movement of substances in and out of the cells.

10 The table below shows the comparison between sexual reproduction in flowering plants and humans.

	Flowering Plants	Humans
Male reproductive cell	W	Y
Female reproductive cell	X	Z

Which of the following correctly represent W, X, Y and Z?

	W	X	Y	Z
(1)	sperm	ovule	pollen grain	womb
(2)	anther	stigma	sperm	egg
(3)	pollen grain	ovule	sperm	egg
(4)	pollen grain	style	anther	womb

11 The diagrams below show the male and female reproductive parts of a human.

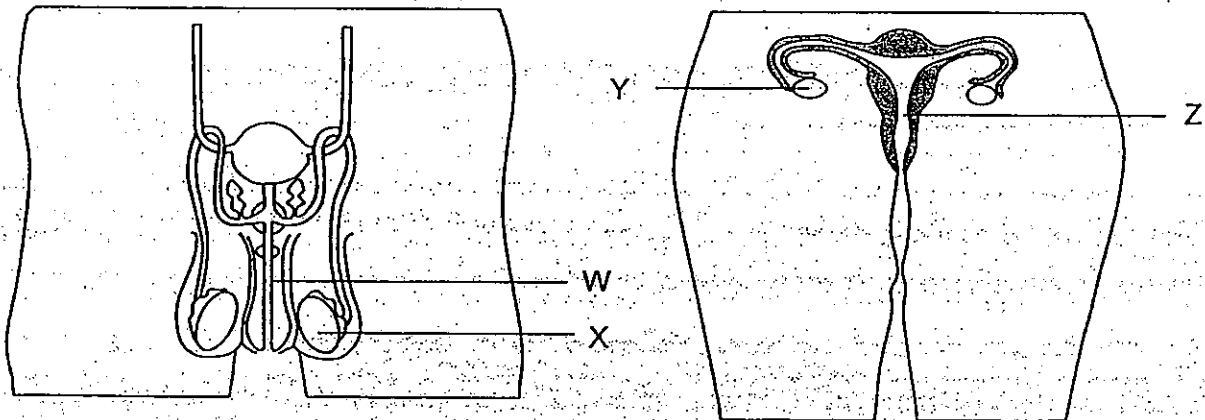

Which parts of the systems produce the reproductive sex cells?

- (1) W and Y only
- (2) W and Z only
- (3) X and Y only
- (4) X and Z only

- 12 Study the family tree of the Lee family below. A brief description of the physical characteristics of the different family members is given.

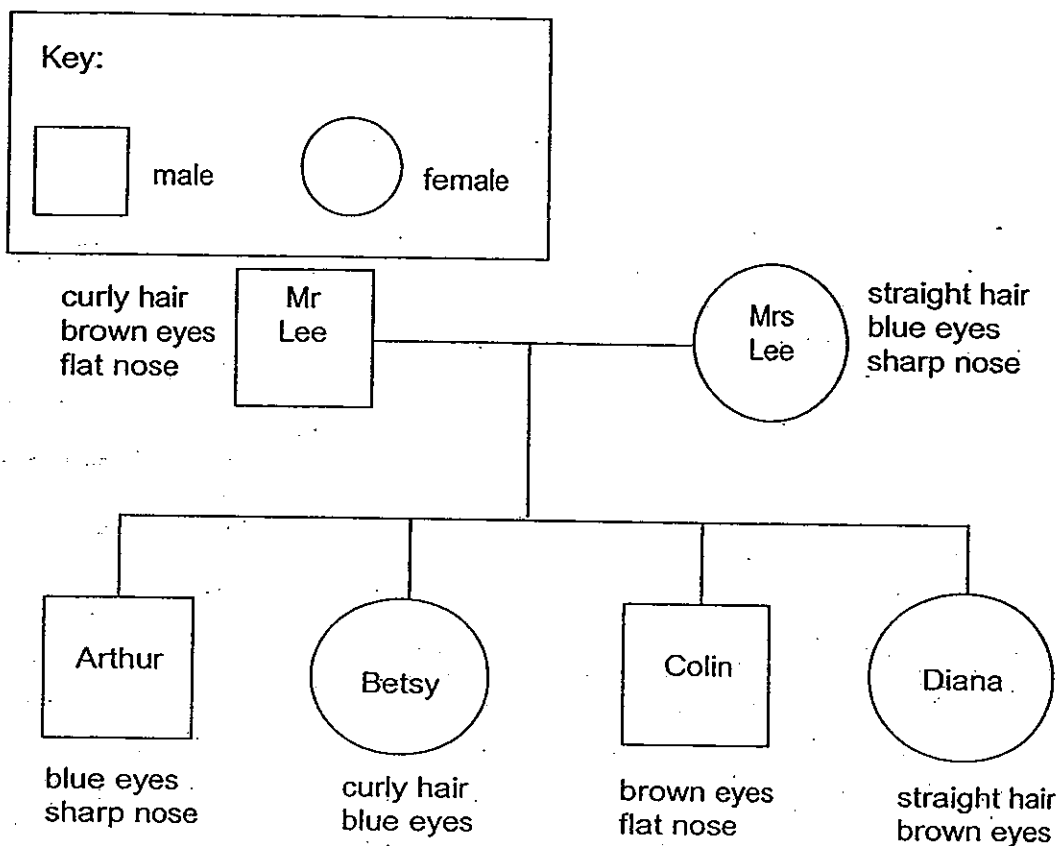

Based on the information above, which of the four children inherited exactly two characteristics from one of their parents?

- (1) Betsy and Diana only
 - (2) Arthur and Betsy only
 - (3) Arthur and Colin only
 - (4) Arthur, Betsy, Colin and Diana
- 13 Which of the following characteristics can be passed down from parents to their young?
- A Fingerprint
 - B Length of hair
 - C Attached earlobes
 - D Tongue-rolling ability
- (1) A and B only
 - (2) C and D only
 - (3) B, C and D only
 - (4) All of the above

- 14 The diagrams below show a part of the human respiratory system, P, and a part of the underside of a leaf, Q.

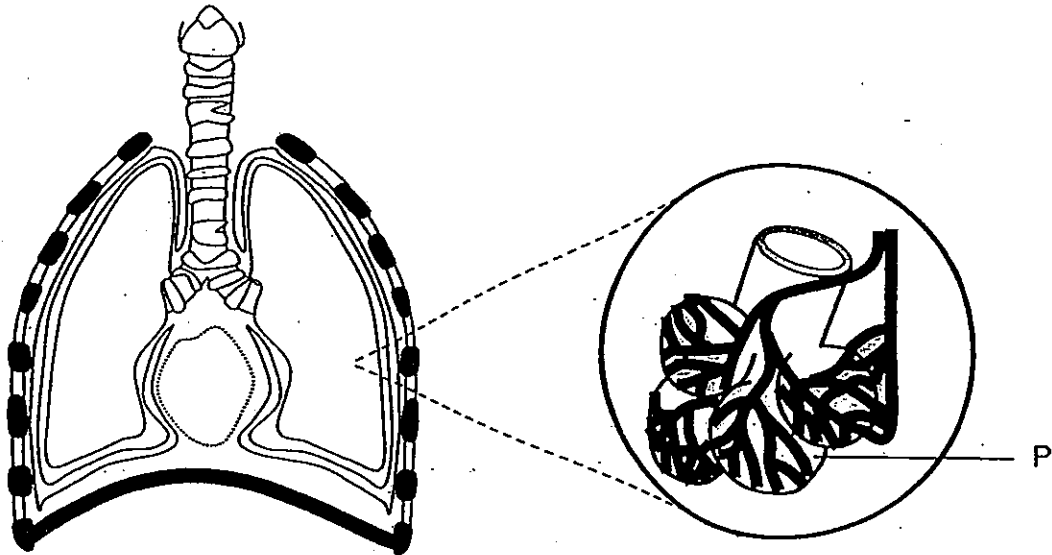

Human respiratory system

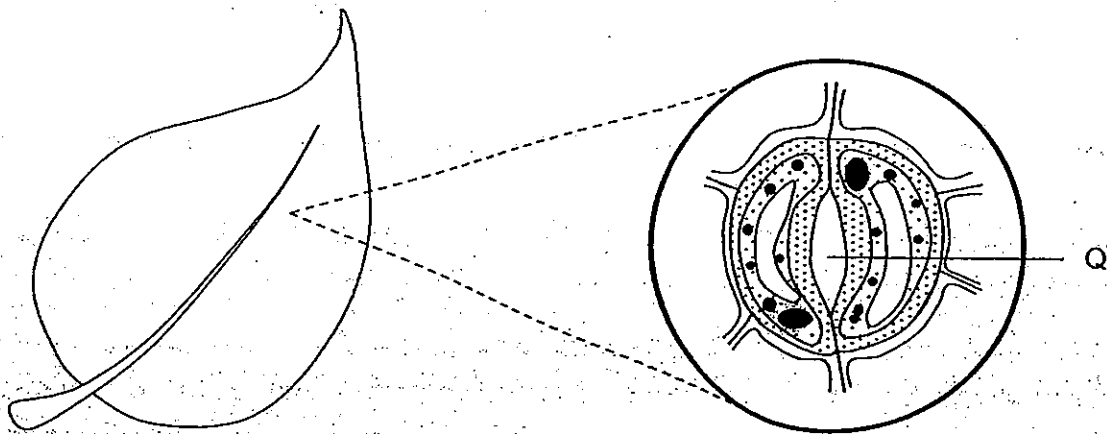

Underside of a leaf

Based on the diagrams above, which of the following statement(s) about P and Q is/are true?

- A Air is stored in P and Q.
 - B Q makes food for the plant.
 - C Gaseous exchange occurs at P and Q.
- (1) A only
 (2) C only
 (3) A and B only
 (4) B and C only

- 15 Raphael recorded his breathing rate while he was at rest for five minutes. He then started to run for five minutes. He then stopped running and rested for five minutes. His breathing rate was continuously measured for an entire 15 minutes.

Which one of the following graphs most likely represents a change in his breathing rate before, during and after the run?

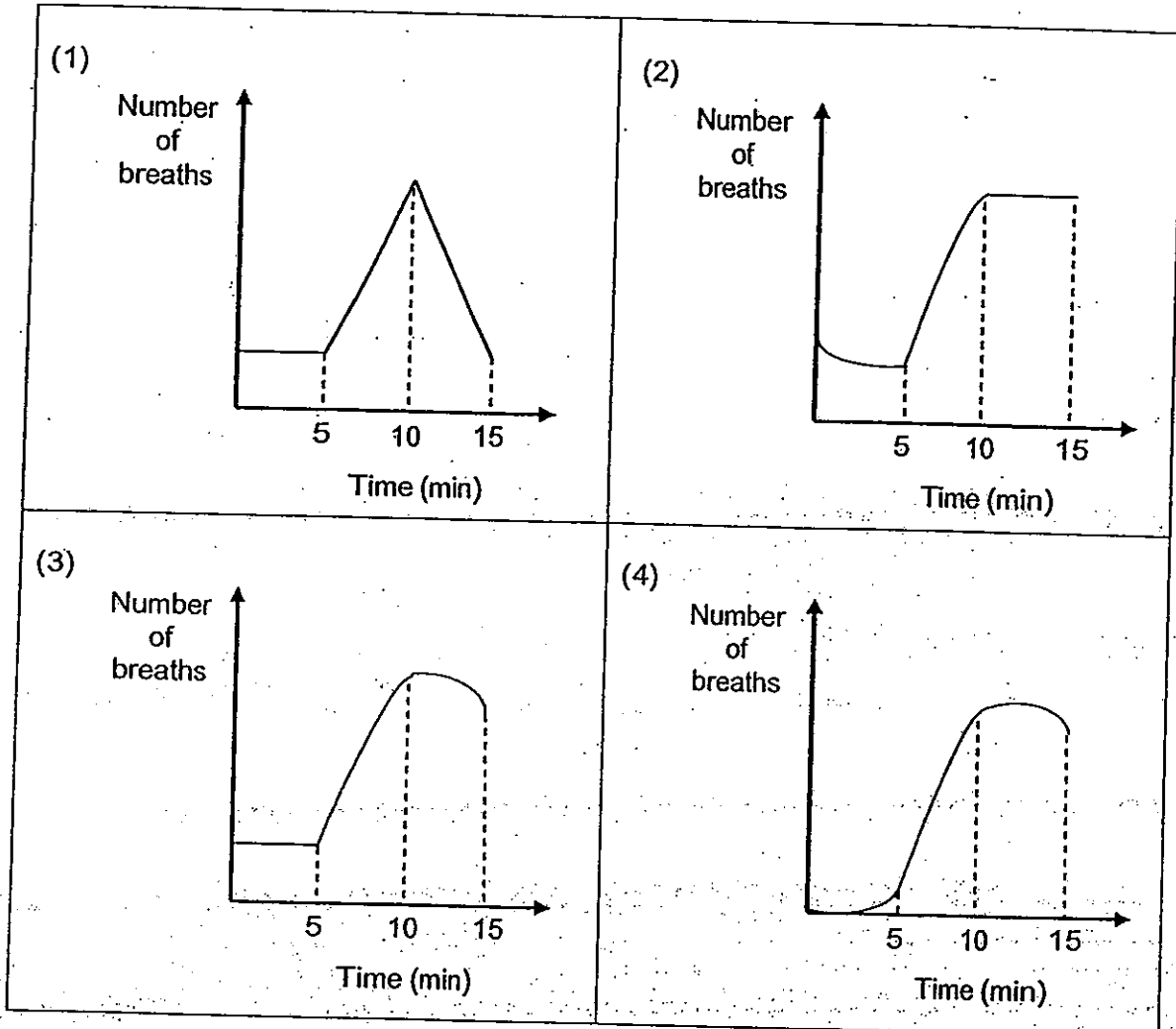

16 The diagram below is a picture of a car. Different parts of the car are made of different material.

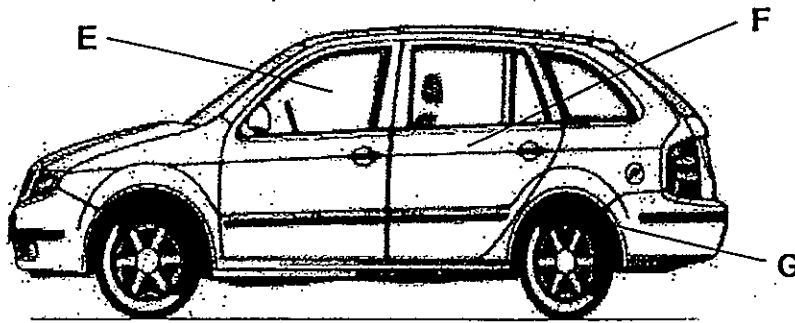

Which one of the following materials are best suited for making parts E, F and G of the car?

	E	F	G
(1)	Metal	Glass	Rubber
(2)	Glass	Rubber	Metal
(3)	Glass	Metal	Rubber
(4)	Rubber	Glass	Metal

17 Study the pictures of the leaves below.



Leaf A



Leaf B

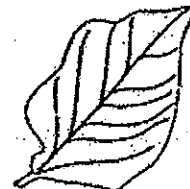

Leaf C

Four students made comments about the leaves.

Alex: Each of them has a leaf stalk.

Bobby: Leaf A and Leaf C have network veins, but not Leaf B.

Charlie: Leaf B is narrow in width while Leaf A and C are not.

Danny: They have entire edges.

Which students had made the right comments?

- (1) Alex and Charlie only
- (2) Alex and Danny only
- (3) Alex, Bobby and Charlie only
- (4) Alex, Bobby, Charlie and Danny

18 Study the pictures below.



eagle



housefly



wasp



ostrich

Based on the observation of the diagrams and your knowledge about them, what are the common characteristics of the four living organisms?

- A All of them can fly.
- B All of them have wings.
- C All of them reproduce by laying eggs.

- (1) B only
- (2) A and C only
- (3) B and C only
- (4) A, B and C only

19 Which of the following processes take place at a constant temperature?

- A Boiling
- B Melting
- C Freezing
- D Evaporation
- E Condensation

- (1) D and E only
- (2) A, B and C only
- (3) B, C and D only
- (4) None of the above

(Go on to the next page)

20 Which of these statements about the evaporation and boiling of pure water are correct under normal conditions?

- A Boiling requires heat while evaporation does not.
- B Boiling produces steam while evaporation produces water vapour.
- C Evaporation rate is affected by the exposed surface area of water while boiling rate is not.
- D Evaporation can take place at room temperature while boiling can only take place at 100°C.

- (1) A and B only
- (2) C and D only
- (3) B, C and D only
- (4) All of the above

- 21 The diagram below shows that roots of the plant hold on to the soil firmly. By doing so, it reduces the amount of soil being washed off a slope when it rains.

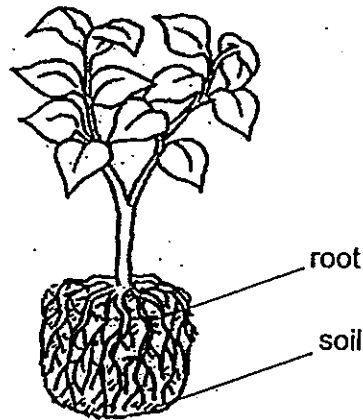

Alex carried out an experiment to find out if the roots of the plant reduce the amount of soil being washed off a slope. At the start, 1000 g of soil was placed in three identical trays slanted at an angle. Five plants without roots were planted in set-up B while five plants with roots were planted in set-up C. All plants were of the same type and height.

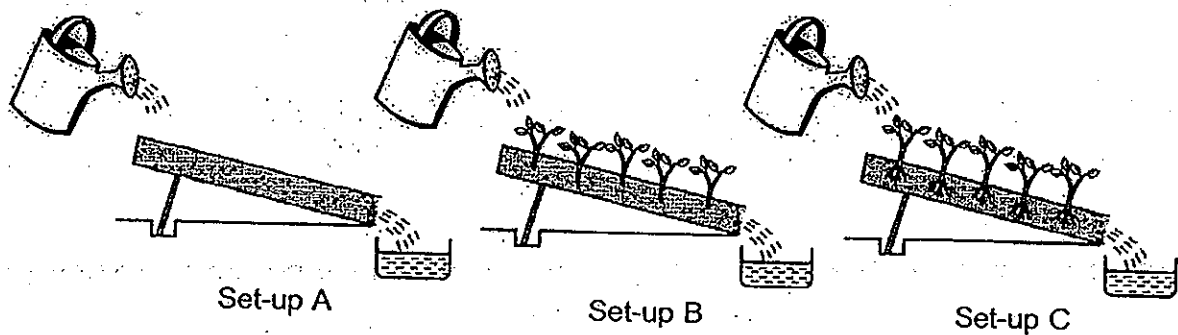

Equal amounts of water was poured onto the set-ups as shown above. The amount of soil left in each tray is dried and weighed. Predict the amount of soil left in the tray at the end of the experiment for each set-up.

	Amount of soil left in set up A (g)	Amount of soil left in set up B (g)	Amount of soil left in set up C (g)
(1)	710	950	740
(2)	700	750	950
(3)	980	760	980
(4)	950	950	760

(Go on to the next page)

22 Steven wanted to conduct an experiment to find out how different types of soil affect the rate at which water seeps through them when it rains. He set up the experiment as shown below and poured 100 ml of water to the different soil and measured the amount of water collected in the beaker after 30 minutes.

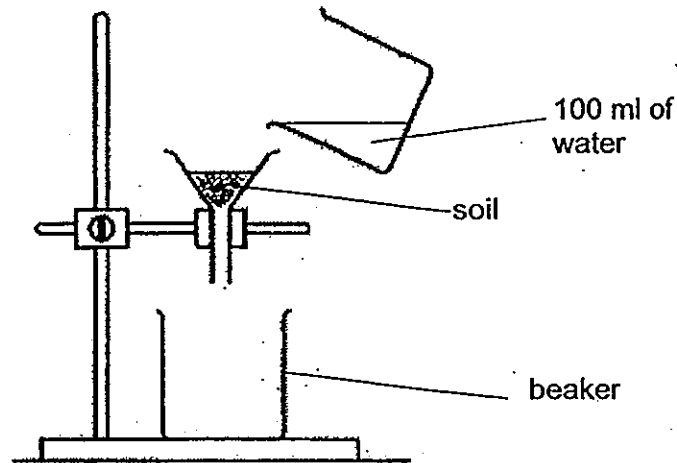

The result was recorded in the table below.

Type of Soil	Amount of water collected in the beaker after 30 minutes (ml)
A	75
B	33
C	58
D	90

Which soil, A, B, C or D, is the worst at slowing down the rate of water seeping through it?

- (1) A
- (2) B
- (3) C
- (4) D

- 23 The line graph below shows the change in population size of organism P over a period of four months. The number of organism P at the beginning was 600.

Number of organism P

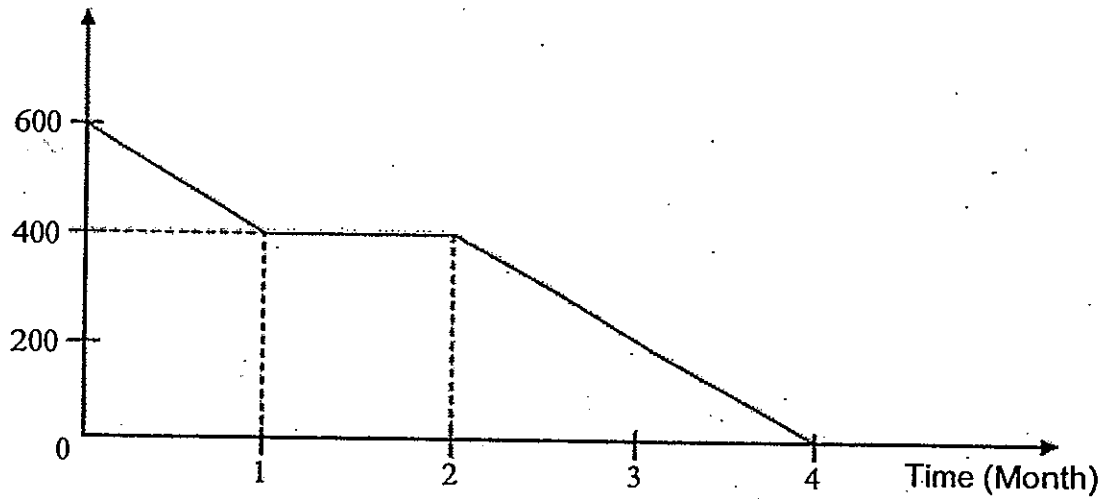

Based on the graph only, which one of the following statements is correct?

- (1) The number of P decreased every month.
- (2) The number of P remained the same for a month.
- (3) The whole population of P died eventually due to a disease.
- (4) The highest number of P was recorded at the end of the first month.

- 24 The diagram below represents the similarities and differences of the tubes found in a plant transport system.

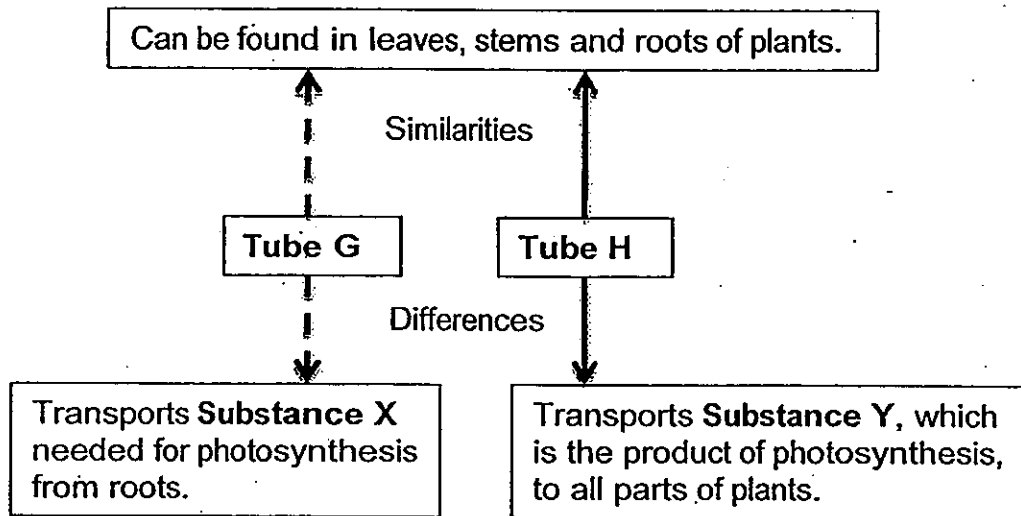

Which one of the following correctly identifies G, H, X and Y?

	Tube		Substance	
	G	H	X	Y
(1)	food-carrying	water-carrying	food	water
(2)	water-carrying	food-carrying	food	water
(3)	food-carrying	water-carrying	water	food
(4)	water-carrying	food-carrying	water	food

- 25 Two identical plants with white flowers were placed in a beaker of water mixed with blue dye each as shown in the diagram below. The leaves of the plant in set up Y were removed while the plant in set up X has leaves. Both set ups were placed under the sun.

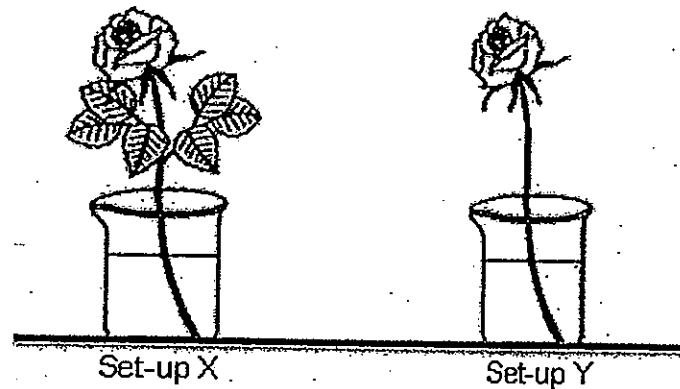

It was observed that both flowers turned blue. However, the flower in set-up X turns blue faster than the flower in set-up Y. What can you infer from this observation?

- A The stem only transports water to the leaves.
- B The water travel up the stems of the plant to the flower.
- C The presence of leaves speeds up the transportation of water in plants.
- D The presence of leaves does not affect the transportation of water in plants

- (1) A and C only
- (2) A and D only
- (3) B and C only
- (4) B and D only

26 Lance wanted to find out what will happen when the food-carrying tubes have been removed from a section of the stem. He set up the experiment as shown below and carefully removed a ring of stem so that only the food-carrying tubes were removed. He left the plant near an open window for five days.

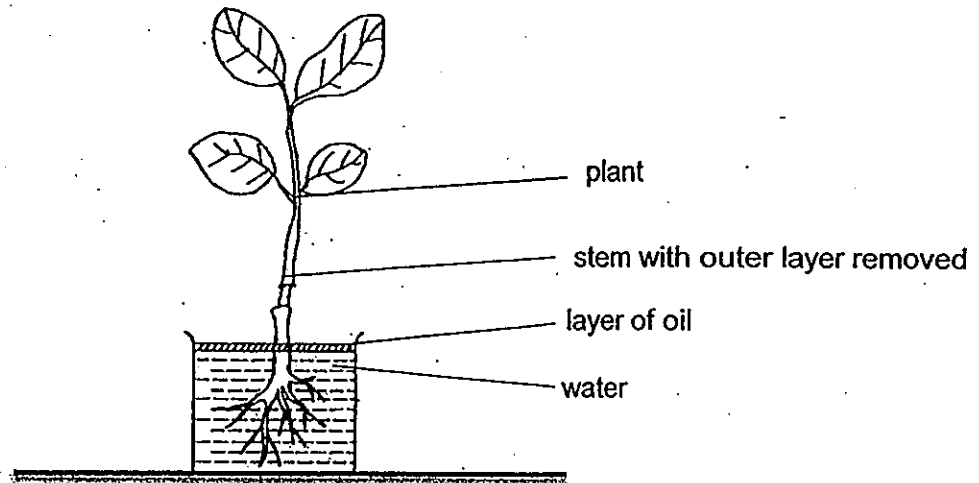

Predict what Lance will observe at the stem five days later.

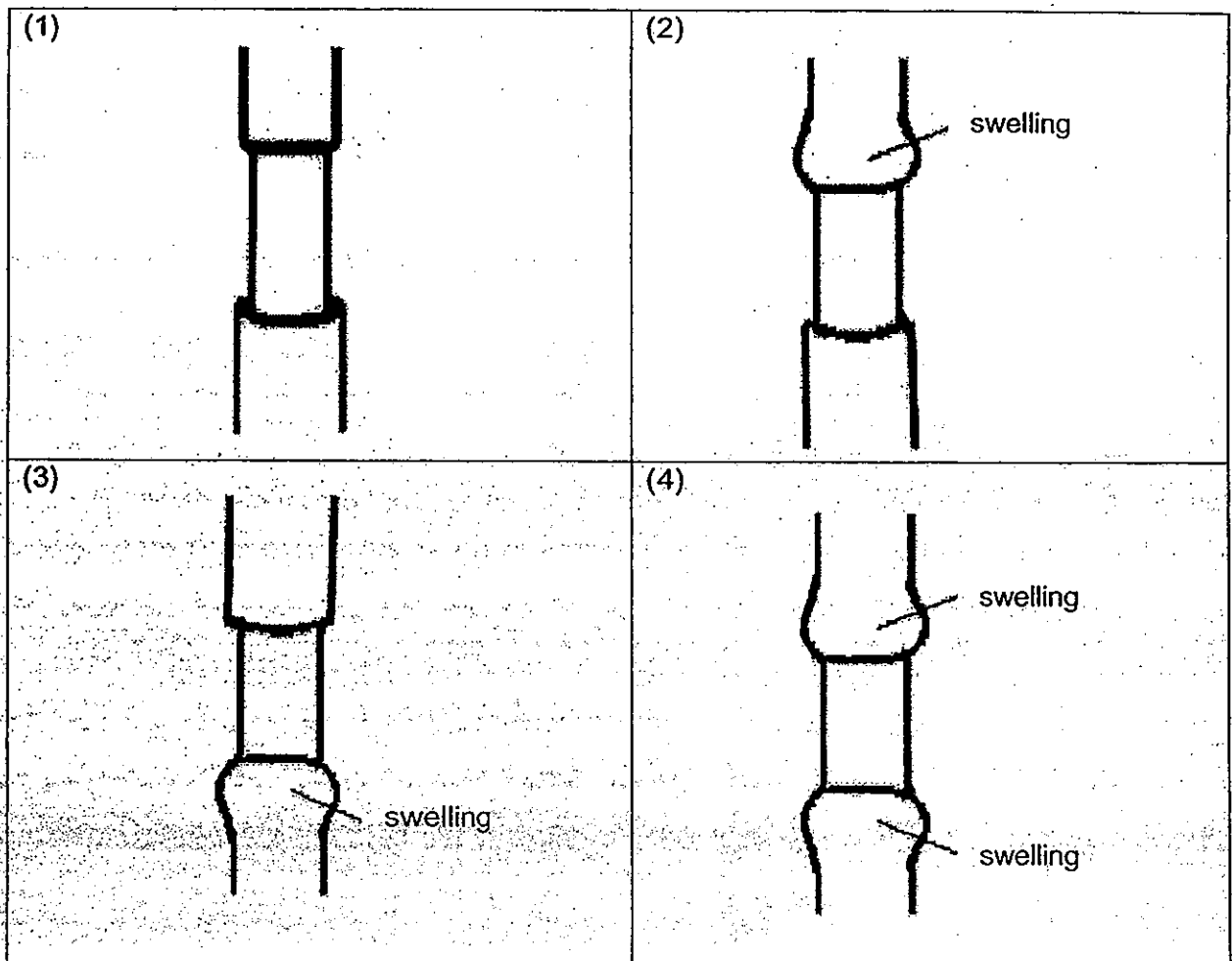

(Go on to the next page)

27 Observe the fruits below. Based on their characteristics that you can observe, identify their method of seed dispersal.

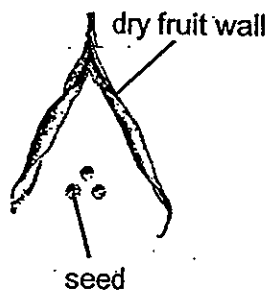

Fruit A

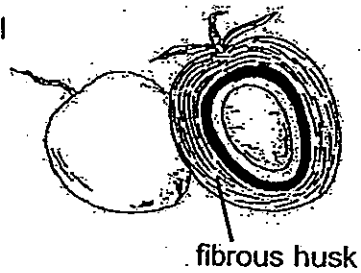

Fruit B

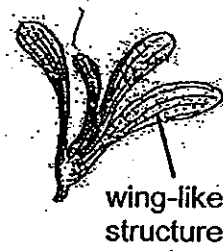

Fruit C

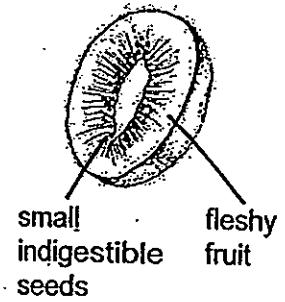

Fruit D

Seeds are dispersed by:				
	Animals	Water	Splitting	Wind
(1)	A	C	B	D
(2)	A	B	D	C
(3)	B	C	A	D
(4)	D	B	A	C

28 James placed an equal number of similar seeds into four dishes (P, Q, R and S). Each dish was exposed to different conditions as shown in the table below. A tick (✓) indicates the presence of the condition.

Dish	Conditions			
	Water	Air	Light	Temperature (°C)
P	✓		✓	30
Q	✓	✓	✓	0
R	✓	✓		30
S		✓	✓	0

In which of the dishes will the seeds germinate?

- (1) P
- (2) Q
- (3) R
- (4) S

(Go on to the next page)

29 The diagram below shows the cross-section of a flower.

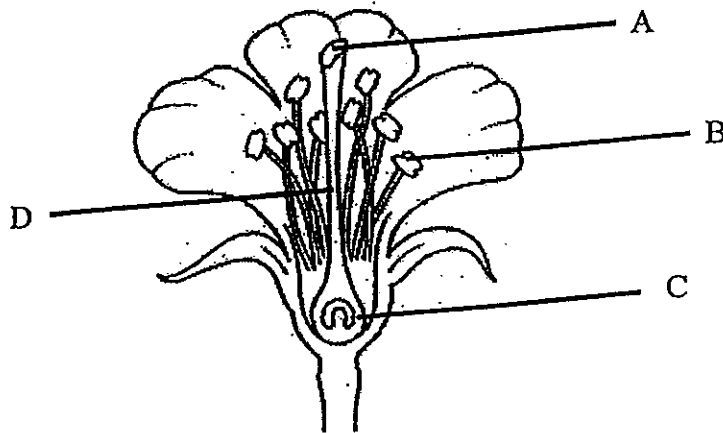

Which is the correct label for the parts A, B, C and D?

	A	B	C	D
(1)	Anther	Stigma	Style	Ovary
(2)	Ovary	Style	Anther	Stigma
(3)	Stigma	Anther	Ovary	Style
(4)	Ovary	Style	Stigma	Anther

(Go on to the next page)

30 Study the flowchart below. It describes the general characteristic of the flowers that are pollinated by different animals.

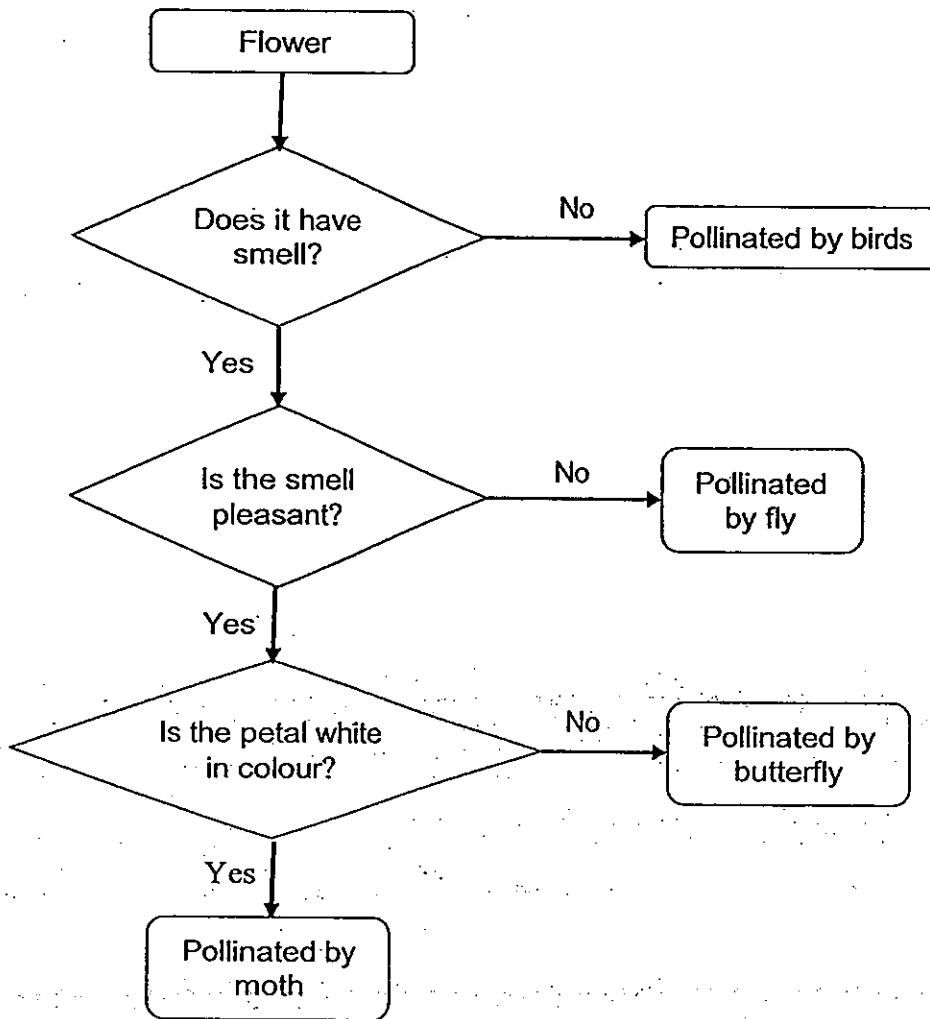

Plant X has flowers with white petals and sweet fragrance.

Which animal is most likely to pollinate the flowers of plant X?

- (1) Fly
- (2) Bird
- (3) Moth
- (4) Butterfly

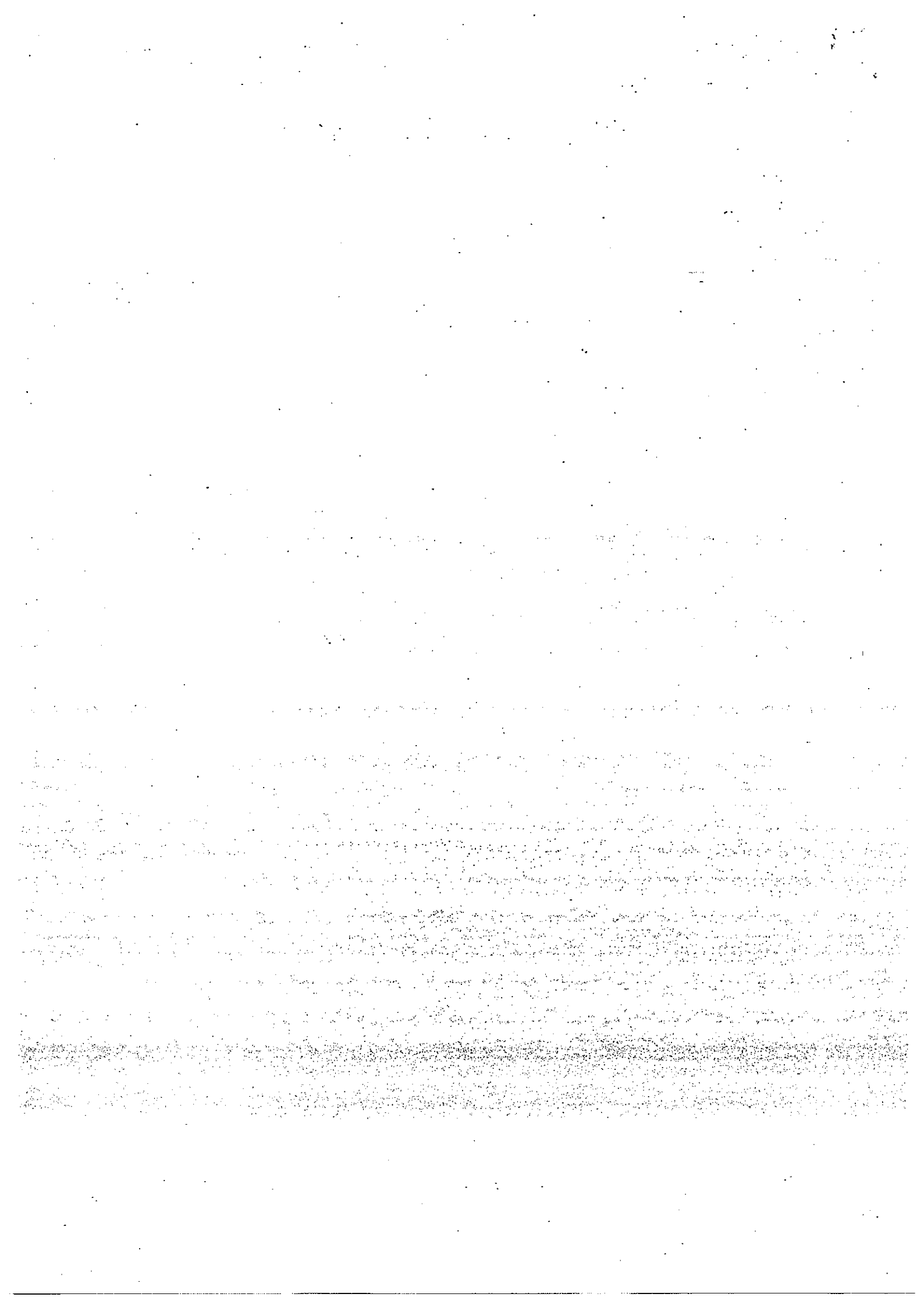



Anglo-Chinese School (Primary)

END-OF-YEAR EXAMINATION 2013
SCIENCE
PRIMARY FIVE
BOOKLET B

Name: _____ ()

Class: Primary 5 _____

Date: 28 October 2013

INSTRUCTIONS TO CANDIDATES

1. This question paper consists of 16 printed pages including this cover page.
2. Do not turn this page until you are told to do so.
3. Follow all instructions carefully.
4. Answer all the questions in this booklet.

BOOKLET	MAXIMUM MARKS	MARKS OBTAINED
A	60	
B	40	
Total	100	

For questions 31 to 44, write your answers in the spaces provided.

The number of marks available is shown in brackets [] at the end of each question or part question.

(40 marks)

31 Ronald found two identical glasses that are stuck together as shown in the diagram below.

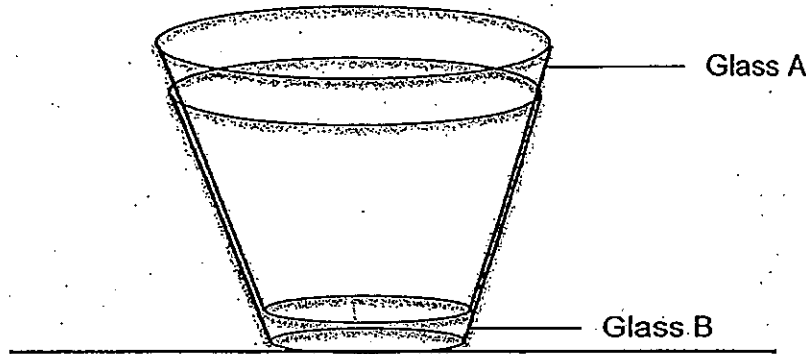

(a) Describe what Ronald can do to separate the two glasses without breaking them. [1]

(b) Explain your answer in (a). [1]

Once the two glasses were separated, Ronald then used the two glasses, A and B, to conduct another experiment to study the difference between heat and temperature. The table below provides the details of the set-ups that he used for his experiment.

Variables \ Set-up	Glass A	Glass B
Volume of water (ml)	200	100
Temperature of water ($^{\circ}\text{C}$)	70°C	70°C
Temperature of surrounding ($^{\circ}\text{C}$)	30°C	30°C

(Go on to the next page)

Score	2
-------	---

- (c) Ronald predicted that the two glasses of water will cool down at the same rate since both of them were filled with water of the same temperature.

Do you agree? Explain your answer.

[2]

(Go on to the next page)

Score	2
-------	---

- 32 Samuel set up an experiment as shown in the diagram below to find out which liquids conduct electricity.

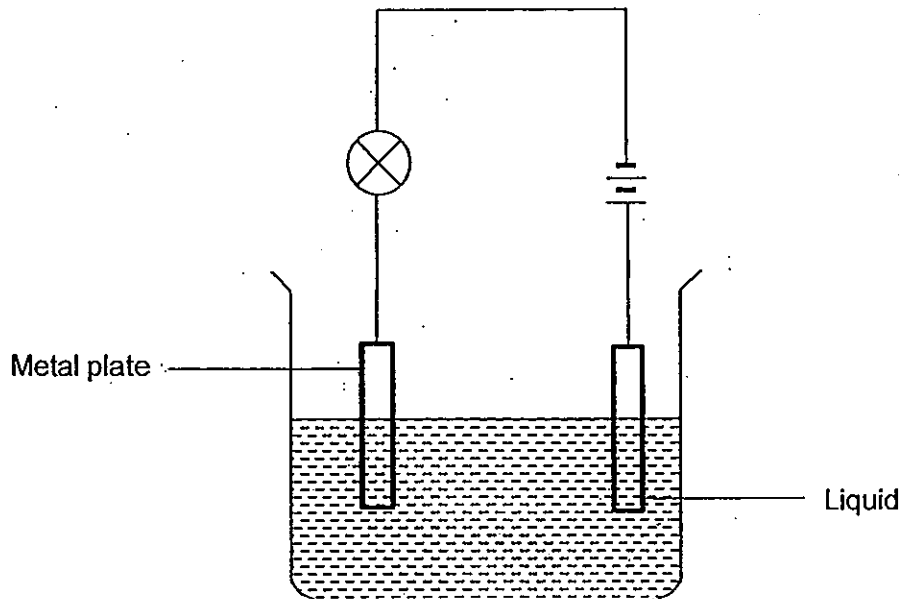

A similar set-up was used every time a new liquid was tested. He recorded whether the bulb lit up in the table shown below.

Liquids	Did the bulb light up?
Vinegar	Yes
Seawater	Yes
Pure water	No
Cooking oil	No

- (a) State one variable that must be kept constant so that the experiment is a fair one. [1]

- (b) Samuel inferred from his observation that vinegar is a better conductor of electricity than seawater. What could he have observed to make this inference? [1]

(Go on to the next page)

Score	2
-------	---

33 Three different types of rods, A, B and C, of the same size were placed in two electric circuits as shown in the diagrams below. One of the rods is an insulator of electricity. The bulbs in both circuits lit up.

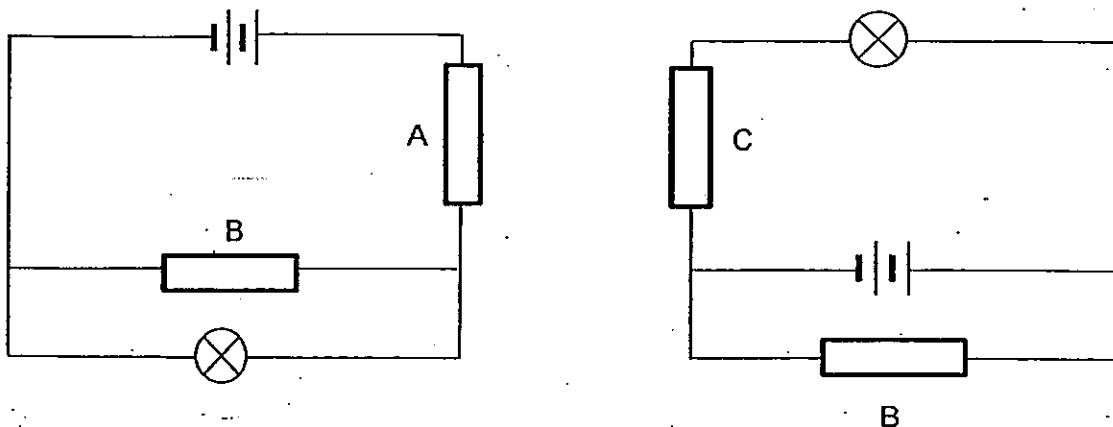

(a) Based on the diagrams above, which rod is an insulator of electricity? [1]

The three rods, A, B and C, were then placed at positions X, Y and Z in another electric circuit as shown below.

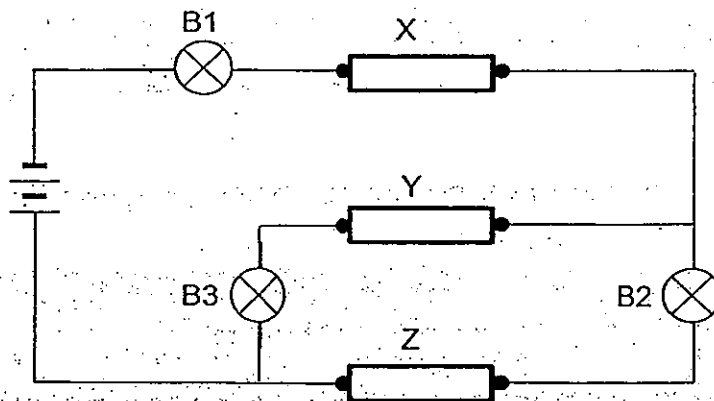

(b) Based on the diagram above, complete the table below. For each scenario, indicate which bulb(s) would light up by putting a tick (✓) in the correct box. [2]

Scenario	Positions where rods were placed			Bulb(s) that would light up		
	Position X	Position Y	Position Z	B1	B2	B3
1	A	B	C			
2	C	A	B			

(Go on to the next page)

Score	3
-------	---

- 34 The diagram below shows a germinating seed with its root growing out. After several days, the roots became longer.

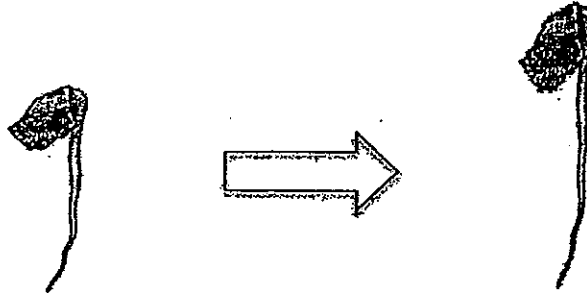

- (a) What happens to the cells in the root as the root grows in length? [1]

The diagram below shows the image of a root cell when observed under a microscope.

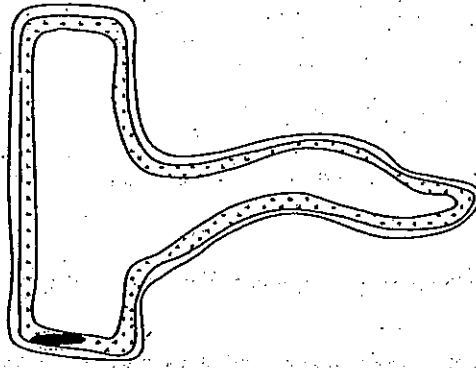

- (b) Which part of a plant cell is missing in the root cell that can be found in a green leaf cell? [1]

- (c) Explain why the cell part in (b) is not found in the root cell. [2]

(Go on to the next page)

Score	4
-------	---

35 The diagram below shows the family tree of Sally, Brenda and Sam.

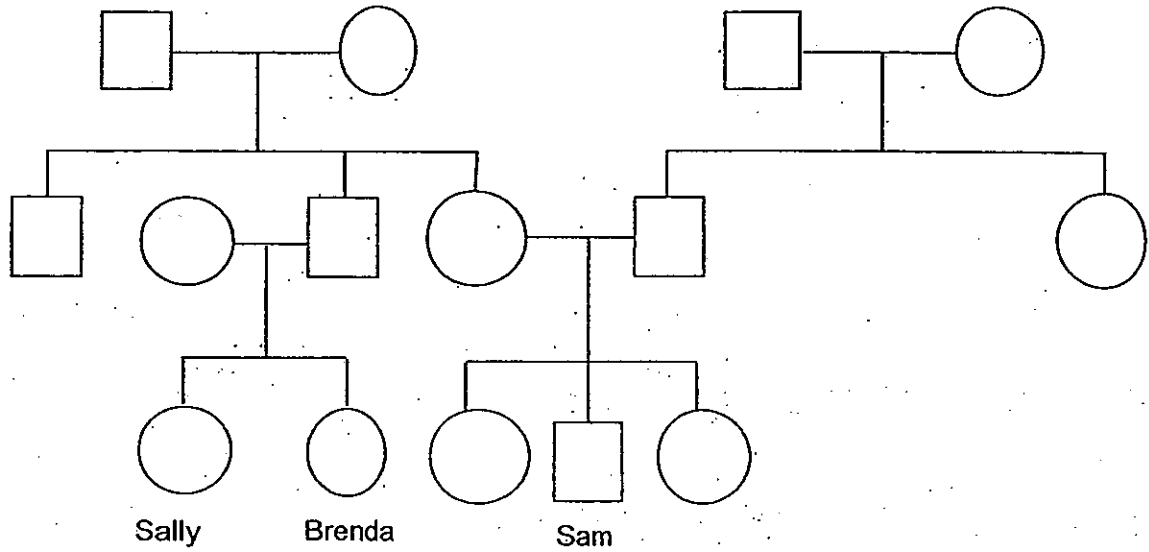
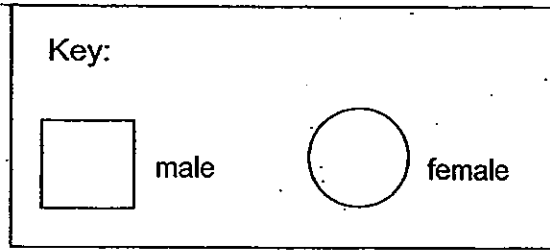

Based on the information above, put a tick (\checkmark) in the correct boxes to indicate whether the statements are True, False or Not possible to tell. [2]

	Statement	True	False	Not Possible to tell
(a)	Sam has two sisters.			
(b)	Brenda and Sally are twins.			
(c)	Sam's father has four nieces.			
(d)	Brenda's father and Sam's mother are siblings.			

(Go on to the next page)

Score	2
-------	---

36. The bar graphs below show the composition of inhaled and exhaled air.

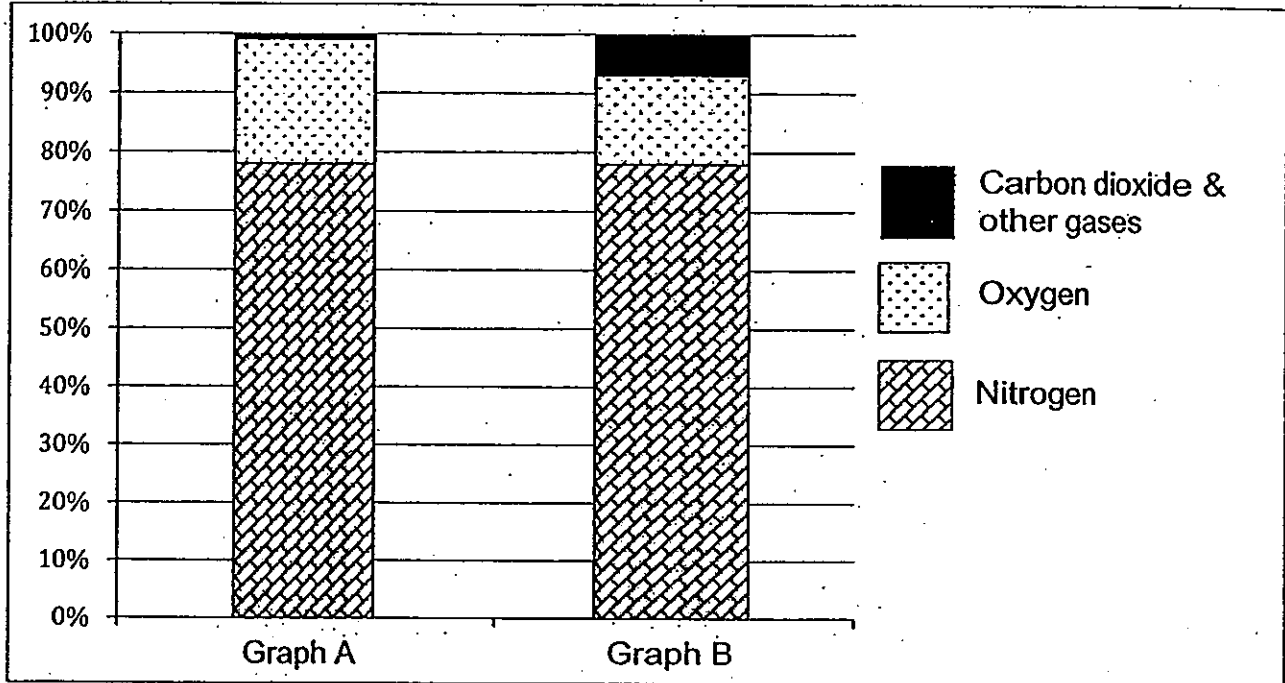

- (a) Which bar graph, A or B, best represents the composition of inhaled air? Explain your choice. [1]

- (b) Based on the graphs above, state one other difference between inhaled and exhaled air. [1]

- (c) There is a part of the skeletal system that provides protection to one important part of the respiratory system.

What is this part of the skeletal system and which organ does it protect? [2]

(Go on to the next page)

Score	4
-------	---

- 37 In Diagram 1, Rod A was tied to a string and the North Pole of a magnet is placed near it. Rod A moved away from the magnet as shown below.

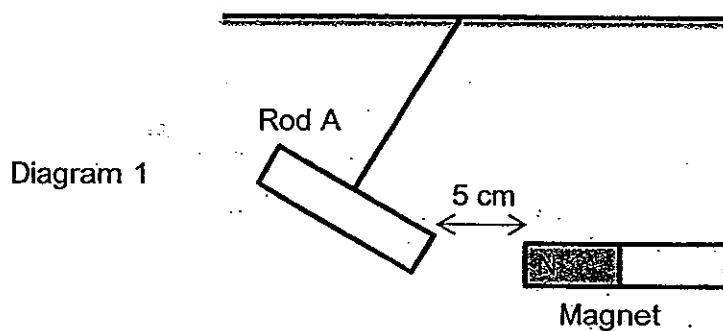

- (a) Based on the observation above, what material is Rod A made of? [1]

In Diagram 2, a flame is placed underneath Rod A and the North Pole of the same magnet is placed near it, however, this time the distance between Rod A and the magnet reduces.

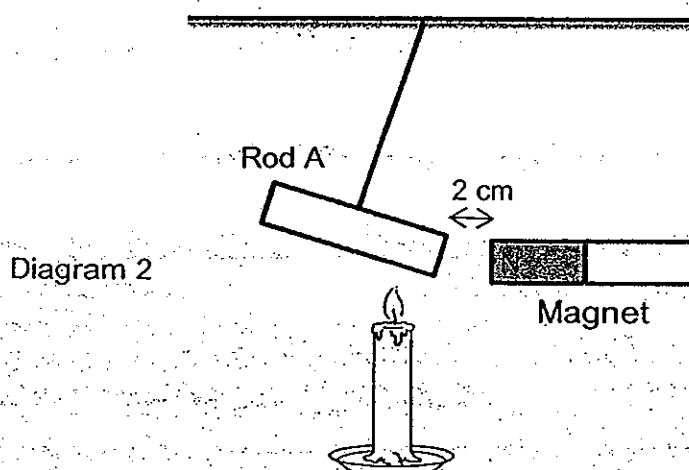

- (b) Explain the observation in diagram 2. [1]

(Go on to the next page)

Score	2
-------	---

- 38 The graph below shows the amount of digested food in the different part of the digestive system.

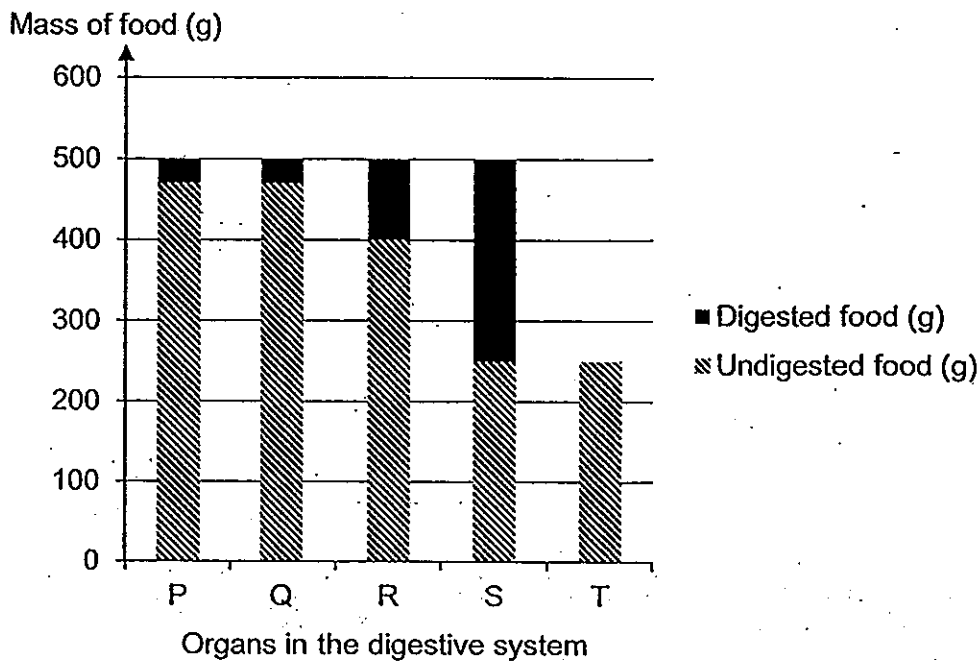

- (a) Based on the graph above, identify the organ(s) where digestion take(s) place by putting a tick (✓) in the correct box(es). [1]

Organs in the digestive system	Is there digestion taking place here?
Q	
R	
S	
T	

- (b) What are the two functions of the small intestine in the digestive system? [1]

(Go on to the next page)

Score	2
-------	---

- 39 Sean wanted to conduct an experiment to find out if the amount of exposed surface area affects the rate of evaporation. Three identical towels of the same size and materials, each containing the same amount of water, were left hanging out in the open as shown in the diagram below. Towel A is fully opened up, towel B is folded once and towel C is folded twice.

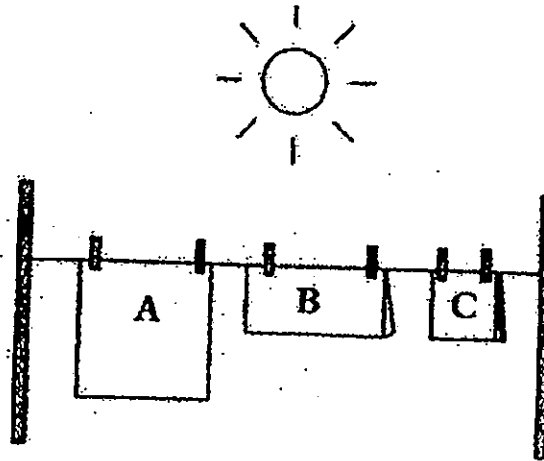

After three hours, towel A is completely dried, towel B is still wet while towel C is the wettest. Sean recorded the mass of each towel at the start of the experiment and at the end of it. The results are shown in the table below.

	Mass at the start of experiment (g)	Mass after three hours. (g)
Towel A	300	80
Towel B	300	190
Towel C	300	250

- (a) Based on the table above, what is the relationship between the exposed surface area and the rate of evaporation that Sean can infer from his experiment? [1]

- (b) Name two other factors that affect the rate of evaporation. [1]

- i. _____
- ii. _____

(Go on to the next page)

Score	2
-------	---

- 40 Jonathan prepared the two set-ups as shown below to demonstrate the formation of rain in the water cycle. The two lamps were switched on.

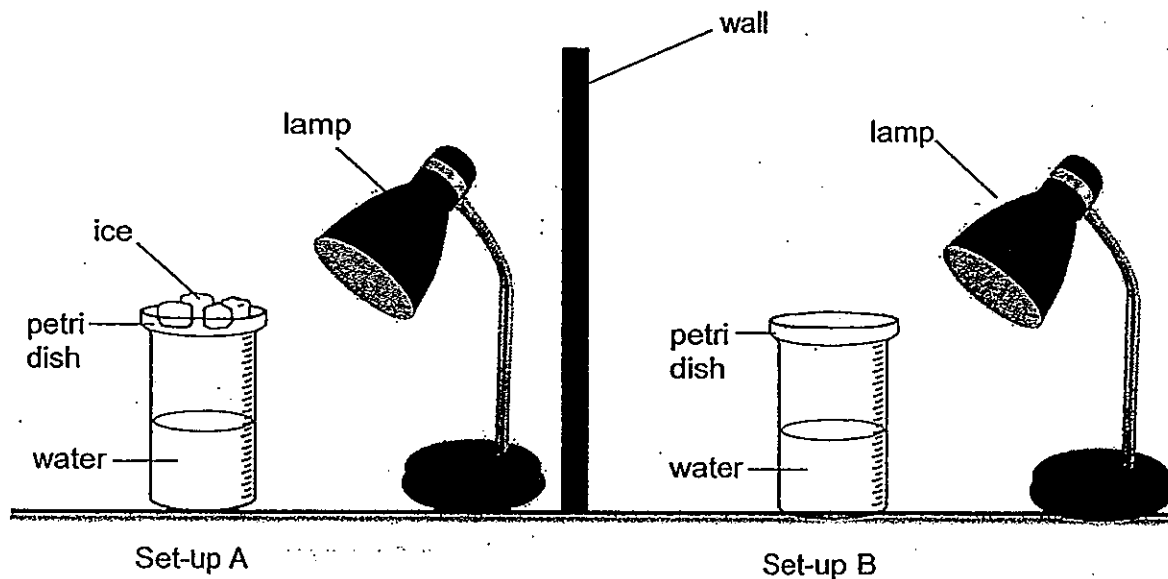

- (a) Water droplets were formed at the base of the petri dish in set-up A. Give an explanation for this observation. [2]

- (b) There were no water droplets formed at the base of the petri dish in set-up B. Give an explanation for this observation. [1]

(Go on to the next page)

Score	3
-------	---

41 The diagram below is a picture of a pond.

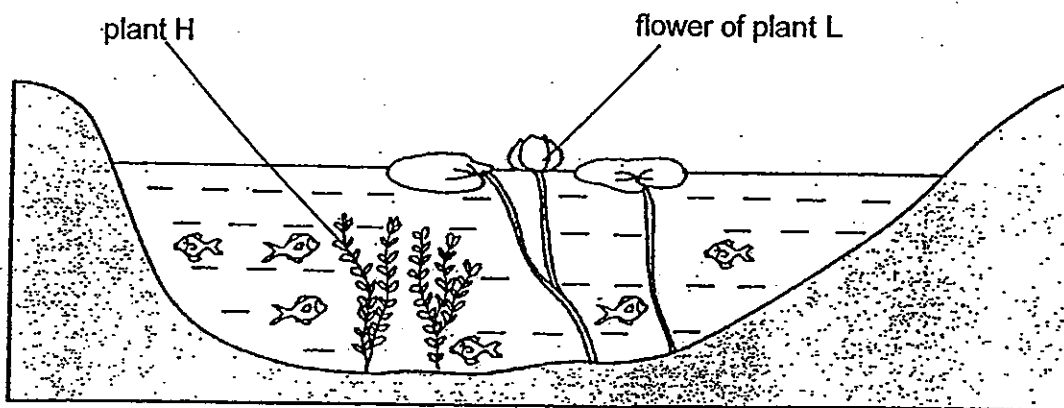

(a) Besides providing oxygen for the fish in the pond, suggest two more reasons why plant H is important for the fish in the pond: [2]

(b) What will happen to the ovule of the flower of plant L after it has been fertilized? [1]

The seeds of plant L has waterproof outer layer.

(c) Explain how plant L disperses its seeds using the characteristic of the seed. [1]

(Go on to the next page)

Score	4
-------	---

42 The diagram below shows part of a rainforest.

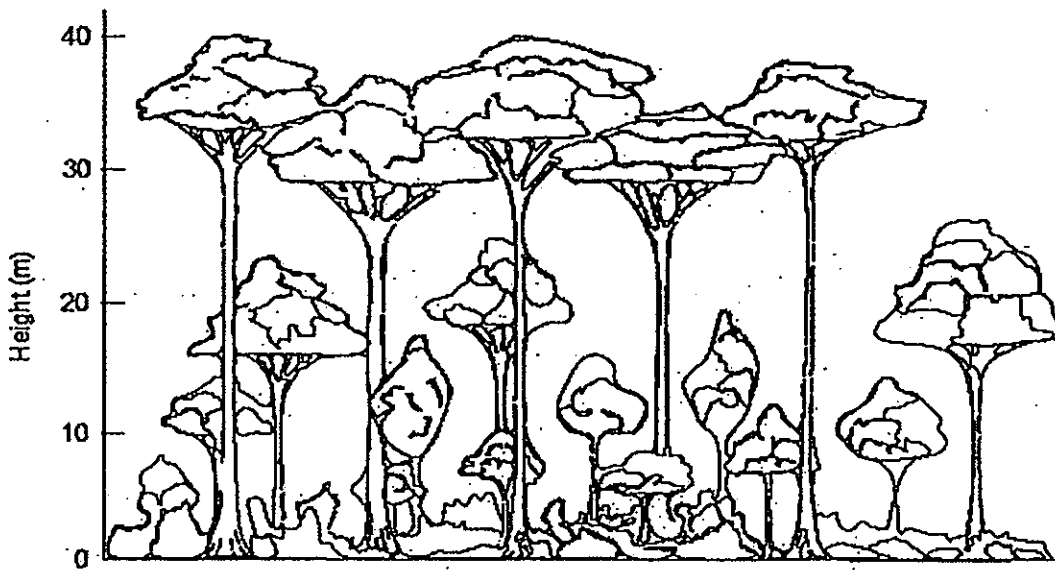

George wanted to investigate the amount of light at different heights in the rainforest. The table below is the result he collected.

Height (m)	Light intensity (units)
0	50
10	150
20	250
30	350
40	450

Plot a line graph using pencil and ruler to represent the data collected by George.

[2]

Light intensity (units)

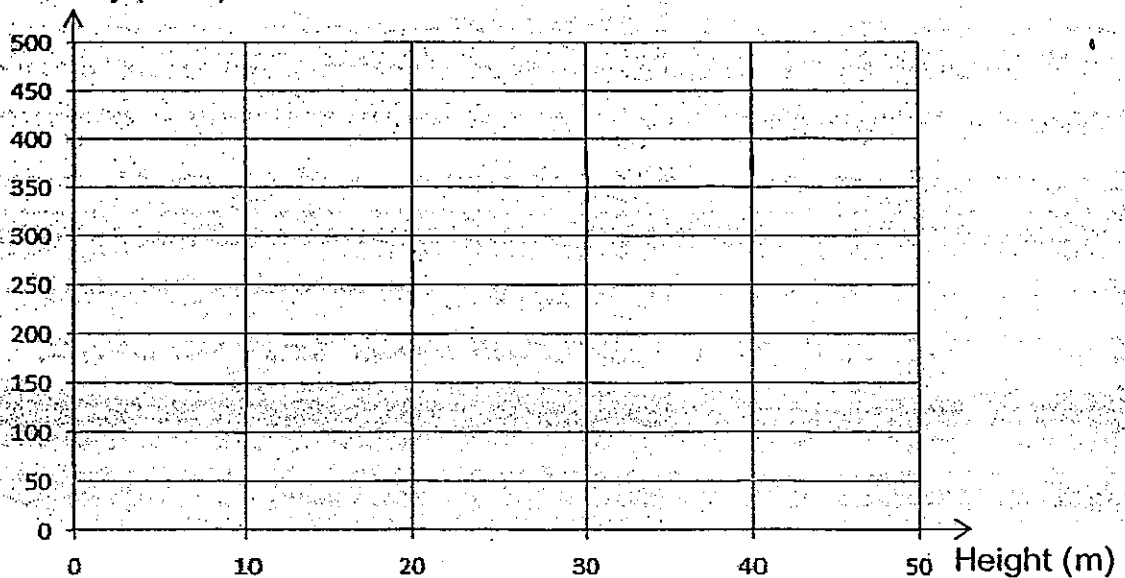

(Go on to the next page)

Score	2
-------	---

- 43 The diagram below shows insect X feeding on the nectar from plant Y's flower. The hairy body of insect X will brush against the anther and stigma of the flower while doing so.

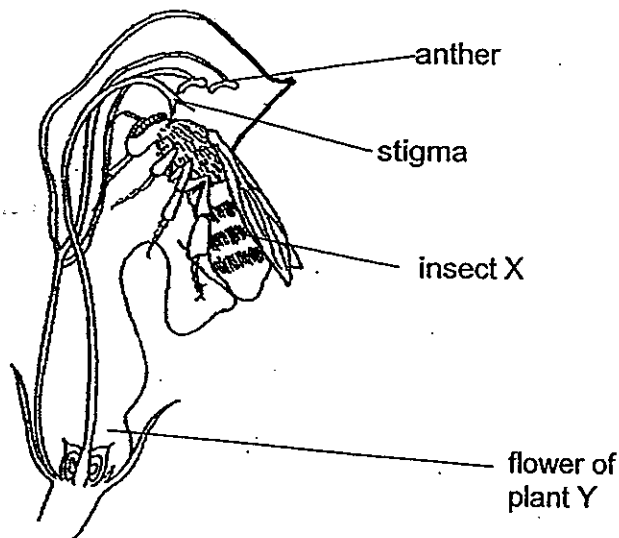

- (a) What process will most likely happen to the flower of plant Y when Insect X flew to another flower of the same specie to obtain nectar from it? [1]

Insect X is the only insect that visits the flower of plant Y for nectar.

- (b) State one advantage and one disadvantage for Plant Y for this close relationship with Insect X. [2]

One advantage for Plant Y:

One disadvantage for Plant Y:

(Go on to the next page)

Score	3
-------	---

- 44 Gary found fruit X with two wing-like structures in the garden as shown in the diagram below. He decided to investigate if the wing-like structures help to disperse the seed.

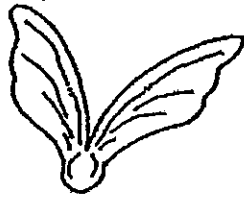

fruit X with two wing-like structures

He dropped the fruit from a height of 10 m and recorded the time taken for the fruit to reach the ground. He repeated the experiment using the same fruit but with its wing-like structure cut-off, one at a time, as shown below.



fruit X with one wing-like structure



fruit X with no wing-like structure

- (a) State one other variable that he must keep the same to ensure that the experiment is a fair one. [1]

For each of the experiment carried out he compared the results as shown in the table below.

Time taken for the fruit to reach the ground (seconds)		
Fruit X with two wing-like structure	Fruit X with one wing-like structure	Fruit X with no wing-like structure
21.6	15.1	7.9

- (b) What conclusion can be drawn from the results above? [1]

- (c) Explain why a seed must be dispersed from the parent plant. [1]

End of Booklet B

Check your answers carefully.

Score	3
-------	---

ANSWER SHEET

EXAM PAPER 2013

SCHOOL : ACS

SUBJECT : PRIMARY 5 SCIENCE

TERM : SA2

Q1	Q2	Q3	Q4	Q5	Q6	Q7	Q8	Q9	Q10	Q11	Q12	Q13	Q14	Q15	Q16	Q17
1	2	1	4	3	4	1	2	3	3	3	3	2	2	3	3	3

Q18	Q19	Q20	Q21	Q22	Q23	Q24	Q25	Q26	Q27	Q28	Q29	Q30
3	2	3	2	4	2	4	3	2	4	3	3	3

31)a)Heat glass B and place ice in glass A.

b)The heat will cause glass B to expand while the ice will cause glass A to contract, making it easier to separate them.

c)No. The water in glass B will cool down faster than the water in glass A as there is a lesser volume of water in glass B.

32)a)The amount of batteries.

b)The bulb lit up brighter than when it was in vinegar than to seawater.

33)a)B is the insulator.

b)1)B1, B2

2)B1, B3

34)a)The cells divide.

b)The chloroplast.

c)The root cell is found underground and does not make food for the plant and so it does not have chloroplast.

35)a)T b)Not c)F d)T

36)a)Graph A it has more oxygen than graph B.
b)Inhaled air has more oxygen than exhaled air.
c)The ribcage protects the lungs.

37)a)Either iron, cobalt, nickel or steel.
b)Rod A and the magnet lost some of its magnetism due to heating.

38)a)R S
b)It digest the food once more and absorb nutrients into the bloodstream.

39)a)The larger the exposed surface area the faster the rate of evaporation.
b)i)Speed of wind. ii)Humidity.

40)a)The water in the beaker evaporated and the water vapour rise and touch the cooler surface of the Petri-dish condense to form water droplets.
b)The base of the Petri-dish in set-up B is not cooler than the water vapour.

41)a)1)The fishes could camouflage with plant X to hide from predators.
2)Plant H provides food for the organisms in the pond.
b)The ovule will turn into a seed.
c)The seed is dispersed by water as the waterproof outer layer of the allows it to prevent water from trap air float on water.

42) Light intensity (units)

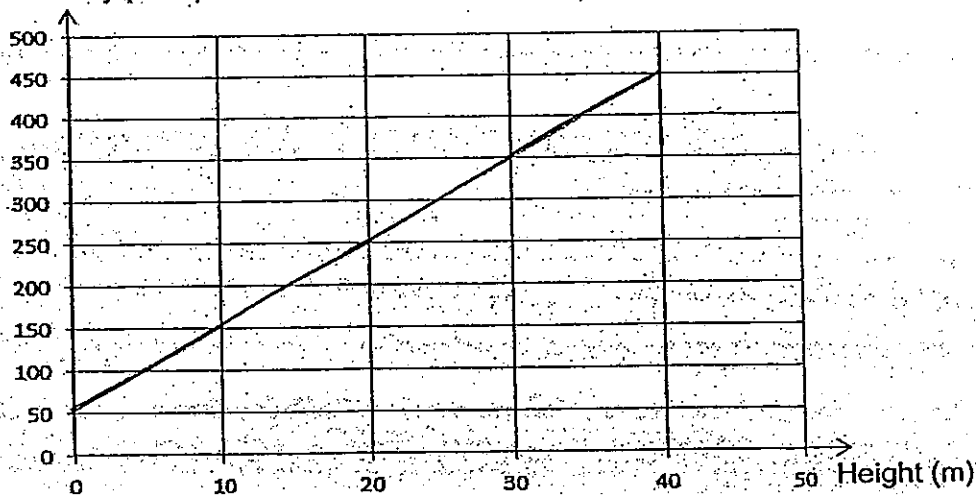

43)a)Pollination.

b)One advantage for Plant Y:

Plant Y's pollen will not land on flower of other species.

One disadvantage for Plant Y:

Plant Y will be extinct if insect X is extinct.

44)a)The amount of wind.

b)The more wing-like structures longer time to reach the ground.

c)To prevent overcrowding so the young does not compete with parent plant for resources.

