



HWA CHONG INSTITUTION
C2 Preliminary Examinations
Higher 2

CANDIDATE NAME

CT GROUP

CENTRE NUMBER

INDEX NUMBER

CHEMISTRY

9729/01

Paper 1 Multiple Choice

20 September 2017

1 hour

Additional Materials: Multiple Choice Answer Sheet
 Data Booklet

READ THESE INSTRUCTIONS FIRST

Write in soft pencil.

Do not use staples, paper clips, glue or correction fluid.

Complete the information on the Answer Sheet as shown below.

1. Enter your **NAME** (as in NRIC). _____

2. Enter the **PAPER NUMBER**. _____

3. Enter your **CT GROUP**. _____

4. Enter your **NRIC NUMBER** or **FIN Number**

5. Now **SHADE** the corresponding circles in the grid for **EACH DIGIT** or **LETTER**

USE PENCIL ONLY							
FOR ALL ENTRIES ON THIS SHEET							
0	1	2	3	4	5	6	7
<input type="radio"/>	<input type="radio"/>	<input type="radio"/>	<input type="radio"/>	<input type="radio"/>	<input type="radio"/>	<input type="radio"/>	<input type="radio"/>

NRIC / FIN										
(S)	(0)	(0)	(0)	(0)	(0)	(0)	(0)	(A)	(K)	(U)
(F)	(1)	(1)	(1)	(1)	(1)	(1)	(1)	(B)	(L)	(V)
(G)	(2)	(2)	(2)	(2)	(2)	(2)	(2)	(C)	(M)	(W)
(T)	(3)	(3)	(3)	(3)	(3)	(3)	(3)	(D)	(N)	(X)

There are **30** questions on this paper. Answer **all** questions. For each question, there are four possible answers **A, B, C** and **D**.

Choose the **one** you consider correct and record your choice in **soft pencil** on the Answer Sheet.

Read the instructions on the Answer Sheet very carefully.

Each correct answer will score one mark. A mark will not be deducted for a wrong answer.

Any rough working should be done in this booklet.

The use of an approved scientific calculator is expected, where appropriate.

1 Why is the second ionisation energy of sodium higher than that of magnesium?

- A Magnesium has more protons than sodium.
- B Sodium has a complete octet, but magnesium does not.
- C The ionic radius of Na^+ ion is larger than that of Mg^+ ion.
- D The electron to be removed from sodium is closer to the nucleus.

2 *Use of the Data Booklet is relevant to this question.*

A mass of 0.457 g of solid carbon dioxide was vapourised into an evacuated gas syringe at r.t.p. A small amount of inert gas was introduced into the gas syringe and the volume of the gas syringe was 334.5 cm^3 . The temperature was kept constant throughout.

How much inert gas was introduced into the gas syringe?

- A $1.4 \times 10^{-2} \text{ mol}$
- B $3.3 \times 10^{-3} \text{ mol}$
- C $3.5 \times 10^{-3} \text{ mol}$
- D $4.3 \times 10^{-3} \text{ mol}$

3 Propadiene and propyne both have the same molecular formula, C_3H_4 . They exist in equilibrium as shown:

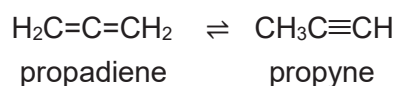

Which bond is present in propadiene but **not** present in propyne?

- A a σ bond formed by $1s - 2sp$ overlap
- B a π bond formed by $2p - 2p$ overlap
- C a σ bond formed by $2sp - 2sp^2$ overlap
- D a σ bond formed by $2sp^2 - 2sp^2$ overlap

4 Which molecules contain a 90° bond angle?

1 SF_6 2 PCl_5 3 XeF_4 4 SiCl_4

- A** 1, 2, 3 and 4
B 1, 2 and 3 only
C 1 and 2 only
D 3 and 4 only

5 When $\text{Tl}^+(\text{aq})$ ions are reacted with $\text{VO}_3^-(\text{aq})$ ions, $\text{Tl}^{3+}(\text{aq})$ ions and $\text{V}^{2+}(\text{aq})$ ions are formed.

Assuming the reaction goes to completion, how many moles of $\text{Tl}^+(\text{aq})$ and $\text{VO}_3^-(\text{aq})$ would result in a mixture containing equal number of moles of $\text{VO}_3^-(\text{aq})$ and $\text{V}^{2+}(\text{aq})$ once the reaction had taken place?

	moles of $\text{Tl}^+(\text{aq})$	moles of $\text{VO}_3^-(\text{aq})$
A	1	2
B	1	3
C	3	2
D	3	4

6 Compound G is produced by actinobacteria in the soil and is responsible for the "it just rained" smell.

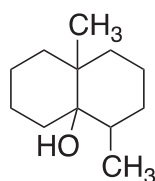

compound G

How many moles of oxygen gas are needed to completely burn 1 mole of compound G?

- A** 16.75 **B** 17.00 **C** 17.25 **D** 17.50

7 Which of the following changes will result in an increase in entropy?

- A** forward reaction of $[\text{Fe}(\text{H}_2\text{O})_6]^{2+}(\text{aq}) + \text{edta}^{4-}(\text{aq}) \rightleftharpoons [\text{Fe}(\text{edta})]^{2-}(\text{aq}) + 6\text{H}_2\text{O}(\text{l})$
- B** mixing of 1 mol of N_2 with 1 mol of Ar at constant volume and temperature
- C** cooling of liquid ethanol from 50 °C to 20 °C
- D** condensation of water vapour

8 Which equation correctly represents both the enthalpy change of combustion, ΔH_c , and the enthalpy change of formation, ΔH_f , of the respective species?

	ΔH_c	ΔH_f	equation
1	Na(s)	$\text{Na}_2\text{O}(\text{s})$	$2\text{Na}(\text{s}) + \frac{1}{2}\text{O}_2(\text{g}) \rightarrow \text{Na}_2\text{O}(\text{s})$
2	C(s)	$\text{CO}_2(\text{g})$	$\text{C}(\text{s}) + \text{O}_2(\text{g}) \rightarrow \text{CO}_2(\text{g})$
3	$\text{H}_2(\text{g})$	$\text{H}_2\text{O}(\text{l})$	$\text{H}_2(\text{g}) + \frac{1}{2}\text{O}_2(\text{g}) \rightarrow \text{H}_2\text{O}(\text{l})$

- A** 1 and 2 only
- B** 2 and 3 only
- C** 2 only
- D** 1, 2 and 3

9 The mechanism below has been proposed for the reaction between CHCl_3 and Cl_2 .

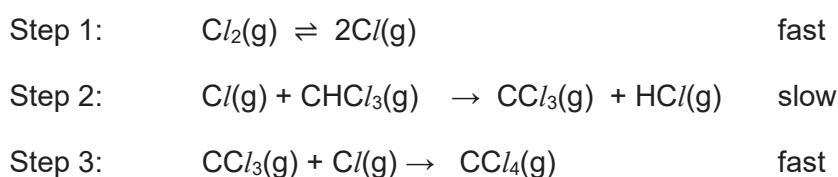

Which rate equation is consistent with this mechanism?

- A** rate = $k[\text{CHCl}_3]^1 [\text{Cl}]^1$
- B** rate = $k[\text{CHCl}_3]^1 [\text{Cl}_2]^1$
- C** rate = $k[\text{CHCl}_3]^1 [\text{Cl}_2]^{1/2}$
- D** rate = $k[\text{Cl}_2]^1$

- 10 Iodine-131 is a radioactive isotope with a half-life of 8 days. Given that radioactive decay is a first-order reaction, what fraction of the isotope would remain after 80 days?

A $\frac{1}{20}$ B $\frac{1}{160}$ C $\frac{1}{2^8}$ D $\frac{1}{2^{10}}$

- 11 The enthalpy change of reaction for the conversion of sulfur dioxide to sulfur trioxide is shown below.

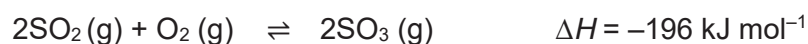

Which of the following statements is correct?

- A When the volume of the system increases at constant temperature, the yield of SO_3 increases.
- B When a catalyst is introduced to the system, the yield of SO_3 increases.
- C The forward reaction is spontaneous at all temperatures.
- D When the temperature is increased, K_c decreases.
- 12 Which of the following silver compounds would give the highest concentration of silver ions in its saturated solution?

	compound	magnitude of solubility product
A	AgCN	6×10^{-17}
B	AgSCN	1×10^{-12}
C	Ag_2SO_3	2×10^{-14}
D	Ag_3PO_4	9×10^{-17}

- 13 Which of the following is a satisfactory indicator for the titration of 0.1 mol dm^{-3} methylamine and 0.1 mol dm^{-3} hydrochloric acid?

- A methyl red (pH range 4.2 – 6.3)
- B bromothymol blue (pH range 6.0 – 7.6)
- C phenolphthalein (pH range 8.2 – 10.0)
- D There is no satisfactory indicator.

- 14 Triglycerides are the main constituents of body fat in humans and animals. The diagram shows the structure of a triglyceride.

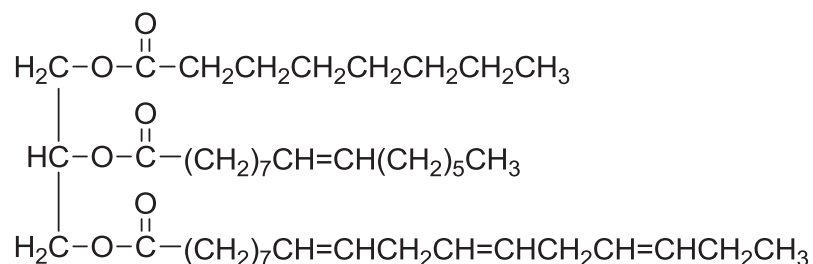

What is the total number of stereoisomers possible for this triglyceride?

- A 2^1 B 2^3 C 2^4 D 2^5
- 15 When heated with chlorine, the following hydrocarbon undergoes free radical substitution. In the propagation step, the free radical $\text{Q}\cdot$ is formed by the loss of one hydrogen atom.

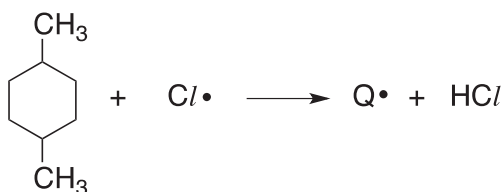

Ignoring any stereoisomers, how many different forms of $\text{Q}\cdot$ are theoretically possible?

- A 3 B 4 C 6 D 8
- 16 Compound W is heated with excess acidified KMnO_4 for a prolonged period.

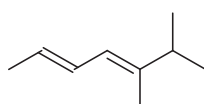

compound W

Which of the following compounds is **least likely** to be a product of this reaction?

- A CO_2 C
- B
- D

- 17 Liquid bromine is added separately to the following pairs of compounds under various conditions.

Which of the following pairs of compounds will give the same observations?

- A** Benzene and phenol, in the presence of uv light.
B Hexane and methylbenzene, in the presence of uv light.
C Pentene and pentane, in the absence of uv light.
D Phenylamine and benzene, in the absence of uv light.

- 18 Enantiomeric excess is the measure of the excess of one enantiomer over another in a mixture.

Consider a pair of enantiomers, R and S. If the R enantiomer makes up 75% of the mixture while the S enantiomer makes up 25% of the mixture, R has an enantiomeric excess of 50%.

Which of the following reactions would result in a mixture which gives an enantiomeric excess of 0%?

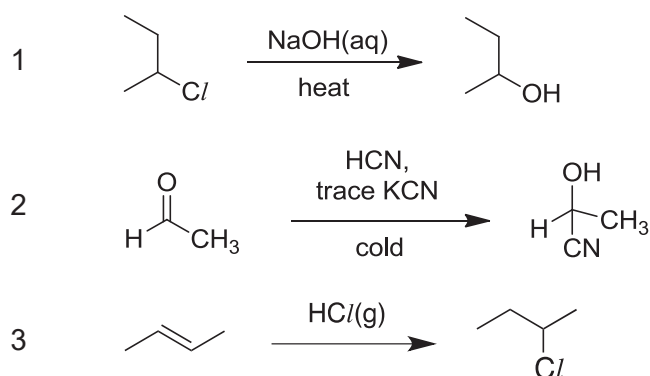

- A** 1 and 2 only
B 1 and 3 only
C 2 and 3 only
D 1, 2 and 3

- 19 What will be produced when the following compound is reacted with cold NaOH(aq)?

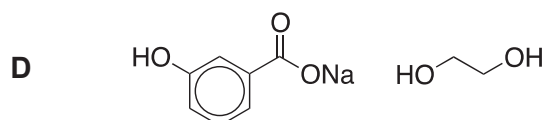
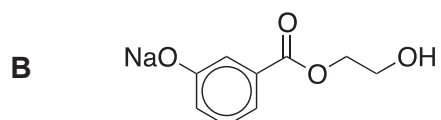
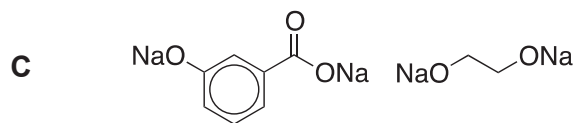
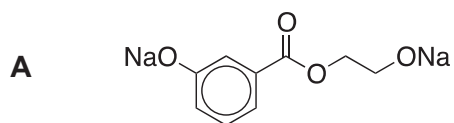
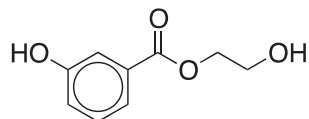

- 20 Diadzein belongs to a class of compounds known as isoflavenoids, and is a major component of soya beans.

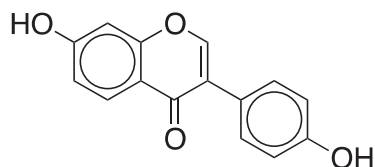

diadzein

Which statement about diadzein is **not** correct?

- A** When diadzein reacts with aqueous Br_2 , the product contains chiral centres.
- B** When heated with ethanoic acid and concentrated sulfuric acid, diadzein forms an ester.
- C** When neutral FeCl_3 is added to diadzein, a purple colouration is observed.
- D** When 2,4-DNPH is added to diadzein, an orange precipitate is observed.

21 Which reaction yields a carbon compound incorporating deuterium, D? [D = ^2H]

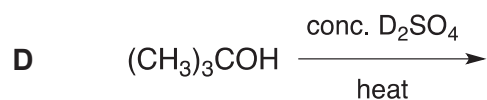
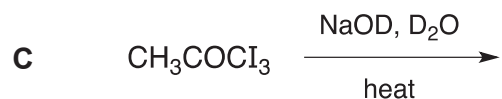
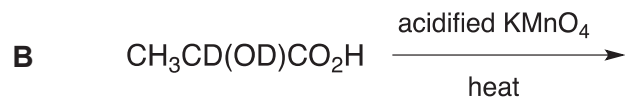
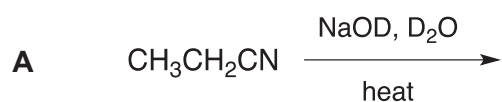

22 Which of the following statements about the reaction with Fehling's reagent is correct?

- 1 In a positive test, Cu^{2+} is reduced to produce an oxide.
- 2 Propanone will react to form a propanoate ion.
- 3 Benzaldehyde will give a brick-red precipitate.

- A 1 only
 B 1 and 2 only
 C 1 and 3 only
 D 2 and 3 only

23 Which of the following shows an increasing trend in $\text{p}K_{\text{a}}$?

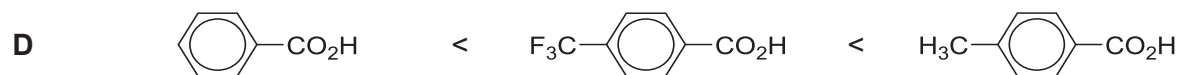
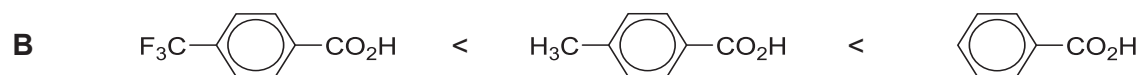

- 24 Which are the products formed when compound Z reacts with the following reducing agents?

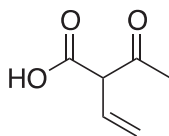

compound Z

	H_2, Pt	$LiAlH_4$ in dry ether
A		
B		
C		
D		

- 25 Which of the following transformations is **not** correct?

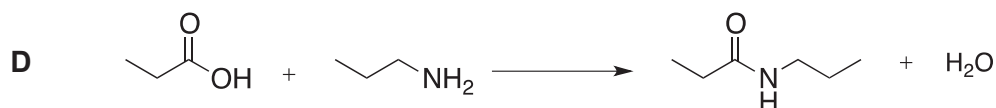
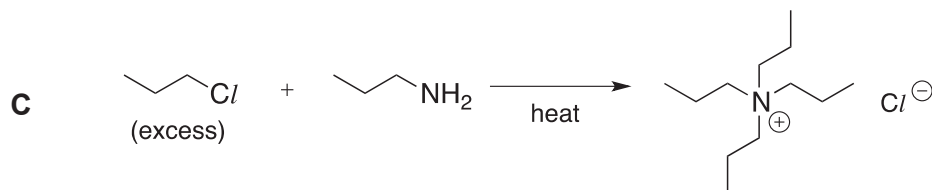
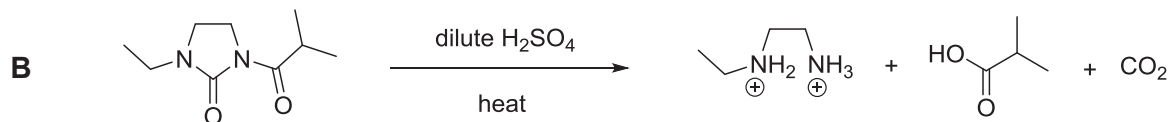
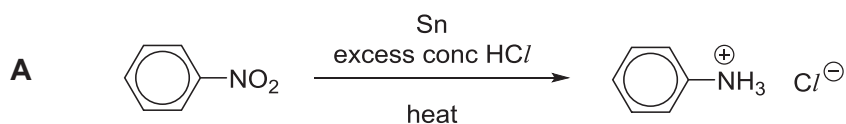

26 *Use of the Data Booklet is relevant to this question.*

By considering the relevant E^\ominus values, which halogen will oxidise $\text{Fe}^{2+}(\text{aq})$ to $\text{Fe}^{3+}(\text{aq})$?

- A bromine and chlorine only
- B bromine and iodine only
- C chlorine only
- D iodine only

27 Which of the following about the anodising of aluminium using dilute sulfuric acid is correct?

- 1 The thickness of the solid Al_2O_3 layer on the surface of the aluminium object is increased.
- 2 Oxygen is produced at the cathode.
- 3 The Al object to be anodised is the positive electrode.

- A 1 only
- B 1 and 3 only
- C 2 and 3 only
- D 1, 2 and 3

28 Y is an element in Period 3. When water is added to a chloride of Y, an acidic solution will be obtained. When water is added to an oxide of Y, a basic solution will be obtained.

Which of the following could Y be?

- A Na B Mg C Al D Si

- 29 Which of the following correctly describes the complex formed when different reagents are added to solid copper(II) sulfate?

	reagent added	colour of resultant solution	shape of complex ion formed
1	H ₂ O	pale blue	octahedral
2	conc. HCl	yellow	tetrahedral
3	excess NH ₃ (aq)	dark blue	tetrahedral

- A 1 and 2 only
 B 1 and 3 only
 C 2 and 3 only
 D 1, 2 and 3

- 30 *Use of the Data Booklet is relevant to this question.*

Consider the following reaction scheme starting from solution J, which contains one metal cation.

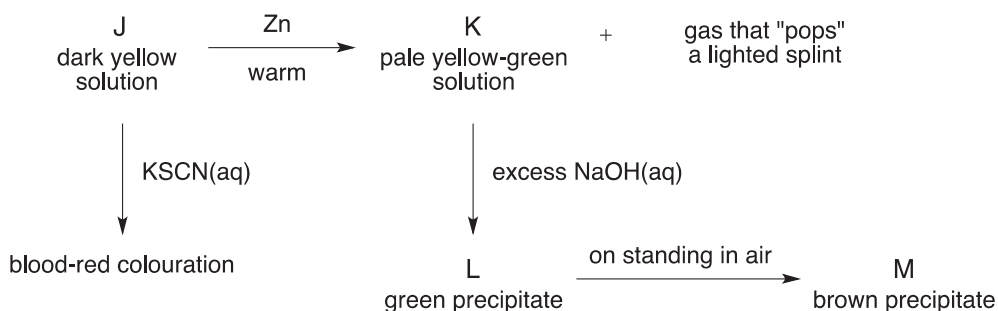

Which of the following statements is correct?

- A The metal cation present in solution J is Fe²⁺.
 B The gas produced is able to reduce Fe²⁺ to Fe.
 C The reaction from K to L is a ligand exchange reaction.
 D The metal cation present in solution J and in precipitate M is the same.



HWA CHONG INSTITUTION
C2 Preliminary Examinations
Higher 2

CANDIDATE NAME

CT GROUP

CENTRE NUMBER

INDEX NUMBER

CHEMISTRY

9729/02

Paper 2 Structured Questions

11 September 2017

2 hours

Candidates answer on the Question Paper

Additional Materials: Data Booklet

READ THESE INSTRUCTIONS FIRST

Write your **name**, **CT group**, **centre number** and **index number** clearly in the spaces above.

Write in dark blue or black pen.

You may use a HB pencil for any diagrams or graphs.

Do not use staples, paper clips, glue or correction fluid.

Answer all questions in the spaces provided in the Question Paper.

The use of an approved scientific calculator is expected, where appropriate.

A Data Booklet is provided.

At the end of the examination, fasten all your work securely together.

The number of marks is given in brackets [] at the end of each question or part question.

For Examiner's Use	
1	/ 12
2	/ 14
3	/ 16
4	/ 12
5	/ 13
6	/ 8
Deductions	
Total	/ 75

Calculator Model:

- 1 (a) Atmospheric hydrogen and iodine, each 0.10 mol, are placed in a 2 dm³ evacuated flask at 400 °C. After 30 minutes, the following equilibrium was established and the amount of HI was found to be 0.12 mol.



- (i) Write the expression for K_c and calculate its value at 400 °C.

[2]

- (ii) At 40 minutes, the temperature of the system was raised to 600 °C and equilibrium was re-established at 60 minutes.

Given that the K_c at 600 °C was 0.36, show that the equilibrium concentrations of H₂, I₂ and HI in the equilibrium mixture at 60 min are 0.0385 mol dm⁻³, 0.0385 mol dm⁻³ and 0.0231 mol dm⁻³ respectively.

[2]

- (iii) On the grid below, sketch the concentration versus time graphs for I_2 and HI respectively under the conditions as described in (a)(i) and (a)(ii) from 0 to 70 minutes. Label the graphs and indicate significant values on the axes.

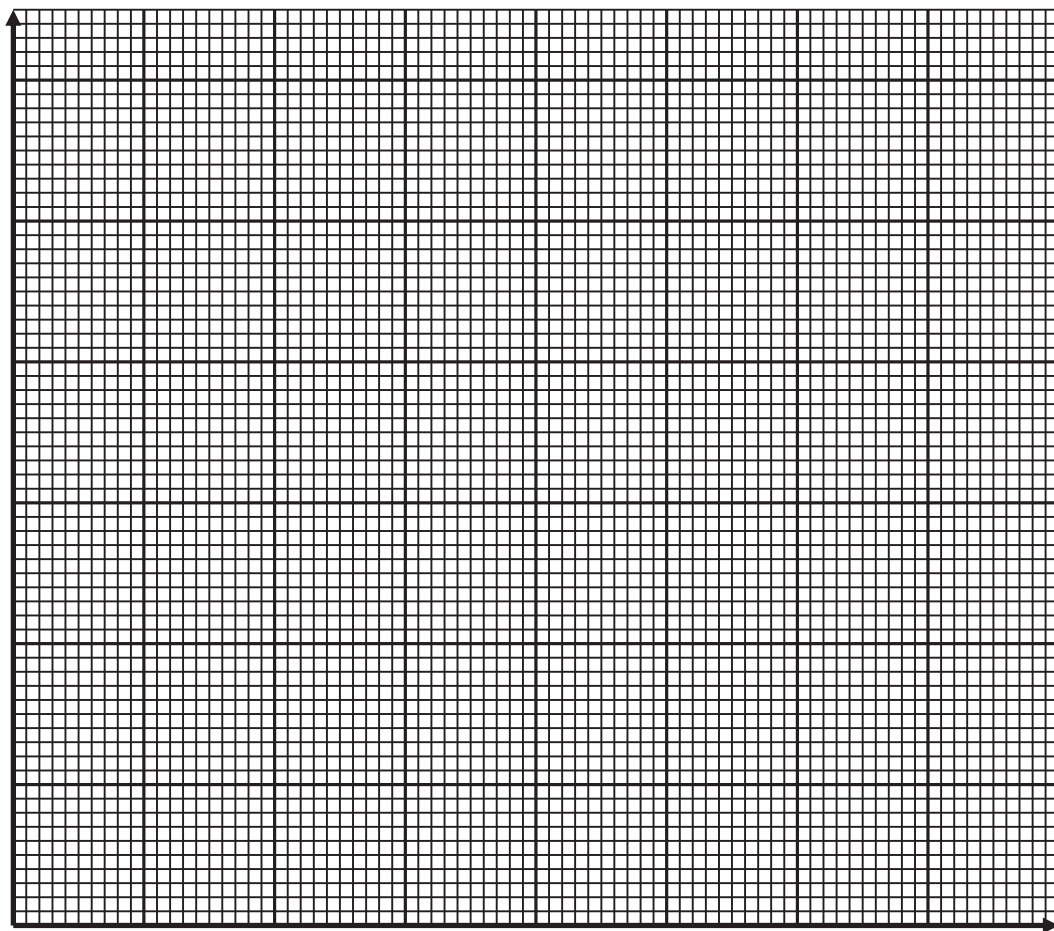

[4]

- (iv) To find the amount of HI present at equilibrium at 30 minutes, the flask can be rapidly cooled and the HI is dissolved in water. The solution obtained can be titrated against $NaOH(aq)$. Explain why the flask has to be rapidly cooled.

.....
.....

[1]

- (b) When I_2 combines with I^- , it forms the I_3^- ion which is responsible for the characteristic brown colour of aqueous I_2 .

Draw a dot-and-cross diagram to show the bonding in I_3^- .

[1]

- (c) Explain, in terms of structure and bonding, why I_2 has a higher boiling point than HI.

.....

.....

.....

.....

.....

[2]

[Total: 12]

2 (a) Metal ions, especially transition metal ions, possess the ability to form complexes with both organic and inorganic *ligands*.

1,10-phenanthroline (also known as 'phen') and ferrozine are organic ligands that can form complexes with Fe²⁺ ions.

(i) Explain the term '*ligand*'.

.....

[1]

(ii) In the following experiment, varying volumes of solutions of 0.1 mol dm⁻³ Fe²⁺ and 0.1 mol dm⁻³ phen are mixed to produce a complex of orange-red colour.

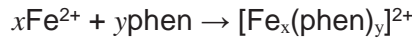

The concentration of the orange-red complex formed is proportional to the absorbance of the solution which is measured using a colorimeter. The following graph is plotted using the results of the experiment.

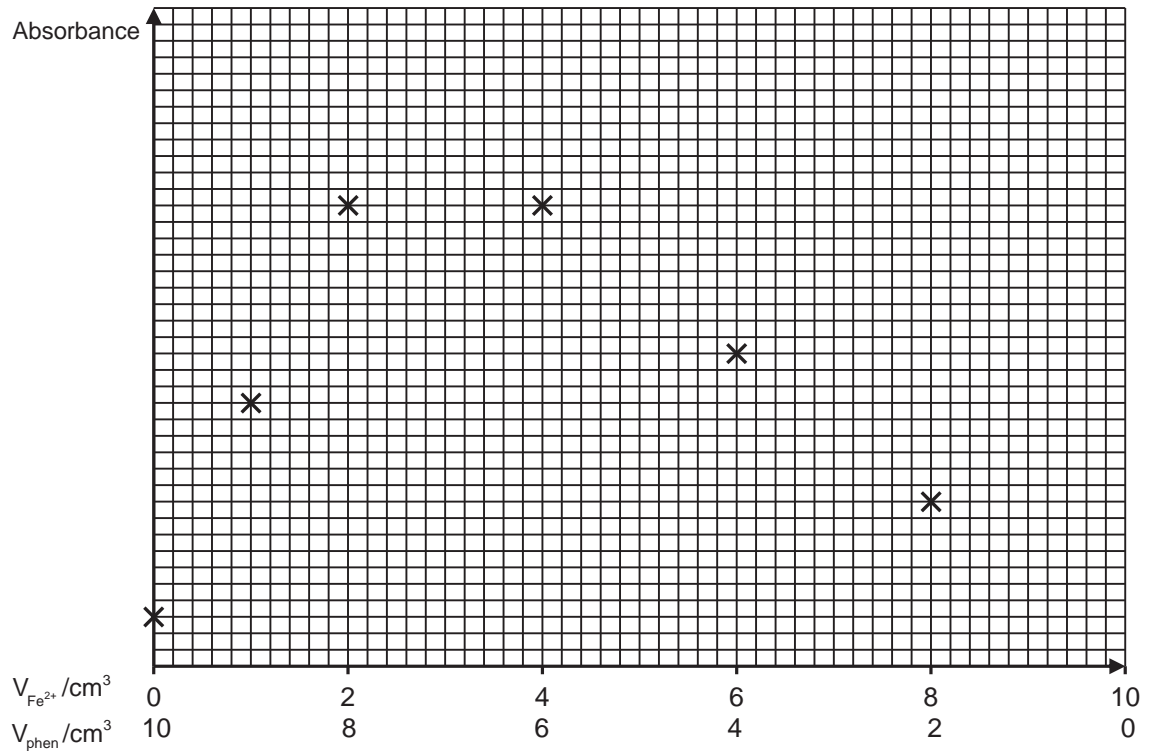

By drawing suitable lines on the graph, deduce the formula of the complex formed between Fe²⁺ and phen.

Formula of the complex

[2]

- (iii) Explain why the solution of the complex formed between Fe^{2+} and phen exhibits an orange-red colour.

.....
.....
.....
.....

[3]

- (iv) Ferrozine reacts with Fe^{2+} in solutions to give a purple complex. Suggest why the colour of this complex is different from that formed with phen, by considering your answer to (iii).

.....
.....

[1]

- (b) Alkyl groups can be substituted into a benzene ring in the presence of a suitable catalyst. This is known as a Friedel-Crafts alkylation.

- (i) Suggest a suitable reagent and condition to convert benzene to ethylbenzene.

Reagent: Condition:

[1]

- (ii) Name and outline the mechanism to convert benzene to ethylbenzene using the reagent and condition you proposed in (b)(i). Show all charges and use curly arrows to show the movement of electron pairs.

[3]

- (c) Fermentation produces phenolic compounds that give wheat beer its distinctive spicy, clove-like flavor. This flavor comes from phenolic molecules such as vanillin and 4-VG.

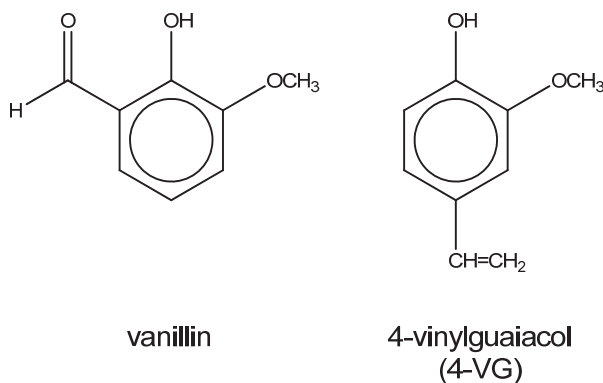

- (i) Schiff bases are an important class of ligands that form complexes which can be used as antimicrobial agents. They are derived when a condensation reaction takes place between an amine and a carbonyl group. Vanillin can be used to synthesise the Schiff base ligand below.

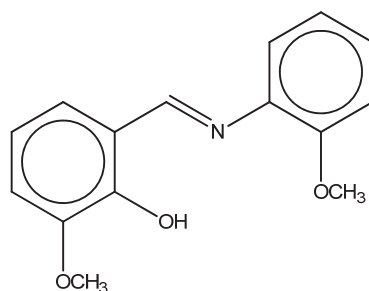

Give the structure of the molecule that reacted with vanillin to form this Schiff base ligand.

[1]

- (ii) Suggest a simple chemical test to distinguish between vanillin and 4-VG. State the reagent and condition used and the expected observation for **each** compound.

.....

[2]

[Total: 14]

- 3 Epoxides are a class of organic compounds with a three-membered ring structure containing two carbon atoms and one oxygen atom. The three-membered ring in epoxides makes them highly reactive and susceptible to “ring-opening reactions” whereby one of the C–O bonds breaks. Hence, epoxides are important precursors for many industrial and commercial applications.

One such epoxide is styrene oxide.

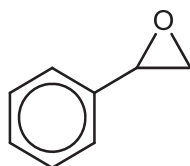

styrene oxide

- (a) (i) State the hybridisation of the carbon atoms in the three-membered ring in styrene oxide, and the typical bond angle around a carbon atom with the same hybridisation.

hybridisation:

typical bond angle:

[2]

- (ii) The actual bond angle in the three-membered ring in styrene oxide is 60° . By comparing this bond angle with your answer in (a)(i), suggest why epoxides are susceptible to “ring-opening reactions”.

.....

[1]

- (b) An example of an epoxide ring-opening reaction is the hydrolysis of styrene oxide in the presence of a strong acid catalyst to form styrene glycol. To determine the reaction mechanism, isotopic labelling was used. The hydrolysis was carried out using “heavy-oxygen water”, H_2^{18}O .

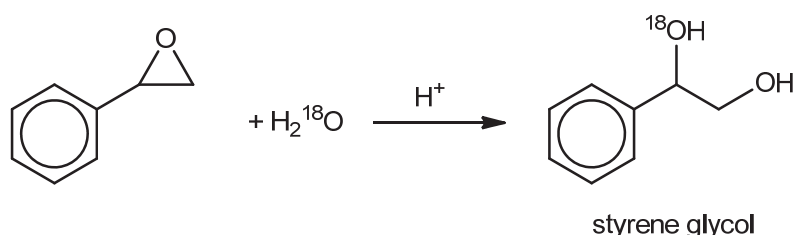

It is found that the reaction follows a unimolecular nucleophilic substitution mechanism. Some details of the mechanism are as given.

1. Protonation of the oxygen atom by a strong acid catalyst
2. Heterolytic fission of the C–O bond to generate a carbocation intermediate
3. Attack of the carbocation by one molecule of H_2^{18}O to form a new C–O bond
4. Loss of a proton to form styrene glycol and regenerate the acid catalyst

- (i) Step 1 of the mechanism has been drawn for you:

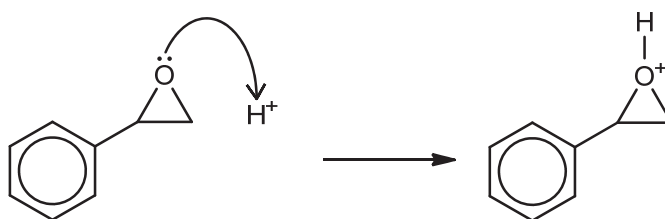

Describe steps 2 to 4 of the mechanism for this unimolecular nucleophilic substitution reaction. Show all relevant lone pairs and charges, and indicate the movement of electron pairs with curly arrows. You do not need to label the ^{18}O atom in any water molecules.

[3]

- (ii) Draw the structure of a side product formed if the acid catalyst used is dilute hydrochloric acid.

[1]

- (iii) Analysis of the styrene glycol product formed from the hydrolysis showed the presence of trace amounts of an isotopic isomer **A** (in which the oxygen-18 atom is bonded to a different carbon atom).

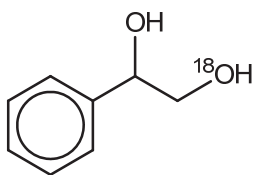
isotopic isomer **A**

Suggest how isotopic isomer **A** could have been formed during the reaction and why it was formed only in trace amounts.

.....

[2]

- (c) Compound **D** can be synthesised from styrene glycol by the following route.

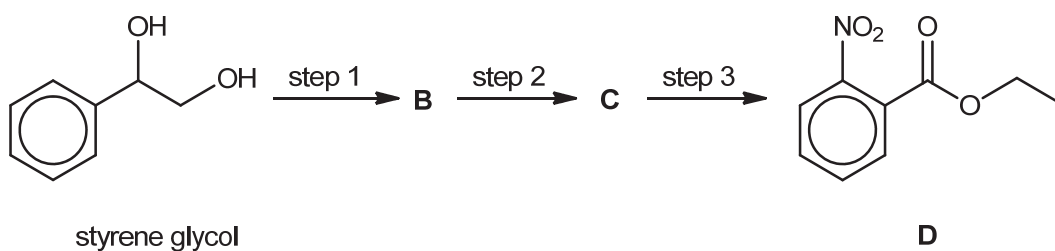

styrene glycol

D

State the reagents and conditions for steps 1 to 3, and draw the structures of the intermediate compounds **B** and **C**.

step 1

step 2

step 3

Compound B	Compound C
-------------------	-------------------

[5]

- (d) Ethylene oxide is another epoxide, and can undergo polymerisation with a small amount of ethylene glycol to form polyethylene glycol (PEG).

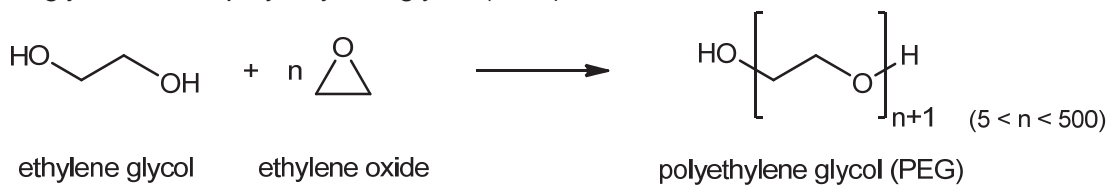

PEG is highly soluble in water, in contrast to long-chain fatty acids such as lauric acid, $\text{CH}_3(\text{CH}_2)_{10}\text{CO}_2\text{H}$, which are only sparingly soluble.

With the aid of a labelled diagram, explain why PEG is highly soluble in water despite its large M_r .

.....

.....

.....

[2]

[Total: 16]

- 4 The olive tree has been used for centuries in the Mediterranean region for culinary and medicinal practices. The leaves and the fruit contain a number of organic compounds which are responsible for these benefits. One of these compounds is elenolic acid. The structure of elenolic acid is shown below.

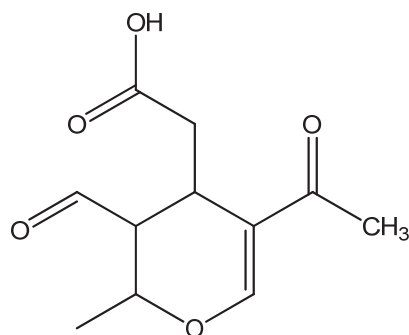

elenolic acid

- (a) Name **four** functional groups, other than the ether functional group ($-\text{C}-\text{O}-\text{C}-$), that are present in the elenolic acid molecule.

.....

.....

[4]

- (b) Draw the structural formula of all the organic products formed when elenolic acid is treated with the following reagents. Assume the ether functional group is inert.

- (i) LiAlH_4 in dry ether

[1]

- (ii) hot aqueous iodine in an excess of sodium hydroxide

[2]

(iii) hot aqueous KMnO_4 in an excess of dilute sulfuric acid

[2]

(c) Explain how the acidity of elenolic acid compares with that of compound **M**.

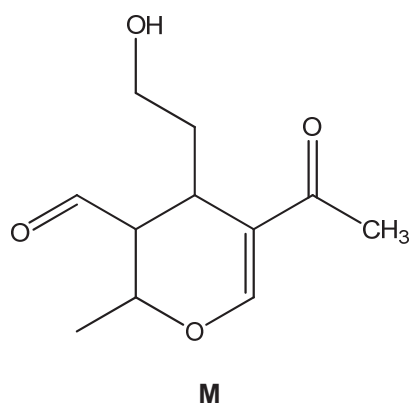

[3]

[Total: 12]

- 5 (a) The Avogadro constant may be determined via an electrolytic method in a school laboratory. In a typical experiment, copper electrodes are connected to a battery and dipped into an electrolyte of dilute sulfuric acid.

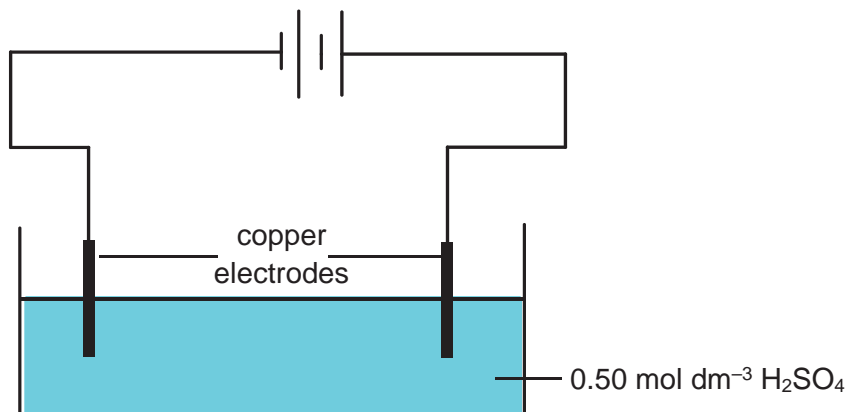

The experimental results are tabulated as follows.

Initial mass of anode/ g	0.968
Final mass of anode/ g	0.254
Time of electrolysis/ s	3100
Average current/ A	0.700

- (i) Write an equation for the reaction that occurs at the anode. Include state symbols in your answer.

..... [1]

- (ii) Using the above experimental results, calculate a value for the Avogadro constant.

[3]

- (b) A 10-cent coin is typically made up of cupronickel, an alloy consisting of both copper and nickel. In another electrolytic experiment, a 10-cent coin is made the anode and dipped in an electrolyte of $6.0 \text{ mol dm}^{-3} \text{ HCl}$. Graphite is used as the cathode.

The 10-cent coin is gradually but completely dissolved, resulting in an intensely green-coloured electrolyte. Copper is deposited at the cathode.

- (i) Explain, by quoting relevant E^\ominus values, why copper instead of nickel is deposited at the cathode.

.....

.....

.....

[2]

- (ii) The complex responsible for the colour of the electrolyte is NiCl_4^{2-} . State the electronic configuration of Ni in NiCl_4^{2-} .

.....

[1]

- (iii) NiCl_4^{2-} is an example of a tetrahedral complex. Similar to an octahedral complex, the d subshell of a transition metal ion in a tetrahedral complex is split into two energy levels. However, the d orbitals found in the upper energy level in the octahedral complex are now found in the lower energy level of the tetrahedral complex and vice versa.

Using the Cartesian axes given below, draw **fully-labelled** diagrams of the following.

- One of the d orbitals at the upper energy level in a tetrahedral complex.
- One of the d orbitals at the lower energy level in a tetrahedral complex.

upper

lower

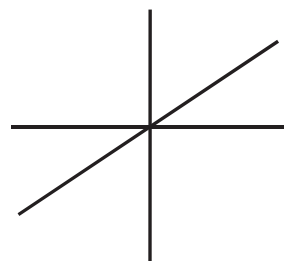
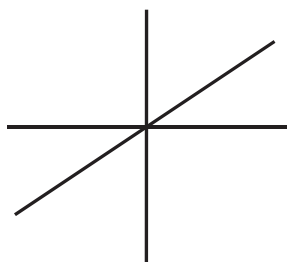

[2]

- (c) An isocyanide is an organic compound with the functional group -NC . When the -NC group is attached to a benzene ring, the compound is called an aromatic isocyanide.

Aromatic isocyanides have been found to react in NaOH (aq) yielding the corresponding formamides.

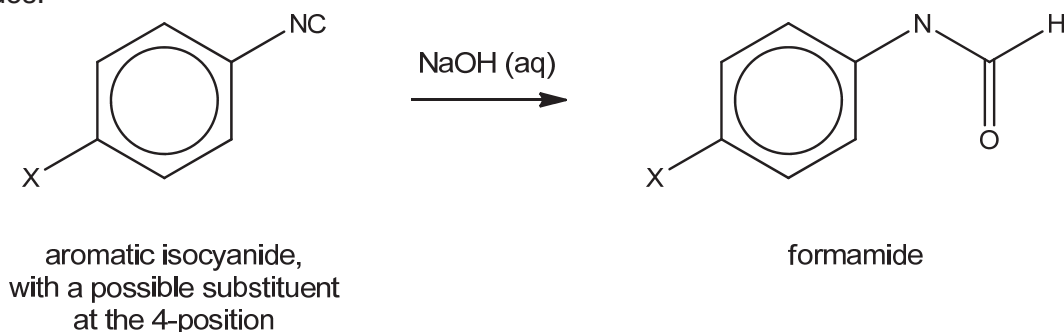

The order of reaction with respect to the aromatic isocyanide was found to be one in an earlier series of experiments.

In further experiments, to determine the order of reaction with respect to OH^- , the concentration of aromatic isocyanide used was kept at $5.0 \times 10^{-4} \text{ mol dm}^{-3}$ while the concentration of OH^- used was varied between 0.10 and 0.80 mol dm^{-3} . To determine the effect of different substituents X , the reaction was carried out using different aromatic isocyanides. The graph of the observed rate constant, k_{obs} against $[\text{OH}^-]$ is plotted as follows.

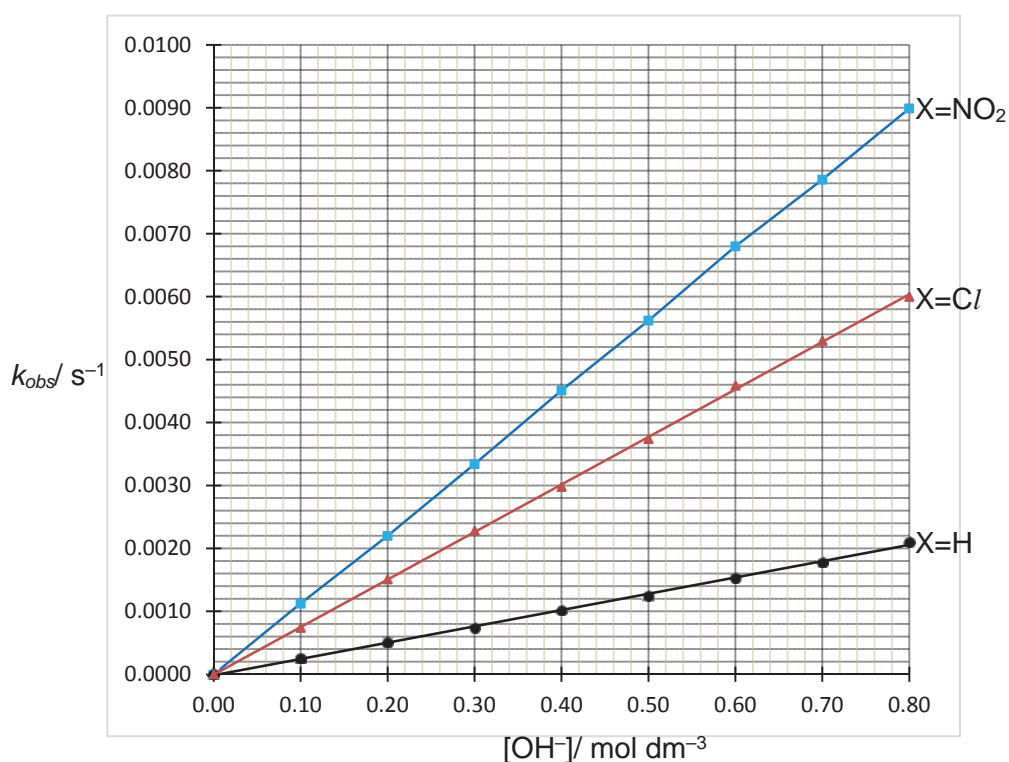

- (i) Given that $k_{\text{obs}} = k[\text{OH}^-]^m$, deduce the order of reaction with respect to OH^- .

[1]

- (ii) Hence or otherwise, write a rate equation for the reaction between aromatic isocyanides and OH^- and use it to determine the rate of the reaction for $X = \text{Cl}$ when $[\text{OH}^-] = 0.74 \text{ mol dm}^{-3}$.

[2]

- (iii) In the reaction, OH^- acts as a nucleophile to attack the carbon atom of the isocyanide group. Explain why the gradients of the graph for $X = \text{NO}_2$ and $X = \text{Cl}$ were steeper than that for $X = \text{H}$.

.....
.....

[1]

[Total: 13]

- 6 A common magic demonstration where containers of “water” are mixed to obtain “milk” makes use of the following reaction between methanal and sulfite:



As the reaction produces hydroxide ions, the pH of the solution rises. If a buffer solution is present, this rise is gradual at first. Eventually, when the buffer is exhausted, the pH rises quickly. If the cation Mg^{2+} is also present, the solution soon becomes saturated in magnesium hydroxide and a white precipitate appears.

The procedure of the demonstration is given below.

Procedure (steps 1 to 3 are prepared ahead of the demonstration whereas step 4 is performed in front of the audience)

To the same beaker, the following solutions are added:

1. Add 100 cm³ of 0.100 mol dm⁻³ Na₂SO₃ (solution A).
2. Add 100 cm³ of 0.400 mol dm⁻³ NaHSO₃ (solution B).
3. Add 5 cm³ of 2.00 mol dm⁻³ MgCl₂ (solution C).
4. Add 200 cm³ of 0.300 mol dm⁻³ HCHO (solution D) and swirl.

20 s after step 4 is carried out, a white cloudy solution (“milk”) suddenly appears in the beaker owing to the precipitation of magnesium hydroxide.

The following information are relevant.

K_a of HSO_3^-	$1.02 \times 10^{-7} \text{ mol dm}^{-3}$
K_{sp} of $\text{Mg}(\text{OH})_2$	$5.66 \times 10^{-12} \text{ mol}^3 \text{ dm}^{-9}$

- (a) What do you understand by the term *buffer solution*?

.....

 [1]

- (b) Calculate the pH of the buffer solution in the beaker after Step 2.

[1]

- (c) Write **one** equation to show how this buffer performs its function in (a), in the process delaying the appearance of the white precipitate.

.....
 [1]

(d) Show that the white precipitate first appears when the pH in the beaker is 9.18.

[2]

(e) State a solution (A, B, C or D) whose concentration you would **decrease** in order for the white precipitate to appear earlier.

[1]

(f) The procedure can be slightly amended as follows to produce “tea” instead of “milk”.

- Steps 1, 2 and 4 are unchanged.
- In step 3, instead of solution C, add 5 cm³ of 3-nitrophenol indicator.

Indicator	colour in acidic solution	colour in alkaline solution	working pH range
3-nitrophenol	colourless	yellow	6.7 – 8.7

In this way, a yellow solution suddenly appears at the end of the demonstration.

Previously, “milk” appeared 20 s after step 4 was carried out. Explain whether “tea” appears earlier, later or also at 20 s after step 4 was carried out.

[1]

(g) Suggest another indicator you could use in place of 3-nitrophenol so that “red wine” may be obtained instead of “tea”.

[1]

[Total: 8]



HWA CHONG INSTITUTION
C2 Preliminary Examinations
Higher 2

CANDIDATE
NAME

CT GROUP

16S

CENTRE
NUMBER

--	--	--	--

INDEX
NUMBER

--	--	--	--

CHEMISTRY

9729/03

Paper 3 Free Response

18 September 2017

2 hours

Candidates answer on separate paper.

Additional Materials: Answer Paper
 Data Booklet

READ THESE INSTRUCTIONS FIRST

Write your **name**, **CT group**, **centre number** and **index number** clearly in the spaces above.

Write in dark blue or black pen.

You may use a HB pencil for any diagrams or graphs.

Do not use staples, paper clips, glue or correction fluid.

Section A

Answer **all** questions.

Section B

Answer **one** question.

Begin each question on a **new sheet of writing paper**.

A Data Booklet is provided.

The use of an approved scientific calculator is expected, where appropriate.

The number of marks is given in brackets [] at the end of each question or part question.

At the end of the examination, fasten all your work securely together.

Circle the question numbers for the questions that you have attempted on the cover page provided.

Section A

Answer **all** the questions in this section.

- 1 (a) *Azurite* is a deep blue copper-containing mineral. For many centuries, finely ground rock containing azurite has been used as a pigment in blue paints. Azurite is a mixture of copper(II) carbonate and copper(II) hydroxide. The formula of pure azurite is $\text{Cu}_3(\text{CO}_3)_2(\text{OH})_2$, which has a relative formula mass of 344.5.

The percentage by mass of pure azurite in a sample of finely ground rock can be determined by back titration. 3.70 g of the sample is added to 100 cm³ of 0.425 mol dm⁻³ sulfuric acid. The resulting solution was made up to 250 cm³ with distilled water. 25.0 cm³ of the diluted solution required 26.50 cm³ of 0.100 mol dm⁻³ sodium hydroxide for neutralization.

Dilute sulfuric acid reacts with pure azurite as shown in the following equation.



Calculate the percentage by mass of pure azurite in the sample. You may assume that azurite is the only substance in the rock that reacts with sulfuric acid. [3]

- (b) The brick-red precipitate, Cu_2O , dissolves in concentrated ammonia solution to form a colourless complex ion **P**, $[\text{Cu}(\text{NH}_3)_x]^{n+}$, which has a linear geometry about the central metal ion. When left exposed to air, the colourless complex ion **P** turns into a deep blue solution, containing the complex ion $[\text{Cu}(\text{NH}_3)_4]^{2+}$.

(i) State the value of x and write the formula of complex ion **P**. [2]

(ii) With the help of the *Data Booklet*, write the two half equations, and hence the overall equation for the reaction of the colourless complex ion **P** to form $[\text{Cu}(\text{NH}_3)_4]^{2+}$. [2]

- (c) Iodine and chlorine react together to give iodine trichloride.

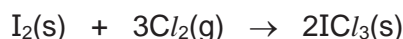

(i) Construct a fully labelled energy cycle relating the reactants and products of this reaction to their gas phase atoms. Use your cycle to calculate the average bond energy of the I–Cl bond in ICl_3 .

Your cycle should include relevant data from the *Data Booklet* together with the following data.

standard enthalpy change of formation (ΔH_f^\ominus) of $\text{ICl}_3(\text{s})$	= –81 kJmol ⁻¹
enthalpy change of sublimation of $\text{I}_2(\text{s}) \rightarrow \text{I}_2(\text{g})$	= +38 kJmol ⁻¹
enthalpy change of sublimation of $\text{ICl}_3(\text{s}) \rightarrow \text{ICl}_3(\text{g})$	= +60 kJmol ⁻¹

[4]

(ii) The standard Gibbs free energy of formation, ΔG_f^\ominus , of $\text{ICl}_3(\text{s})$ is –40.4 kJmol⁻¹. Calculate ΔS_f^\ominus and comment on its sign with respect to the reaction. [2]

- (d) The antipyretic (fever-reducing) drug *antifebrin* can be made via a 3-step synthetic route, starting from benzene.

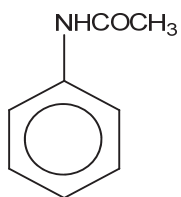

antifebrin

- (i) State the 3 types of reactions involved (in sequence) in the formation of antifebrin from benzene. [3]
- (ii) Draw the structures of the products formed when antifebrin was subjected to prolonged heating with dilute sulfuric acid. [1]

[Total: 17]

2 Thiols are a group of organic compounds which may be represented as $C_nH_{2n+1}SH$ or RSH , where R is an alkyl group.

(a) In an experiment a sample of thiol was completely burnt in a stoichiometric amount of oxygen. The product mixture was collected in a 1.65 dm^3 flask at $110 \text{ }^\circ\text{C}$ and 1 atm total pressure. The partial pressure of sulfur dioxide was found to be 16.9 kPa .

(i) Write a balanced equation for the complete combustion of one mole of a thiol with n carbon atoms. [1]

(ii) Show that when a thiol with n carbon atoms is completely burnt in a stoichiometric amount of oxygen, the mole fraction of sulfur dioxide in the product mixture is $1/(2n+2)$. Assume that all products are gaseous. [1]

(iii) Use the above data, together with the information in (ii) to deduce the value of n for the thiol burnt in the experiment. [1]

(iv) Hence find the mass of thiol burnt. [2]

(b) Thiols are suitable starting materials for the synthesis of organic sulfides. An example is given below.

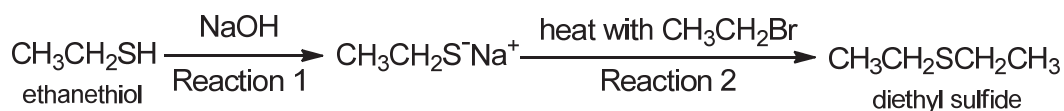

(i) How would the acid strength of ethanethiol compare to that of ethanol, given that Reaction 1 is effectively complete? [1]

(ii) State the type of reaction occurring in Reaction 2. [1]

(iii) Suggest why Reaction 1 was carried out in the above synthesis. [1]

(iv) Give **two** reasons to explain why ethylphenyl sulfide, $C_6H_5SCH_2CH_3$, cannot be obtained by changing bromoethane in Reaction 2 to bromobenzene. [2]

- (c) The following diagram shows a process which may be used for the removal and recovery of thiols from petroleum. The process utilizes the reaction between thiols and lead(II) oxide, as given in the equation below.



As the equilibrium position for Reaction I lies very much towards the products, the overall recovery of thiols in the process is high.

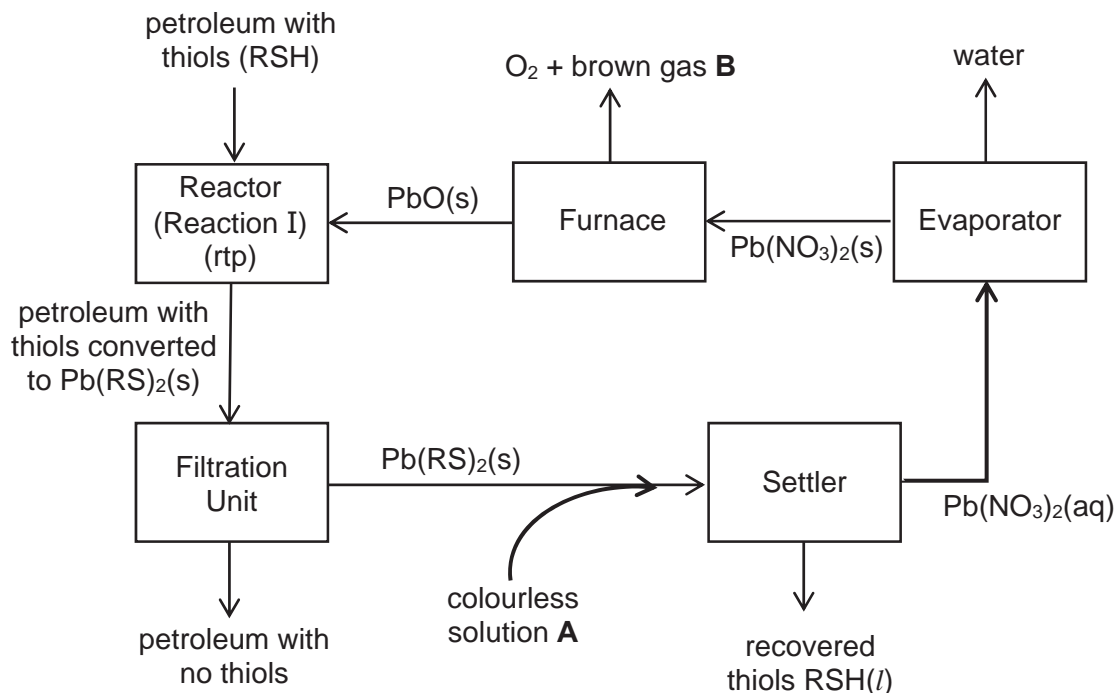

- (i) State the role of lead(II) oxide in Reaction I. [1]
- (ii) Comment on the sign and magnitude of ΔG^\ominus for Reaction I. [2]
- (iii) Suggest the identity of colourless solution **A** and brown gas **B**. [2]
- (iv) Suggest the temperature in the furnace, explaining your reasoning with the use of relevant data from the *Data Booklet*. For reference, copper(II) nitrate and barium nitrate decompose at 170 °C and 630 °C respectively. [4]

- (d) Thermal cracking, which is a process where large alkane molecules are broken down into smaller alkanes and alkenes, proceeds via a free radical mechanism.

The following are reactions which are thought to occur, using propane as the starting alkane.

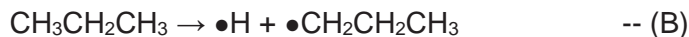

- (i) Reactions (A) and (B) are termed initiation steps. With the use of the *Data Booklet*, deduce which one is more likely to occur. [1]
- (ii) Of reactions (C) to (G), identify those which may be termed propagation steps in the mechanism. [1]
- (iii) Which gas, if detected in the product mixture, would offer support for the occurrence of both Reactions (B) and (D)? [1]
- (iv) Explain why Reaction (G) may be termed a disproportionation. [1]

[Total: 23]

3 Phosphorus forms a wide range of compounds that are essential for life and have many applications in the industry and in the laboratory.

- (a) Many detergents contain sodium dodecylbenzenesulfonate, $C_{18}H_{29}SO_3Na$ ($M_r = 348$), that can react with calcium ions in 'hard' water to give a precipitate, making the detergent ineffective.

The solubility product, K_{sp} , for $(C_{18}H_{29}SO_3)_2Ca(s)$ is given by

$$[Ca^{2+}][C_{18}H_{29}SO_3^-]^2 = 1.20 \times 10^{-17} \text{ mol}^3 \text{ dm}^{-9}$$

A particular brand of detergent contains 17.4% by mass of sodium dodecylbenzenesulfonate. The manufacturer states that in 'hard' water, 1.00 g of the detergent should be used with 1.00 dm³ of water. A typical sample of 'hard' water contains $2.50 \times 10^{-4} \text{ mol dm}^{-3}$ of Ca^{2+} .

You may assume that the volume of 1.00 g of detergent is negligible compared to 1.00 dm³ of 'hard' water.

- (i) Explain why it is not necessary to include the concentration of $(C_{18}H_{29}SO_3)_2Ca(s)$ in the K_{sp} expression. [1]
- (ii) Explain whether a precipitate will form when 1.00 g of the detergent is added to 1.00 dm³ of 'hard' water. [3]
- (iii) Calculate the maximum concentration of Ca^{2+} in 'hard' water for the detergent to be effective when it is used as recommended by the manufacturer. [1]

In order for detergents to be used in 'hard' water, sodium tripolyphosphate, $Na_5P_3O_{10}$, is added as a water softening agent. It 'softens' water by complexing with the calcium ions which can help to prevent the formation of precipitate.

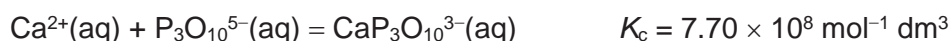

- (iv) Write an expression for the equilibrium constant of the above reaction. [1]
- (v) Some solid sodium tripolyphosphate was added to 'hard' water containing the detergent. After forming the complex, the concentration of $P_3O_{10}^{5-}$ decreased to **one-tenth** of its original value at equilibrium.

Using the K_c value, calculate the concentration of Ca^{2+} in the equilibrium mixture. [1]

- (vi) Hence, with reference to your answers in (a)(iii) and (a)(v), comment on whether the amount of solid sodium tripolyphosphate added was sufficient to make the detergent effective. [1]

(b) Phosphorus also forms a class of compounds with nitrogen known as phosphazenes.

A commercially available phosphazene is $(Cl_2PN)_3$ which is the starting material for many biomedical polymers. It can be synthesized by reacting PCl_5 with NH_4Cl . HCl is formed as a byproduct.

(i) Write an equation for the synthesis of $(Cl_2PN)_3$. [1]

(ii) $(Cl_2PN)_3$ has a cyclic backbone consisting of alternating phosphorus and nitrogen atoms. Each chlorine atom forms a single bond with a phosphorus atom.

Draw the structure of $(Cl_2PN)_3$. [1]

(iii) Like PCl_5 , $(Cl_2PN)_3$ undergoes a similar reaction with water, forming $(PN(OH)_2)_3$.

Suggest the type of reaction undergone by $(Cl_2PN)_3$ and predict what would be observed when a few drops of water was added to $(Cl_2PN)_3$. [2]

(iv) The atomic radii of P, N and Cl are listed in the *Data Booklet*.

State and explain the differences between the atomic radii of these three atoms. [2]

- (c) Many transition metal complexes contain phosphorus-containing ligands. An example is the Grubbs' catalyst that is used in alkene metathesis, a reaction that involves the redistribution of carbon-carbon double bonds.

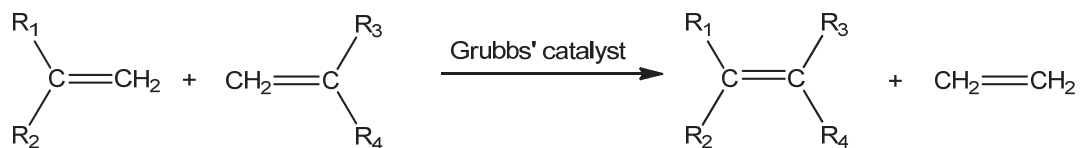

(R₁, R₂, R₃ and R₄ are alkyl groups)

The reaction scheme below shows the synthesis of compound **E** via alkene metathesis. Compound **A** is the only starting organic compound.

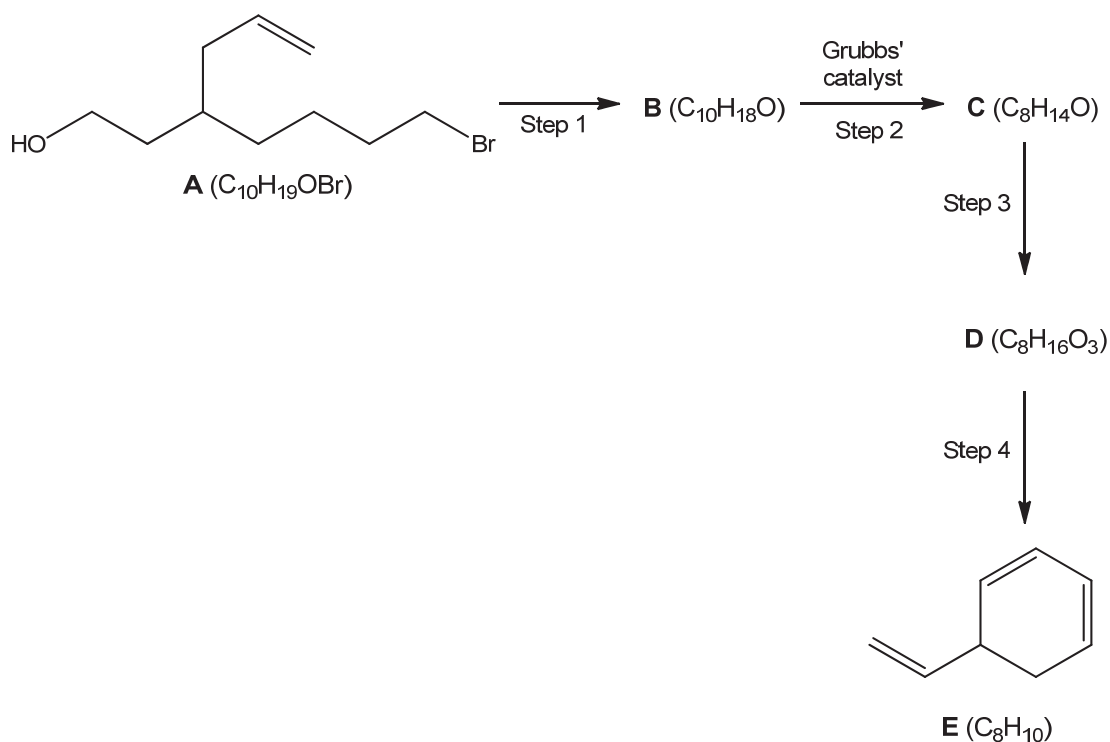

Compound **C** is a cyclic compound that reacts with one mole of PCl_5 . Compound **D** reacts with three moles of PCl_5 .

- (i) Draw the structures of compounds **B**, **C** and **D**. [3]
- (ii) State the reagents and conditions for Steps 1, 3 and 4. [3]

[Total: 20]

Section B

Answer **one** question from this section.

- 4 (a) Organic compounds like ethanol can be used as fuels in fuel cells.

In an ethanol fuel cell, an aqueous solution of ethanol undergoes oxidation at the anode, which is layered with a metal catalyst, to produce carbon dioxide gas and hydrogen ions, while oxygen undergoes reduction at the cathode.

- (i) Write a half equation for the reaction that occurs at the anode in the ethanol fuel cell. [1]
- (ii) Describe the mode of action of the metal catalyst that helps to increase the rate of reaction at the anode in the fuel cell. [4]
- (iii) Draw a fully labelled diagram of a separate electrochemical cell you would set up in order to measure the standard reduction potential, $E^{\ominus}_{\text{CO}_2/\text{ethanol}}$. [3]
- (iv) Deduce how $E^{\ominus}_{\text{CO}_2/\text{ethanol}}$ will change when the pH in the $\text{CO}_2/\text{ethanol}$ half-cell increases. [2]

- (b) **A**, $\text{C}_6\text{H}_8\text{O}_3$, is a fungal metabolite that is known to inhibit the formation of biofilms. To determine its identity, **A** was boiled in dilute HCl to give **B**, $\text{C}_6\text{H}_{10}\text{O}_4$.

- (i) The degree of unsaturation uses the molecular formula of an organic compound to find the number of double/ triple bonds or rings present in the compound. A double bond or a ring accounts for one degree of unsaturation, while a triple bond accounts for two degrees of unsaturation.

The degree of unsaturation for a compound $\text{C}_x\text{H}_y\text{O}_z$ is found using this expression:
 $\frac{1}{2}(2 + 2x - y)$.

Calculate the degree of unsaturation of **A** and of **B**. [2]

- (ii) Deduce the **functional groups** present in **B**. Provide supporting evidence from the information below.
- **B** reacts with Na_2CO_3 to give effervescence.
 - When **B** was warmed with alkaline $\text{I}_2(\text{aq})$, a yellow precipitate was observed.
 - No orange precipitate was formed upon reaction of **B** with 2,4-dinitrophenylhydrazine.
 - When **B** was heated with acidified $\text{K}_2\text{Cr}_2\text{O}_7$, it formed **C**, $\text{C}_6\text{H}_6\text{O}_4$. However, when acidified KMnO_4 was used instead, **D**, $\text{C}_5\text{H}_4\text{O}_5$ was produced.
 - Both **C** and **D** formed an orange precipitate when reacted with 2,4-dinitrophenylhydrazine. [3]
- (iii) By considering the reaction of **A** to give **B** and your answer in b(ii), deduce the identity of the functional group present in **A** that is **not** present in **B**. [1]

(iv) **A** was subjected to a series of tests. The observations are recorded in the table below.

Test	Observation
Br_2 (aq)	Yellow solution decolourised
SOCl_2	White fumes of HCl observed
I_2 , NaOH (aq), heat	No yellow ppt
2,4-dinitrophenylhydrazine	No orange ppt observed
Na_2CO_3 (aq)	No effervescence observed

Using all the information in (b), suggest the structures of **A**, **B**, **C** and **D**. [4]

[Total: 20]

- 5 Histidine is one of the essential amino acids that is present in many proteins and enzymes. It exists as a crystalline solid with a melting point of 282 °C. There are three pK_a values associated with histidine: 1.82, 6.00 and 9.17.

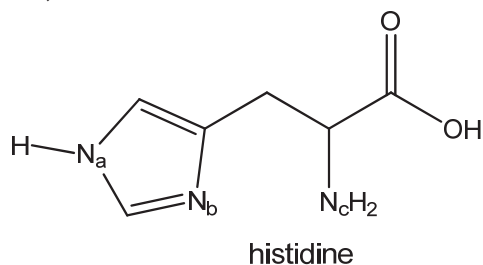

- (a) Account for the crystalline state and high melting point of histidine in terms of its structure and bonding. [3]
- (b) State the hybridisation of the nitrogen atom N_b and sketch a diagram showing all the hybrid orbitals around it. [2]
- (c) (i) In the fully protonated form of histidine, nitrogen atoms N_b and N_c are protonated. N_a is not considered basic.

Sketch the titration curve obtained when 20 cm³ of the fully-protonated form of histidine is titrated with 60 cm³ of NaOH(aq) of the same concentration. Your sketch should show clearly where the three pK_a values occur and mark the isoelectric point of histidine on your sketch with an "X". [3]

- (ii) Calculate the final pH, to 2 decimal places, of the resultant solution obtained when 10 cm³ of 0.010 mol dm⁻³ NaOH was added to 100 cm³ of a solution of 0.10 mol dm⁻³ histidine at pH 6.

You may represent the acid as HA and the conjugate base as A⁻ in your working. [3]

- (d) Compound **P** does not rotate plane-polarised light and is insoluble in both dilute hydrochloric acid and aqueous sodium hydroxide at room temperature. The following scheme shows reactions of compound **P** and its products.

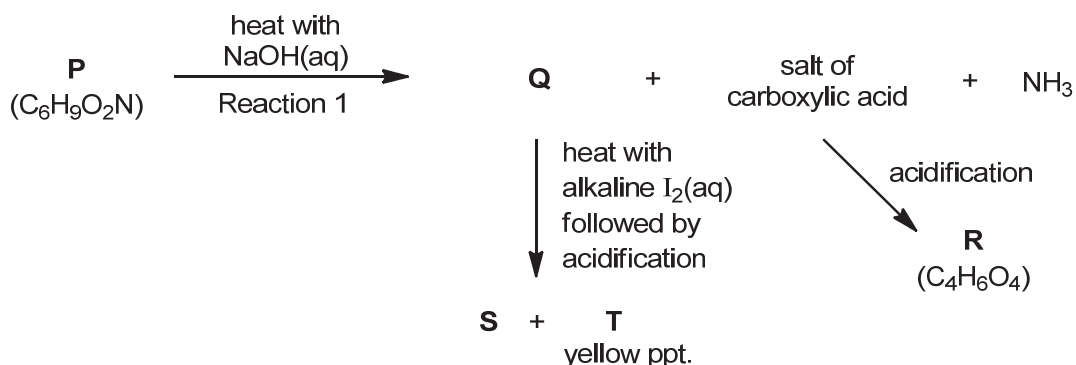

- (i) State the type of reaction that occurs in Reaction 1 and identify **two** possible functional groups in **P** which can produce ammonia in this reaction. [2]
- (ii) Draw the structures of compounds **P** to **T**. [5]
- (iii) On treatment of **P** with hydrogen and a platinum catalyst, compound **U**, C₆H₁₃NO₂, is produced. However, reaction of **P** with lithium aluminium hydride forms **Q** and compound **V**, C₄H₁₁NO. Both **Q** and **V** contain a common functional group. Suggest the structures of **U** and **V**. [2]

[Total: 20]



HWA CHONG INSTITUTION
C2 Preliminary Examination
Higher 2

NAME

CT GROUP

16S

CHEMISTRY

9729/04

Paper 4 Practical

25 August 2017

2 hours 30 minutes

Candidates answer on the Question Paper

READ THESE INSTRUCTIONS FIRST

Write your name and class on all the work you hand in.

Give details of the practical shift and laboratory where appropriate, in the boxes provided. Write in dark blue or black pen.

You may use an HB pencil for any diagrams or graphs.

Do not use staples, paper clips, glue or correction fluid.

Answer **all** questions in the spaces provided on the Question Paper.

The use of an approved scientific calculator is expected, where appropriate.

You may lose marks if you do not show your working or if you do not use appropriate units.

Qualitative Analysis Notes are printed on pages 15 and 16.

At the end of the examination, fasten all your work securely together.

The number of marks is given in brackets [] at the end of each question or part question.

Shift
Laboratory

For Examiner's Use	
1	
2	
3	
4	
Total	

Answer **all** the questions in the spaces provided.

1 Determination of concentrations of sodium hydroxide, and of sodium carbonate in a mixture

FA 1 is a solution containing sodium hydroxide, NaOH, and sodium carbonate, Na₂CO₃.

FA 2 is an aqueous solution containing 0.90 mol dm⁻³ of hydrochloric acid, HCl.

Sodium hydroxide reacts with hydrochloric acid according to the equation below:



Sodium carbonate reacts with hydrochloric acid in two separate stages. The reactions that occur are:

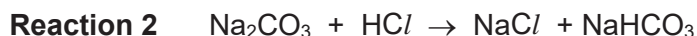

You are required to find the concentrations of sodium hydroxide, and of sodium carbonate, in **FA 1**, by means of a *double-indicator* titration.

In a *double-indicator* titration, **two different** indicators are used, separately, in the **same** titration. In this experiment, thymolphthalein indicator, followed by methyl orange indicator, will be used.

Thymolphthalein indicates the end-point when **Reaction 1** and **2** are complete, while methyl orange indicates the end-point when **Reaction 3** is complete.

(a) (i) Dilution of FA 2

Using a burette, measure between 35.00 cm³ and 36.00 cm³ of **FA 2** into the 250 cm³ volumetric flask.

Record your burette readings and the volume of **FA 2** added to the flask in the space below.

Make up the contents of the flask to the 250 cm³ mark with deionised water. Place the stopper in the flask and mix the contents thoroughly by slowly inverting the flask a number of times. This solution is **FA 3**.

(ii) Titration of FA 1 against FA 3

Fill a second burette with **FA 3**.

Pipette 25.0 cm³ of **FA 1** into a conical flask.

Replace the cap over the FA 1 bottle to prevent absorption of carbon dioxide from the atmosphere.

Add a few drops of thymolphthalein indicator and titrate **FA 1** with **FA 3**. The end-point is reached when the solution turns colourless. Ignore any cloudiness that you may observe in the conical flask. Record your titration results in the space below. **The volume of FA 3 used to reach the first end-point need not be consistent.**

Do not discard this solution.

To **this** solution, add a few drops of methyl orange indicator and **continue** to titrate with **FA 3** until the second end-point is reached. Record your titration results in the space below.

Perform sufficient titrations to obtain accurate results for the **second end-point**, which refers to the **total** volume of **FA 3** required for the whole titration.

Make certain that all your recorded results show the precision of your working.

[3]

(b) From your titrations, obtain suitable volumes of **FA 3** for the:

- first end-point
- second end-point.

Show clearly how you obtained these volumes.

volume of **FA 3** for first end-point =

volume of **FA 3** for second end-point =

[3]

--

- (c) (i) Calculate the concentration, in mol dm⁻³, of HCl in **FA 3**.

concentration of HCl in **FA 3** = [1]

- (ii) Calculate the amount of sodium carbonate, Na₂CO₃, present in 25.0 cm³ of **FA 1**.

amount of Na₂CO₃ in 25.0 cm³ of **FA 1** = [1]

- (iii) Calculate the amount of sodium hydroxide, NaOH, present in 25.0 cm³ of **FA 1**.

amount of NaOH in 25.0 cm³ of **FA 1** = [2]

- (iv) Use your answers from (c)(ii) and (c)(iii), calculate the concentrations, in mol dm⁻³, of Na₂CO₃ and NaOH in **FA 1**.

concentration of Na₂CO₃ in **FA 1** =

concentration of NaOH in **FA 1** =

[1]

- (d) The maximum error in a single burette reading is $\pm 0.05 \text{ cm}^3$.

When making up the diluted acid, **FA 3**, a student recorded that 35.00 cm^3 of **FA 2** was used. What are the smallest and largest possible volumes of acid that were run into the volumetric flask?

smallest volume used = cm^3 largest volume used = cm^3 [1]

- (e) A student suggested doing the titration in (a)(ii) differently – **FA 3** is placed in the conical flask and **FA 1** in the burette, using methyl orange indicator followed by thymolphthalein indicator.

Explain if this method will allow you to determine the concentrations of NaOH and Na_2CO_3 in **FA 1**.

.....
.....
.....[1]

[Total: 13]

2 Heat of reaction between copper(II) ions and iron metal

In this experiment, you will measure the heat given out by the reaction of excess iron with copper(II) sulfate solution and use this to find the concentration of the copper(II) sulfate.

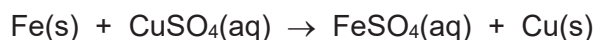

FA 4 is iron powder.

FA 5 is aqueous copper(II) sulfate, CuSO_4 .

In an appropriate format in the space below, prepare a table in which you may record each temperature and the time it was taken.

1. Wash thoroughly a burette and fill it with **FA 5**. Place a Styrofoam cup into a 250 cm³ beaker to prevent it from tipping over. Transfer 40.00 cm³ of **FA 5** into the Styrofoam cup.
2. Place the lid onto the cup and insert the thermometer through the lid. Measure and record the initial temperature of the **FA 5** solution in the cup.
3. Start the stopwatch. Measure and record the temperature of the solution in the cup **every half minute** up to and including the temperature at 1.5 min. Stir the solution using the thermometer.
4. At time $t = 2.0$ min, add all the powdered iron **FA 4** to the solution. Stir the mixture **thoroughly** with the thermometer to **ensure the solid mixes well with the solution**.
5. Record the temperature of the mixture **every minute** from $t = 2.5$ min. Continue stirring **thoroughly** and mixing the contents of the cup well **throughout** your recordings.
6. Once the temperature starts to drop, continue recording **every half minute** for a **further 3 minutes**. Constantly stir the solution **thoroughly**.

(a) Experimental Results

[4]

- (b) (i) Plot on the grid below, a graph of the temperature on the y-axis, against time, t , on the x-axis. The scale for the temperature axis must allow you to plot a point with temperature $5\text{ }^{\circ}\text{C}$ greater than the maximum temperature you recorded.

Draw the following **best-fit** straight lines on the graph.

- a line through the points before addition of **FA 4**.
- a line through the points once temperature starts to drop.

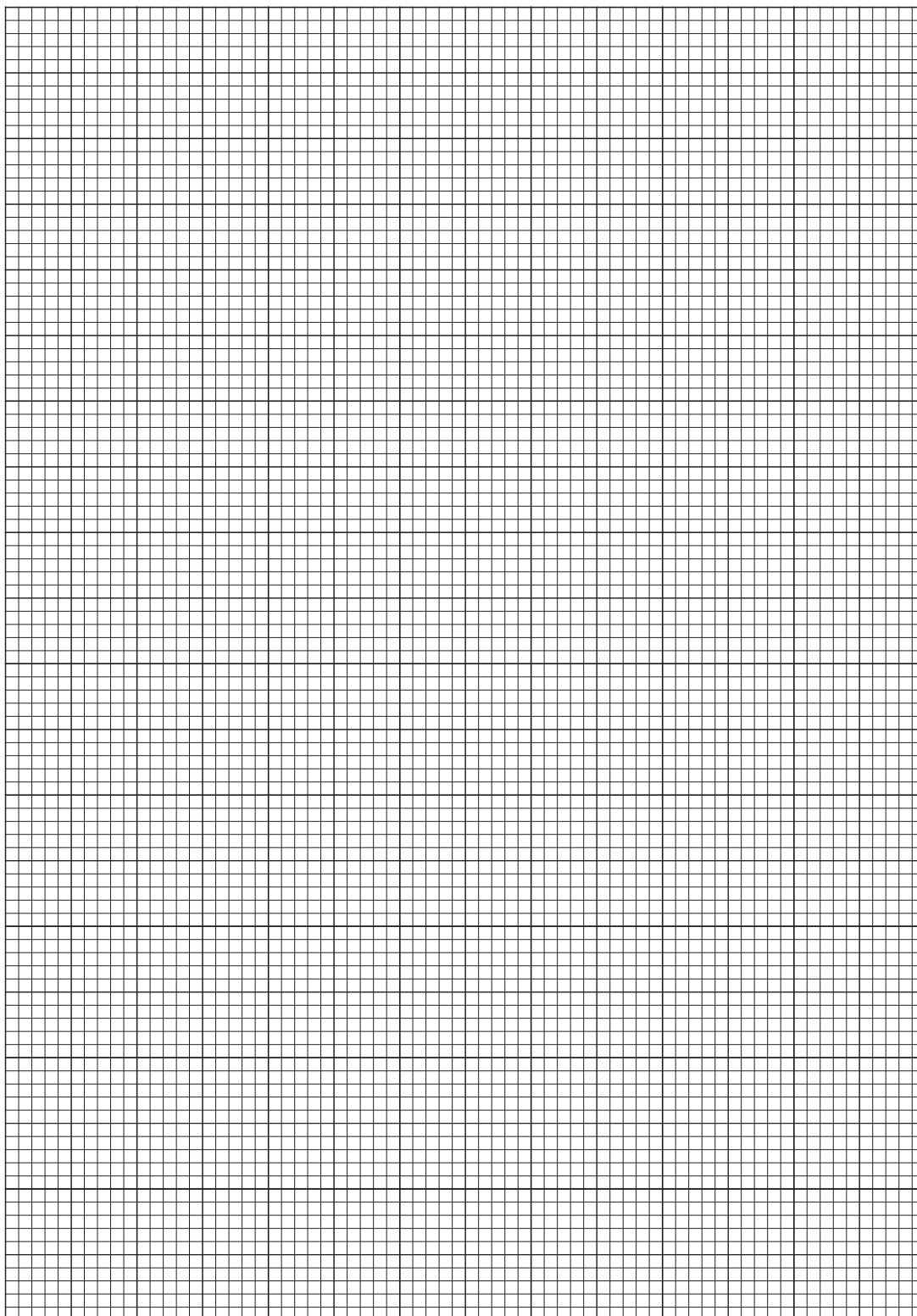

- (ii) Use the best-fit straight lines to determine the theoretical temperature change at time $t = 2.0$ min.

change in temperature = [5]

- (c) (i) Use your answer to (b)(ii) to calculate the heat energy produced in the reaction. (Assume that **4.2 J** are required to increase the temperature of 1 cm^3 of solution by 1°C .)

heat energy produced = [1]

- (ii) The molar enthalpy change, ΔH , for the reaction shown below is -152 kJ mol^{-1} .



Use this value and your answer to (c)(i) to calculate the concentration of copper(II) sulfate, in mol dm^{-3} , in **FA 5**.

concentration of copper(II) sulfate = [5]

- (d) (i) Calculate the maximum percentage error in the highest temperature that you recorded in your results table.

maximum percentage error = [1]

- (ii) What would be the expected change in temperature obtained in (b)(ii) if the volume of copper(II) sulfate used was halved? Explain your answer.

.....

.....

.....

.....[1]

[Total: 17]

3 Planning

The concentration of copper(II) sulfate in **FA 5** in Question 2 may be determined instead, by titration of the aqueous solution obtained after step 5, with aqueous potassium manganate(VII).

The reaction mixture obtained after step 5 in Question 2 contains $\text{FeSO}_4(\text{aq})$ and solids iron and copper. This mixture needs to be first filtered. The filtrate is then diluted to obtain a solution suitable for titration with aqueous potassium manganate(VII) of known concentration, in the presence of acid.

The manganate(VII) ions react with iron(II) ions as shown in the following equation.

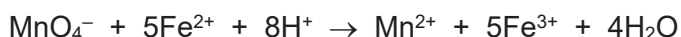

- (a) Using information from Question 2, determine a suitable concentration of aqueous potassium manganate(VII) to use in this titration. The concentration of manganate(VII) should not exceed $0.0500 \text{ mol dm}^{-3}$.

You are to assume that the concentration of copper(II) sulfate in **FA 5** is $0.800 \text{ mol dm}^{-3}$. (Note that this is not the correct value.)

Show clearly your calculations and any assumptions.

[3]

4 Qualitative analysis

In this question you will perform a series of test-tube reactions and use the observations to help you deduce the identities of two solids present in a given mixture **FA 6**.

You will also **devise a plan**, consisting of test-tube reactions, and **carry out** the plan to distinguish between three solutions **FA 9**, **FA 10** and **FA 11**, so that each is identified.

At each stage of any test you are to record details of the following:

- details of colour changes and precipitates formed
- the names of gases evolved and details of the test used to identify each one

You should indicate clearly at what stage in a test a change occurs.

No additional tests for ions present should be attempted.

- (a) **FA 6** is a mixture of two solids: **FA 7**, which is soluble in water and **FA 8**, which is insoluble in water. Each contains one cation and one anion listed in the Qualitative Analysis Notes on pages 15 and 16.

Carry out the following tests and record your observations in the table.

<i>test</i>		<i>observations</i>
(i)	Place all of the solid, FA 6 , into a boiling tube. Add 10 cm ³ of deionised water and shake to dissolve FA 7 . Filter the mixture, collecting the filtrate in a test-tube. Keep the filtrate for tests (ii) to (iv). Wash the residue, FA 8 , with deionised water. Collect the washings in the previous boiling tube. Keep the residue for tests (v) to (vii).	
(ii)	To a 1 cm depth of filtrate, FA 7 , in a test-tube, add aqueous sodium hydroxide. Carefully warm the mixture.	
(iii)	To a 1 cm depth of filtrate, FA 7 , in a test-tube, add aqueous ammonia.	
(iv)	To a 1 cm depth of filtrate, FA 7 , in a test-tube, add 5 drops of aqueous silver nitrate, followed by aqueous ammonia.	

	<i>test</i>	<i>observations</i>
(v)	Transfer half a spatula of the residue, FA 8 , into a clean boiling tube. Using a measuring cylinder, measure out 10 cm ³ of dilute nitric acid. Transfer the acid to the boiling tube in portions. Mix the contents of the boiling tube thoroughly. Filter if necessary. This solution is FA 12 .	
(vi)	To a 1 cm depth of FA 12 in a test-tube, add 1 cm depth aqueous edta.	
(vii)	To a 1 cm depth of FA 12 in a test-tube, add 1 cm depth aqueous sodium hydroxide, followed by aqueous ammonia. Do not discard the remaining FA 12. Keep the solution for (b).	

[4]

(viii) From the observations, identify the ions in **FA 7** and **FA 8**.

FA 7 contains the cation and the anion

FA 8 contains the cation and the anion

[2]

(ix) Explain in terms of the chemistry involved, your observations in **(a)(iv)**.

.....

 [2]

(x) State the type of reaction that occurred in **(a)(vi)**.

..... [1]

(b) Planning

FA 9, **FA 10** and **FA 11** each contains one of the following but not in that order:

hydrogen peroxide iron(II) sulfate potassium iodide

You are required to plan and **perform** a series of test-tube reactions using only **FA 9**, **FA 10**, **FA 11** and, **FA 12** from **(a)(v)**, to identify the three solutions, **FA 9** to **FA 11**.

You should commence your plan by adding **FA 12** to each of **FA 9**, **FA 10** and **FA 11**.

Each solution should be identified by at least one positive test. It is **not** sufficient to identify a solution simply by eliminating all the others.

You should aim to use the **minimum number** of reactions.

You may find it useful to consider the standard electrode potentials given below.

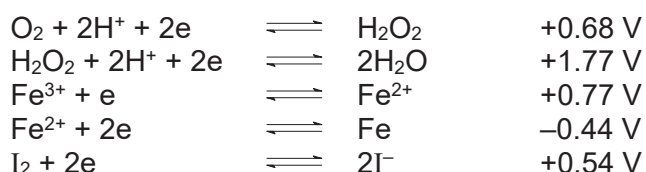

You may use the space below to plan your tests.

In the table in the next page, record

- details of the tests, including quantity of solutions used,
- observations of the tests,
- identities of the products that gave rise to the observations,
- identity of each solution.

.....

.....

.....

.....

.....

.....

.....

.....

.....

.....

.....

.....

.....

.....

.....

.....

.....

.....

.....

.....

.....

.....

.....

	<i>observations, identities of products and identity of each solution</i>		
<i>tests</i>	FA 9	FA 10	FA 11

Conclusion

Solution **FA 9** contains

Solution **FA 10** contains

Solution **FA 11** contains

 [8]
[Total: 17]

Qualitative Analysis Notes

[ppt. = precipitate]

(a) Reactions of aqueous cations

cation	reaction with	
	NaOH(aq)	NH ₃ (aq)
aluminium, Al ³⁺ (aq)	white ppt. soluble in excess	white ppt. insoluble in excess
ammonium, NH ₄ ⁺ (aq)	ammonia produced on heating	-
barium, Ba ²⁺ (aq)	no ppt. (if reagents are pure)	no ppt.
calcium, Ca ²⁺ (aq)	white ppt. with high [Ca ²⁺ (aq)]	no ppt.
chromium(III), Cr ³⁺ (aq)	grey-green ppt. soluble in excess giving dark green solution	grey-green ppt. insoluble in excess
copper(II), Cu ²⁺ (aq)	pale blue ppt. insoluble in excess	blue ppt. soluble in excess giving dark blue solution
iron(II), Fe ²⁺ (aq)	green ppt. turning brown on contact with air insoluble in excess	green ppt. turning brown on contact with air insoluble in excess
iron(III), Fe ³⁺ (aq)	red-brown ppt. insoluble in excess	red-brown ppt. insoluble in excess
magnesium, Mg ²⁺ (aq)	white ppt. insoluble in excess	white ppt. insoluble in excess
manganese(II), Mn ²⁺ (aq)	off-white ppt. rapidly turning brown on contact with air insoluble in excess	off-white ppt. rapidly turning brown on contact with air insoluble in excess
zinc, Zn ²⁺ (aq)	white ppt. soluble in excess	white ppt. soluble in excess

(b) Reactions of aqueous anions

<i>ion</i>	<i>reaction</i>
carbonate, CO_3^{2-}	CO_2 liberated by dilute acids
chloride, $\text{Cl}^-(\text{aq})$	gives white ppt. with $\text{Ag}^+(\text{aq})$ (soluble in $\text{NH}_3(\text{aq})$)
bromide, $\text{Br}^-(\text{aq})$	gives pale cream ppt. with $\text{Ag}^+(\text{aq})$ (partially soluble in $\text{NH}_3(\text{aq})$)
iodide, $\text{I}^-(\text{aq})$	gives yellow ppt. with $\text{Ag}^+(\text{aq})$ (insoluble in $\text{NH}_3(\text{aq})$)
nitrate, $\text{NO}_3^-(\text{aq})$	NH_3 liberated on heating with $\text{OH}^-(\text{aq})$ and Al foil
nitrite, $\text{NO}_2^-(\text{aq})$	NH_3 liberated on heating with $\text{OH}^-(\text{aq})$ and Al foil; NO liberated by dilute acids (colourless $\text{NO} \rightarrow$ (pale) brown NO_2 in air)
sulfate, $\text{SO}_4^{2-}(\text{aq})$	gives white ppt. with $\text{Ba}^{2+}(\text{aq})$ (insoluble in excess dilute strong acids)
sulfite, $\text{SO}_3^{2-}(\text{aq})$	SO_2 liberated on warming with dilute acids; gives white ppt. with $\text{Ba}^{2+}(\text{aq})$ (soluble in dilute strong acids)

(c) Test for gases

<i>gas</i>	<i>test and test result</i>
ammonia, NH_3	turns damp red litmus paper blue
carbon dioxide, CO_2	gives a white ppt. with limewater (ppt. dissolves with excess CO_2)
chlorine, Cl_2	bleaches damp litmus paper
hydrogen, H_2	"pops" with a lighted splint
oxygen, O_2	relights a glowing splint
sulfur dioxide, SO_2	turns aqueous acidified potassium manganate(VII) from purple to colourless

(d) Colour of halogens

<i>halogen</i>	<i>colour of element</i>	<i>colour in aqueous solution</i>	<i>colour in hexane</i>
chlorine, Cl_2	greenish yellow gas	pale yellow	pale yellow
bromine, Br_2	reddish brown gas / liquid	orange	orange-red
iodine, I_2	black solid / purple gas	brown	purple

You should have the following apparatus and chemicals.

Apparatus

2 x burette (50 cm³);
 1 x pipette (25.0 cm³);
 1 x pipette filler;
 1 x retort stand and burette clamp;
 2 x filter funnel;
 1 x white tile;
 2 x 250 cm³ conical flasks;
 1 x volumetric flask (250 cm³)
 1 x Styrofoam cup;
 1 x 250 cm³ beaker;
 1 x thermometer with range -5 °C to +50 °C, graduated to 0.2 °C;
 1 x stopwatch, reading to at least 0.1s;
 1 x 10 cm³ measuring cylinder;
 1 x Bunsen burner;
 1 x lighter (shared by 2 students);
 10 x test-tube;
 2 x boiling tube;
 1 x test-tube rack;
 1 x test-tube holder;
 1 x delivery tube with rubber stopper (fits boiling tube);
 1 x marker for writing on glass;
 1 x pair of disposable vinyl gloves;
 1 x pair of safety goggles;
 1 x wash bottle containing deionised water;
 A clear plastic bag containing:
 6 x plastic dropping pipettes;
 1 x lid for Styrofoam cup;
 1 x plastic spatula;
 1 x wooden splint;
 filter papers;
 litmus papers;
 paper towels.

Chemicals

Reagents labelled FA

FA 1
FA 2
FA 4
FA 5
FA 6
FA 9
FA 10
FA 11

Bench reagents

methyl orange
 thymolphthalein
 limewater
 dilute nitric acid
 aqueous ammonia
 aqueous silver nitrate
 aqueous sodium hydroxide
 aqueous edta (ethylenediaminetetraacetic acid)

1	D	2	C	3	C	4	B	5	D	6	B	7	A	8	B	9	C	10	D
11	D	12	D	13	A	14	D	15	A	16	C	17	B	18	C	19	B	20	B
21	C	22	A	23	A	24	C	25	D	26	A	27	B	28	B	29	A	30	D

HWA CHONG INSTITUTION
2017 C2 CHEMISTRY PRELIMINARY EXAMINATIONS
PAPER 2 MARK SCHEME

1

(a) (i)

	H ₂ (g)	+	I ₂ (g)	⇌	2HI(g)
Initial conc/ mol dm ⁻³	0.05		0.05		0
Change / mol dm ⁻³	- 0.03		- 0.03		+ 0.06
Eqm conc / mol dm ⁻³	0.02		0.02		0.06

$$K_c = \frac{[\text{HI}]^2}{[\text{H}_2][\text{I}_2]} \quad [1]$$

$$K_c = \frac{(0.06)^2}{(0.02)^2} = 9 \quad [1]$$

(ii)

	H ₂ (g)	+	I ₂ (g)	⇌	2HI(g)
Initial conc/ mol dm ⁻³	0.02		0.02		0.06
Change / mol dm ⁻³	+x		+x		-2x
Eqm conc / mol dm ⁻³	0.02+x		0.02+x		0.06-2x

$$K_c = \frac{(0.06 - 2x)^2}{(0.02 + x)^2} = 0.36$$

$$\frac{(0.06 - 2x)}{(0.02 + x)} = 0.6$$

$$x = 0.01846 \quad [1]$$

$$[\text{H}_2] = [\text{I}_2] = 0.02+x = \underline{\underline{0.0385 \text{ mol dm}^{-3}}}$$

$$[\text{HI}] = 0.06-2x = \underline{\underline{0.0231 \text{ mol dm}^{-3}}}$$

shown [1]

(iii)

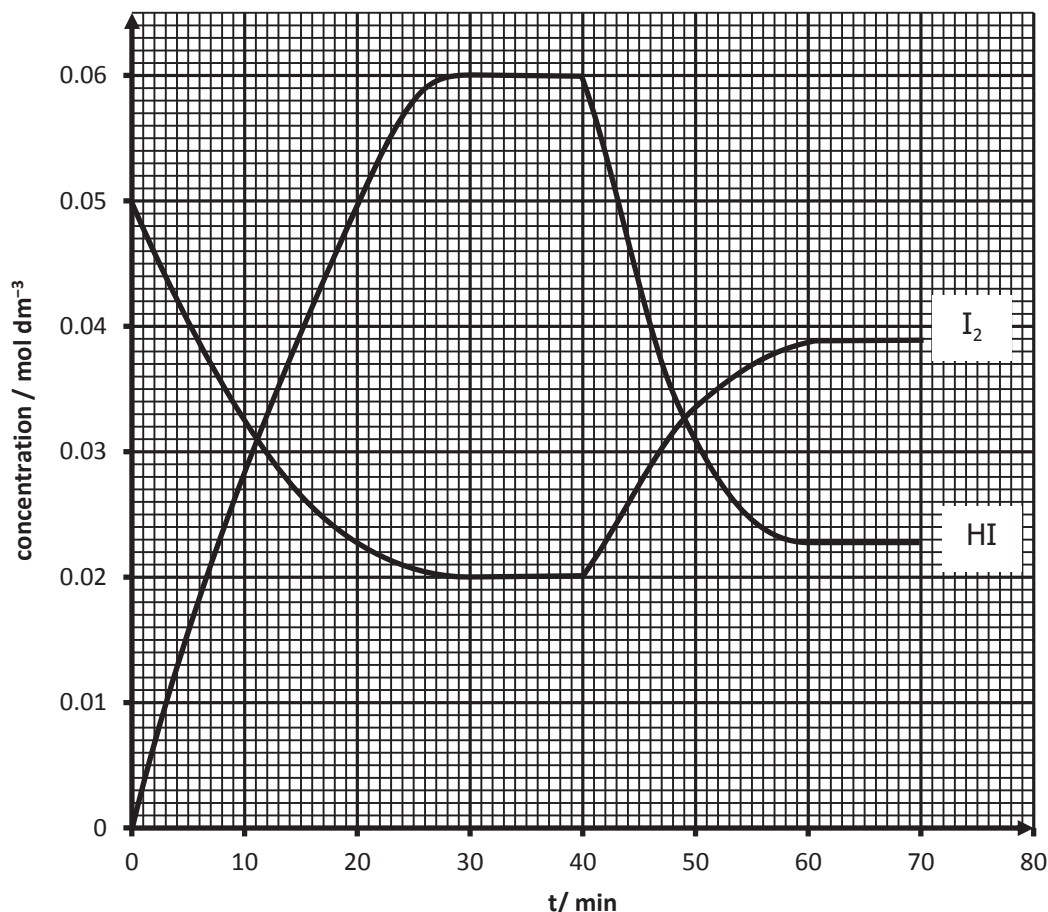

Correct axis labels [0.5]

Appropriate scale [0.5]

Correct shape of curves [0.5]

Horizontal lines from 30 – 40 mins and 60 – 70 mins [0.5]

*Correct concentration and time values for HI at t = 0, 30 and 60 min [1]

*Correct concentration and time values for I₂ at t = 0, 30 and 60 min [1]

*-[0.5] for every wrong plot

(iv) To prevent the position of equilibrium from shifting during the cooling process or when HI is removed when dissolved in water. [1]

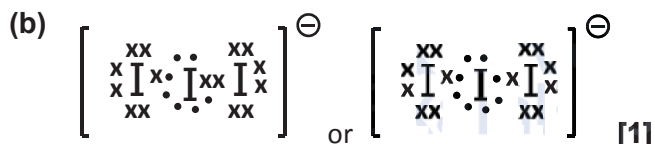

(c) Both I₂ and HI have simple molecular structure / consist of simple discrete molecules [0.5] held together by dispersion forces. However, I₂ has a larger number of electrons, therefore a larger electron cloud than HI, leading to stronger dispersion forces. [1]

So, a larger amount of heat energy [0.5] is needed to separate the molecules, leading to a higher boiling point.

2

- (a) (i) A ligand is an ion or molecule with one or more lone pairs of electrons available to be donated into the vacant orbitals of transition metal atom or ion.

(ii)

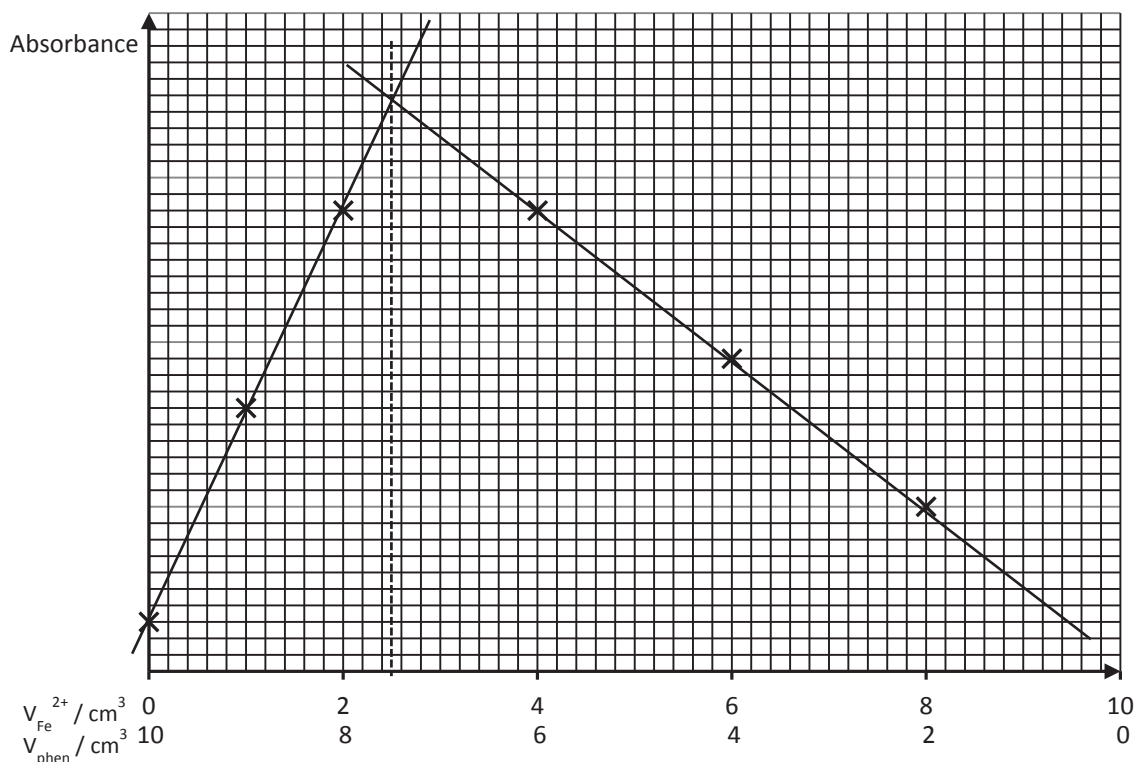

From the graph, $V_{\text{Fe}^{2+}}:V_{\text{phen}} = 2.5:7.5$ therefore you can deduce the following reacting ratio - Fe²⁺:phen is 1:3

Formula of the complex: **[Fe(phen)₃]²⁺**

- (iii)
- Fe²⁺ has an incomplete/ partially filled 3d subshell (insufficient to just give electronic configuration)
 - In the presence of ligands (phen), the degenerate 3d orbitals of Fe²⁺ split into two different energy levels with an energy gap ΔE
 - ΔE falls within the visible region of the electromagnetic spectrum
 - An electron in a lower energy d-orbital can absorb energy from the visible spectrum and be promoted to a higher energy d orbital that is vacant
 - The orange-red colour seen is the complement of the blue light absorbed.
- (iv) The energy gap, ΔE , is of a different magnitude in both complexes. Hence wavelength of light absorbed by the ferrozine complex is different from that absorbed by the phen complex and different colours are observed. (no need details on the exact colour of wavelength).

(b) (i) Reagent: $\text{CH}_3\text{CH}_2\text{Cl}$; condition: AlCl_3 , warm

(ii) Electrophilic substitution

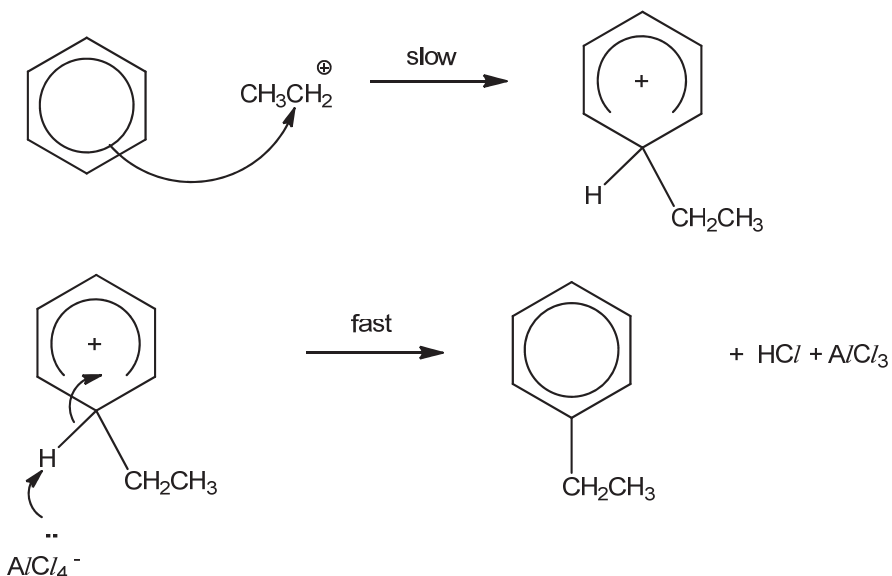

(c) (i)

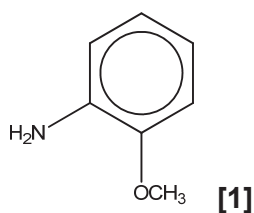

(ii) Accepted answers:

- 2,4-dinitrophenylhydrazine. Orange precipitate observed for vanillin but no precipitate for 4-VG
- Tollen's reagent with heating. Silver mirror observed for vanillin but no silver mirror for 4-VG
- Hot acidified KMnO_4 . Solution turns from purple to colourless for both but only 4-VG gives an effervescence that formed white ppt when passed through limewater
- Hot acidified $\text{K}_2\text{Cr}_2\text{O}_7$. Orange solution turned green for vanillin but solution remained orange for 4-VG.

3 (a) (i) hybridisation: sp^3 [1]

typical bond angle: 109.5° [1]

(ii) Forcing the bond angle in the epoxide ring to 60° brings electron pairs in the covalent bonds closer and they experience increased repulsion, weakening the C–O bonds and making them easier to break. [1]

or

After opening the ring, the resulting product is able to attain an optimal bond angle of 109.5° around the carbon atoms, minimising electron repulsion and eliminating the ring strain.

(b) (i)

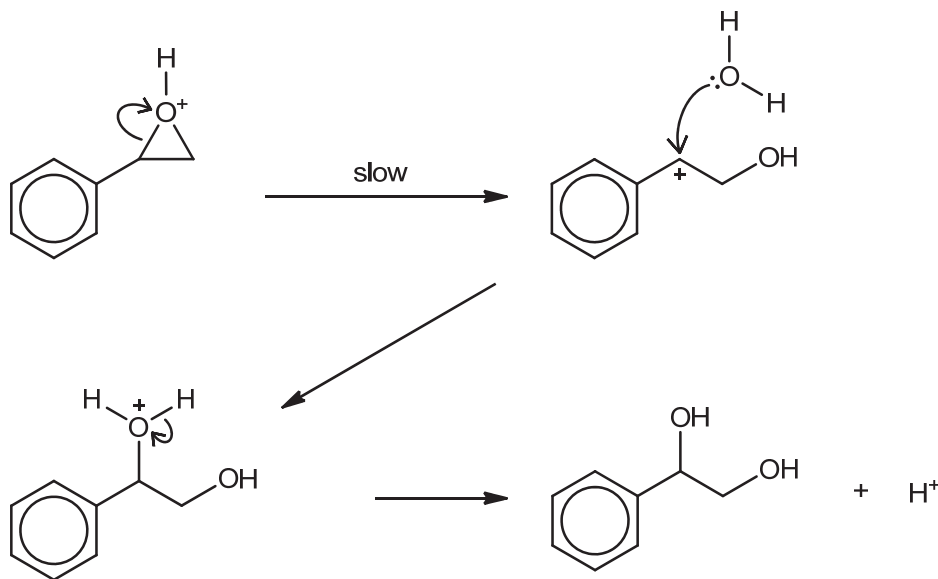

curly arrow from benzylic $\text{C}-\text{O}^+$ bond to O^+ [$\frac{1}{2}$], correct carbocation [$\frac{1}{2}$]
 curly arrow from lone pair on O in H_2O to C bearing the positive charge [$\frac{1}{2}$],
 correct intermediate formed [$\frac{1}{2}$]
 curly arrow from O^+-H bond to O^+ and H^+ regenerated [1]

(ii)

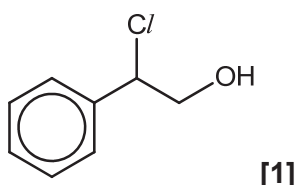

(iii) The other $\text{C}-\text{O}$ bond was broken instead, forming a primary carbocation intermediate. H_2^{18}O was then able to attack the primary carbocation to form isotopic isomer **A**. [1]

The primary carbocation formed is much more unstable than the secondary carbocation (which is particularly stable as it is resonance stabilised). The reaction mechanism is therefore much less likely to proceed via the 1° carbocation intermediate to form **A**. [1]

(c) step 1: conc HNO_3 , conc H_2SO_4 [$\frac{1}{2}$], maintained at 55°C or $< 55^\circ\text{C}$ [$\frac{1}{2}$]

step 2: $\text{KMnO}_4(\text{aq})$, $\text{H}_2\text{SO}_4(\text{aq})$, heat [1]

step 3: $\text{CH}_3\text{CH}_2\text{OH}$ (accept ethanol), few drops of conc H_2SO_4 , heat (under reflux) [1]

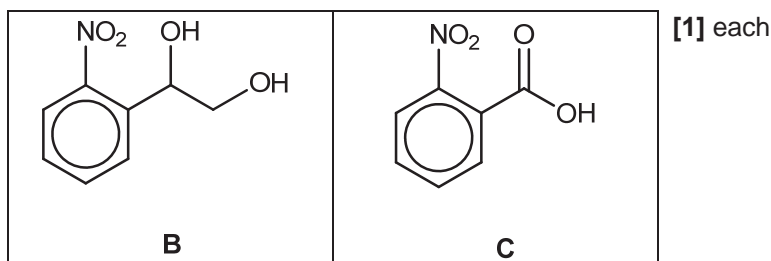

(d)

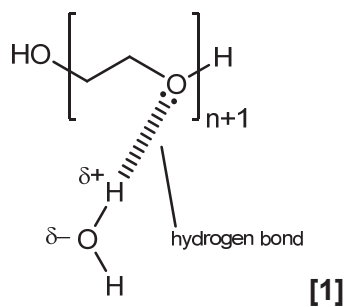

Extensive hydrogen bonding exists between PEG and water molecules. Energy released from this intermolecular hydrogen bonding with water is able to compensate for dispersion and p.d.-p.d. interactions between PEG, and intermolecular hydrogen bonding in water. **[1]**

4

(a) Carboxylic acid, aldehyde, ketone, alkene 4 x [1]

(b) (i)

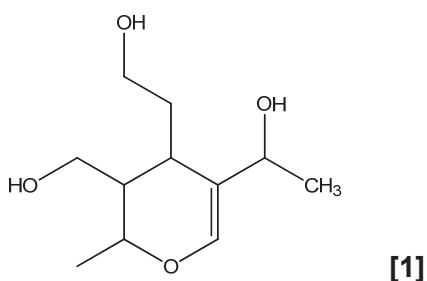

(ii)

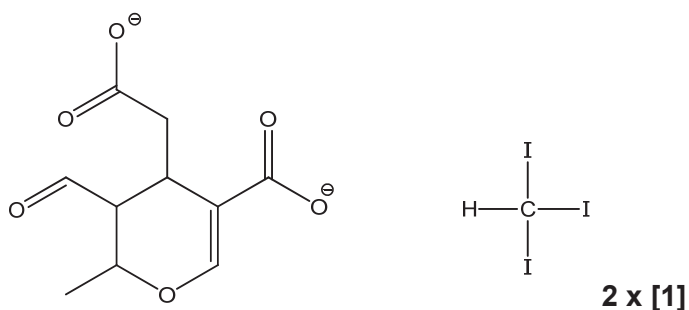

(iii)

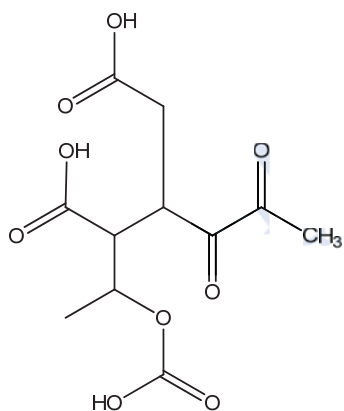

1 mark for correct structure for oxidative cleavage of C = C bond

1 mark for correct structure for the oxidation of -CHO to -CO₂H

- (c) Elenolic acid is a stronger acid / has higher acidity than compound M, which is a primary alcohol. [1]

The negative charge on the carboxylate ion (conjugate base of elenolic acid) is delocalised equally over two highly electronegative oxygen atoms. The negative charge is dispersed and the carboxylate ion is greatly stabilised. [1]

Whereas the electron-donating alkyl group intensifies the negative charge on the alkoxide ion (conjugate base of compound M) and the alkoxide ion is destabilised. [1]

5



(ii) $Q = 3100 \times 0.700 = 2170 \text{ C}$ [1]

Amount of electrons transferred = $(0.714/63.5) \times 2 = 0.02249 \text{ mol}$ [1]

Since $Q = \eta_e \times L \times e$

$2170 = 0.02249 \times L \times 1.60 \times 10^{-19}$

$L = 6.03 \times 10^{23} \text{ mol}^{-1}$ [1]

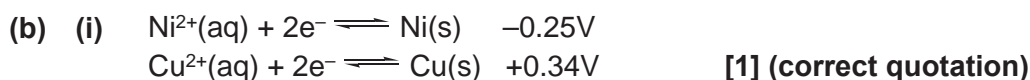

The reduction potential of the Cu^{2+}/Cu half cell is more positive than that of Ni^{2+}/Ni half cell and therefore Cu^{2+} will be preferentially reduced at the cathode. [1]



(iii) Upper

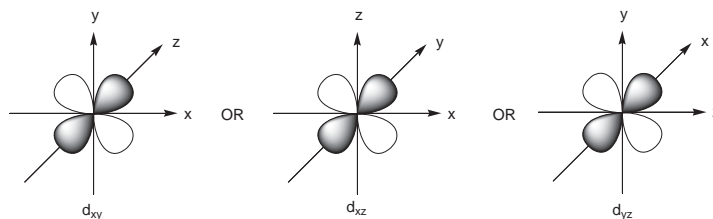

[1] for any of the three being drawn + correct label (shading not required; ignore if drawn)

Lower

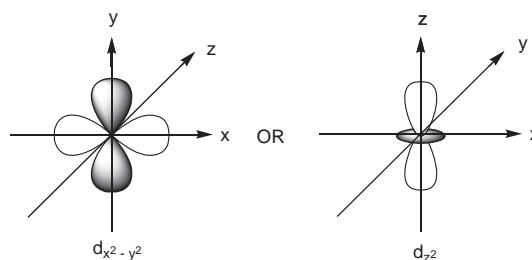

[1] for any of the two being drawn + correct label (shading not required; ignore if drawn)

(c) (i) From the graph, since the plot of k_{obs} against OH^- is a straight line that passes through the origin, $m=1$. [1]

(ii) Rate = $k[\text{OH}^-][\text{isocyanide}]$ [1]

When $[\text{OH}^-] = 0.74 \text{ mol dm}^{-3}$, $k_{obs} = 5.6 \times 10^{-3} \text{ s}^{-1}$
 rate = $k_{obs} [\text{isocyanide}] = 5.6 \times 10^{-3} \times (5.0 \times 10^{-4}) = 2.8 \times 10^{-6} \text{ mol dm}^{-3} \text{ s}^{-1}$ [1]

OR

Gradient for X=Cl graph, $k = 0.6 \times 10^{-3}/0.8 = 7.5 \times 10^{-3} \text{ mol dm}^{-3} \text{ s}^{-1}$
 rate = $k[\text{OH}^-][\text{isocyanide}] = 7.5 \times 10^{-3} \times 0.74 \times (5.0 \times 10^{-4}) = 2.8 \times 10^{-6} \text{ mol dm}^{-3} \text{ s}^{-1}$

(iii) The OH^- nucleophile approaches the electron deficient carbon of isocyanide. The substituents NO_2 and Cl are electron withdrawing and they enhance the electron deficiency of isocyanide, making it more susceptible to nucleophilic attack. Their rate of reaction (as reflected in the rate constant represented by the gradient) thus exceeds that when X=H (when there is no substituent). [1]

6

(a) A buffer solution is a solution that resists changes in pH upon addition of small amounts of acid or base. [1]

(b) $\text{pH} = \text{pK}_a + \lg \frac{[\text{SO}_3^{2-}]}{[\text{HSO}_3^-]} = -\lg(1.02 \times 10^{-7}) + \lg(1/4)$

$\text{pH} = 6.39$ [1]

(c) $\text{HSO}_3^- + \text{OH}^- \rightarrow \text{SO}_3^{2-} + \text{H}_2\text{O}$ [1]

(d) $K_{sp} = [\text{Mg}^{2+}][\text{OH}^-]^2$
 $5.66 \times 10^{-12} = (5 \div 405 \times 2) [\text{OH}^-]^2$
 $[\text{OH}^-] = 1.51 \times 10^{-5} \text{ mol dm}^{-3}$ [1]

$\text{pH} = 14 - \text{pOH} = 14 + \lg(1.51 \times 10^{-5})$
 $\text{pH} = 9.18$ shown. [1]

(e) Solution B [1]

(f) "Tea" appears earlier because the working pH range of 3-nitrophenol indicator (6.7-8.7) is lower than the pH at which white precipitate occurs (9.18). [1]

(g) Phenolphthalein [1]

2017 C2 Prelims Paper 3 Mark Scheme

1 (a) No. of moles of NaOH = $0.100 \times 26.50/1000 = 2.65 \times 10^{-3}$ mol

No. of moles of H₂SO₄ (in 25cm³) = $\frac{1}{2} \times 2.65 \times 10^{-3}$
 = **1.325×10^{-3} mol** [1/2]

No. of moles of H₂SO₄ (in 250cm³) = $1.35 \times 10^{-3} \times \mathbf{250/25.0}$ [1/2]
 = 0.01325 mol

No. of moles of H₂SO₄ reacted = $(0.425 \times 100/1000) - 0.01325$ [1/2]
 = 0.02925 mol

No. of moles of Cu₃(CO₃)₂(OH)₂ = $0.02925 \times \mathbf{1/3}$ [1/2]
 = 9.75×10^{-3} mol

Mass of azurite = $9.75 \times 10^{-3} \times \mathbf{344.5}$ [1/2]
 = 3.359 g

% by mass of pure azurite in the powdered rock = $3.359/3.70 \times 100\%$
 = 90.8% [1/2]

(b) (i) $x = 2$ [1]

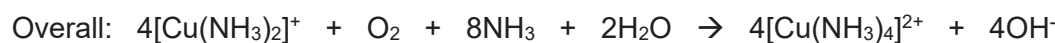
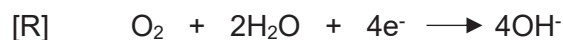
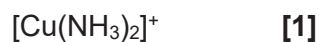

2 half-equations: [1/2 each]

Overall equation: [1]

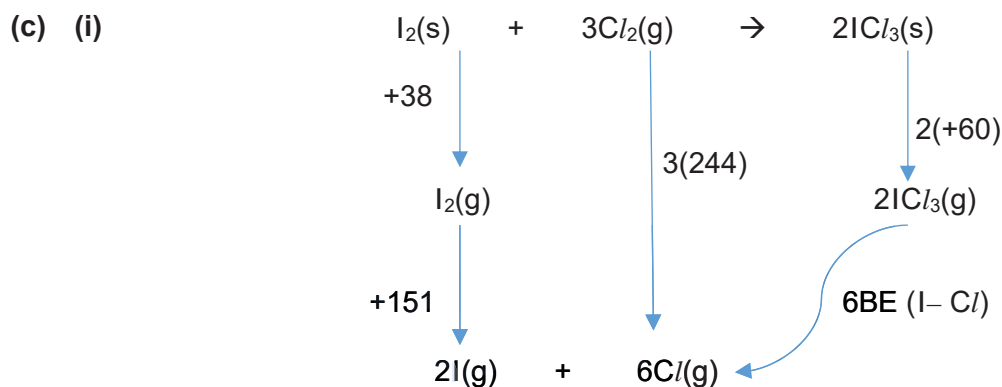

$$-162 = +38 + 151 + 3(244) - 6\text{BE(I-Cl)} - 120$$

$$\text{BE(I-Cl)} = +160.5 \text{ kJmol}^{-1}$$

energy cycle: [2]

application of Hess's Law: [1]

correct stoichiometry coefficients: [1]

(ii)

$$\begin{aligned}\Delta G_f^\ominus &= \Delta H_f^\ominus - T\Delta S_f^\ominus \\ -40.4 &= -81 - 298\Delta S_f^\ominus \\ \Delta S_f^\ominus &= -0.136 \text{ kJ mol}^{-1} \text{ K}^{-1} \\ &= -136 \text{ J mol}^{-1} \text{ K}^{-1}\end{aligned}\quad [1]$$

ΔS_f^\ominus is negative as there is a **decrease in the number of gaseous molecules**, resulting in **fewer number of ways** that the particles and the energy can be distributed. [1]

(d) (i) Electrophilic substitution, reduction and condensation.

[1 each] x 3

(ii)

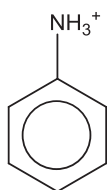
and $\text{CH}_3\text{CO}_2\text{H}$

[1/2 each]

- 2 (a) (i) $C_nH_{2n+1}SH + 3(n+1)/2 O_2 \rightarrow n CO_2 + SO_2 + (n+1)H_2O$ [1]
- (ii) $\chi_{SO_2} = \frac{\eta_{SO_2}}{\eta_{CO_2} + \eta_{SO_2} + \eta_{H_2O}} = 1/(n+1+n+1) = 1/(2n+2)$ shown [1]
- (iii) $\chi_{SO_2} = \frac{p_{SO_2}}{p_{total}}$
 $1/(2n+2) = 16900 / 101325$
 $n = 2$ [1]
- (iv) $\eta_{SO_2} = \frac{p_{SO_2} V}{RT} = \frac{16900(1.65 \times 10^{-3})}{8.31(110 + 273)} = 0.00876 \text{ mol} = \eta_{\text{ethanethiol reacted}}$ [1]
- Mass of ethanethiol = $0.00876 \times 62.1 = 0.544 \text{ g}$ [1]
- (b) (i) As Reaction 1 is effectively complete whereas ethanol does not react with NaOH, this shows that ethanethiol is a stronger acid than ethanol. [1]
- (ii) Nucleophilic substitution [1]
- (iii) Reaction 1 was carried out to generate $CH_3CH_2S^-$, a stronger nucleophile than CH_3CH_2SH . [1]
- (iv) For bromobenzene, the lone pair of electrons on the bromine atom is delocalised into the ring. As a result, there is partial double bond character to the C-Br bond, so its bond strength is higher than a typical C-Br in a halogenoalkane and it is very difficult to break. [1]
- Sterically, the rear side of the C-Br bond in bromobenzene is blocked by the benzene ring.
 Or
 The pi-electron cloud of the benzene ring will repel the lone pair of electrons of the incoming nucleophile, rendering attack of the nucleophile difficult. [1]
- (c) (i) Base [1]
- (c) (ii) As the equilibrium position lies towards the products ($K > 1$), ΔG^\ominus is negative. [1]
- As the equilibrium constant for Reaction 1 is a very large number, as $\Delta G^\ominus = -RT \ln K$, the magnitude of ΔG^\ominus is very large. [1]

- (iii) A: HNO₃ [1]
 B: NO₂ [1]

- (iv) The temperature in the furnace is 400 °C. [1] (accept any temperature between 170 °C and 630 °C)

The ionic radii of Cu²⁺, Pb²⁺ and Ba²⁺ are 0.073nm, 0.120nm and 0.135nm respectively. [1/2]

The charge density of the cation decreases from Cu²⁺ to Pb²⁺ to Ba²⁺. [1]

The polarising power of the cation decreases from Cu²⁺ to Pb²⁺ to Ba²⁺. OR the cation is less able to distort the electron cloud of the nitrate, weakening the N-O bonds within the nitrate anion to a smaller extent. [1]

Hence more energy is required to decompose Pb(NO₃)₂ compared to Cu(NO₃)₂ but less compared to Ba(NO₃)₂. [1/2] (accept “ease of decomposition” / “decomposition temperature”)

- (d) (i) Reaction (A) is more likely to occur as it is easier to break a C-C bond (350 kJ mol⁻¹) compared to a C-H bond (410 kJ mol⁻¹) [1]

- (ii) Reactions (C), (D) and (E) [1]

- (iii) Hydrogen [1]

- (iv) The •CH₂CH₃ radical loses a hydrogen (is oxidised) to form ethene and gains a hydrogen (is reduced) to form ethane. As it is both oxidised and reduced, this is a disproportionation. [1]

OR

The average oxidation number of carbon in the •CH₂CH₃ radical is -2.5, but -2 in ethene and -3 in ethane. As carbon is both oxidised and reduced, this is a disproportionation. [1]

3 (a) (i) Concentration of a solid is constant. [1]

(ii) $\eta(\text{C}_{18}\text{H}_{29}\text{SO}_3\text{Na})$ present in 1.00 g of detergent

$$= \left(\frac{17.4}{100} \times 1.00 \right) \div 348 = 5.00 \times 10^{-4} \text{ mol}$$

$$\therefore [\text{C}_{18}\text{H}_{29}\text{SO}_3^-] = 5.00 \times 10^{-4} \text{ mol dm}^{-3} \quad [1]$$

$$\text{IP} = (2.50 \times 10^{-4})(5.00 \times 10^{-4})^2 = 6.25 \times 10^{-11} \text{ mol}^3 \text{ dm}^{-9} \quad [1]$$

Since $\text{IP} > K_{\text{sp}}$, a precipitate will form. [1]

(iii) For the detergent to be effective, no precipitate is formed

$$\Rightarrow \text{IP} < K_{\text{sp}}$$

$$\therefore [\text{Ca}^{2+}][\text{C}_{18}\text{H}_{29}\text{SO}_3^-]^2 < 1.20 \times 10^{-17}$$

$$\text{From (a)(ii), } [\text{C}_{18}\text{H}_{29}\text{SO}_3^-] = 5.00 \times 10^{-4} \text{ mol dm}^{-3}$$

$$\therefore [\text{Ca}^{2+}] < \frac{1.20 \times 10^{-17}}{(5.00 \times 10^{-4})^2} = 4.80 \times 10^{-11} \text{ mol dm}^{-3}$$

$$\text{Maximum } [\text{Ca}^{2+}] = 4.80 \times 10^{-11} \text{ mol dm}^{-3} \quad [1]$$

$$\text{(iv)} \quad K_c = \frac{[\text{CaP}_3\text{O}_{10}^{3-}]}{[\text{Ca}^{2+}][\text{P}_3\text{O}_{10}^{5-}]} \quad [1]$$

$$\text{(v)} \quad K_c = \frac{[\text{CaP}_3\text{O}_{10}^{3-}]}{[\text{Ca}^{2+}][\text{P}_3\text{O}_{10}^{5-}]}$$

$$7.70 \times 10^8 = \frac{0.90}{[\text{Ca}^{2+}] \times 0.10}$$

$$[\text{Ca}^{2+}] = 1.17 \times 10^{-8} \text{ mol dm}^{-3} \quad [1]$$

(vi) Since $[\text{Ca}^{2+}]$ is **more than 4.80×10^{-11}** , the added solid sodium tripolyphosphate was **insufficient** to make the detergent effective. [1]

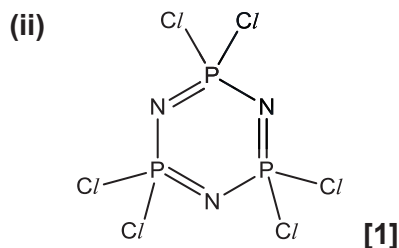
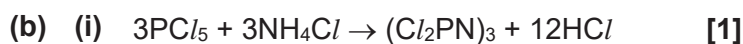

(iii) $(Cl_2PN)_3$ undergoes hydrolysis. [1] (Accept nucleophilic substitution)

White fumes of HCl is observed. [1]

(iv) From the Data Booklet, atomic radius of P = 0.110 nm, atomic radius of N = 0.074 nm and atomic radius of Cl = 0.099 nm

Atomic radius of N is the smallest as it has one less principle quantum shell than P and Cl and hence their valence electrons are closer to the nucleus. [1]

Atomic radius of Cl is smaller than P. Cl has higher nuclear charge / higher proton number but similar shielding effect [1] as P. Hence Cl has higher effective nuclear charge and the valence electrons are held closer to the nucleus.

(Idea of valence electron closer to nucleus just need to be mentioned once in answer).

Note: atomic radius of N must be compared to Cl. Explaining atomic radius of N < P and atomic radius of Cl < P does not fully explain the trend atomic radius of N < Cl < P.

(c) (i)

B =

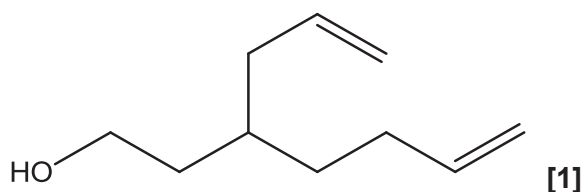

C =

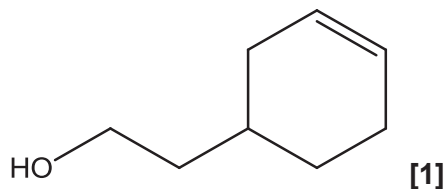

D =

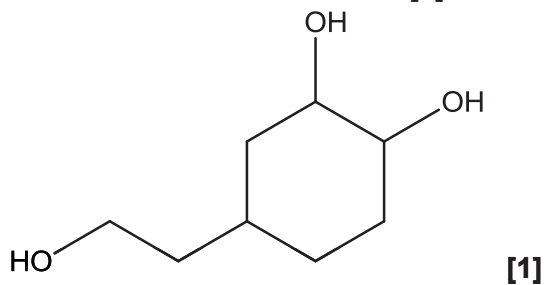

(ii) Step 1: alcoholic KOH, heat or alcoholic NaOH, heat [1]

Step 3: $KMnO_4$, $NaOH(aq)$, cold [1]

Step 4: excess concentrated H_2SO_4 , heat or concentrated H_3PO_4 , heat or Al_2O_3 , heat [1]

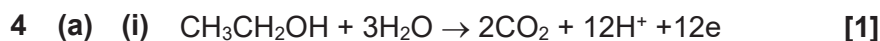

- (ii)
- Reactant molecules diffuse towards the catalyst surface and are **adsorbed onto the active sites**.
 - The **bonds in the reactant molecules weaken**, and the **activation energy is lowered**.
 - Reactant molecules are **brought closer together**, and are **correctly orientated**.
 - When the product is formed, it **desorbs** and diffuses away from the catalyst surface **freeing up the active sites**.

[4]

- (iii)
- Correctly drawn CO_2 / ethanol half cell
 - $[\text{H}^+]$ and ethanol to 1mol dm^{-3}
 - Temperature and pressure of CO_2 to 298K and 1 bar
 - Electrode: graphite/ metal catalyst/ platinum (coated with metal catalyst)
 - Correctly drawn standard hydrogen electrode
 - $[\text{H}^+]$ to 1mol dm^{-3}
 - Temperature and pressure of H_2 to 298K and 1 bar
 - Platinum electrode
 - Salt bridge and voltmeter

[1] for each point

- (iv)
- When pH increases, **$[\text{H}^+]$ decreases**. This **favours the oxidation** of ethanol.
 - Reduction potential should become **more negative**. [2]

- (b) (i) Degree of unsaturation of **A** = 3
Degree of unsaturation of **B** = 2 [2]

- (ii)
- **Carboxylic acid**
 - reacts with Na_2CO_3 in an acid-carbonate reaction.
 - **(Two) 2° alcohol**

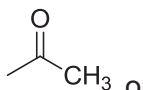
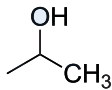
- oxidation with I_2 , $\text{NaOH}(\text{aq})$, suggest that either  or  is present. Since **B** does not react with 2, 4 – DNPH, a 2° alcohol is present
- oxidation with $\text{K}_2\text{Cr}_2\text{O}_7$ does not increase the number of oxygen atoms in C. No primary alcohol was oxidized.

- **(Terminal) Alkene**
 - Oxidative cleavage with KMnO_4 .
 - Oxidative cleavage causes the molecule to lose one carbon.

[3]

(b) (iii) • Since **B** contains a carboxylic acid and alcohol and is formed from the acid hydrolysis of **A**, **A** contains an **ester functional group**. [1]

(iv) • Of the two secondary alcohols, it is the secondary alcohol with the CH_3 that forms the ester since **A** does not give a yellow ppt with alkaline $\text{I}_2(\text{aq})$

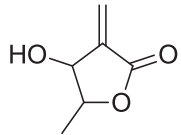
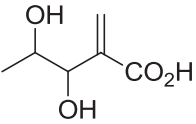
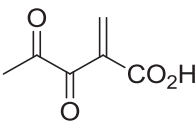
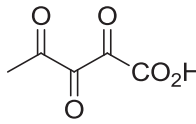
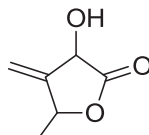
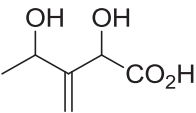
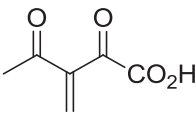
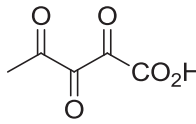
A	B	C	D
			
			

[1] each

- 5 (a) Histidine exists as zwitterions due to the internal neutralization of amino and carboxylic acid groups. **Zwitterions** are **arranged in an orderly manner** in solid crystalline state. [1]

It has a **giant ionic structure with strong ionic bonds** between the zwitterions.

[1] both

A lot of energy is required to separate the zwitterions due to the **strong** ionic bonds, thus it has high melting point. [1]

- (b) sp^2

[1]

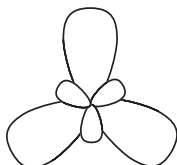

[1]

- (c) (i)

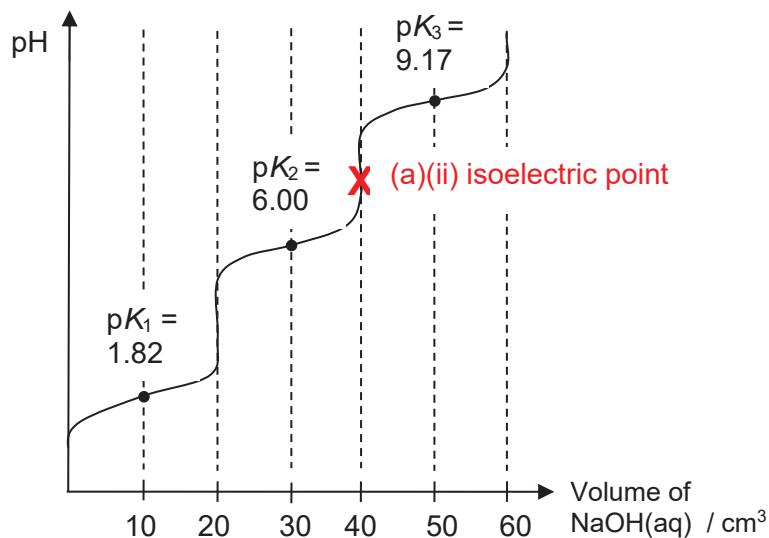

[1] axis labels and shape of curve

[1] 3 equivalence points at correct volumes & mark pK_1 , pK_2 & pK_3

[1] Mark X at the correct volume

- (c) (ii) $\text{pH} = \text{p}K_{\text{a}2} + \lg \frac{[\text{A}^-]}{[\text{HA}]}$
 $6 = 6.00 + \lg \frac{[\text{A}^-]}{[\text{HA}]}$
 $\frac{[\text{A}^-]}{[\text{HA}]} = 1$

Before addition of OH^-

Amount of histidine present = $0.100 \text{ dm}^3 \times 0.10 \text{ mol dm}^{-3} = 0.01 \text{ mol}$

Amount of HA = Amount of $\text{A}^- = 0.01 \times \frac{1}{2} = \underline{0.00500 \text{ mol}}$

On addition of OH^- :

Amount of OH^- -added = $0.01 \text{ dm}^3 \times 0.01 \text{ mol dm}^{-3} = 0.0001 \text{ mol}$

	HA	+ $\text{OH}^-(\text{aq})$	\rightleftharpoons	$\text{A}^-(\text{aq})$	+ H_2O
Before adding NaOH	0.00500			0.00500	
After adding NaOH	$0.00500 - 0.0001$ $= 0.00490$			$0.00500 + 0.0001$ $= 0.00510$	

$$\text{pH} = 6.00 + \lg (0.00510/0.00490)$$

$$= \underline{6.017 \approx 6.02}$$

[1] for original $[\text{A}^-]/[\text{HA}]$

[1] for amount of A^- & HA before addition of NaOH

[1] pH with 2 dp

- (d) (i) (Alkaline) Hydrolysis

[1] reject acid hydrolysis

Amide and nitrile

[1/2 each]

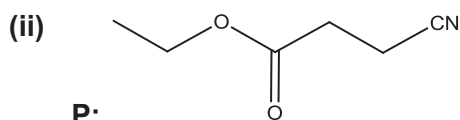

P:

Q: $\text{CH}_3\text{CH}_2\text{OH}$

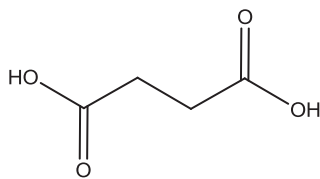

R:

S: HCO_2H

T: CHI_3

[1] each

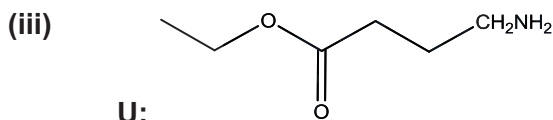

U:

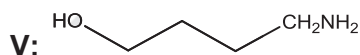

V:

[1] each

2017 HCI C2 H2 Chemistry Prelim Paper 4 Preparation Instructions

Safety

Supervisors are advised to remind candidates that **all** substances in the examination should be treated with caution. Only those tests described in the Question Paper should be attempted.

Attention is drawn in particular, to certain materials used in the examination. The following codes are used where relevant.



- Explosives
- Self-Reactives
- Organic peroxides



- Acute Toxicity (severe)



- Flammables
- Self Reactives
- Pyrophorics
- Self-Heating
- Emit Flammable Gas
- Organic Peroxides



- Irritant
- Dermal Sensitizer
- Acute toxicity (harmful)
- Narcotic Effects
- Respiratory Tract Irritation



- Oxidisers



- Carcinogen
- Respiratory Sensitizer
- Reproductive Toxicity
- Target Organ Toxicity
- Mutagenicity
- Aspiration Toxicity



- Gases Under Pressure



- Environmental Toxicity



- Corrosives

'Hazard Data Sheets', relating to materials used in this examination, should be available from your chemical supplier.

Before the Examination

1 Preparation of materials

Where quantities are specified for each candidate, they are sufficient for the experiments described in the Question Paper to be completed.

In preparing materials, the bulk quantity for each substance should be increased by 25% as spare material should be available to cover accidental loss. More material may be supplied if requested by candidates, without penalty.

All solutions should be bulked and mixed thoroughly before use to ensure uniformity.

2 Labelling of materials

Materials must be labelled as specified in these instructions. Materials with an **FA** code number should be so labelled **without** the identities being included on the label. Where appropriate the identity of an **FA** coded chemical is given in the Question Paper itself.

3 Identity of materials

It should be noted that descriptions of solutions given in the Question Paper may not correspond exactly with the specifications in these Instructions. **The candidates must assume the descriptions given in the Question Paper.**

Apparatus

1 For each candidate

- 2 x burette (50 cm³);
- 1 x pipette (25.0 cm³);
- 1 x pipette filler;
- 1 x retort stand and burette clamp;
- 2 x filter funnel;
- 1 x white tile;
- 2 x 250 cm³ conical flasks;
- 1 x volumetric flask (250 cm³)
- 1 x Styrofoam cup;
- 1 x 250 cm³ beaker;
- 1 x thermometer with range –5 °C to +50 °C, graduated to 0.2 °C;
- 1 x stopwatch, reading to at least 0.1s;
- 1 x 10 cm³ measuring cylinder;
- 1 x Bunsen burner;
- 1 x lighter (shared by 2 students);
- 10 x test-tube;
- 2 x boiling tube;
- 1 x test-tube rack;
- 1 x test-tube holder;
- 1 x delivery tube with rubber stopper (fits boiling tube);
- 1 x marker for writing on glass;
- 1 x pair of disposable vinyl gloves;
- 1 x pair of safety goggles;
- 1 x wash bottle containing deionised water;
- A clear plastic bag containing:
 - 6 x plastic dropping pipettes;
 - 1 x lid for Styrofoam cup;
 - 1 x plastic spatula;
 - 1 x wooden splint;
 - filter papers;
 - litmus papers;
 - paper towels.

FA reagents (1 set for every candidate)

hazard	label	per candidate	identity	notes
	FA 1	150 cm ³	0.0625 mol dm ⁻³ NaOH + 0.05 mol dm ⁻³ Na ₂ CO ₃ (anhydrous)	
	FA 2	80 cm ³	0.9 mol dm ⁻³ HCl	
	FA 4	1.5 g	Fe powder (as purchased)	
	FA 5	100 cm ³	0.400 mol dm ⁻³ CuSO ₄ (5 hydrate)	
	FA 6	2 g	50:50 solid sodium chloride & solid copper carbonate basic mixture	NaCl is used as "substitute" for BaCl ₂
	FA 9	10 cm ³	5% w/v acidified ferrous sulfate (7 hydrate) (in equal volume of 1M H ₂ SO ₄ and DI water)	
	FA 10	10 cm ³	3% H ₂ O ₂	
	FA 11	10 cm ³	5% w/v KI	

Bench reagents (1 set per seat for 3 shifts)

hazard	label	per candidate	identity
	lime water	2 cm ³ per shift	saturated calcium hydroxide, Ca(OH) ₂
	nitric acid	10 cm ³ per shift	2 mol dm ⁻³
	aqueous ammonia	25 cm ³ per shift	2 mol dm ⁻³
	aqueous sodium hydroxide	10 cm ³ per shift	2 mol dm ⁻³
	aqueous silver nitrate	5 drops per shift	0.05 mol dm ⁻³
	aqueous EDTA (sodium salt) (ethylenediaminetetraacetic acid)	2 cm ³ per shift	168.0 g C ₁₀ H ₁₄ N ₂ O ₈ Na ₂ in 1 dm ³ or 186.0g C ₁₀ H ₁₄ N ₂ O ₈ Na ₂ .2H ₂ O in 1 dm ³
	methyl orange indicator	10 drops per shift	as purchased
	thymolphthalein indicator	10 drops per shift	2 g in 1 dm ³ ethanol

Answer **all** the questions in the spaces provided.

1 Determination of concentrations of sodium hydroxide, and of sodium carbonate in a mixture

FA 1 is a solution containing sodium hydroxide, NaOH, and sodium carbonate, Na₂CO₃.

FA 2 is an aqueous solution containing 0.90 mol dm⁻³ of hydrochloric acid, HCl.

Sodium hydroxide reacts with hydrochloric acid according to the equation below:

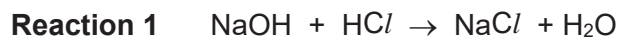

Sodium carbonate reacts with hydrochloric acid in two separate stages. The reactions that occur are:

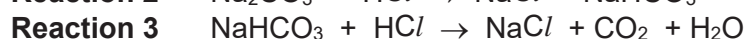
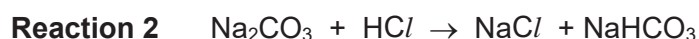

You are required to find the concentrations of sodium hydroxide, and of sodium carbonate, in **FA 1**, by means of a *double-indicator* titration.

In a *double-indicator* titration, **two different** indicators are used, separately, in the **same** titration. In this experiment, thymolphthalein indicator, followed by methyl orange indicator, will be used.

Thymolphthalein indicates the end-point when **Reaction 1** and **2** are complete, while methyl orange indicates the end-point when **Reaction 3** is complete.

(a) (i) Dilution of FA 2

Using a burette, measure between 35.00 cm³ and 36.00 cm³ of **FA 2** into the 250 cm³ volumetric flask.

Record your burette readings and the volume of **FA 2** added to the flask in the space below.

Final (burette) reading /cm ³	46.30
Initial (burette) reading / cm ³	11.00
Volume of FA2 (used for dilution) /cm ³	35.30

Make up the contents of the flask to the 250 cm³ mark with deionised water. Place the stopper in the flask and mix the contents thoroughly by slowly inverting the flask a number of times. This solution is **FA 3**.

(ii) Titration of FA 1 against FA 3

Fill a second burette with **FA 3**.

Pipette 25.0 cm³ of **FA 1** into a conical flask.

Replace the cap over the FA 1 bottle to prevent absorption of carbon dioxide from the atmosphere.

Add a few drops of thymolphthalein indicator and titrate **FA 1** with **FA 3**. The end-point is reached when the solution turns colourless. Ignore any cloudiness that you may observe in the conical flask. Record your titration results in the space below. **The volume of FA 3 used to reach the first end-point need not be consistent.**

Do not discard this solution.

To **this** solution, add a few drops of methyl orange indicator and **continue** to titrate with **FA 3** until the second end-point is reached. Record your titration results in the space below.

Perform sufficient titrations to obtain accurate results for the **second end-point**, which refers to the **total** volume of **FA 3** required for the whole titration.

Make certain that all your recorded results show the precision of your working.

Initial (burette) reading /cm ³	4.90	4.30
Final (burette) reading 1 /cm ³	24.60	24.10
Final (burette) reading 2 / cm ³	35.50	34.90
Titre 1 /cm ³	19.70	19.80
Titre 2 /cm ³	30.60	30.60

Tables have correct headers and units [1]

All readings recorded to correct precision [1]

Dilutes between 35.00 cm³ and 36.00 cm³ of **FA 2**. [1]

[3]

(b) From your titrations, obtain suitable volumes of **FA 3** for the:

- first end-point
- second end-point.

Show clearly how you obtained these volumes.

$$\text{mean titre 1} = \frac{1}{2} (19.70 + 19.80) = 19.75 \text{ cm}^3$$

$$\text{mean titre 2} = \frac{1}{2} (30.60 + 30.60) = 30.60 \text{ cm}^3$$

Correct average titre from values within 0.10 cm³ [1]

Accuracy (difference between teacher's and student's scaled mean titre) [2]

volume of **FA 3** for first end-point =

volume of **FA 3** for second end-point =

[3]

--

- (c) (i) Calculate the concentration, in mol dm⁻³, of HCl in **FA 3**.

$$[\text{HCl}] \text{ in FA3} = 35.30 / 250 \times 0.90 = 0.127 \text{ mol dm}^{-3}$$

concentration of HCl in **FA 3** = [1]

- (ii) Calculate the amount of sodium carbonate, Na₂CO₃, present in 25.0 cm³ of **FA 1**.

$$\begin{aligned} \text{vol. FA3 reacted with NaHCO}_3 \text{ formed} &= 30.60 - 19.75 \\ &= 10.85 \text{ cm}^3 \end{aligned}$$

$$\begin{aligned} \eta \text{Na}_2\text{CO}_3 \text{ in 25 cm}^3 \text{ FA 1} \\ &= \eta \text{NaHCO}_3 \text{ formed} \\ &= \eta \text{HCl reacted} \\ &= 0.1271 \times 10.85/1000 \\ &= 0.00138 \text{ mol} \end{aligned}$$

amount of Na₂CO₃ in 25.0 cm³ of **FA 1** = [1]

- (iii) Calculate the amount of sodium hydroxide, NaOH, present in 25.0 cm³ of **FA 1**.

$$\begin{aligned} \text{vol. FA3 reacted with NaOH} &= 19.75 - 10.85 \\ &= 8.90 \text{ cm}^3 \quad [1] \end{aligned}$$

$$\begin{aligned} \eta \text{NaOH in 25 cm}^3 \text{ FA 1} &= \eta \text{HCl reacted} \\ &= 0.1271 \times 8.90/1000 = 0.00113 \text{ mol} \quad [1] \end{aligned}$$

amount of NaOH in 25.0 cm³ of **FA 1** = [2]

- (iv) Use your answers from (c)(ii) and (c)(iii), calculate the concentrations, in mol dm⁻³, of Na₂CO₃ and NaOH in **FA 1**.

$$[\text{Na}_2\text{CO}_3] \text{ in FA 1} = 0.001379 \times 1000/25 = 0.0552 \text{ mol dm}^{-3}$$

$$[\text{NaOH}] \text{ in FA 1} = 0.001131 \times 1000/25 = 0.0452 \text{ mol dm}^{-3}$$

concentration of Na₂CO₃ in **FA 1** =

concentration of NaOH in **FA 1** =

[1]

- (d) The maximum error in a single burette reading is $\pm 0.05 \text{ cm}^3$.

When making up the diluted acid, **FA 3**, a student recorded that 35.00 cm^3 of **FA 2** was used. What are the smallest and largest possible volumes of acid that were run into the volumetric flask?

smallest volume used = 34.90 cm^3

largest volume used = 35.10 cm^3

[1]

- (e) A student suggested doing the titration in **(a)(ii)** differently – **FA 3** is placed in the conical flask and **FA 1** in the burette, using methyl orange indicator followed by thymolphthalein indicator.

Explain if this method will allow you to determine the concentrations of NaOH and Na_2CO_3 in **FA 1**.

As there is **excess HCl** in the conical flask, methyl orange only changes colour when **both** Na_2CO_3 and NaOH have completely reacted i.e. only **one end-point** will be obtained. Hence this method does **not** allow $[\text{Na}_2\text{CO}_3]$ and $[\text{NaOH}]$ to be determined.

.....
.....
.....[1]

[Total: 13]

2 Heat of reaction between copper(II) ions and iron metal

In this experiment, you will measure the heat given out by the reaction of excess iron with copper(II) sulfate solution and use this to find the concentration of the copper(II) sulfate.

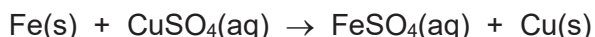

FA 4 is iron powder.

FA 5 is aqueous copper(II) sulfate, CuSO_4 .

In an appropriate format in the space below, prepare a table in which you may record each temperature and the time it was taken.

1. Wash thoroughly a burette and fill it with **FA 5**. Place a Styrofoam cup into a 250 cm³ beaker to prevent it from tipping over. Transfer 40.00 cm³ of **FA 5** into the Styrofoam cup.
2. Place the lid onto the cup and insert the thermometer through the lid. Measure and record the initial temperature of the **FA 5** solution in the cup.
3. Start the stopwatch. Measure and record the temperature of the solution in the cup **every half minute** up to and including the temperature at 1.5 min. Stir the solution using the thermometer.
4. At time $t = 2.0$ min, add all the powdered iron **FA 4** to the solution. Stir the mixture **thoroughly** with the thermometer to **ensure the solid mixes well with the solution**.
5. Record the temperature of the mixture **every minute** from $t = 2.5$ min. Continue stirring **thoroughly** and mixing the contents of the cup well **throughout** your recordings.
6. Once the temperature starts to drop, continue recording **every half minute** for a **further 3 minutes**. Constantly stir the solution **thoroughly**.

(a) Experimental Results

Time / min	Temperature / °C
0.0	29.6
0.5	29.6
1.0	29.6
1.5	29.6
2.0	–
2.5	29.8
3.5	32.4
4.5	35.8
5.5	38.6
6.5	40.6
7.5	41.8
8.5	42.5
9.5	42.6
10.5	42.3
11.0	42.2
11.5	42.0
12.0	41.8
12.5	41.7
13.0	41.6

Correct headers and units [1]
 All temperatures recorded to correct precision [1]
 Full set of results with **at least 6 more readings** once the temperature starts to drop [1]
 Accuracy (difference between teacher's and student's highest recorded T) [1]

Correct axes + labels + units + sensible scale + plotted points (inclusive of 5 °C) occupy at least half the graph grid in both x and y directions [1]
 Correct plotting [1]
 Correctly draws the two best-fit lines [1]

[4]

- (b) (i) Plot on the grid below, a graph of the temperature on the y-axis, against time, t , on the x-axis. The scale for the temperature axis must allow you to plot a point with temperature 5 °C greater than the maximum temperature you recorded.

Draw the following **best-fit** straight lines on the graph.

- a line through the points before addition of **FA 4**.
- a line through the points once temperature starts to drop.

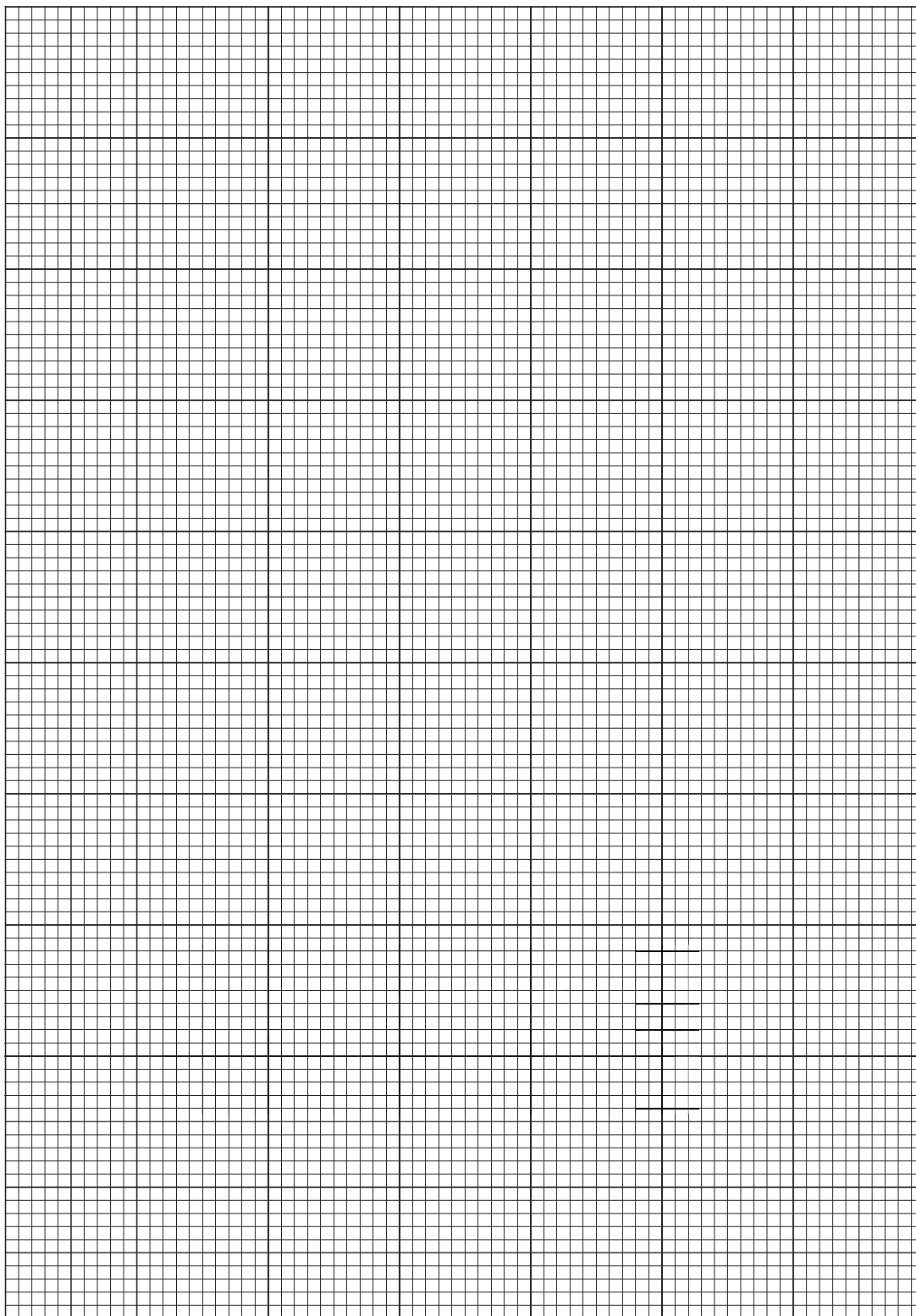

- (ii) Use the best-fit straight lines to determine the theoretical temperature change at time $t = 2.0$ min.

$$45.0 - 29.6 = 15.4 \text{ }^{\circ}\text{C}$$

Correctly determines theoretical T_{max} using graph [1]

Accuracy (difference between teacher's and student's change in T) [1]

change in temperature = [5]

- (c) (i) Use your answer to (b)(ii) to calculate the heat energy produced in the reaction. (Assume that **4.2 J** are required to increase the temperature of 1 cm^3 of solution by $1 \text{ }^{\circ}\text{C}$.)

$$q = 40.00 \times 4.2 \times 15.4 = 2587.2 = 2590 \text{ J}$$

heat energy produced = [1]

- (ii) The molar enthalpy change, ΔH , for the reaction shown below is -152 kJ mol^{-1} .

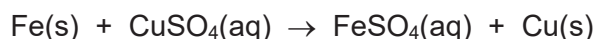

Use this value and your answer to (c)(i) to calculate the concentration of copper(II) sulfate, in mol dm^{-3} , in **FA 5**.

$$n\text{Cu}^{2+} \text{ in } 40.00 \text{ cm}^3 \text{ of FA 4} = 2587 / 152000 = 0.01702 \text{ mol} \quad [1]$$

$$[\text{Cu}^{2+}] \text{ in FA 4} = 0.01702 / (40.00/1000) = 0.426 \text{ mol dm}^{-3} \quad [1]$$

Shows working in **all** calculations in Q1 and Q2 [1]

Shows appropriate significant figures in **all** final answers [1]

Shows appropriate units in **all** answers [1]

concentration of copper(II) sulfate = [5]

- (d) (i) Calculate the maximum percentage error in the highest temperature that you recorded in your results table.

$$\text{maximum percentage error} = 0.1 / 42.6 \times 100 \% = 0.23 \%$$

maximum percentage error = [1]

- (ii) What would be the expected change in temperature obtained in (b)(ii) if the volume of copper(II) sulfate used was halved? Explain your answer.

Since CuSO_4 is the limiting reagent, using half the volume of CuSO_4 means only half the original amount of Cu^{2+} is reacted, hence only half the heat will be released. However, the volume of solution to be heated is also halved. Hence the change in temperature will be the same.

.....
[1]

[Total: 17]

3 Planning

The concentration of copper(II) sulfate in **FA 5** in Question 2 may be determined instead, by titration of the aqueous solution obtained after step 5, with aqueous potassium manganate(VII).

The reaction mixture obtained after step 5 in Question 2 contains $\text{FeSO}_4(\text{aq})$ and solids iron and copper. This mixture needs to be first filtered. The filtrate is then diluted to obtain a solution suitable for titration with aqueous potassium manganate(VII) of known concentration, in the presence of acid.

The manganate(VII) ions react with iron(II) ions as shown in the following equation.

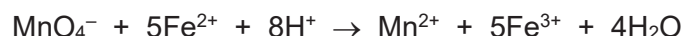

- (a) Using information from Question 2, determine a suitable concentration of aqueous potassium manganate(VII) to use in this titration. The concentration of manganate(VII) should not exceed $0.0500 \text{ mol dm}^{-3}$.

You are to assume that the concentration of copper(II) sulfate in **FA 5** is $0.800 \text{ mol dm}^{-3}$. (Note that this is not the correct value.)

Show clearly your calculations and any assumptions.

$$\begin{aligned} n(\text{Cu}^{2+}) \text{ in } 40.00 \text{ cm}^3 \text{ of FA 5} \\ = 0.800 \times 40/1000 = 0.032 \text{ mol} = n(\text{Fe}^{2+}) \text{ produced in mixture} \quad [1] \end{aligned}$$

Assume pipette 25 cm^3 (out of 40 cm^3) of Fe^{2+} and dilute to 250 cm^3 , then draw out 25 cm^3 for titration,

$$n(\text{Fe}^{2+}) \text{ used for titration} = 0.032 \times 25/40 \times 1/10 = 0.0020 \text{ mol}$$

$$n(\text{MnO}_4^-) \text{ needed for titration} = 0.0020 / 5 = 0.00040 \text{ mol} \quad [1]$$

$$\begin{aligned} \text{Assume titre to be } 25 \text{ cm}^3, \\ [\text{KMnO}_4] = 0.00040 / (25/1000) = 0.0160 \text{ mol dm}^{-3} \quad [1] \end{aligned}$$

[3]

- (b) Plan an experiment to determine the concentration of copper(II) sulfate in **FA 5** using the titration method described above.

In your plan, you should include details of:

- the quantities of chemicals you would use,
- the apparatus you would use and the procedure you would follow,
- the measurements you would take.

1. Filter the mixture into a dry conical flask, using dry filter funnel and dry filter paper.
2. Pipette 25.0 cm³ of the filtrate into a 250 cm³ volumetric flask. Top up to the mark with deionised water. Stopper and shake to ensure a homogeneous solution.
3. Fill a burette with 0.0160 mol dm⁻³ aqueous KMnO₄ solution. Record the initial burette reading.
4. Pipette 25.0 cm³ of the diluted solution into a conical flask.
5. Add 10 cm³ of 1.0 mol dm⁻³ H₂SO₄ solution into the conical flask.
6. Titrate the solution in the conical flask with KMnO₄ until the end-point where the solution turns from yellow to orange/pink. Record the final burette reading.
7. Repeat steps 4-6 until consistent results within +/-0.10 cm³ are obtained.

Filters reaction mixture into volumetric flask and ensure quantitative transfer of all Fe²⁺
 OR: Filters reaction mixture using dry filter funnel, dry filter paper and dry conical flask into beaker/conical flask and draws out suitable volume of filtrate using pipette for dilution

Proposes correct dilution steps and apparatus from Question 1

Proposes correct titration steps and apparatus from Question 1

Adds excess dilute H₂SO₄ into conical flask before titration

Gives correct colour change at end-point (yellow to orange/pink)

[1]

[1]

[1]

[1]

[1]

.....	
.....	
.....	
.....	
.....	[5]

[Total: 8]

4 Qualitative analysis

In this question you will perform a series of test-tube reactions and use the observations to help you deduce the identities of two solids present in a given mixture **FA 6**.

You will also **devise a plan**, consisting of test-tube reactions, and **carry out** the plan to distinguish between three solutions **FA 9**, **FA 10** and **FA 11**, so that each is identified.

At each stage of any test you are to record details of the following:

- details of colour changes and precipitates formed
- the names of gases evolved and details of the test used to identify each one

You should indicate clearly at what stage in a test a change occurs.

No additional tests for ions present should be attempted.

- (a) **FA 6** is a mixture of two solids: **FA 7**, which is soluble in water and **FA 8**, which is insoluble in water. Each contains one cation and one anion listed in the Qualitative Analysis Notes on pages 15 and 16.

Carry out the following tests and record your observations in the table.

<i>test</i>		<i>observations</i>
(i)	Place all of the solid, FA 6 , into a boiling tube. Add 10 cm ³ of deionised water and shake to dissolve FA 7 . Filter the mixture, collecting the filtrate in a test-tube. Keep the filtrate for tests (ii) to (iv). Wash the residue, FA 8 , with deionised water. Collect the washings in the previous boiling tube. Keep the residue for tests (v) to (vii).	colourless filtrate green residue
(ii)	To a 1 cm depth of filtrate, FA 7 , in a test-tube, add aqueous sodium hydroxide. Carefully warm the mixture.	no ppt no pungent/NH ₃ gas evolved
(iii)	To a 1 cm depth of filtrate, FA 7 , in a test-tube, add aqueous ammonia.	no ppt
(iv)	To a 1 cm depth of filtrate, FA 7 , in a test-tube, add 5 drops of aqueous silver nitrate, followed by aqueous ammonia.	white ppt white ppt soluble in NH ₃ (aq)

	<i>test</i>	<i>observations</i>
(v)	<p>Transfer half a spatula of the residue, FA 8, into a clean boiling tube. Using a measuring cylinder, measure out 10 cm³ of dilute nitric acid.</p> <p>Transfer the acid to the boiling tube in portions. Mix the contents of the boiling tube thoroughly. Filter if necessary.</p> <p>This solution is FA 12.</p>	<p>green residue dissolves to give blue solution</p> <p>effervescence, gas gives white ppt with limewater</p>
(vi)	To a 1 cm depth of FA 12 in a test-tube, add 1 cm depth aqueous edta.	blue solution turns dark blue
(vii)	<p>To a 1 cm depth of FA 12 in a test-tube, add 1 cm depth aqueous sodium hydroxide,</p> <p>followed by aqueous ammonia.</p> <p>Do not discard the remaining FA 12. Keep the solution for (b).</p>	<p>blue ppt</p> <p>blue ppt dissolves to give dark blue solution</p>

[4]

10 observations [4]

(viii) From the observations, identify the ions in **FA 7** and **FA 8**.**FA 7** contains the cation Ba^{2+}/Ca^{2+} and the anion Cl^- **FA 8** contains the cation Cu^{2+} and the anion CO_3^{2-}

[2]

(ix) Explain in terms of the chemistry involved, your observations in (a)(iv).

Cl^- reacts with $AgNO_3$ to form white ppt of **AgCl**. With $NH_3(aq)$, complex $[Ag(NH_3)_2]^+$ is formed. [1]

This reduces $[Ag^+]$ and shifts the equilibrium: $AgCl(s) \rightleftharpoons Ag^+(aq) + Cl^-(aq)$ to the right / ionic product becomes lower than K_{sp} , so **AgCl** solid dissolves. [1]

.....

..... [2]

(x) State the type of reaction that occurred in (a)(vi).

Ligand exchange

..... [1]

(b) Planning

FA 9, **FA 10** and **FA 11** each contains one of the following but not in that order:

hydrogen peroxide iron(II) sulfate potassium iodide

You are required to plan and **perform** a series of test-tube reactions using only **FA 9**, **FA 10**, **FA 11** and, **FA 12** from **(a)(v)**, to identify the three solutions, **FA 9** to **FA 11**.

You should commence your plan by adding **FA 12** to each of **FA 9**, **FA 10** and **FA 11**.

Each solution should be identified by at least one positive test. It is **not** sufficient to identify a solution simply by eliminating all the others.

You should aim to use the **minimum number** of reactions.

You may find it useful to consider the standard electrode potentials given below.

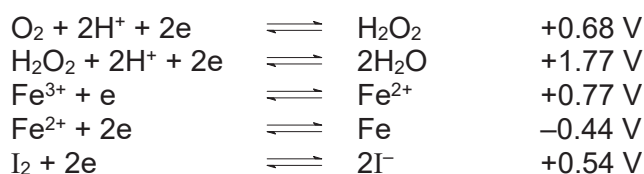

You may use the space below to plan your tests.

In the table in the next page, record

- details of the tests, including quantity of solutions used,
- observations of the tests,
- identities of the products that gave rise to the observations,
- identity of each solution.

.....

.....

.....

.....

.....

.....

.....

.....

.....

.....

.....

.....

.....

.....

.....

.....

.....

.....

.....

.....

.....

.....

.....

.....

.....

.....

.....

tests	observations, identities of products and identity of each solution		
	FA 9	FA 10	FA 11
1. To 1 cm depth FA solution, add 1 cm depth FA 12	no yellow/ orange/ brown solution formed	no yellow/ orange/ brown solution formed	cream ppt in brown solution cream ppt is CuI brown solution is I ₂ ∴ FA 11 is KI
2. To 1 cm depth FA solution, add 1 cm depth FA 11	no yellow/ orange/ brown solution formed	yellow solution formed, effervescence of gas which relights a glowing splint yellow solution is I ₂ gas is O ₂ ∴ FA 10 is H ₂ O ₂	
3. To 1 cm depth FA solution, add 1 cm depth FA 10	yellow solution formed, effervescence of gas which relights a glowing splint yellow solution is Fe ³⁺ gas is O ₂ ∴ FA 9 is FeSO ₄		

Correct sequence and quantities [1]

All negative tests observations correct [1]

5 positive observations, 5 products and 3 identities [6]

Conclusion

Solution **FA 9** contains

Solution **FA 10** contains

Solution **FA 11** contains

[8]

[Total: 17]

