



Established since 1930

RULANG PRIMARY SCHOOL

A Gallery of Scholars, A Vibrant Community of Wholesome Individuals

Name : _____ ()
Level : Primary One
Class : Primary 1 _____
Date : 8 May 2009
Setter : Ms Nooryanti Mohamed

SEMESTRAL REVIEW 1 MATHEMATICS

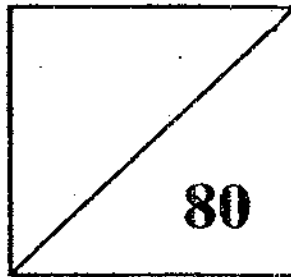

TOTAL TIME: 1 hour
35 questions
80 marks

- **DO NOT OPEN THIS BOOKLET UNTIL YOU ARE TOLD TO DO SO.**
- **READ ALL THE INSTRUCTIONS CAREFULLY.**
- **ANSWER ALL THE QUESTIONS.**

Section A (15 x 2 marks)

For each question, four options are given. One of these is the correct answer. Choose the correct answer and write its number (1, 2, 3 or 4) in the bracket provided.

1. How many pencils are there in the box below?

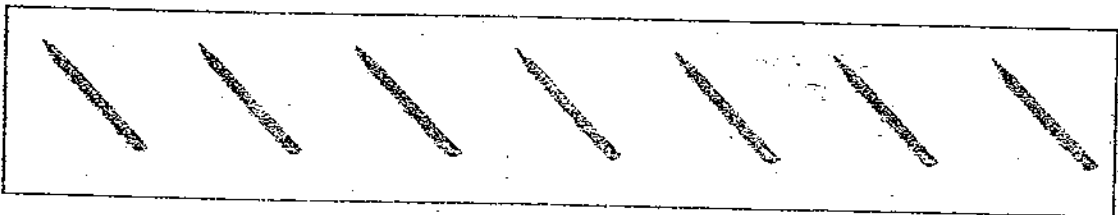

- (1) six (2) seven
(3) eight (4) nine ()

2.

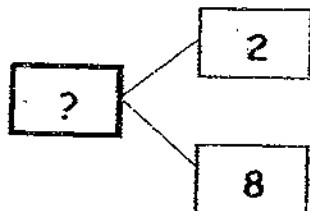

What is the missing number in the number bond above?

- (1) 10 (2) 9
(3) 3 (4) 6 ()

3. Who is 2nd from the right?



Ming Le



John



Ali



Raju

(1) Ming Le

(2) John

(3) Ali

(4) Raju

()

4. comes just after 14.

What is the missing number in the box above?

(1) 12

(2) 13

(3) 15

(4) 16

()

5. Which of the shapes below has no straight lines?

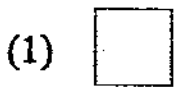

()

6. 2 less than 6 is .

What is the missing number in the box above?

(1) 8

(2) 2

(3) 5

(4) 4

()

7. What is the missing number in the box below?

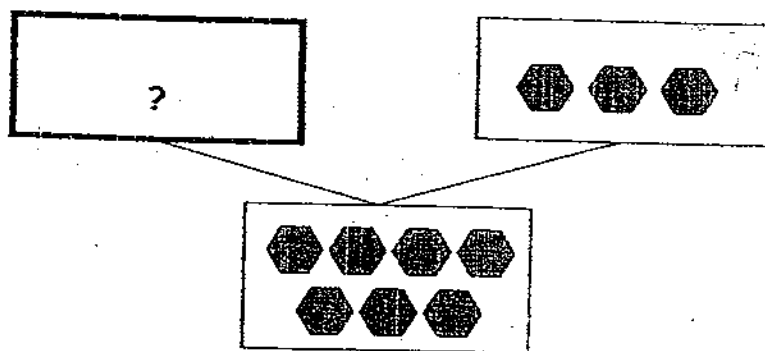

(1) 10

(2) 7

(3) 3

(4) 4

()

8.

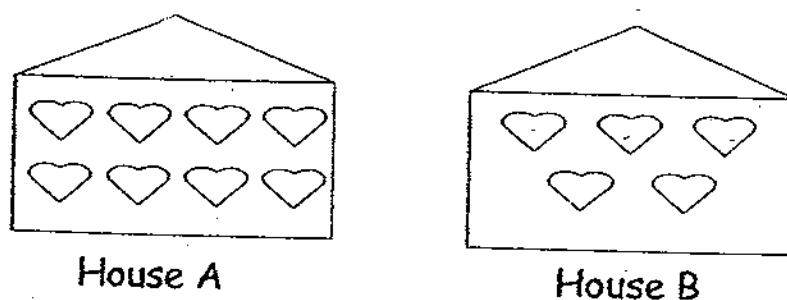

House A

House B

There are more shapes in House A than in House B.

(1) 8

(2) 2

(3) 3

(4) 5

()

9. What is the difference between 10 and 3?

(1) 6

(2) 7

(3) 8

(4) 13

()

10. Which number is greater than 13 but less than 18?

(1) 12

(2) 16

(3) 19

(4) 20

()

11. Which shape comes next?



(1) 

(2) 

(3) 

(4) 

()

12. What number should Krista put into the number machine below?

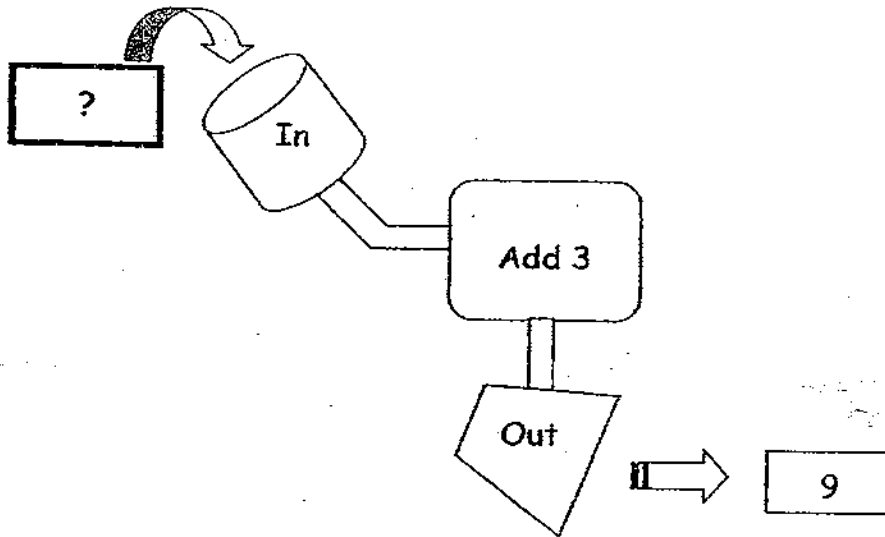

(1) 13

(2) 12

(3) 8

(4) 6

()

13. Sumei and Devi have 10 books altogether. If Sumei has 4 books, how many books does Devi have?

(1) 5

(2) 6

(3) 12

(4) 14

()

14. 4 more than 13 is .

What is the missing number in the box above?

(1) 17

(2) 12

(3) 10

(4) 9

()

15. How many circles are there in the picture below?

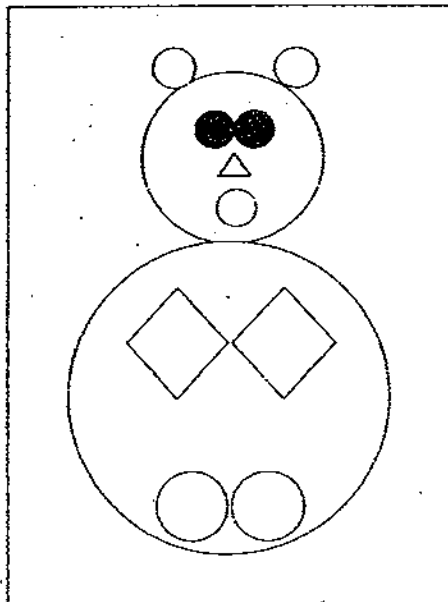

(1) 5

(2) 6

(3) 7

(4) 9

()

Section B (15 x 2 marks)

For each of the following questions, write the correct answer in the box provided.

16. What is the missing number in the box below?

4

5

17. How many sticks of ice-cream are there?
Write your answer in words.

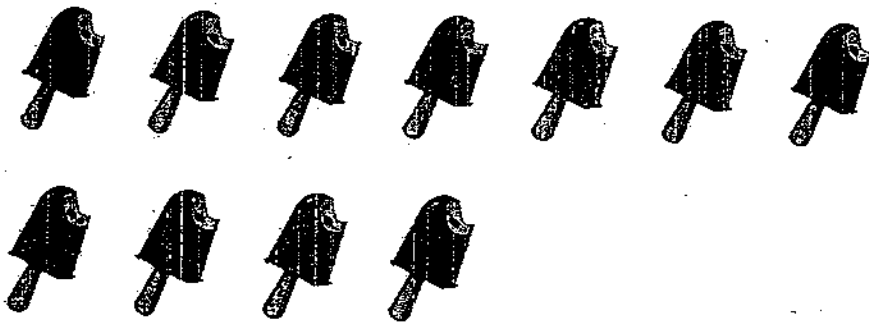

18. Circle the shape that does not belong to the group.

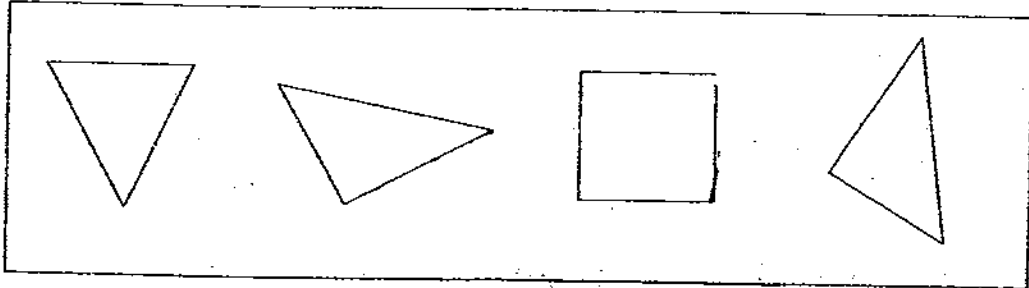

19. Look at the picture below.
How many more muffins are needed to make 8?



more muffins

20. Study the number bonds below.
What is the missing number?

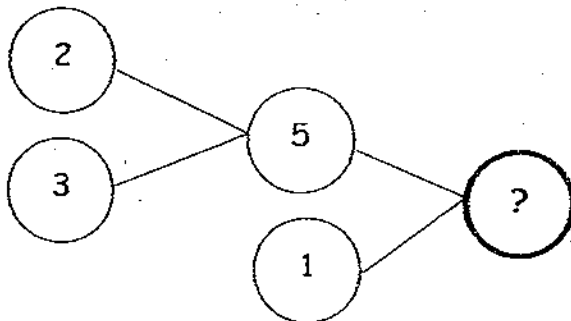

21. Circle the pair of numbers that makes 7.

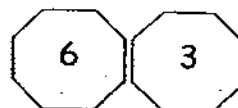
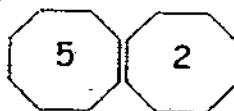
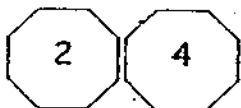
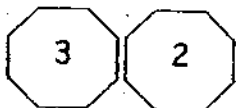

22. Circle the star that is between the 3rd and the 5th star.



23. How many fewer apples does Mindy have than Ben?

Mindy	
Ben	

fewer apples

24. Cross out the two shapes that have the same size.

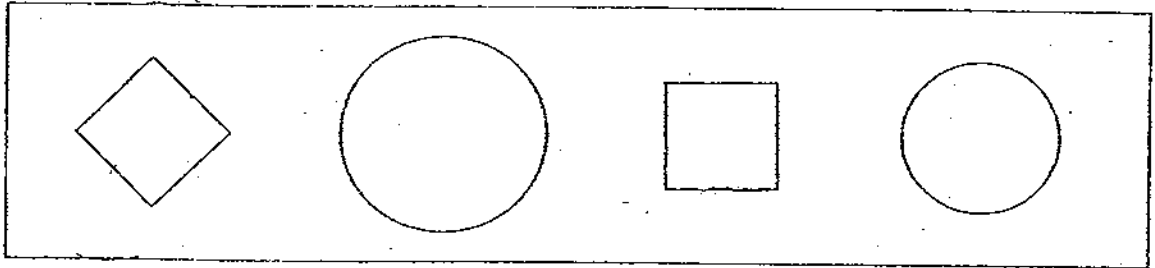

25. Add 2 to the sum of 3 and 4.
What is the answer?

An empty rectangular box for the answer.

26.

$$\diamond + \star = 6$$

$$\diamond - \star = 2$$

$$\diamond = \boxed{?}$$

What is the missing number in the box above?

An empty rectangular box for the answer.

27. What is the missing number in the circle below?

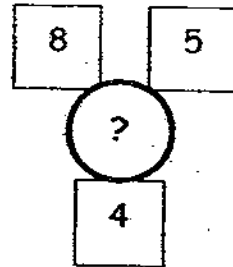
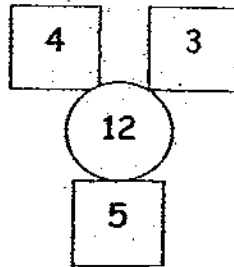
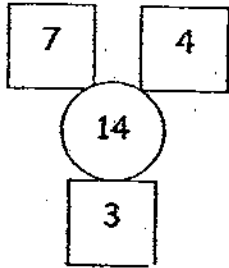

28. What is the missing number in the circle below?

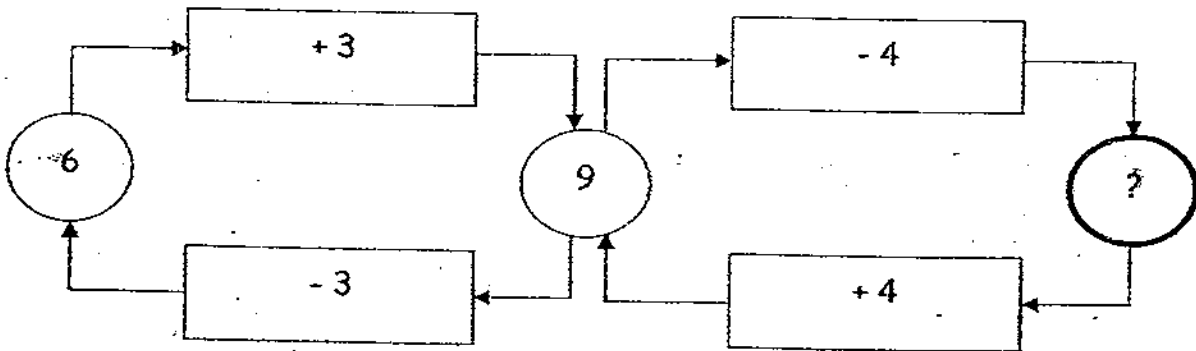

29. The picture below shows a strip of stars. A part of it is covered by a piece of paper. How many stars are covered?

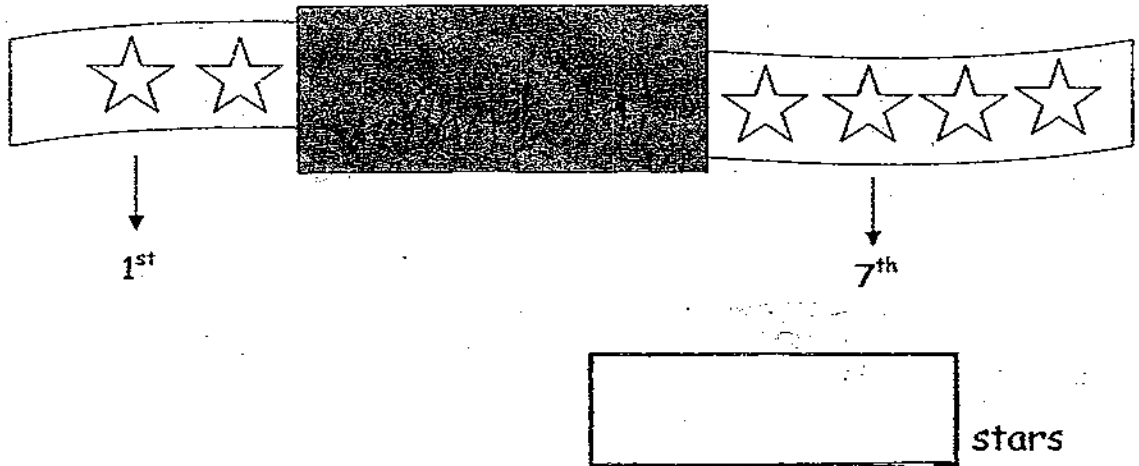

30. Draw 2 straight lines in the rectangle below to form 3 triangles. The triangles need not be of the same size.

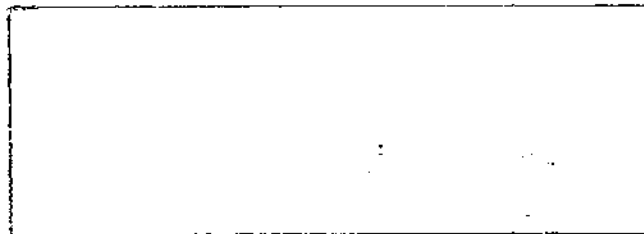

Section C (5 x 4 marks)

Answer each question in the space provided. Show your working clearly as marks will be awarded for relevant statements and correct answers.

31. Patrick has 3 red balloons. He also has 4 blue balloons.
How many balloons does Patrick have altogether?

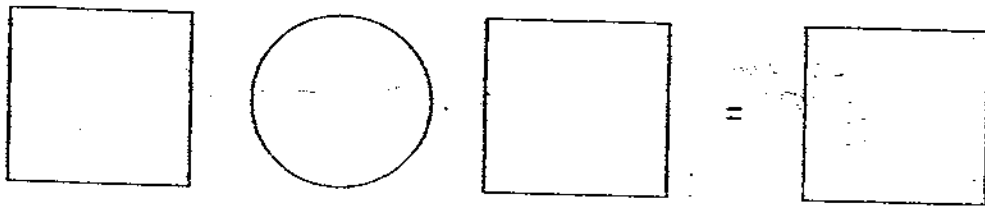

Patrick has _____ altogether.

32. Zaki bought 9 hamsters. He gave 4 hamsters away to his friend.
How many hamsters had he left?

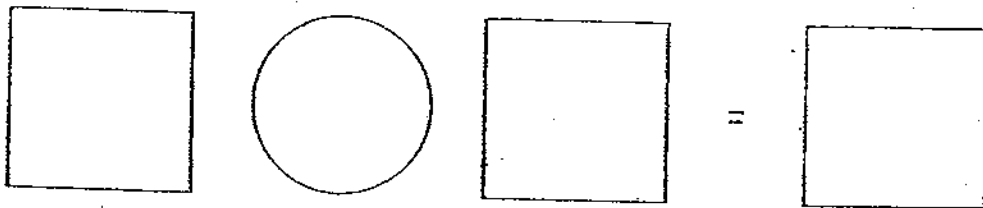

He had _____ left.

33. There are 16 apples and 9 oranges in a basket.
How many more apples than oranges are there?

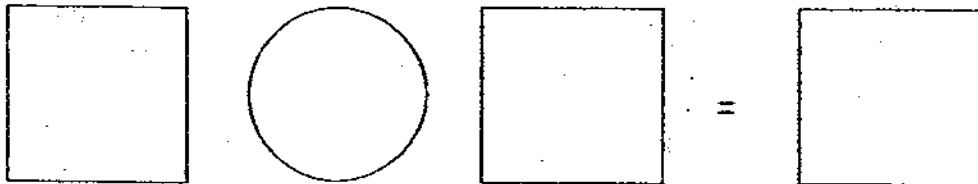

There are _____ than oranges.

34. Yun Xiang had some stickers. He gave 5 stickers to Anna and had 12 stickers left. How many stickers did Yun Xiang have at first?

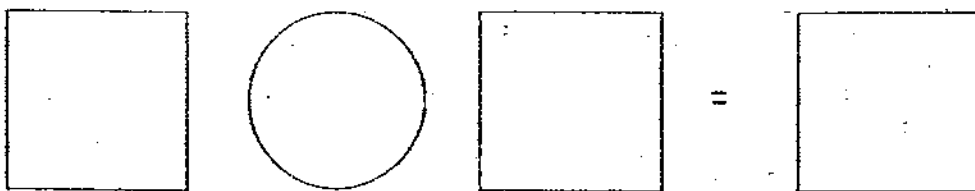

Yun Xiang had _____ at first.

35. Bobby is given four shapes as shown below. If he has to group any three shapes together, how many different groups will he get?

He will get _____

End-of-Paper



Always CHECK your work!

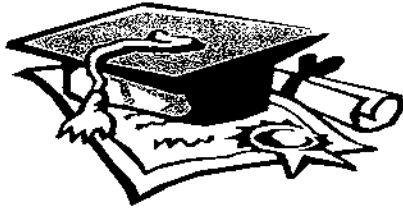

ANSWER SHEET

EXAM PAPER 2009

**SCHOOL : RULANG PRIMARY
SUBJECT : PRIMARY 1 MATHEMATICS**

TERM : SA1

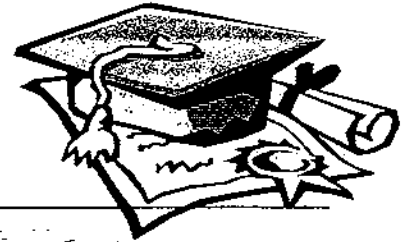

Q1	Q2	Q3	Q4	Q5	Q6	Q7	Q8	Q9	Q10	Q11	Q12	Q13	Q14	Q15	Q16
2	1	3	3	2	4	4	3	2	2	2	4	2	1	4	9

17)eleven 18) 19)3 more 20)6 21)5,2 22)☆☆☆○☆☆

23)3 24)   25)9 26)4 27)17 28)5 29)3star

30) 

31) $3+4=7$
Patrick has 7 balloons altogether.

32) $9-4=5$
He had 5 hamsters.

33) $16-9=7$
There are 7 more apples than orange.

34) $12+5=17$
Yun Xiang had 17 stickers at first.

35)He will get 9