



Rosyth School

Second Semestral Assessment 2014

Mathematics

Primary 3

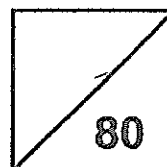

Name: _____

Class: Pr. 3 - _____ Register No.: _____

Duration: 1h 45 min

Date: 28 October 2014

Parent's Signature: _____

Instructions to Pupils:

1. Do not open this booklet until you are told to do so.
2. Follow all instructions carefully.
3. This paper consists of 3 parts, Sections A, B and C.
4. For questions 1 to 15 in Section A, shade the correct ovals on the Optical Answer Sheet (OAS).
5. ANSWER ALL THE QUESTIONS.

	Maximum	Marks Obtained
Section A	25	
Section B	35	
Section C	20	
Total	100	

This paper consists of 19 pages altogether, including the cover page.

This paper is not to be reproduced in part or whole without the permission of the Principal.

Section A (25 marks)

For questions 1 to 15, four options are given. One of them is the correct answer. Make your choice (1, 2, 3 or 4). Shade the correct ovals (1, 2, 3 or 4) onto the Optical Answer Sheet provided. Questions 1 to 5 carries 1 mark each. Questions 6 to 15 carries 2 marks each.

1. In 6 841, the digit 4 is in the _____ place.

- (1) ones
- (2) tens
- (3) hundreds
- (4) thousands

2. $6 \times 3 = 9 \times \square$

- (1) 1
- (2) 2
- (3) 9
- (4) 18

3. What is the volume of water in the measuring cylinder?

- (1) 50 ml
- (2) 225 ml
- (3) 250 ml
- (4) 350 ml

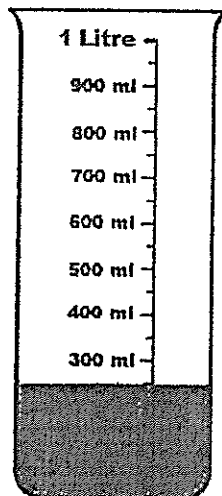

4. \$4.35 is _____ more than \$2.95.
- (1) \$1.40
 - (2) \$2.60
 - (3) \$6.25
 - (4) \$7.30
5. Express 3 thousands and 12 tens in numerals.
- (1) 312
 - (2) 3 012
 - (3) 3 102
 - (4) 3 120
6. Subtract 39 tens from 62 hundreds. The answer is _____.
- (1) 23
 - (2) 230
 - (3) 5 810
 - (4) 6 161
7. Form the largest 4-digit even number using the following digits.

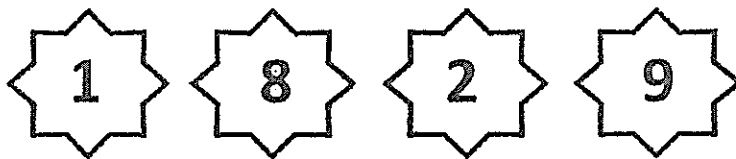

- (1) 8 912
- (2) 9 218
- (3) 9 812
- (4) 9 821

8. What must be added to 1 500 to make 3 200?
- (1) 700
 - (2) 1 700
 - (3) 2 700
 - (4) 4 700
9. What is the product of 534 and 6?
- (1) 89
 - (2) 540
 - (3) 3 084
 - (4) 3 204
10. What is the remainder when 763 is divided by 3?
- (1) 1
 - (2) 2
 - (3) 3
 - (4) 0
11. The height of a Primary 3 pupil is about _____.
- (1) 13 cm
 - (2) 13 m
 - (3) 130 cm
 - (4) 130 m

12. Which one of the following fractions has the smallest value?

(1) $\frac{3}{5}$

(2) $\frac{1}{2}$

(3) $\frac{2}{7}$

(4) $\frac{3}{4}$

13. What fraction of the figure is NOT shaded?

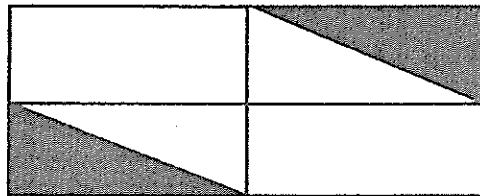

(1) $\frac{1}{4}$

(2) $\frac{2}{6}$

(3) $\frac{3}{4}$

(4) $\frac{4}{6}$

14. Jensen collected 138 seashells from the beach. He collected 6 times as many seashells as Farah. How many seashells did Farah collect from the beach?

(1) 23

(2) 132

(3) 144

(4) 828

15. The figure below is made up of identical 2-cm squares. Find the area of the figure.

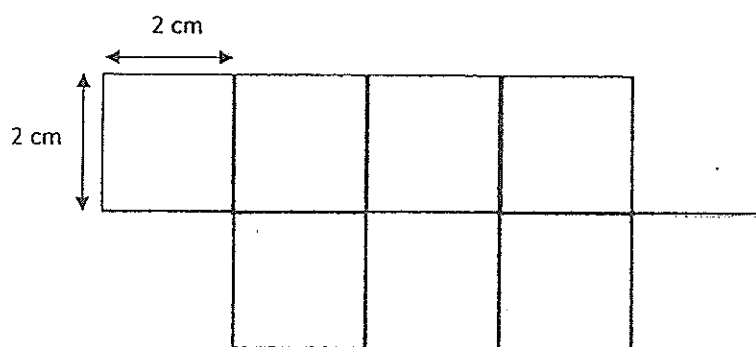

- (1) 7 cm²
- (2) 14 cm²
- (3) 28 cm²
- (4) 32 cm²

Section B (20 marks)

For questions 16 to 35, show your working clearly in the space below each question and write your answer in the answer spaces provided. Give your answers in the units stated. Questions 16 to 20 carries 1 mark each. Questions 21 to 35 carries 2 marks each.

16. Find the difference between 9 483 and 3 456.

Answer: _____

17. There are _____ twenty-cent coins in \$5.

Answer: _____

18. What is the mass of the chicken? Express your answer in grams.

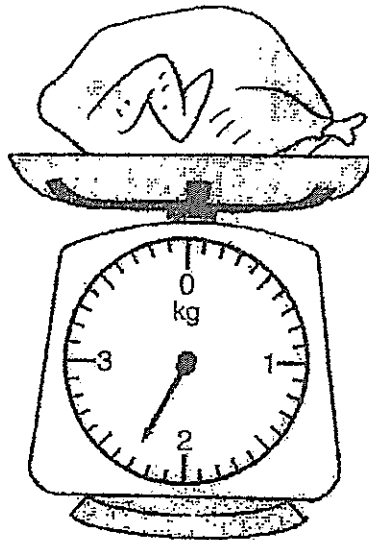

Answer: _____ g

19. Look at the number pattern below and find the missing number in the box.

$$\boxed{3\ 780}, \quad \boxed{3\ 980}, \quad \boxed{?}, \quad \boxed{4\ 380}, \quad \boxed{4\ 580}$$

Answer: _____

20. Convert 6 014g to kilograms and grams.

Answer: _____ kg, _____ g

21. Find the value of A and B.

$$\begin{array}{r} 6\ 9\ \boxed{B}\ 8 \\ -\ 4\ 2\ 1\ 5 \\ \hline 2\ 6\ 9\ \boxed{A} \end{array}$$

Answer: A = _____

Answer: B = _____

26. A cake was cut into 12 equal slices.
Amos ate $\frac{1}{4}$ of it and Siti ate $\frac{1}{12}$ of it.
How many slices of the cake did they eat?

Answer: _____

27. Andy spent $\frac{1}{5}$ of his savings on a book and $\frac{3}{10}$ of it on some stationery.

What fraction of his savings was left?

Leave your answer in the simplest form.

Answer: _____

28. The square below is made up of 5 identical rectangles.

What is the area of the square if the breadth of each rectangle is 2 cm?

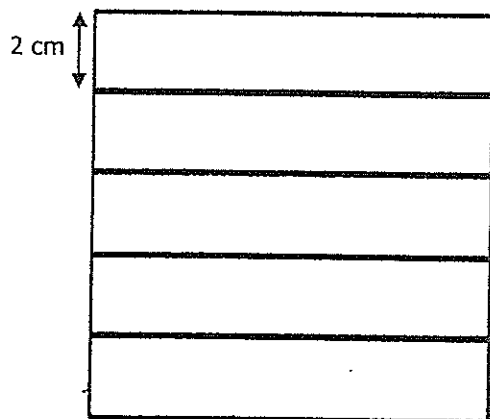

Answer: _____ cm²

29. The figure below is made up of a rectangle and a square.

What is the perimeter of the figure?

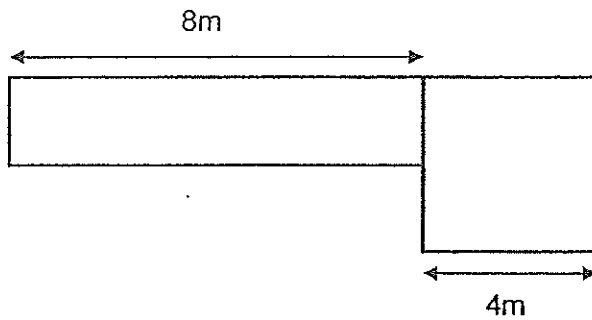

Answer: _____ m

30. Look at the following word carefully and answer the following questions.

SMILE

- List all the letters which have parallel lines.
- List all the letters which have only one pair of perpendicular lines.

Answer: a) _____

b) _____

31. a) How many pairs of parallel lines are there in the figure below?

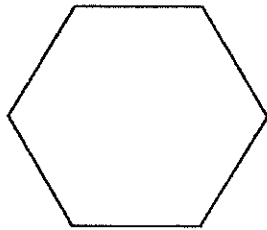

Answer: _____

- b) Name the pair of perpendicular lines in this figure.

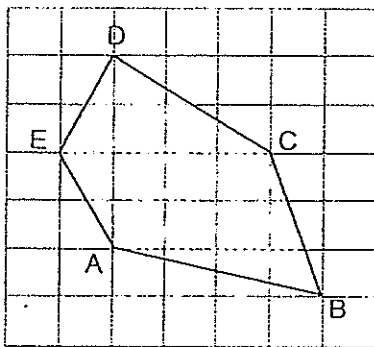

Answer: _____

32. a) The shape below has 8 angles. How many of these angles are bigger than a right angle?

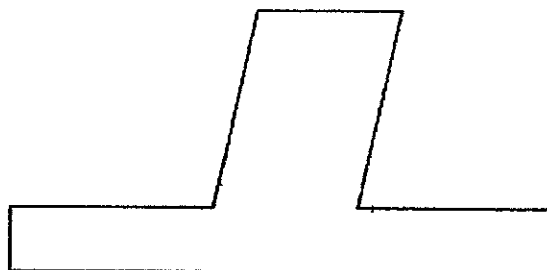

Answer: _____

- b) The shape below has 6 angles. How many of these angles are smaller than a right angle?



Answer: _____

33. How many right angles can you find in the following diagram?

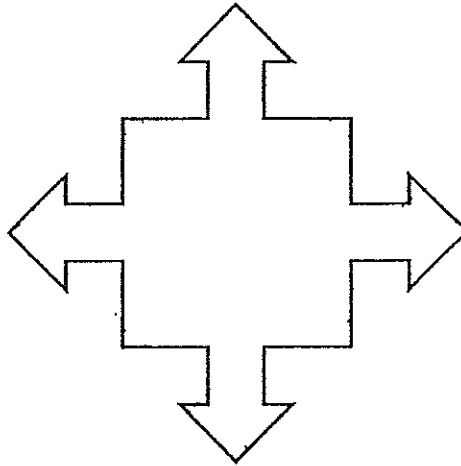

Answer: _____

Study the graph below carefully and answer questions 34 and 35.

The bar graph shows the number of stickers each pupil has.

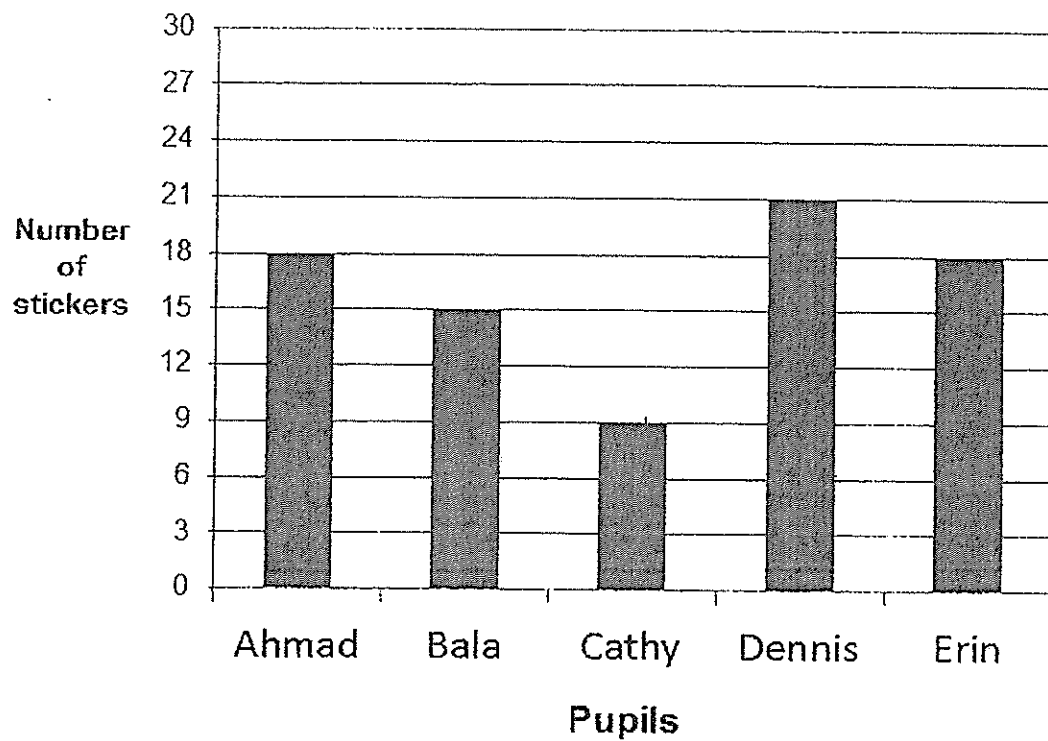

34. What is the total number of stickers the pupils have?

Answer: _____

35. Which pupil has half the number of stickers that Erin has?

Answer: _____

Section C (20 marks)

For questions 36 to 40, show your working and statements clearly in the space below each question and write your answers in the blanks provided. Each question carries 4 marks each.

36. The total cost of a handbag and a wallet is \$980.

The handbag costs 4 times as much as the wallet.

Find the cost of the handbag.

Answer: _____ (4m)

37. Mrs Tang had some oranges in her fruit stall.
She sold 538 of them and bought another 380 oranges.
In the end, she was left with 453 oranges.
How many oranges did she have in her fruit stall at first?

Answer: _____ (4m)

38. Rachel, Susan and Tracy shared a total of 225 hairclips.

Tracy has 3 times as many hairclips as Susan.

Susan has twice as many hairclips as Rachel.

How many hairclips does Susan have?

Answer: _____ (4m)

39. James arranged 14 flag poles at an equal distance from one another, in a straight line. The distance between the 1st pole and 4th pole is 12 m.
What is the distance from the 1st pole to the last pole?

Answer: _____ (4m)

40. The figure below is made up of a rectangle and a square.

a) What is the perimeter of the figure?

b) What is the area of the figure?

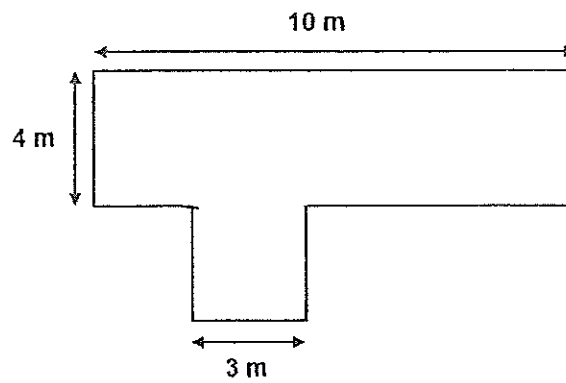

Answer: a) _____ (2m)

b) _____ (2m)

End of Paper



EXAM PAPER 2014

LEVEL : PRIMARY 3
SCHOOL : ROSYTH SCHOOL
SUBJECT : MATHS
TERM : SA2

Section A

Q1	Q2	Q3	Q4	Q5	Q6	Q7	Q8	Q9	Q10	Q11	Q12	Q13	Q14	Q15
2	2	3	1	4	3	3	2	4	1	3	3	3	1	3

Section B

- Q16 6027
Q17 25 twenty-cent coins
Q18 2300g
Q19 4180
Q20 6kg 14g
Q21 $A = 3, B = 0$
Q22 1283
Q23 $\frac{5}{6}, \frac{1}{2}, \frac{5}{12}$
Q24 $\frac{5}{9}$
Q25 114 sweets
Q26 4 slices
Q27 $\frac{1}{2}$
Q28 100cm^2
Q29 32m
Q30 (a) E, M
(b) L
Q31 3 pairs
Q32 (a) $ED \perp DC$
(b) 3
Q33 8
Q34 81
Q35 Cathy



Section C

Q36 $\$980 \div 5 = \196
 $\$196 \times 4 = \mathbf{\$784}$

Q37 $453 + 538 = 991$
 $991 - 380 = \mathbf{611}$

Q38 $225 \div 9 = 25$
 $25 \times 2 = \mathbf{50}$

Q39 $4 - 1 = 3$
 $12m \div 3 = 4m$
 $14 - 1 = 13$
 $13 \times 4m = \mathbf{52m}$

Q40 (a) Perimeter = $(10 + 10 + 4 + 4 + 3 + 3)m = \mathbf{34m}$
(b) $10m \times 4m = 40m^2$
 $3m \times 3m = 9m^2$
 $40m^2 + 9m^2 = \mathbf{49m^2}$

