

ANGLO-CHINESE SCHOOL
(JUNIOR)

SEMESTRAL ASSESSMENT 2 (2006)
PRIMARY 3

SCIENCE
BOOKLET A

Thursday 2nd November 2006

1 hour 30 minutes

Name : _____ ()

Class : P 3 _____

INSTRUCTIONS TO PUPILS

DO NOT TURN OVER THE PAGES UNTIL YOU ARE TOLD TO DO SO

Follow all instructions carefully.
There are 20 questions in this booklet.
Answer ALL questions.

INFORMATION FOR PUPILS

The total marks for this booklet is 40.
The total time for Booklets A and B is 1 hour 30 minutes.
This question paper consists of 13 printed pages. (Inclusive of cover page)

Section A (40 marks)

For each question from 1 to 20, four options are given. One of them is the correct answer. Choose the correct option (1, 2, 3 or 4) and shade the correct oval on the Optical Answer Sheet (OAS).

- 1 The diagram shows the human skeleton.

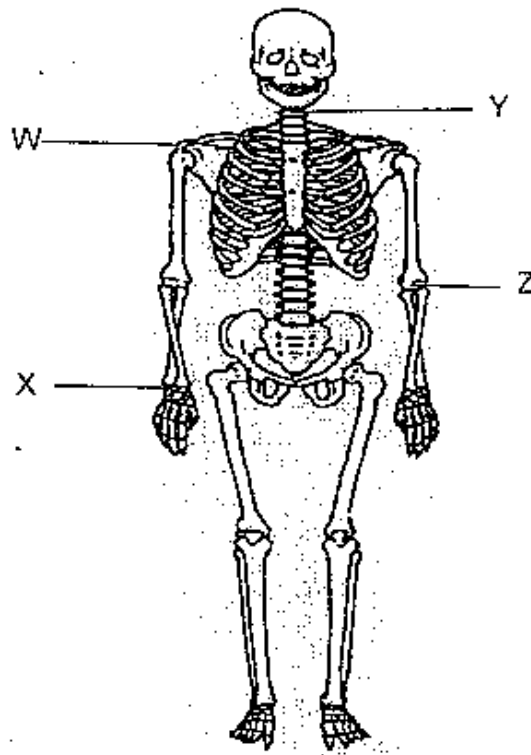

Which part of the skeleton has a joint which allows movements in only one direction?

- (1) W
- (2) X
- (3) Y
- (4) Z

- 2 Study the classification diagram below. Which one of the following headings for Group A and Group B is correct?

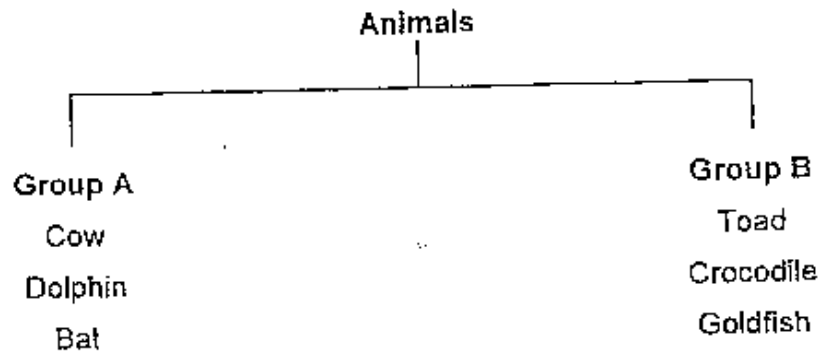

	Group A	Group B
(1)	Mammals	Reptiles
(2)	Land animals	Sea animals
(3)	Animals that give birth to young	Animals that lay eggs
(4)	Animals that eat plants only	Animals that eat plants and animals

3 Which of the objects below are made from things which were once alive?



A
Wooden
spoon



B
Paper
flowers



C
Glass
jar



D
Car
tyre

- (1) A and B only
- (2) B and D only
- (3) A, B and C only
- (4) A, B and D only

4 The diagram shows the life cycle of a beetle. It does not feed at the _____ stage.

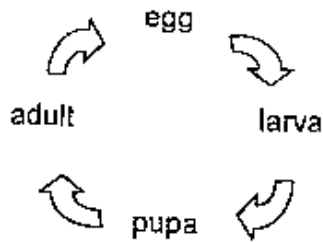

- (1) larva
- (2) pupa
- (3) egg and adult
- (4) larva and adult

- 5 Matthew did a study on two animals, X and Y. He drew a checklist and placed a tick (✓) in the box when he made the observation. The completed checklist is shown below.

Observation	Animal X	Animal Y
It has six legs	✓	✓
The young looks like the adult	✓	
There are 4 stages in the life cycle		✓

Which of the following animals could be Animal X and Animal Y?

	Animal X	Animal Y
(1)	cockroach	frog
(2)	grasshopper	cockroach
(3)	frog	butterfly
(4)	grasshopper	butterfly

- 6 The diagrams show the different stages in the life cycle of a bean plant. Which of the following gives the correct order of the life cycle?

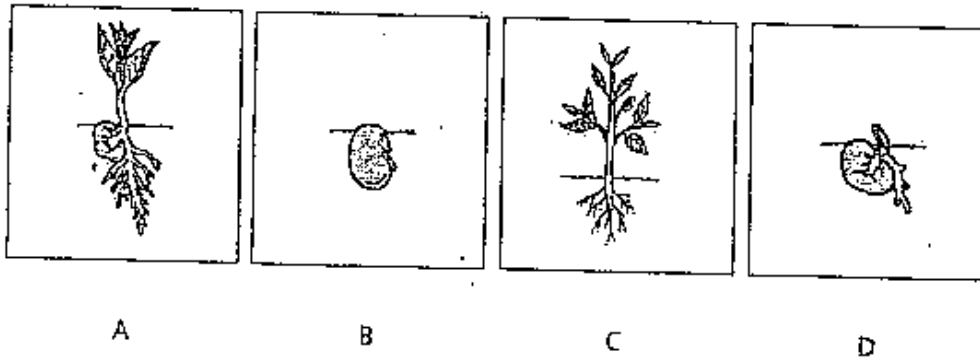

- (1) BCAD
- (2) BDAC
- (3) CBAD
- (4) CADB

- 7 Timothy placed a seed in a pot of soil and left them in a dark cupboard.

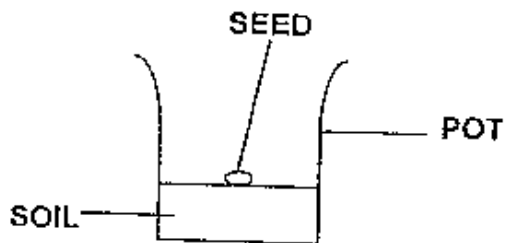

What must he do to enable the seed to grow into a young plant?

- (1) Add water to the soil.
- (2) Add fertiliser to the soil.
- (3) Place the pot next to the window.
- (4) Place a lamp inside the cupboard.

8 The diagrams show Wendy and her parents.



Father



Mother



Wendy

What characteristic did Wendy inherit from her mother?

- (1) long hair
- (2) short hair
- (3) big eyes
- (4) small eyes

9 What happens to muscles A and B when the arm is bent as shown below?

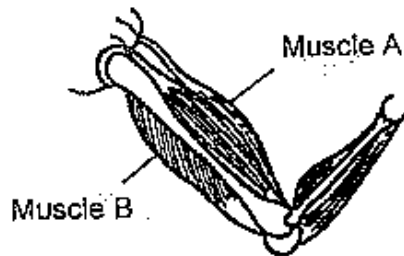

	Muscle A	Muscle B
(1)	relax	relax
(2)	contract	contract
(3)	relax	contract
(4)	contract	relax

- 10 The diagram shows a green plant.

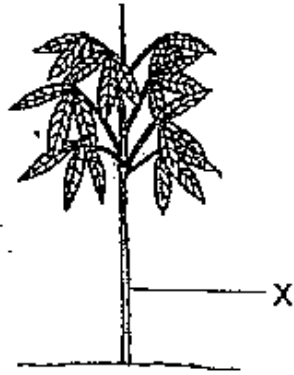

Which of the following is a function of part X?

- (1) Absorbs water.
- (2) Takes in mineral salts.
- (3) Supports the branches and leaves.
- (4) Holds the plant firmly in the ground.

- 11 Which of the following sense organs would you use to find out whether food has turned bad?

- A ears
- B eyes
- C nose
- D tongue

- (1) A and C only
- (2) B and D only
- (3) B, C and D only
- (4) A, B, C and D

12 The _____ system of the human body works together with the digestive system by carrying the digested food to the different parts of the body.

- (1) skeletal
- (2) muscular
- (3) circulatory
- (4) respiratory

13 The diagram shows the digestive system of the human body.

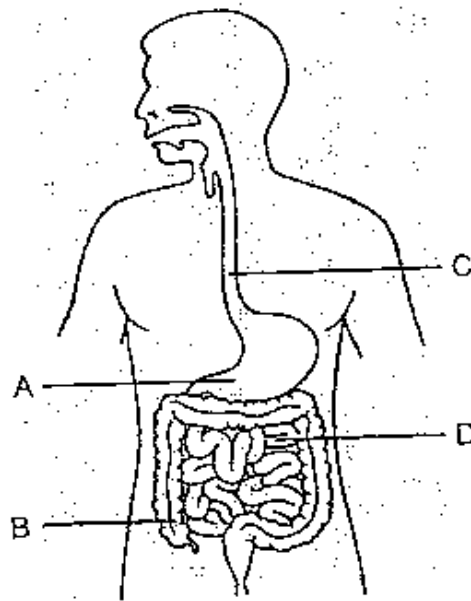

Which part removes water from the food?

- (1) A
- (2) B
- (3) C
- (4) D

- 14 The table below shows the strength of a magnet at different parts. Which parts of the magnet are the poles?

Part of Magnet	Number of pins attracted
P	10
Q	2
R	9
S	4



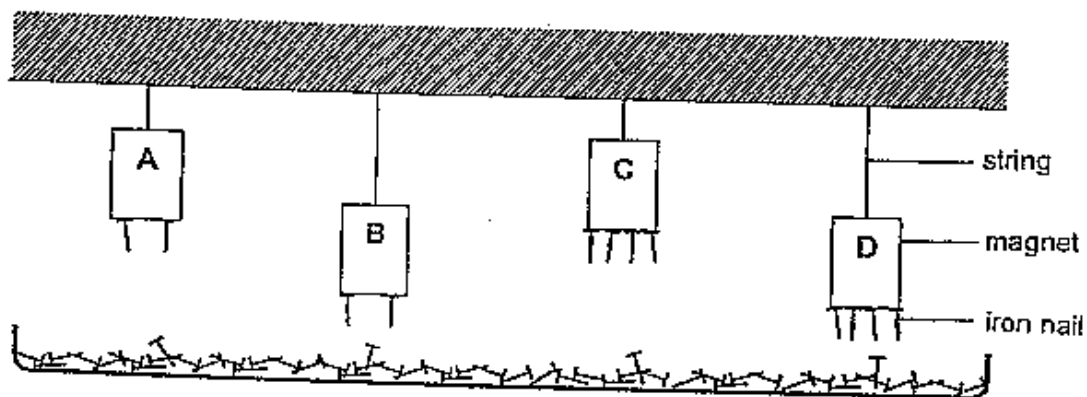



- (1) P and Q
 (2) P and R
 (3) Q and S
 (4) R and S
- 15 John hung 4 different magnets (A, B, C and D) above a tray of iron nails. The magnets were hung at different distances above the tray. The diagram shows the number of iron nails that were attracted by each magnet.

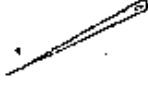

Which of the magnets has the strongest magnetic strength?

- (1) A
 (2) B
 (3) C
 (4) D

16 Which of these objects would not be attracted by a magnet?

A  needle	B  plastic ruler	C  eraser
D  copper coin	E  safety pin	F  gold necklace

- (1) A and E only
- (2) D and E only
- (3) B, C, D and F only
- (4) A, B, C, D, E and F

17 The diagram shows a machine at a metal scrap yard.



The electromagnet is used to separate _____.

- (1) iron from steel
- (2) nickel from iron
- (3) steel from aluminium
- (4) aluminium from copper

- 18 Jack wants to magnetise a rod using the touch method.
Which one of the diagrams shows the correct method?

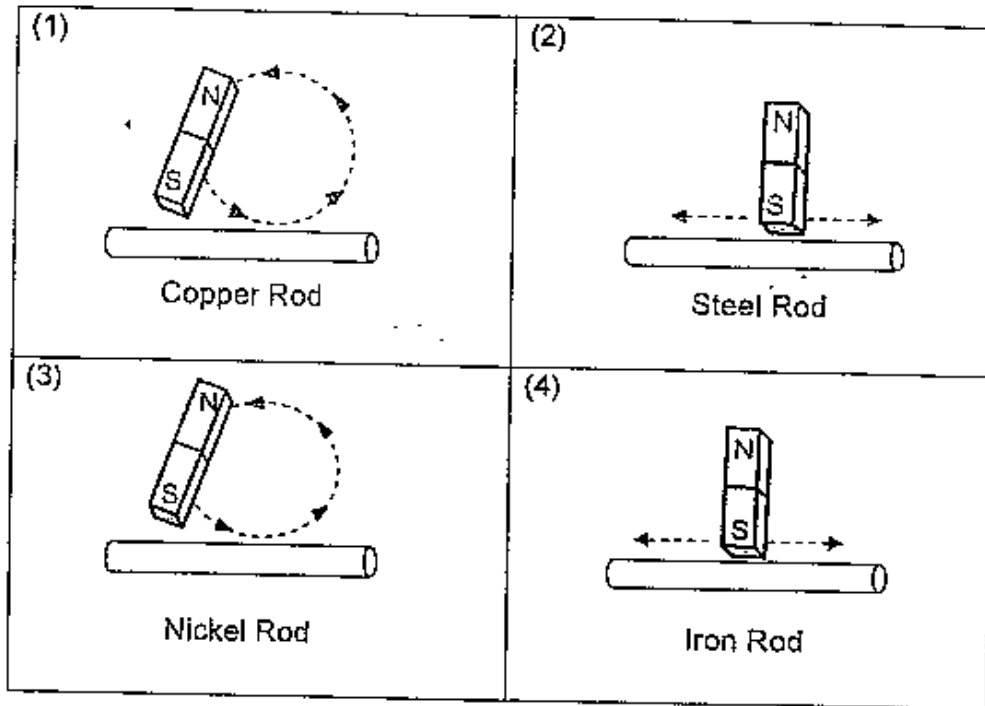

- 19 We can use magnets to _____.

- A separate iron filings from sand
- B hold a piece of paper onto a magnetic board
- C keep the door of a refrigerator tightly closed

- (1) A only
- (2) C only
- (3) B and C only
- (4) A, B and C

20 Cockroach A died first before Cockroach B. What is the most likely reason?

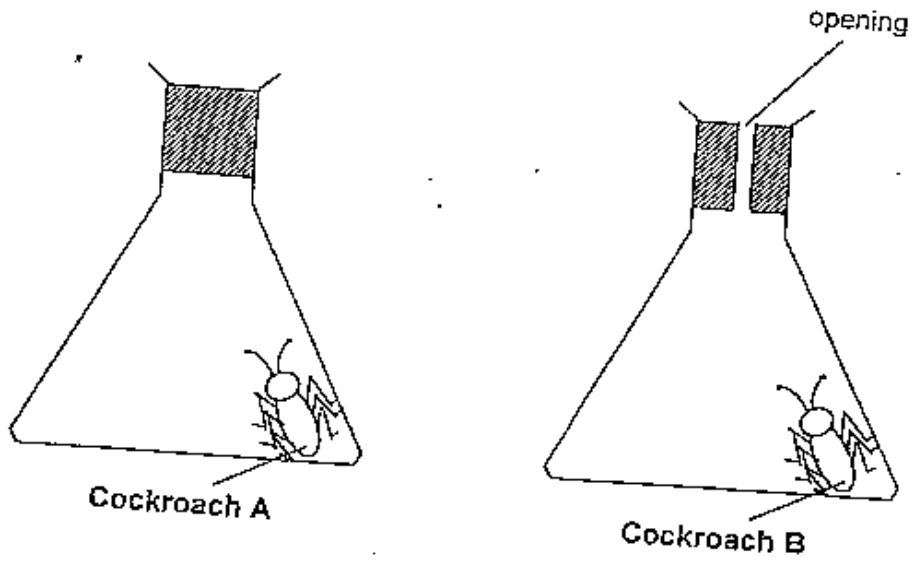

- (1) It did not have sunlight.
- (2) It did not have enough air.
- (3) It did not have enough food.
- (4) It did not have food and water.

Section B (50 marks)

Write your answers to questions 21 to 38 in this booklet.
Fill in the blanks with the correct answers.

21 Jane placed four lizards in separate bottles, each having different living conditions.

(A)

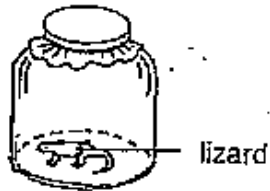

(B)



(C)

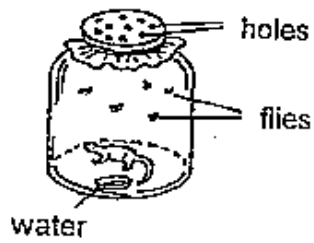

(D)

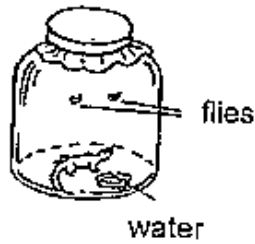

(a) In which of the bottles (A, B, C or D) would the lizard most likely be alive after 7 days? [1]

(b) Explain your answer in (a). [1]

- 22 The diagram shows a classification chart for animals according to their body covering.
 (a) Classify the animals according to their body coverings. [2]

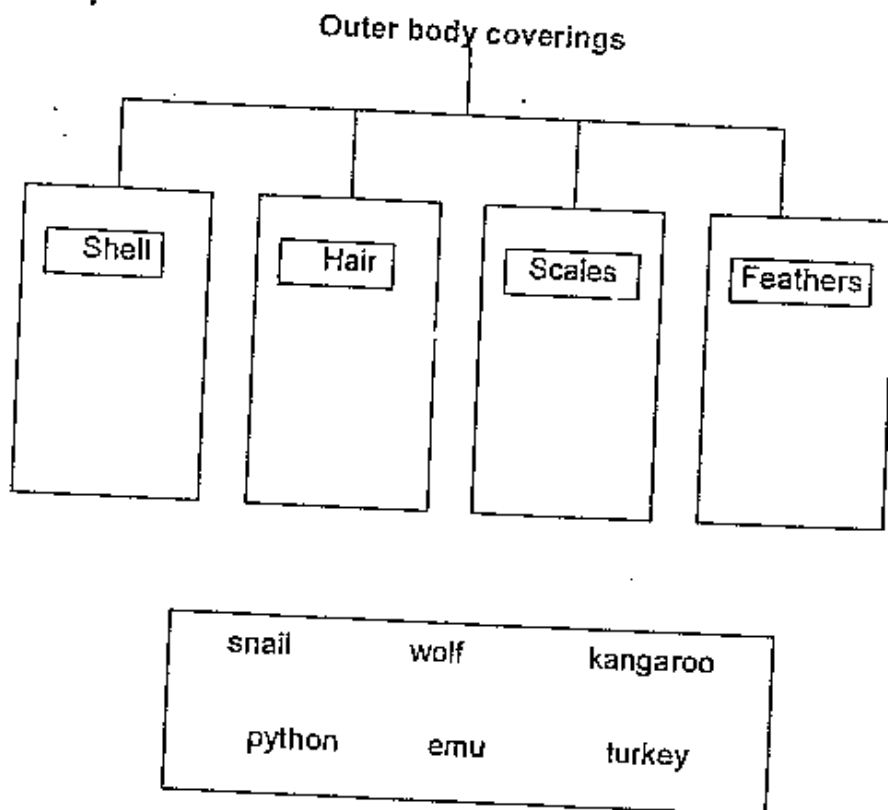

- (b) Can an earthworm be placed in the classification chart? Why? [1]

23 This is a flowchart for sorting objects into four boxes A, B, C and D. Study it carefully.

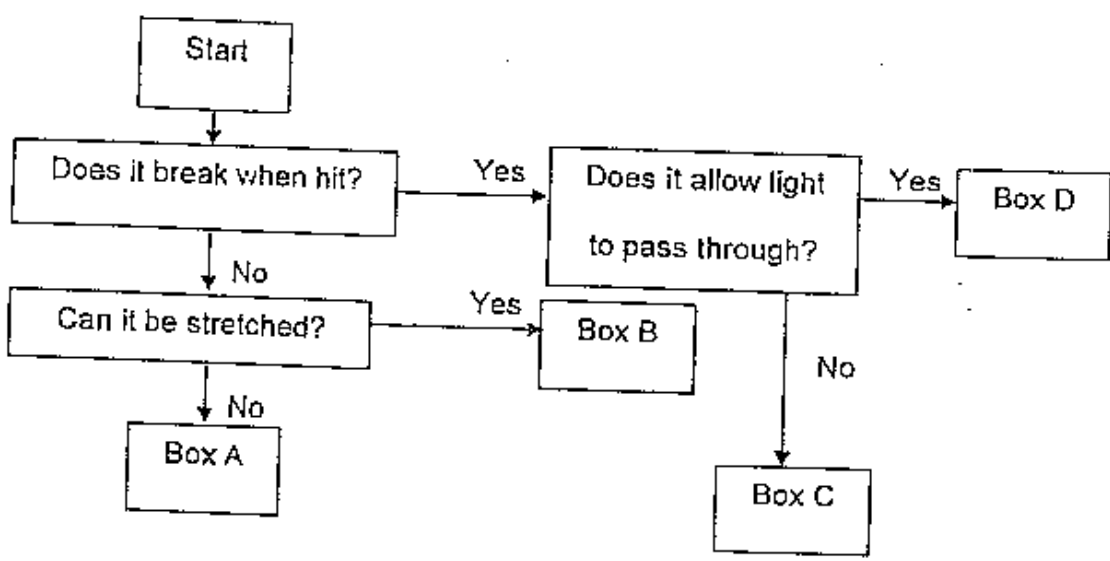

Joe has the following objects:

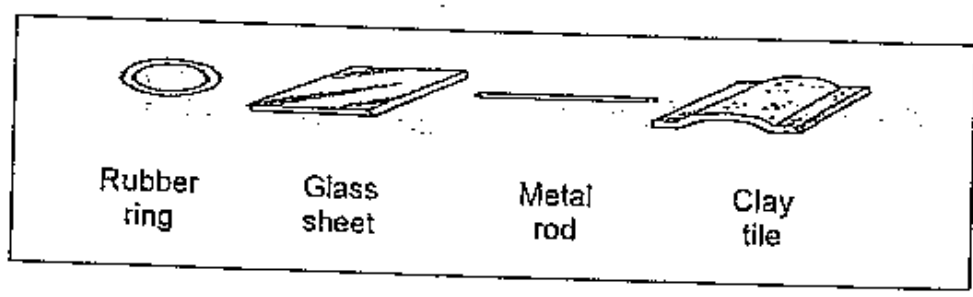

Complete the table by sorting out the objects into the correct boxes.

[4]

Box	Object
A	
B	
C	
D	

24 Fill in the blanks with a suitable word.

[3]

Many plants have seeds which can grow into seedlings. When the conditions are right, a seed can _____ or start to grow. First the root grows, then the _____ appears. In the beginning the seedling gets its food from the seed. When _____ develop, the seedling starts making its own food. It grows to become an adult plant.

25 The diagram shows the life cycle of a cockroach.

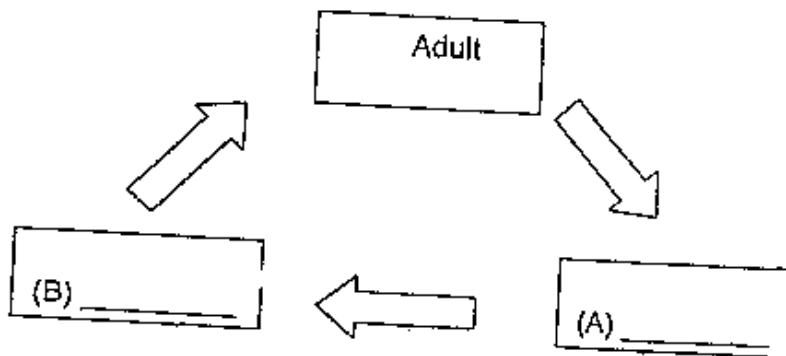

(a) Fill in the stages represented by (A) and (B) in the diagram.

[2]

(b) At which stage does the cockroach have wings?

[1]

26 The diagrams show the life cycles of two animals.

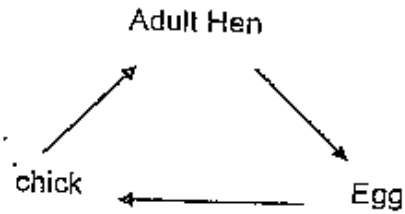
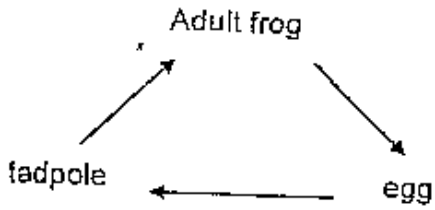

List one similarity and one difference between the two life cycles.

[2]

(a) Similarity:

(b) Difference:

(c) Name an aquatic animal that gives birth to young and also provides it with milk.

[1]

69

--

27 A family tree can be represented as follows:

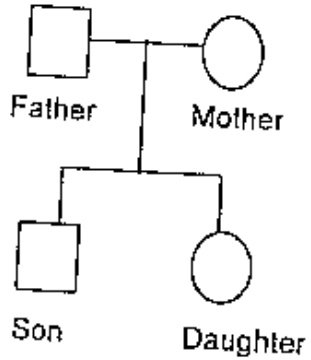

The diagram below shows a family tree.

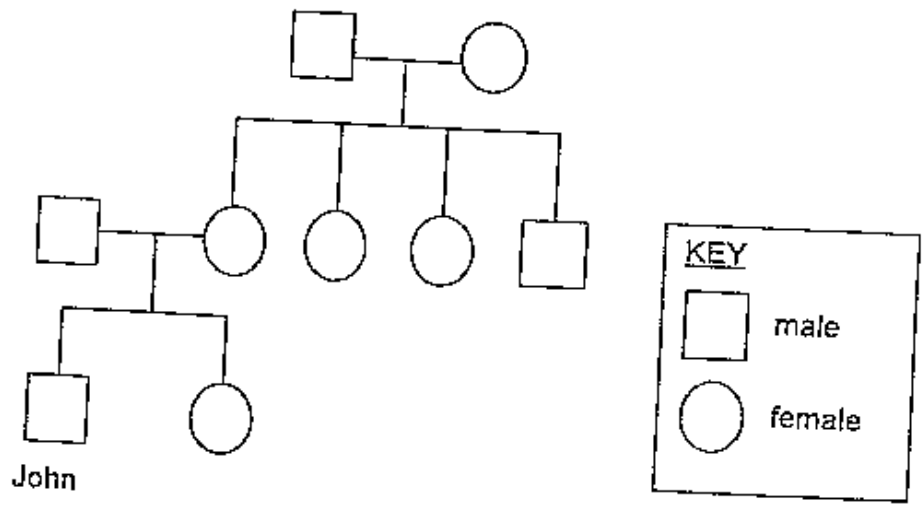

- (a) How many brothers does John have? [1]

- (b) How many aunts does John have? [1]

- (c) Shade the part of the diagram which represents John's grandfather. [1]

28 Tiny tubes A and B are found in the stem of a plant. The arrows in the diagram represents the movement of substances in the plant.

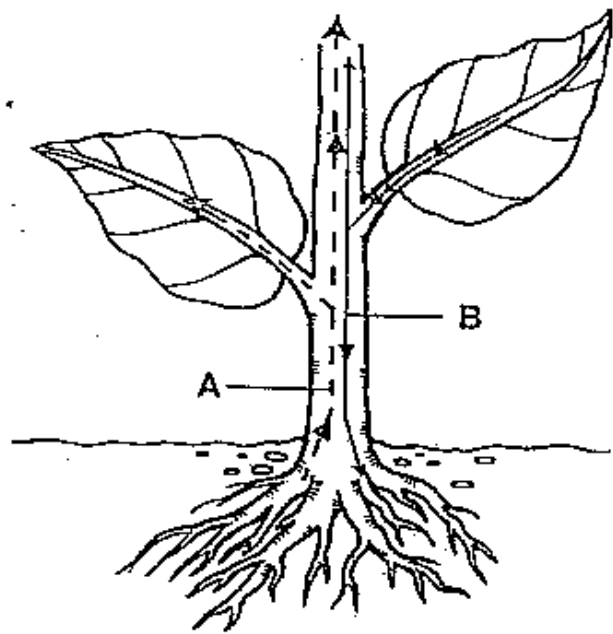

- (a) Tube A carries _____ from the roots to the other parts of the plants. [1]
- (b) Tube B carries _____ from the leaves to the other parts of the plant. [1]
- (c) Name the green substance found in the leaves which enables it to trap the energy of sunlight. [1]

29 The diagram shows a lotus plant.

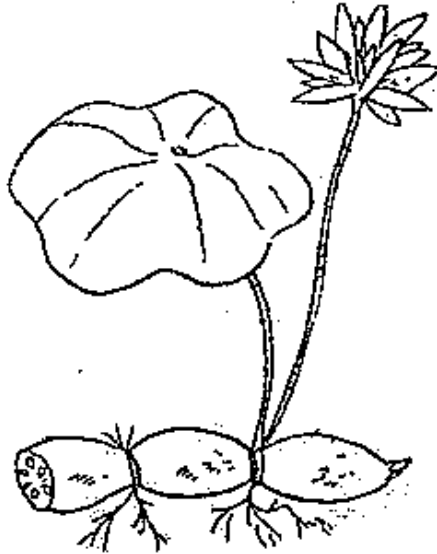

- (a) Draw an arrow pointing to the plant part that takes in mineral salts. [1]
- (b) Circle the part that can develop into a fruit. [1]
- (c) The water lily plant is another flowering plant which lives in the water. What is another way in which the lotus plant is similar to the water lily plant? [1]

30 The diagrams show 3 boys doing 3 different activities.

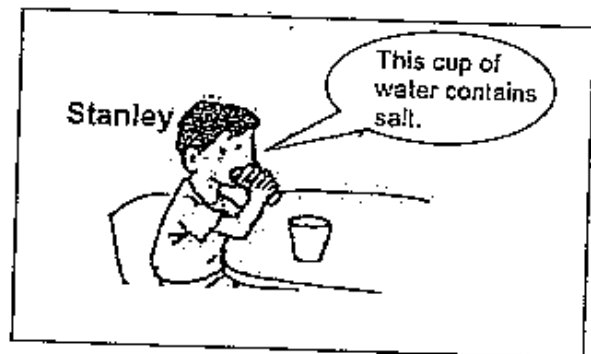
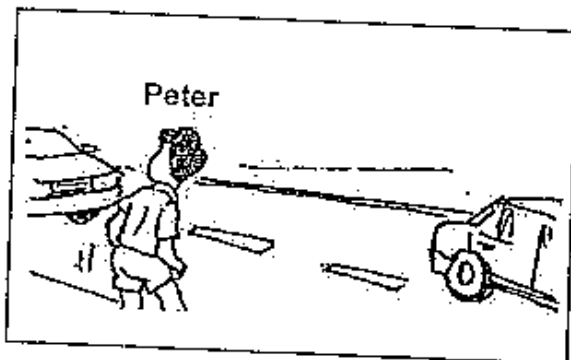
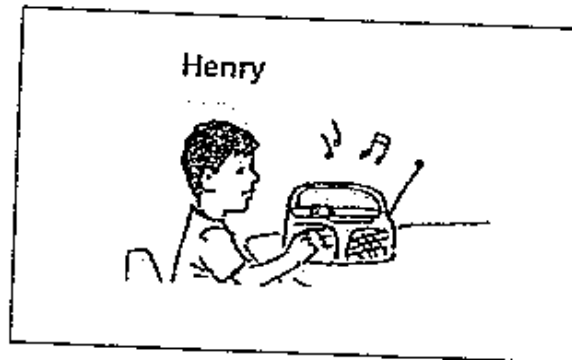

(a) Which boy is doing an activity in which the sense of sight is most important?

[1]

(b) Which sense enables Stanley to tell which cup of water contains salt?

[1]

(c) Explain how a blind person can still enjoy the same activity as Henry.

[1]

31 Draw lines to match the body systems to their functions.

[2]

Circulatory System

Breaks down food into simple substances.

Respiratory System

Carries waste material away from different parts of the body.

Digestive System

Takes in oxygen and removes carbon dioxide.

Skeletal System

Supports the body.

32 The diagram shows a skeleton of an animal.

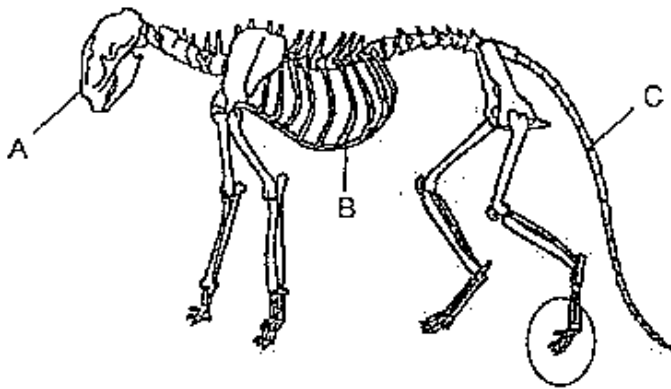

(a) Which bone (A, B or C) does not protect an organ? [1]

(b) The bone that is circled supports the animal and helps it to move. What is another function of the bone? [1]

(c) What is the difference in the function of bone A and B? [1]

33 Sam put three ring magnets onto a rod as shown below. Two of the magnets 'floated' as shown in the diagram.

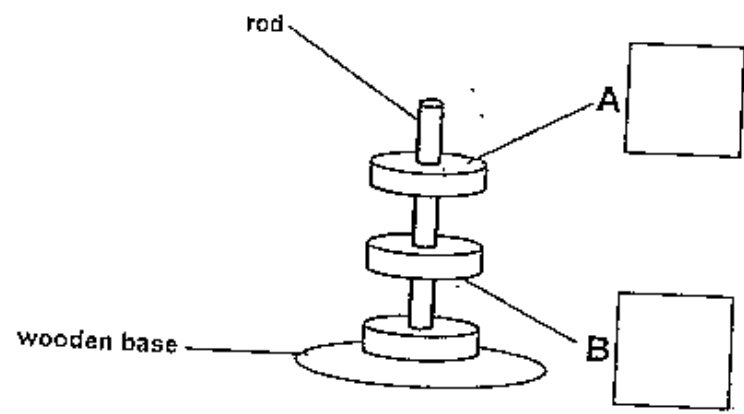

(a) in the diagram, label the poles A and B by writing N or S in each box. [1]

(b) What material is the rod made of? [1]

- 34 A magnet was placed next to some pins. Soon it was observed that the pins could be attracted.

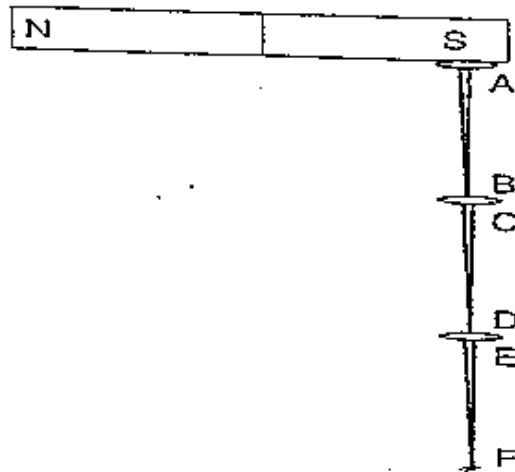

- (a) Why was pin CD able to attract pin EF? [1]

- (b) The south pole of another magnet was brought close to F. What would happen to pin EF? Why? [1]

35 Meimei was playing with the items below and observed that only C and E were attracted to a magnet.

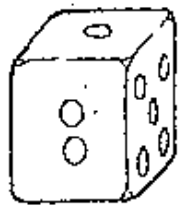

A



B



C



D

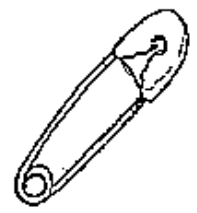

E

(a) From her observation, what can Meimei tell about A, B and D. [1]

(b) Meimei says that if she wrapped C and E in paper, the magnet would not be able to attract them. Do you agree with her? Why? [1]

36 Sally prepared the set-up below.

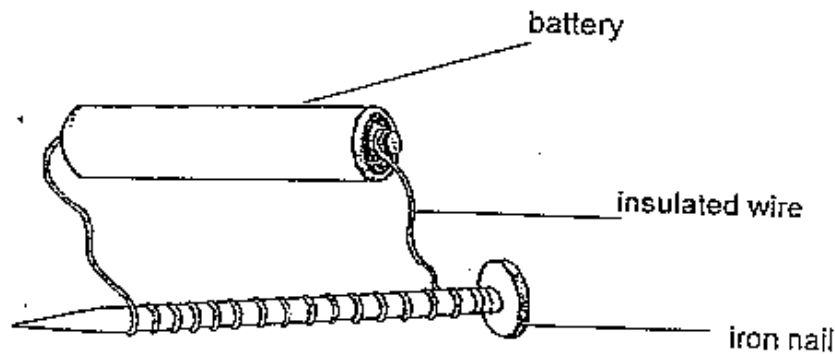

(a) What will the nail become?

[1]

(b) She found that the nail could attract 4 paper clips. Without using any new materials, what can she do to the set up so that the iron nail can attract more than 4 paper clips?

[1]

- 37 Alice used 2 magnets and 2 iron nails to test if she could make the nails into magnets.

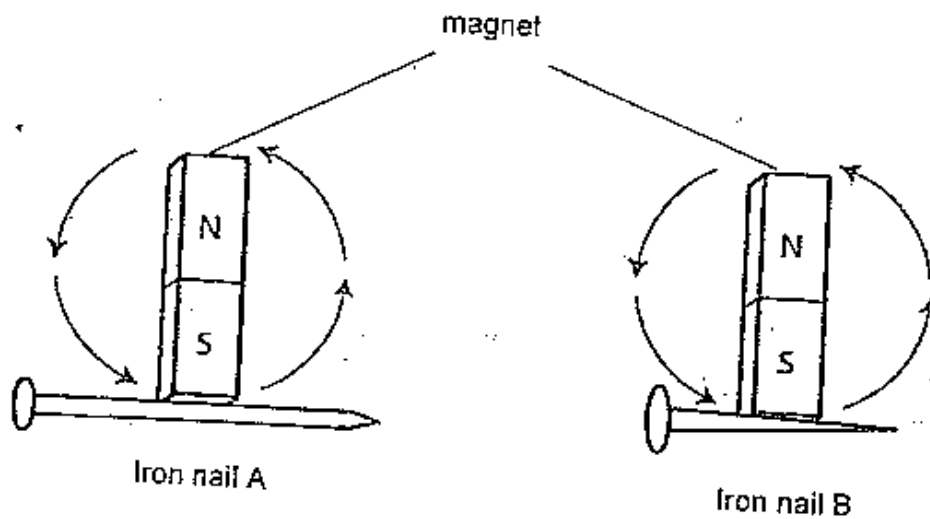

- (a) How can she prove that nail A and B have become magnets? [1]

- (b) She is given 50 paper clips. How can she find out if nail A has become a stronger magnet? [2]

38 The pictures show some common objects used in our daily lives.

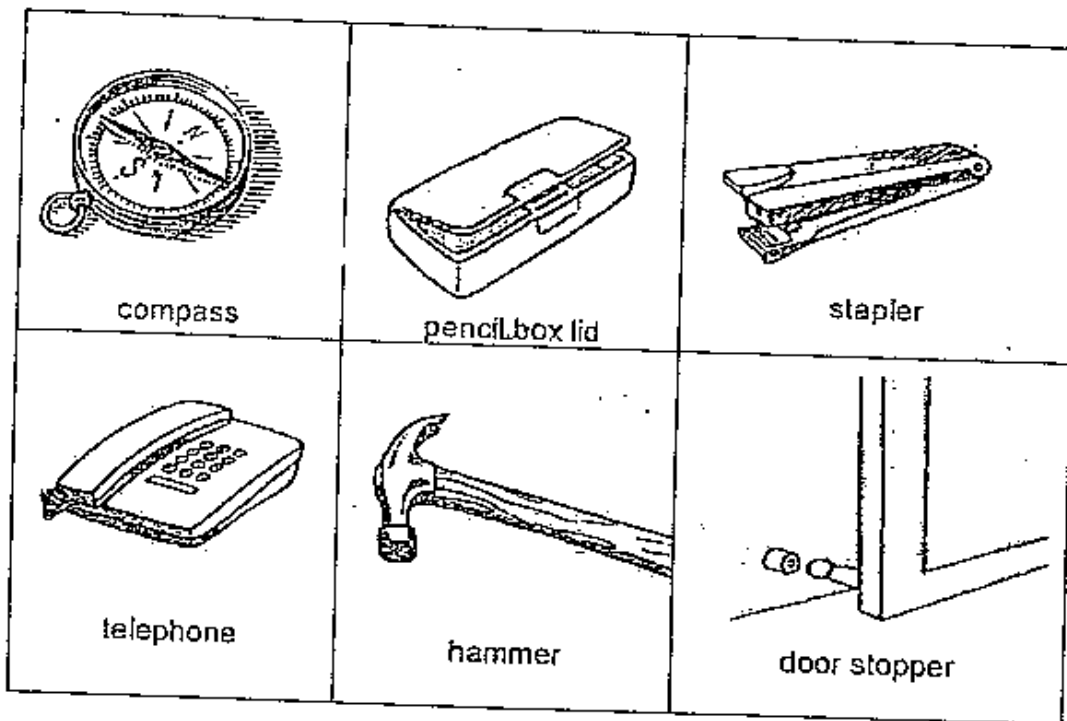

(a) Circle the objects that make use of magnets. [2]

(b) In which of the objects is the magnet used to show direction? [1]

(c) What could have happened to a magnet to make it lose its magnetism? [1]

⊙ End of Paper ⊙

81

--

Answer Sheets
Anglo Chinese Pri 3 SA2 / 2006 Science

1) 4	2) 3	3) 4	4) 2	5) 4
6) 2	7) 1	8) 3	9) 4	10) 3
11) 3	12) 3	13) 2	14) 2	15) 3
16) 3	17) 3	18) 3	19) 4	20) 2

- Q21a. Bottle C
b. It has air, water and food.

- Q22a. Shell : snail
Hair : wolf, kangaroo
Scales : scales
Feathers : turkey, emu
b. Yes. Because its body covered with shell.

- Q23. Box A ; Metal rod
Box B : Rubber ring
Box C : Clay tile
Box D : Glass sheet

- Q24. Many plants have seeds which can grow into seedlings. When the conditions are right, a seed can germinate or start to grow. First the root grows, then the shoot appears. In the beginning the seedling gets its food from the seed. When the leaves develop, the seedling starts making its own food. It grows to become an adult.

Q25a.

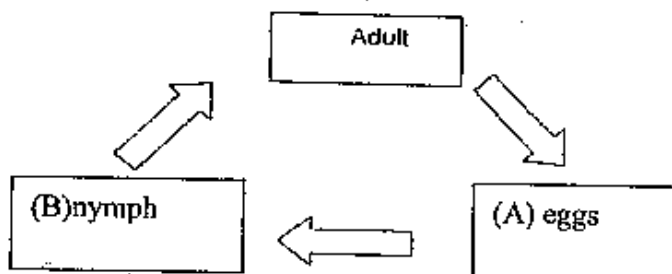

- b. Adult stage.

- Q26.a Similarity : Both have 3 stages of life cycles.
 b. Different : Chick resembles its parent but Frog does not resemble its parent.
 c. Whale

- Q27.a. John has no brothers.
 b. John has two aunts.
 c.

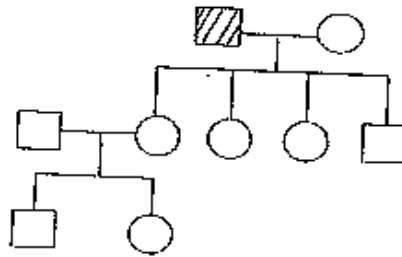

- Q28.a. Tube carries water and mineral salts from the roots to the other parts of the plants.
 b. Tube B carries food from the leaves to the other parts of the plant.
 c. Chlorophyll.

Q29a



- c. Both are partially submerged.

- Q30.a. Peter
 b. Sense of Taste
 c. Sense of hearing by using his sense of ear.

Q31.

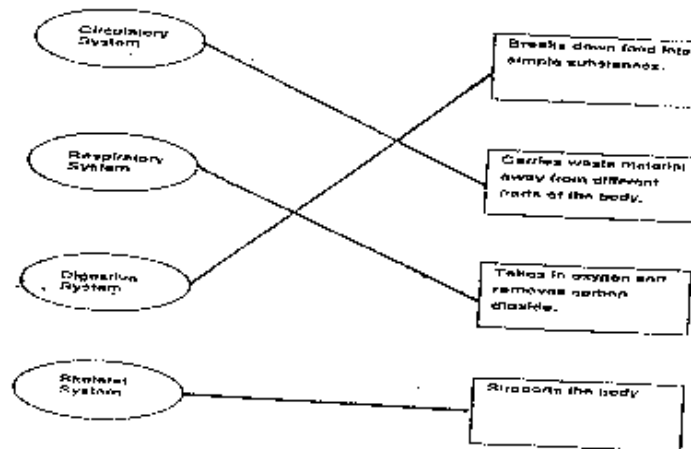

- Q32a. Bone C
 b. Its give it shape
 c. Bone A is a skull. It protects our brain, eyes and tongue .
 Bone B is our chest ribs. It protect our heart and lungs

Q33a.

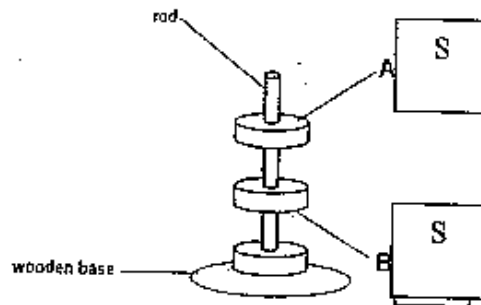

- b. The rod is made of wood.
- Q34a. It is magnetism.
 b. It will repelled.
- Q35a. They are non-magnetic objects.
 b. No. It is because magnetic object can still pass through the paper..
- Q36a. The nail becomes electromagnet.
 b. Increased the number of turns of the insulated wire around the nail.
- Q37a. Stroke both the iron nail several times with a magnet. The magnetized nail is then able to attract magnetic substances.
 b. If nail A attracts the most paper clips, then it the stronger magnet than nail B.

Q38a.

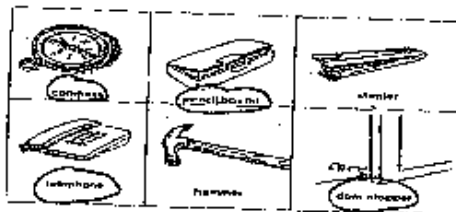

- b. Compass
 c. The magnetism can be lost by heating it, dropping it a few times and by hitting it a few times with a hammer.