

RIVER VALLEY PRIMARY SCHOOL
SEMESTRAL ASSESSMENT 2 / 2016
PRIMARY 3
SCIENCE
(BOOKLET A)

Name : _____ ()

Date : 1st November 2016

Class : P3 _____

Total Time for Booklet A & Booklet B : 1 hour 30 mins

INSTRUCTIONS TO CANDIDATES

1. Write your name, index number and class in the space above.
2. Do not turn over this page until you are told to do so.
3. Follow all instructions carefully.
4. Answer all questions.
5. For Section A, shade your answers for questions 1 to 15 in the Optical Answer Sheet (OAS) provided.
6. For Section B, write your answers for questions 16 to 23 in the space provided in the booklet.
7. The total marks for Booklet A is 30 marks.

Section A (30 marks)

For each question 1 to 15, four options are given. One of them is the correct answer. Make your choice (1, 2, 3 or 4). Shade the oval (1, 2, 3 or 4) on the Optical Answer Sheet.

1. The table below shows the characteristics of 4 different things.

Things	Able to move from place to place	Needs water	Lays eggs	Has legs
A	Yes	Yes	Yes	No
B	Yes	Yes	No	Yes
C	Yes	No	No	No
D	No	No	No	Yes

Which of the following is/are living thing(s)?

- (1) A only
- (2) B only
- (3) A and B only
- (4) B, C and D only

2. The chart below shows that the number of butterflies have increased over 5 months.

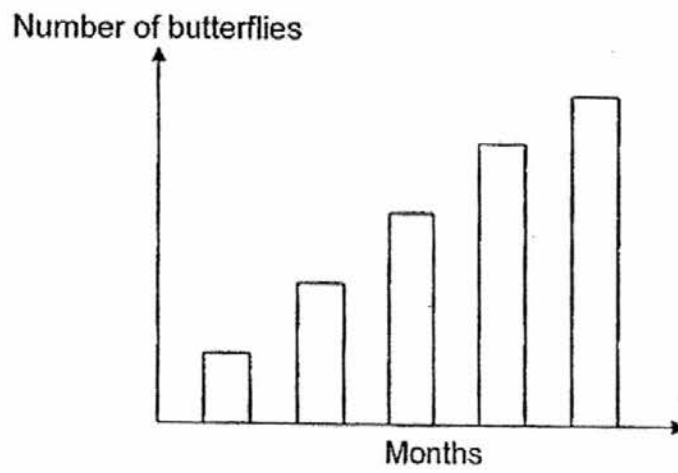

This shows that butterflies can _____.

- (1) grow
- (2) reproduce
- (3) take in food
- (4) respond to changes around it *

3. The table shows how some plants have been classified.

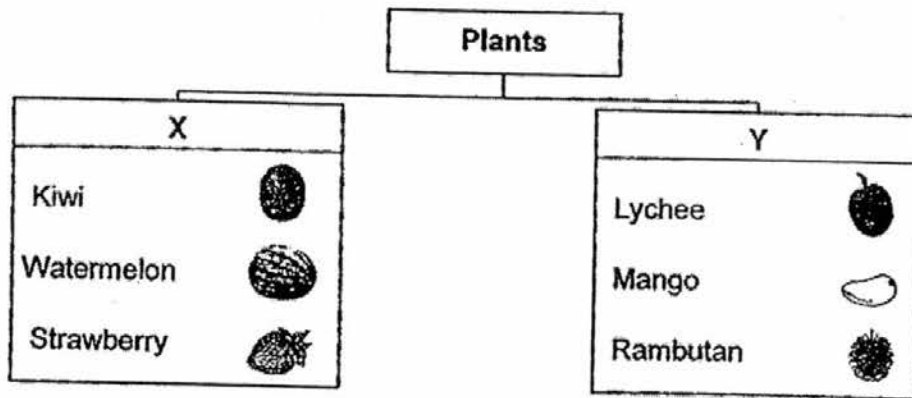

Which of the following is/are likely to be X and Y?

	Heading 1	Heading 2
(1)	Edible	Not Edible
(2)	Non-flowering	Flowering
(3)	Rough skin	Smooth skin
(4)	Many seeds	One seed

4. Alice classified some things into Group Y and Group Z.

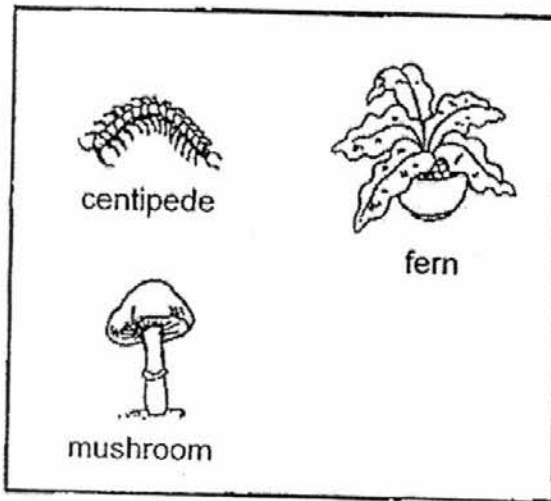

Group Y

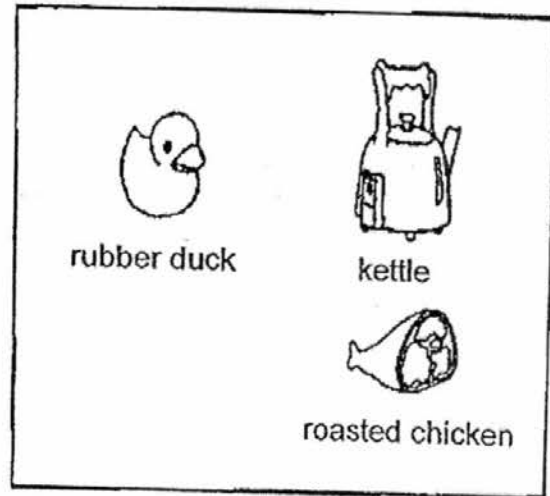

Group Z

Which of the following statements best explain how these things are classified?

	Group Y	Group Z
A	They are alive.	They were once alive.
B	They can make food.	They cannot make food.
C	They are living things.	They are non-living things.
D	They can respond to changes.	They cannot respond to changes.

- (1) A and B only
- (2) B and C only
- (3) C and D only
- (4) B, C and D only

5. Study the diagram below carefully.

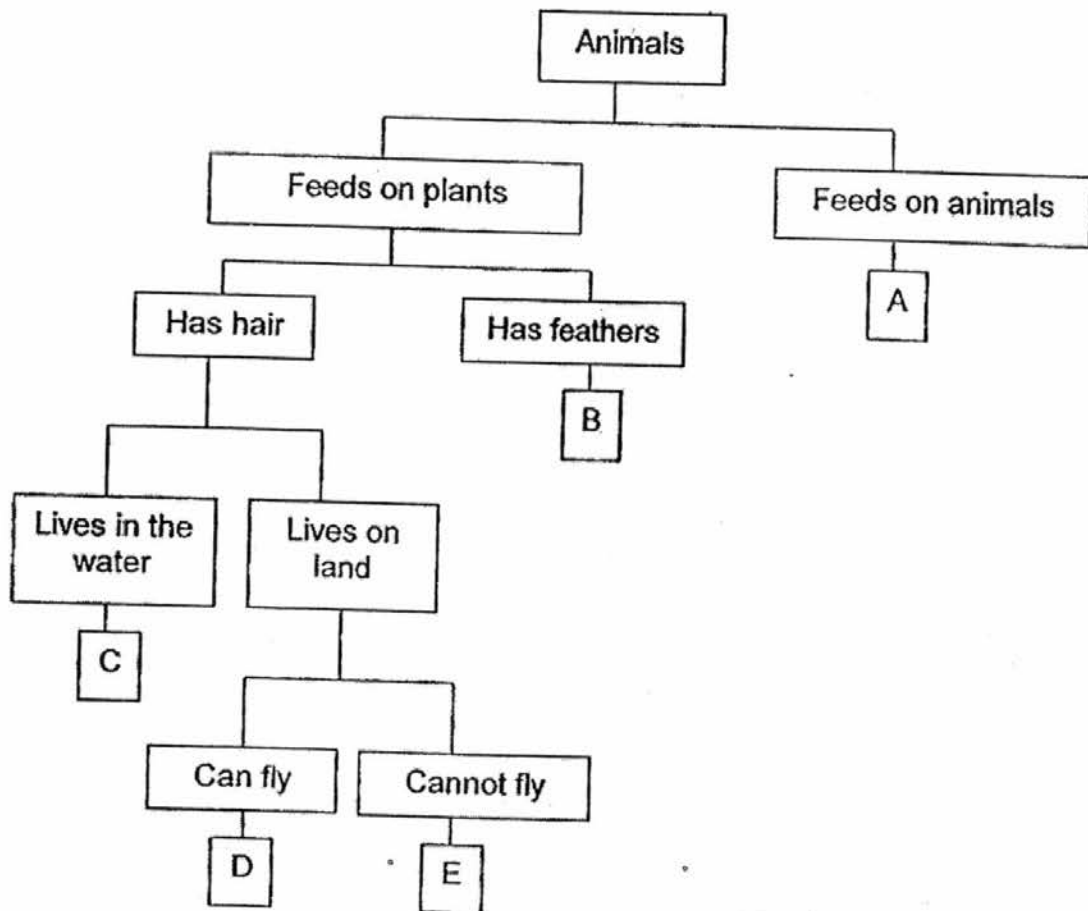

According to the diagram above, which of the following statements are correct?

- (1) A and E are mammals.
- (2) D and E feed on animals.
- (3) B and D make their own food.
- (4) C and E have the same type of outer body covering.

6. Gary wanted to group the animals shown below into two groups.



chicken



lion



platypus



seal



eagle



giraffe

If there are only three animals in each group, which of the following is the most appropriate heading?

	Group 1	Group 2
(1)	Mammals	Birds
(2)	Can fly	Cannot fly
(3)	Lays eggs	Gives birth to young
(4)	Has feathers	Does not have feathers

7. The flow chart below shows the characteristics of X.

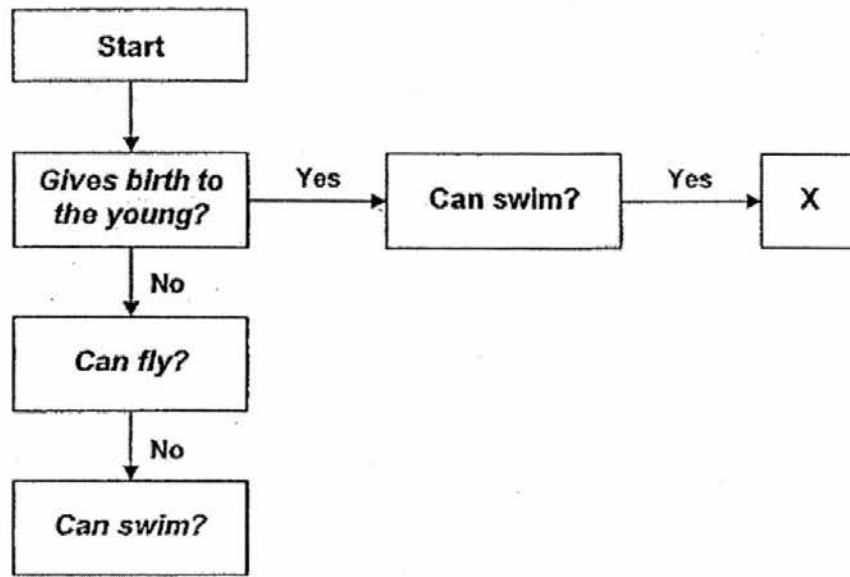

X is most likely a _____.

- (1) mammal
- (2) plant
- (3) bird
- (4) insect

8. The diagram shows the roots of two plants.

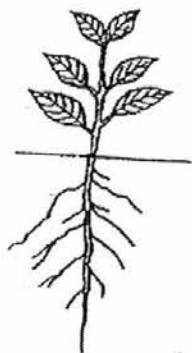

Roots of Plant A

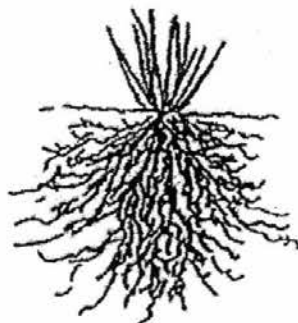

Roots of Plant B

Comparing Plant A with Plant B, the roots of Plant B can _____.

- A: trap more sunlight
- B: absorb more water
- C: hold the plant more firmly to the ground
- D: transport more food to the other parts of the plant

- (1) C only
- (2) B and C only
- (3) A, B and D only
- (4) A, B C and D only

9. 3 similar plants were placed in black boxes and put in an open field.
Holes were made on different parts of the boxes.

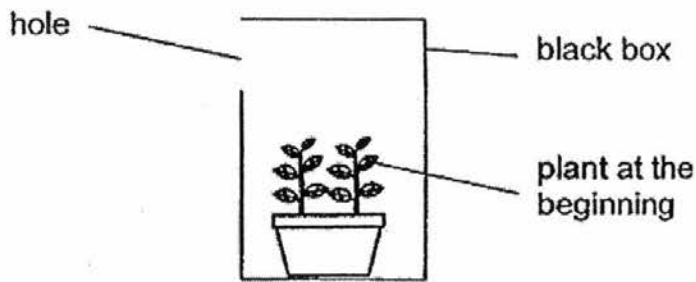

The diagram below shows what the plants looked like after 1 week.

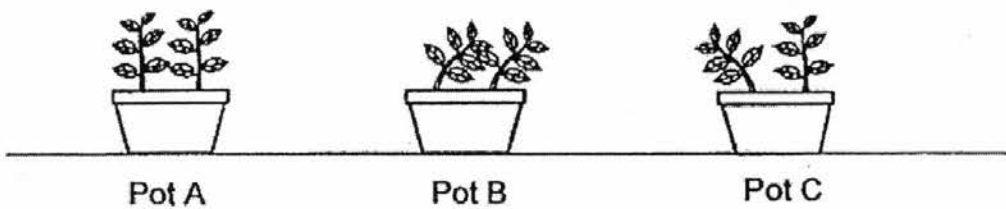

Which one of the following correctly shows the set-ups at the start of the experiment?

	Pot A	Pot B	Pot C
(1)			
(2)			
(3)			
(4)			

10. Look at the picture of the mushroom below carefully.

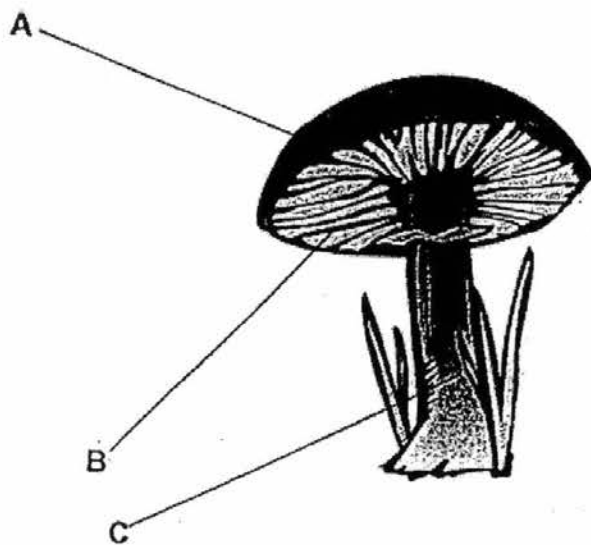

What are parts A, B and C?

	A	B	C
(1)	Gills	Spores	Stalk
(2)	Cap	Gills	Stalk
(3)	Stalk	Gills	Cap
(4)	Cap	Spores	Gills

11. The pictures below show the different stages in the life cycle of a plant.



Which of the following shows the correct life cycle of a plant?

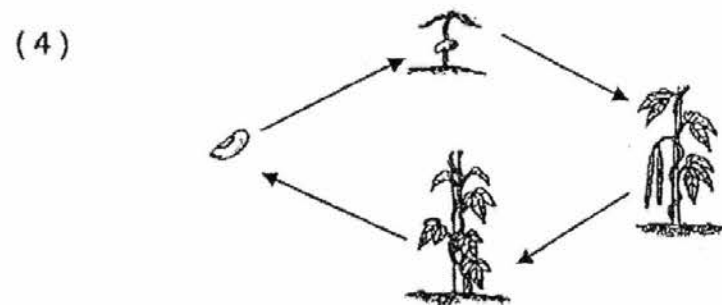
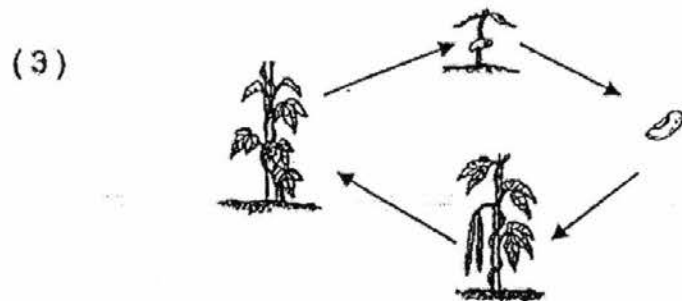
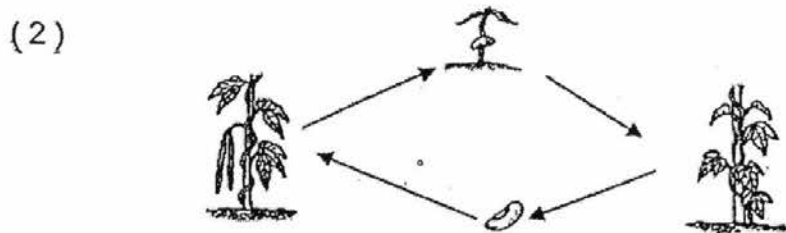
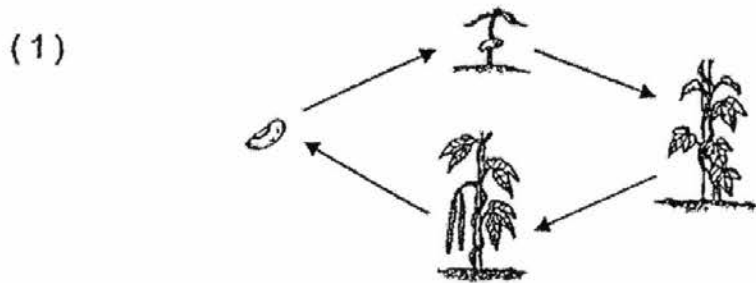

12. Which of the following live in water at one stage and on land at another stage of its life cycle?

Animal A: Mosquito



Animal B: Chicken

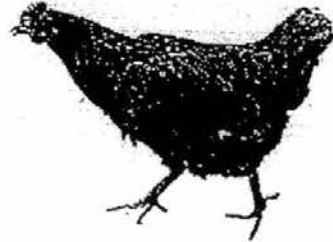

Animal C: Frog

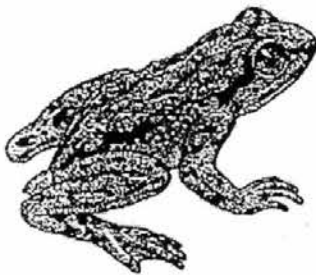

Animal D: Cockroach

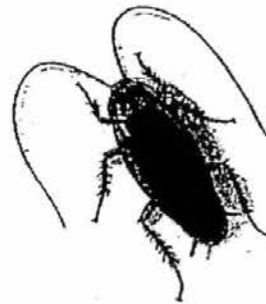

- (1) A and B only
- (2) A and C only
- (3) B and C only
- (4) A, C and D only

13. Anna placed a ball in a box and covered the box. She made a hole at the side and light could only enter through the hole. Then, she looked through the hole but could not see the ball inside the box.



Which one of the following statement(s) explains why she is not able to see the ball in the box?

- (A) There is not enough light in the box.
 - (B) The ball cannot reflect light to Anna's eyes.
 - (C) The ball does not allow light to pass through.
-
- (1) A only
 - (2) A and B only
 - (3) B and C only
 - (4) A, B and C

14. Look at the diagrams below.

Which one of the following diagrams shows the correct position of the sun?

(1)

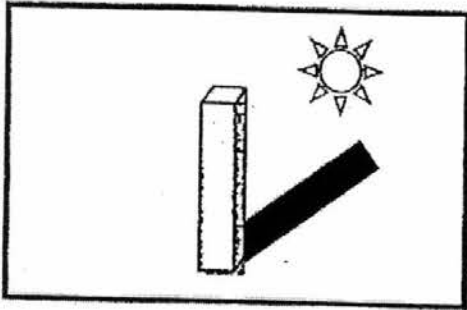

(2)

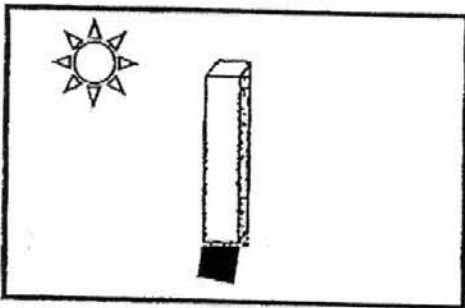

(3)

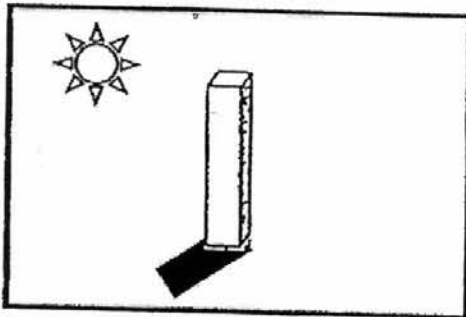

(4)

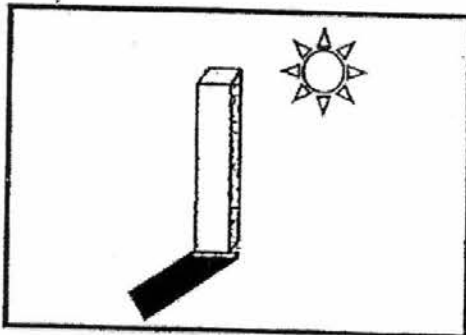

15. The diagram below shows a freely suspended bar magnet.

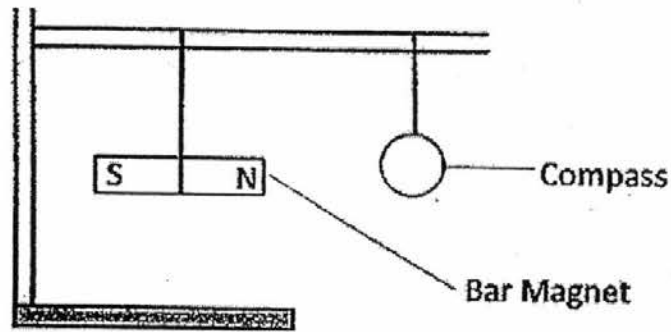

Which of the following diagrams shows the correct direction in the compass if it is placed beside the bar magnet?

(1)

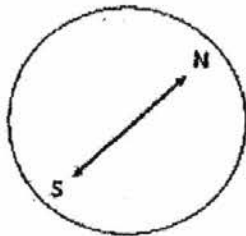

(2)

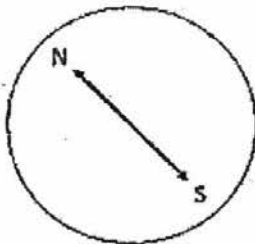

(3)

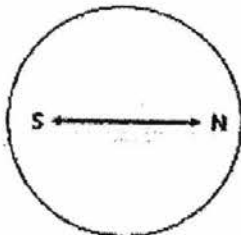

(4)

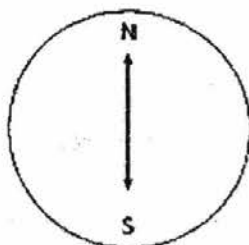

~End of Section A~

RIVER VALLEY PRIMARY SCHOOL
SEMESTRAL ASSESSMENT 2 / 2016
PRIMARY 3

SCIENCE

(BOOKLET B)

Name : _____ ()

Date : 1st November 2016

Class : P3 _____

Total Time for Booklet A & Booklet B : 1 hour 30 mins

INSTRUCTIONS TO CANDIDATES

1. Write your name, index number and class in the space above.
2. Do not turn over this page until you are told to do so.
3. Follow all instructions carefully.
4. Answer all questions.
5. For Section A, shade your answers for questions 1 to 15 in the Optical Answer Sheet (OAS) provided.
6. For Section B, write your answers for questions 16 to 23 in the space provided in the booklet.
7. The total marks for Booklet B is 20 marks.

Booklet A		/30
Booklet B		/20
Total		/50
Parent's Signature		

Section B (20 marks)

Write your answers to questions 16 to 23 in this booklet.

16. Study the diagram of a plant below.

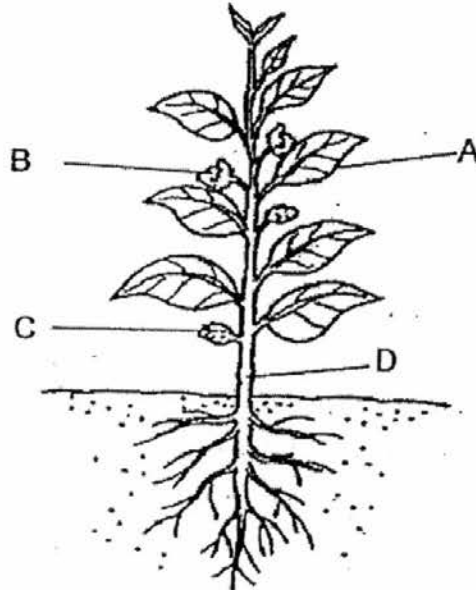

(a) Name the parts in the diagram above. [2]

A: _____

B: _____

C: _____

D: _____

(b) In an experiment, Part A of the plant was removed. The plant died after a few days. Explain how this is possible. [1]

	3
--	---

17. Study the flowchart below.

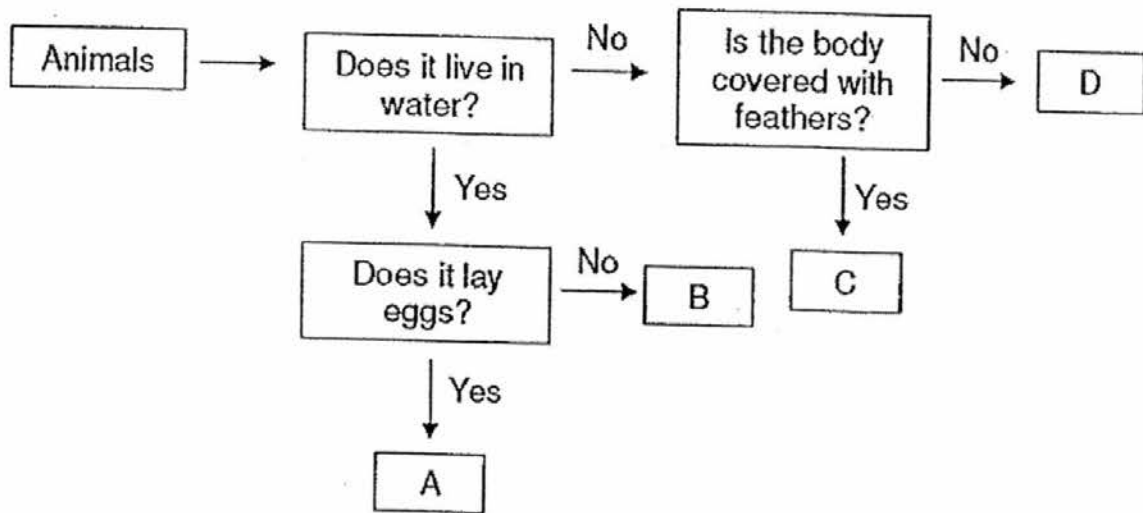

(a) Identify the letters (A, B, C and D) in the flowchart that represent each of the following animals. [2]

Animal	Letter
Dog	
Guppy	
Goldfish	
Parrot	

(b) Based only on the information given in the flowchart, what are the characteristics of C? [1]

	3
--	----------

18(a) Read the following information on ways to reduce mosquito breeding in our homes.

Key Steps to Reduce Mosquito Breeding

- Change the water in vases/bowls every two days.
- Remove the water from flower pot plates every two days.

(Source: www.dengue.gov.sg)

(i) At which stage or stages of the life cycle of the mosquito would the above steps be effective in reducing its breeding? Put a tick (✓) in the correct box/boxes. [1]

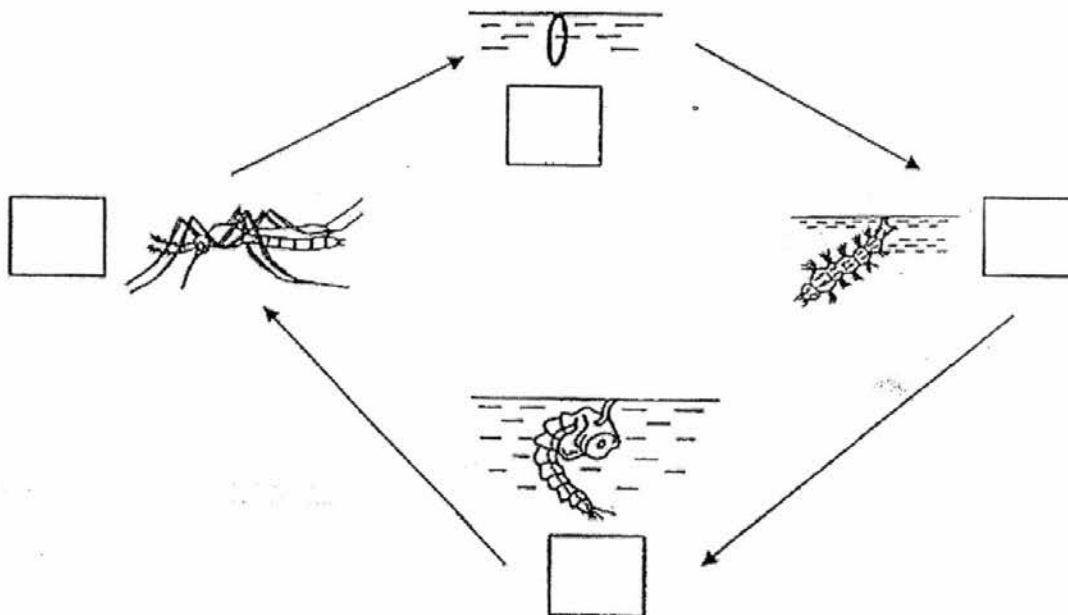

(ii) From the information given above, what causes the breeding of mosquitoes? [1]

	2
--	---

- (b) There are three stages of the dragonfly's life cycle; the egg, the nymph and the adult dragonfly. A large part of the life cycle of a dragonfly is at the nymph stage in the water.

The following information was obtained from the newspapers.

"Dragonflies can help control the population of dengue-carrying mosquitoes here," said Mr Robin Ngiam, a senior project officer of National Parks Board (NParks).

How do dragonflies help to control the population of dengue-carrying mosquitoes? [1]

	1
--	---

19. Study the three groups of animals in the classification table below.

Types of Body Covering		
Group X	Group Y	Group Z
Snail	Bat	Komodo Dragon
Turtle	Penguin	Snake
Crab	Bear	Guppy

(a) Which animal is classified wrongly? [1]

(b) Explain your answer in part (a). [1]

	2
--	---

20. Ryan set up the experiment as shown below. She changed the distance between the torch and the container.

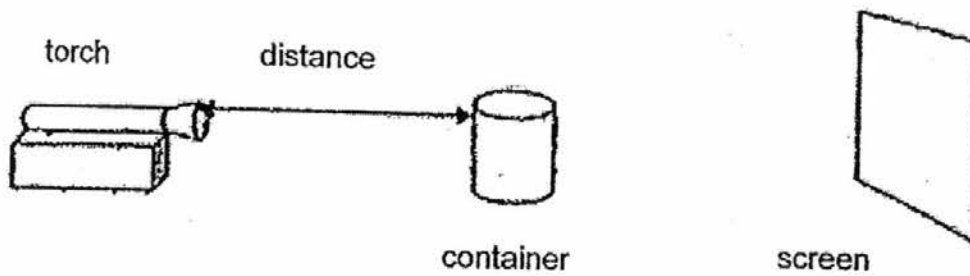

The table below shows the results of Ryan's experiment.

Distance between the torch and container (cm)	Height of the shadow on the screen (cm)
20	?
15	8
10	10
5	12

(a) In the space given below, draw the shadow formed on the screen. [1]

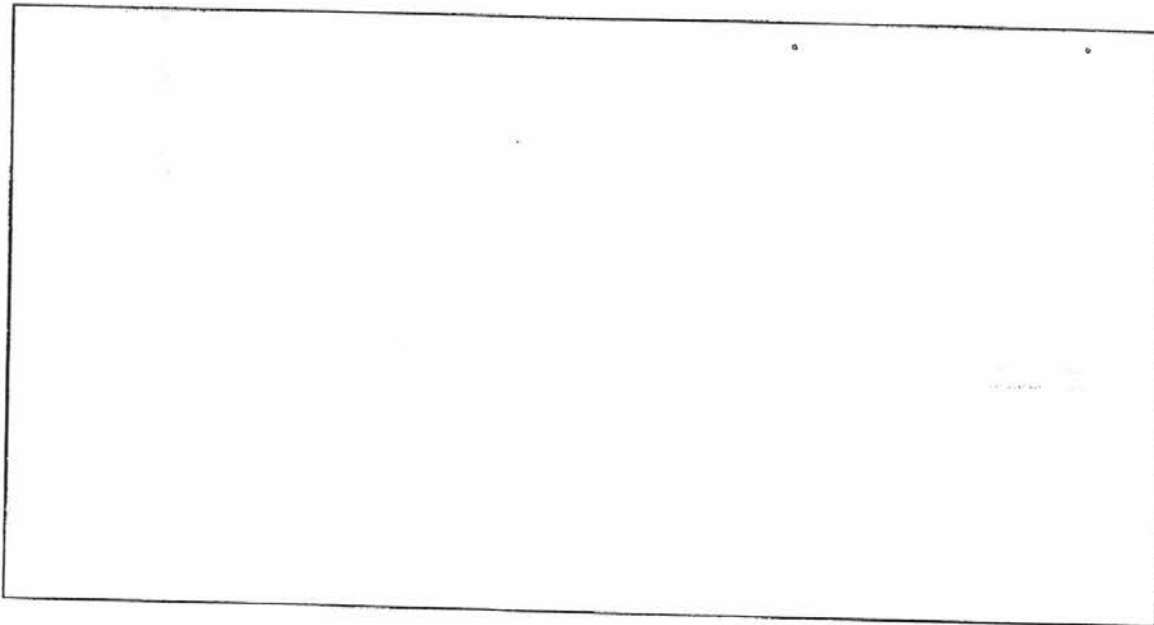

	1
--	----------

(b) Predict the height of the shadow on the screen if the torch is placed 20 cm away from the container. [1]

(c) What can he do to decrease the height of the shadow without moving the position of the container? [1]

	2
--	---

21. Min held an umbrella and stood directly under a lighted lamp post. He could only see the shadow cast by the umbrella instead of his own shadow.

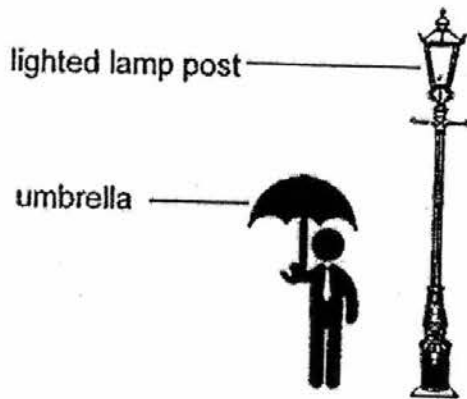

Explain why he was not able to see his own shadow. [1]

	1
--	---

22. The diagram below shows an experiment carried out by Devi using ring magnets A and B.

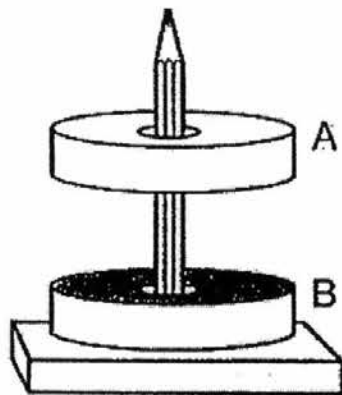

- (a) Explain why Magnet A is able to float. [1]

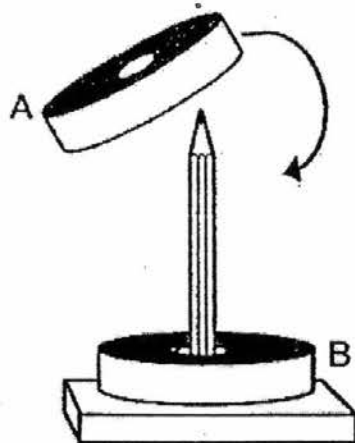

- (b) If Magnet A is turned over and placed through the pencil, what will happen to both the magnets? [1]

	2
--	---

23. Ren conducted an experiment using the set-up of an electromagnet below.

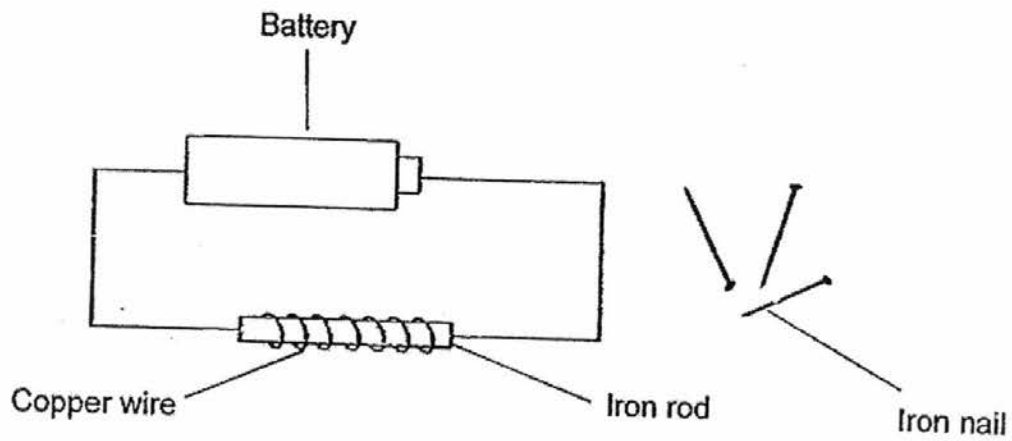

(a) State what Ren would observe if he placed some iron nails near the iron rod. [1]

(b) Suggest one change Ren could do to the set-up so that the electromagnet could pick up more iron nails. [1]

(c) Ren removed the copper wire from the iron rod and placed the rod near some iron nails. He observed that the iron nails did not move. Give a possible explanation for this observation. [1]

	3
--	---

~End of Paper~

EXAM PAPER 2016 (P3)

SCHOOL : RIVER VALLEY

SUBJECT : SCIENCE

TERM : SA2

Q1	Q2	Q3	Q4	Q5	Q6	Q7	Q8	Q9	Q10
3	2	4	3	4	3	1	2	2	2
Q11	Q12	Q13	Q14	Q15					
1	2	2	4	3					

16)a)A: Leaves B: Flower C: Seedling D: Stem

b)Part A does not have leaves to make food for the plant.

17)a)D , B , A ,C

b)C does not live in water and its body is covered with feathers.

18)a)i)

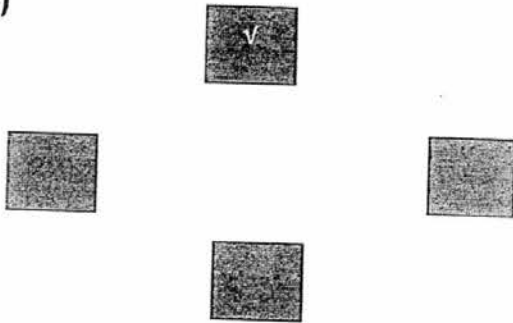

ii)Mosquitoes breed in stagnant water.

18)b)The dragonfly nymphs feeds on the eggs of the mosquitoes.

19)a)Penguin.

b)Bear and bat have hair ad their body covering but penguin has feathers.

20)a)



b)6cm

c)Move the screen nearer to the container.

21)Umbrella blocked the light.

22)a)Like poles of magnet A and B are facing each other so they repel and magnet A is able to float above magnet B.

b)Both of the magnets will attract each other.

23)a)The iron rod will attract the iron nails.

b)Increase the number of strokes.

c)The electromagnet has lost its magnetism.